

Registered Office  
"Maithri"  
132, Cathedral Road,  
Chennai 600 086, India.  
CIN: L74999TN1972PLC006127

Tel: 91 44 2811 2472  
URL: [www.ranegroup.com](http://www.ranegroup.com)

## Rane Engine Valve Limited



**// Online submission //**

REVL / SE / 037 / 2024-25

August 04, 2024

<b>BSE Limited</b> <b>Listing Centre</b> Scrip Code: <b>532988</b>	<b>National Stock Exchange of India Ltd.</b> <b>NEAPS</b> Symbol: <b>RANEENGINE</b>
--------------------------------------------------------------------------	-------------------------------------------------------------------------------------------

Dear Sir / Madam,

**Sub: Earnings Presentation – Quarterly Unaudited Financial Results for the quarter ended June 30, 2024**

We enclose herewith copy of the Earnings presentation released on the quarterly Unaudited Financial Results for the quarter ended June 30, 2024.

This is also being made available on the Investor Information Section of the website of the Company at the web-link <https://ranegroup.com/investors/rane-engine-valve-limited/>.

We request you to take the above on record and note the compliance with SEBI (Listing Obligations and Disclosure Requirements) Regulations, 2015 (SEBI LODR).

Thanking you,

Yours faithfully,

For **Rane Engine Valve Limited**

S Anand  
**Secretary**

Encl: a/a

# **Rane Group**

---

Earnings Presentation | Q1 FY25

# Table of Contents

Q1 FY25 Financial & Operational Performance

Rane Group Overview



# Rane Group

## Q1 FY25 Financial & Operational Performance



To become the Preferred Trusted Supplier of Safety & Critical Auto Components

## Strategic pillars of growth

---

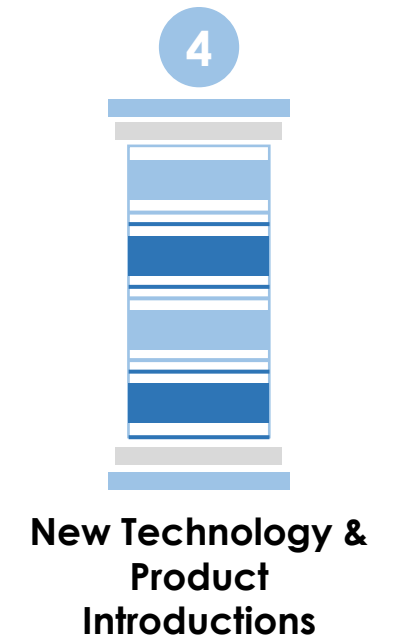
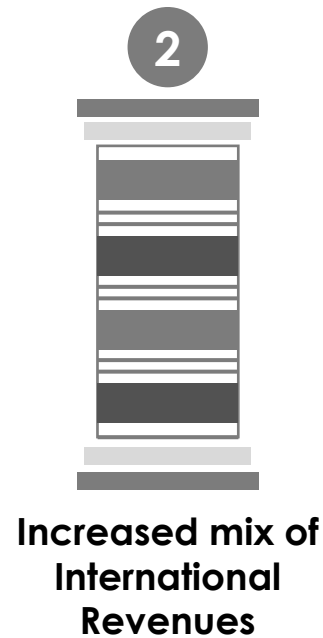

## Business Drivers

- › **92%+ of revenue comes from powertrain agnostic products**
- › **Continued dominance on domestic market across major products**
- › **Increasing export mix for steering & linkages, valve train components and occupant safety products**
- › **Renewed focus on Aftermarket segment leveraging group level synergy**
- › **Continuous new product introductions leveraging strong in-house engineering capabilities**
- › **Increasing efficiencies across manufacturing facilities through operational excellence and digitalization.**

## RANE BRAKE LINING

- Won orders for Rs. 3 Cr from various domestic customers for PV application
- Won Rs. 3 Cr order for EPB in domestic EV application
- Won order worth Rs. 2 Cr from domestic customers for 2W application
- Won order worth Rs. 3.5 Cr from International aftermarket customers

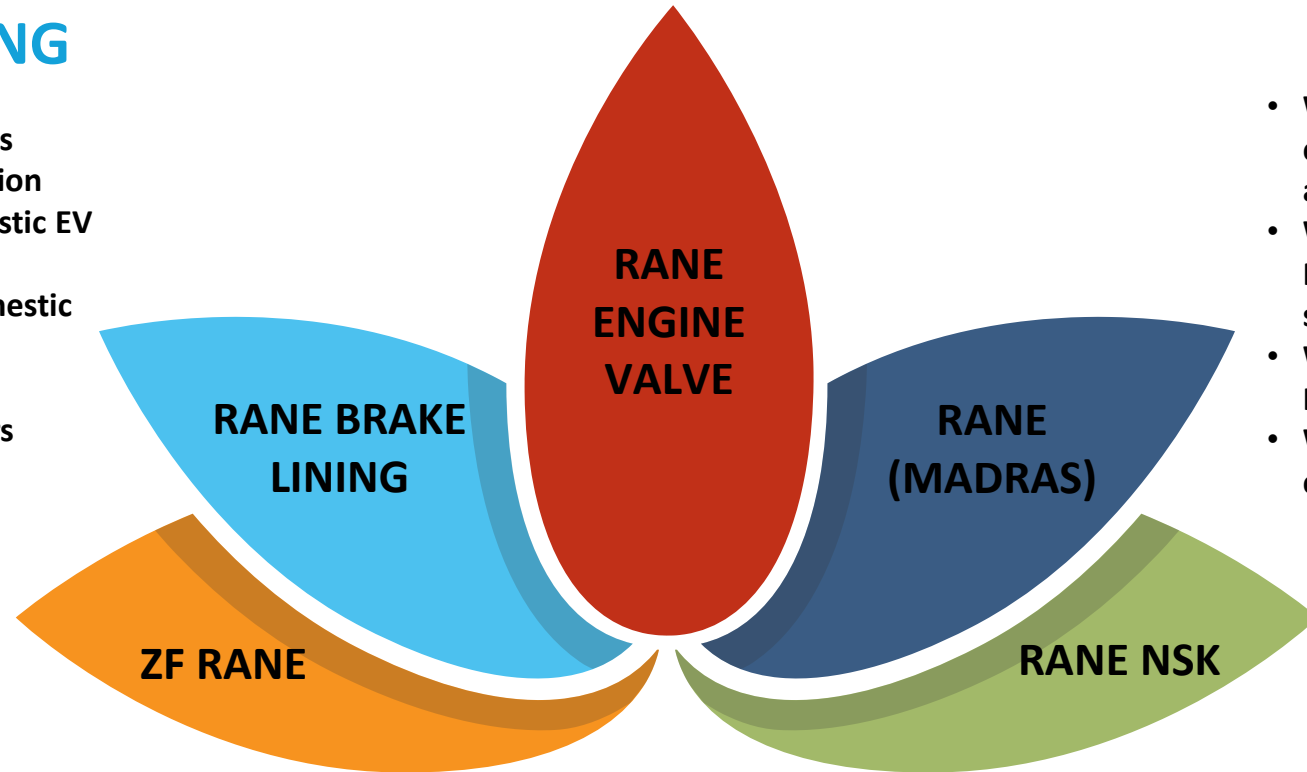

## RANE (MADRAS)

- Won Rs. 40 Cr order from International customer for ball joint components for PV application
- Won Rs. 10 Cr order from various domestic Farm Tractor customers for steering and suspension components
- Won Rs. 8 Cr order for R&P from International customer for ATV segment
- Won Rs. 5 Cr order for RCB from domestic customer for an EV SCV application

## ZF RANE

- Won Rs. 27 Cr order for steering gear from domestic LCV customers
- Won order worth Rs. 1 Cr from domestic CV customer for EV bus application

## RANE ENGINE VALVE





- Won Rs. 1 Cr order from domestic customer for Farm Tractor segment

## RANE NSK

- Won orders worth Rs. 30 lakhs from domestic CV customer for EV Bus application

**Won new business worth Rs. 104 Cr during Q1 FY25**

# We continue to target higher than the industry growth

Industry Performance Review (Q1 FY25)	 Passenger Vehicle	 commercial Vehicle	 Farm Tractor	 2-Wheeler
Production YoY Growth# in %	6%	-1%	-1%	20%
Rane Group Sales Growth YoY in % (India OEM)	18%	-3%	-8%	10%
Rane Group Revenue Split * (India OEM)	65%	25%	5%	3%
	<ul style="list-style-type: none"> <li>Higher growth than the industry driven by higher growth on served models</li> </ul>	<ul style="list-style-type: none"> <li>Performance is lower than industry due to higher drop in served models</li> </ul>	<ul style="list-style-type: none"> <li>Higher shift to power steering and lower offtake of manual tractors</li> </ul>	<ul style="list-style-type: none"> <li>Lower performance is due to lower offtake of valve train components</li> </ul>

\* Other segments such as Rail, Defence, Stationary Engines and 3-Wheeler contribute around 2%

## Market Commentary

- The growth in PV segment was driven by strong performance in the SUV segment.
- CV segment experienced muted growth due to elections and pause in infrastructure projects.
- The declining trend in the Farm Tractor segment continued in Q1 FY25. The farm sentiments and above normal monsoon expectations have contributed to signs of revival in tractor sales.
- The 2W segment continued its upward trajectory, driven by improved domestic sales.



# Group Aggregate Sales(Q1 FY25)

## Group Aggregate Sales (Rs cr.)

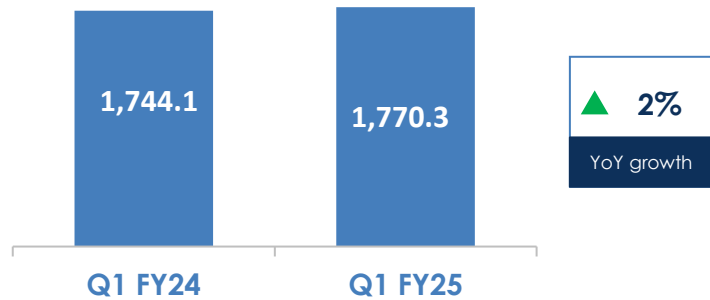

- › Sales increased by 2% from Rs. 1,744.1 Cr in Q1 FY24 to Rs. 1,770.3 Cr in Q1 FY25
- Revenue from Indian OE customers grew 9% supported by strong growth in PV segment
- Revenues from International customers decreased 17% predominantly on account of divestment of LMCA business. On an organic basis it declined by 5% due to end of certain customer programs for steering and occupant safety products
- Revenue from Indian aftermarket segment decreased by 1%

## Group Aggregate Sales (Q1 FY25)

### BY PRODUCT (%)

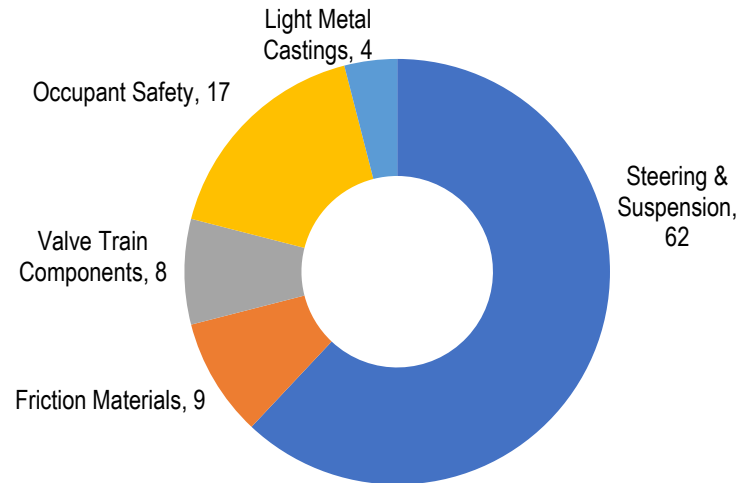

### BY MARKET (%)

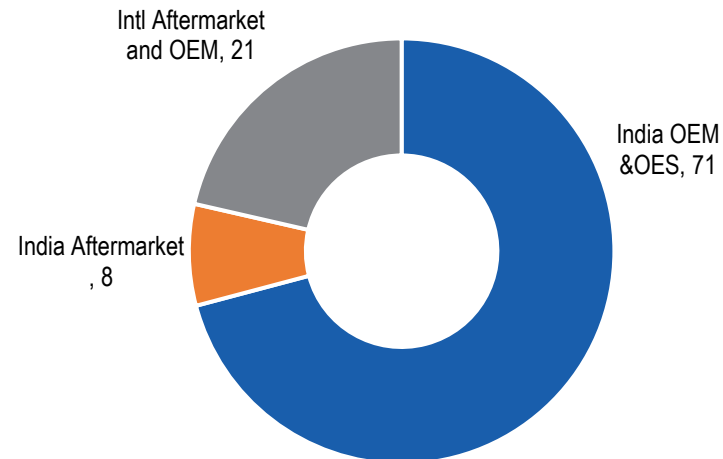

### BY VEHICLE SEGMENT (%)

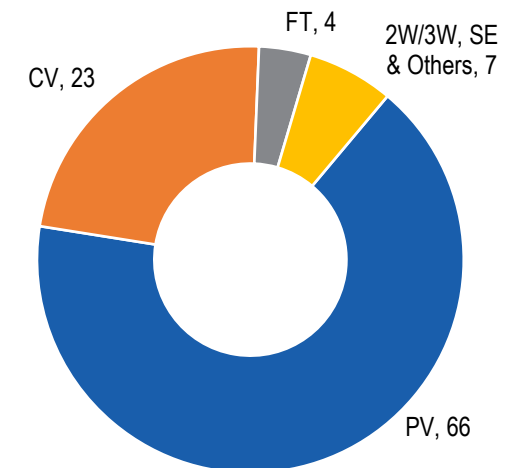

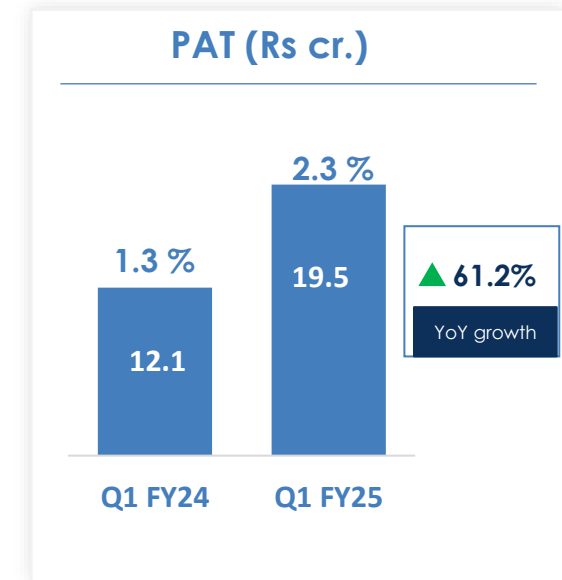
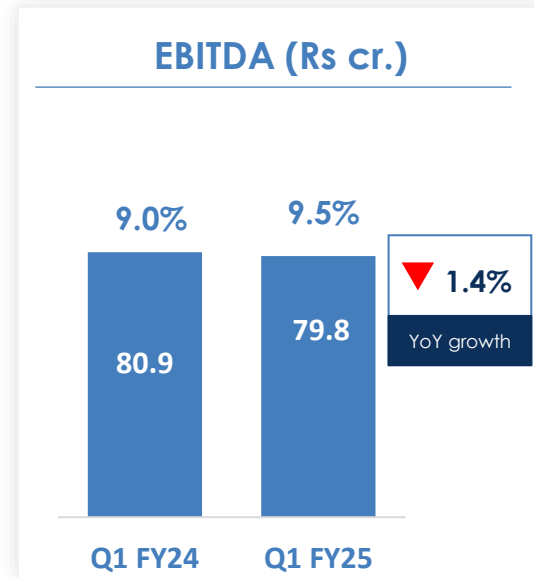
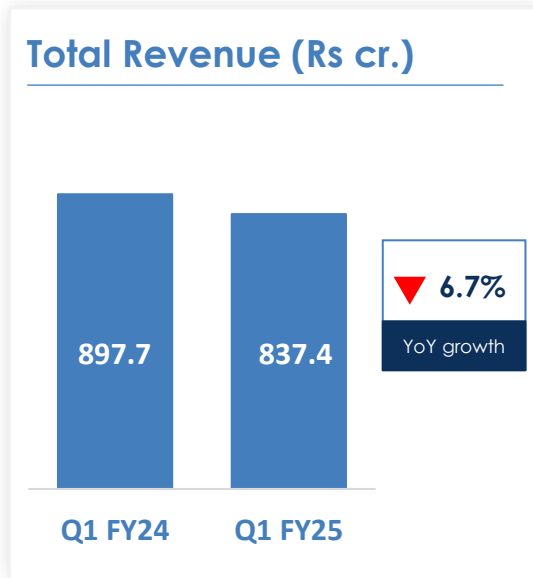

› Total Revenue decreased by 6.7% from Rs. 897.7 Cr in Q1 FY24 to Rs. 837.4 Cr in Q1 FY25

› EBITDA decreased by 1.4% from Rs. 80.9 Cr in Q1 FY24 to Rs. 79.8 Cr in Q1 FY25

— Improved margin on account of LMCA divestment. On a like-for-like basis, adverse product mix and lower absorption of fixed cost impacted profitability.

› PAT increased by 61.2% from Rs.12.1 Cr in Q1 FY24 to Rs. 19.5 Cr in Q1 FY25

— Exceptional income of Rs. 0.2 Cr in Q1 FY'25 (Rs. 19.9 Cr in Q1 FY'24 towards warranty provision and VRS).

# **Rane (Madras) Limited**

## **Q1 FY25 Financial & Operational Performance**

## Business Drivers

- › Demand environment in India remained challenging due to decline in the served models in farm tractor segment and lower sales of passenger cars
- › Exports was impacted due to drop in ATV segment and end of production of steering supplies to Tier-1 customer. We expect exports sales to improve in H2 FY25.

## Operational Highlights

- › Great Place to Work (GPTW) certified for the seventh consecutive year
- › Varanavasi plant received GreenCo – Gold Rating from CII
- › Won “Quality performance” award from Ashok Leyland and Dana India for achieving Zero PPM
- › Won the best prize for using Advanced Quality control tools in the 36th Edition of CII National level QC Competition

## Business Split (Q1 FY25) – RML India

### BY MARKET (%)

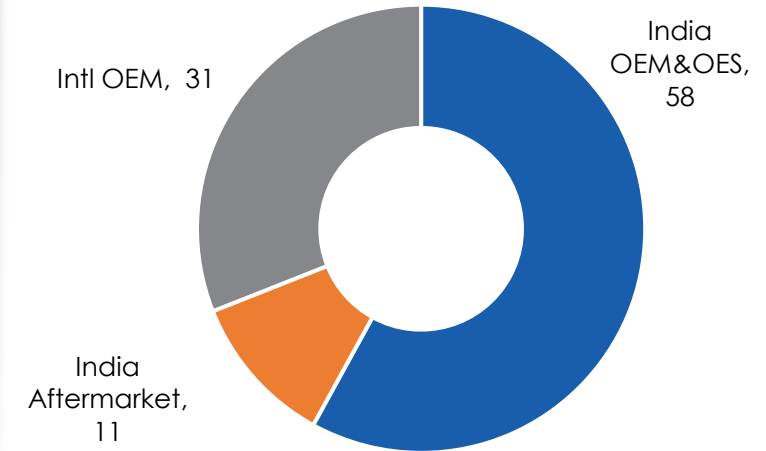

### BY VEHICLE SEGMENT (%)

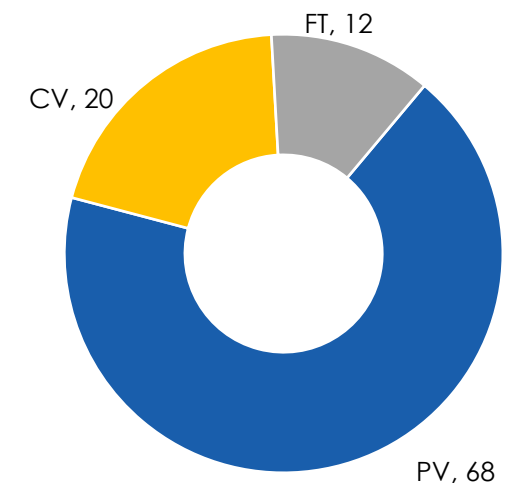

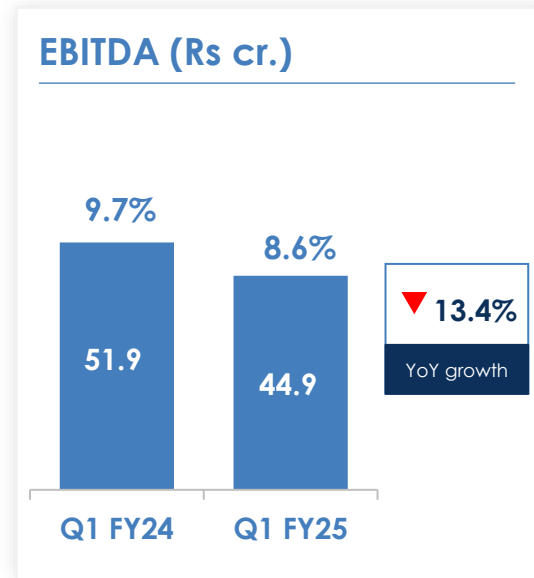
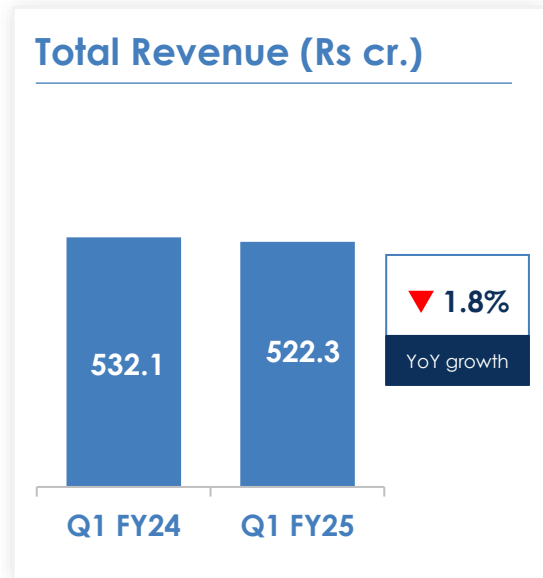

› **Total Revenue decreased by 1.8% from Rs. 532.1 Cr in Q1 FY24 to Rs. 522.3 Cr in Q1 FY25**

- Sales to Domestic OE customers had muted growth of 1%. Growth in PV segment was offset by drop in FT volume
- Sales to Indian Aftermarket customers grew by 1%.
- Export Sales declined 5%. Lower off-take of steering products particularly in the ATV segment.

› **EBITDA decreased by 13.4% from Rs. 51.9 Cr in Q1 FY24 to Rs. 44.9 Cr in Q1 FY25**

- EBITDA margin declined by 114 bps on account of inflationary pressure on select materials and freight.

› **PAT increased by 154.2% from Rs. 3.0 Cr in Q1 FY24 to Rs. 7.6 Cr in Q1 FY25**

- Exceptional expenses of Rs. 0.1Cr in Q1 FY'25 (Rs.18.8 Cr in Q1 FY'24 - towards provision for one time warranty related costs & VRS)

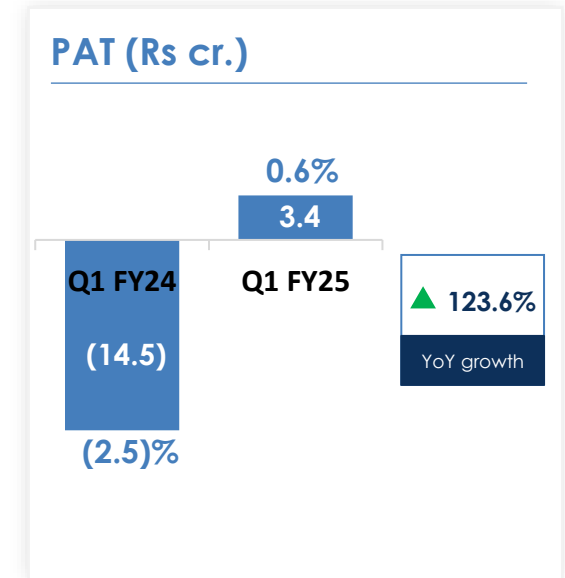
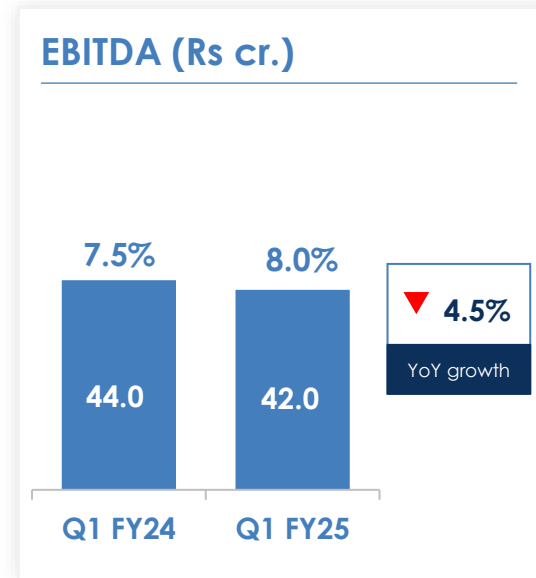
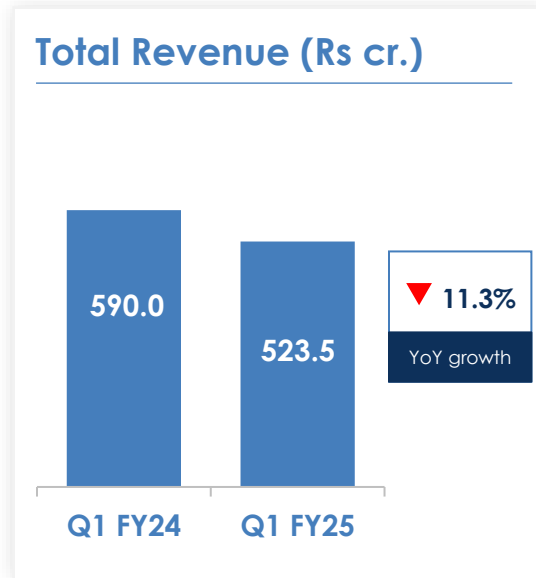

- › Total Revenue decreased by 11.3% from Rs. 590.0 Cr in Q1 FY24 to Rs. 523.5 Cr in Q1 FY25
- › EBITDA decreased by 4.5% from Rs. 44 Cr in Q1 FY24 to Rs. 42 Cr in Q1 FY25
- › PAT increased from loss of Rs. 14.5 Cr in Q1 FY24 to profit of Rs. 3.4 Cr in Q1 FY25

— Exceptional expenses of Rs. 0.1 Cr in Q1 FY'25 (Rs. 18.8 Cr in Q1 FY'24 - towards provision for one time warranty related costs and VRS)



# **Rane Engine Valve Limited**

**Q1 FY25 Financial & Operational Performance**



## Business Drivers

- › 41% of revenue generated from EV insulated segment.

## Operational Highlights

- › Received the Long-term Association Award for over three decades of collaboration with Escorts Kubota Limited.
- › Great Place to Work (GPTW) certified for the third consecutive year

### Business Split (Q1 FY25)

#### BY MARKET (%)

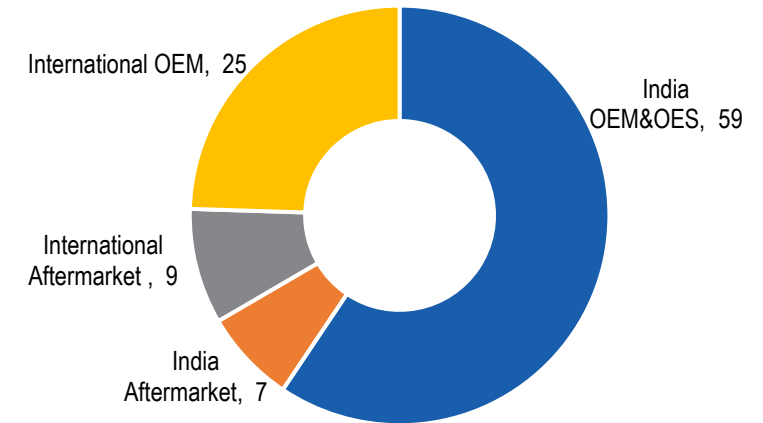

#### BY VEHICLE SEGMENT (%)

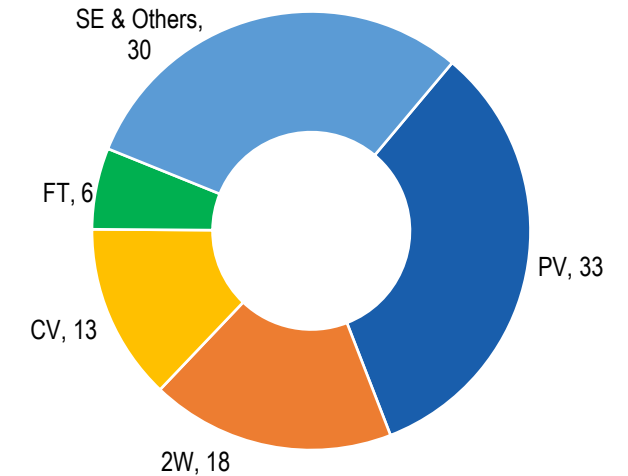



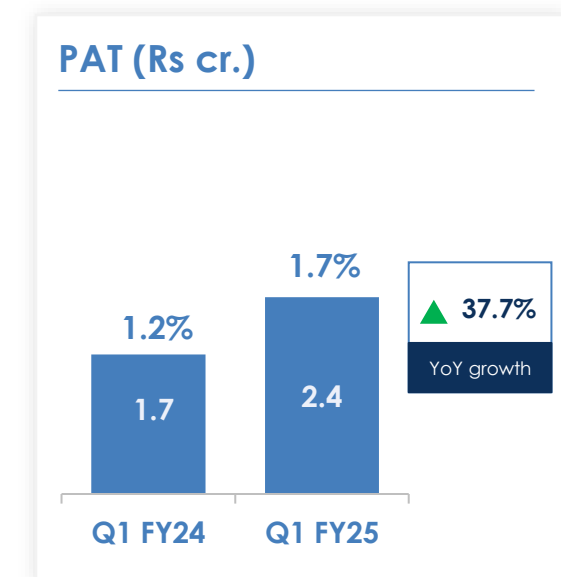
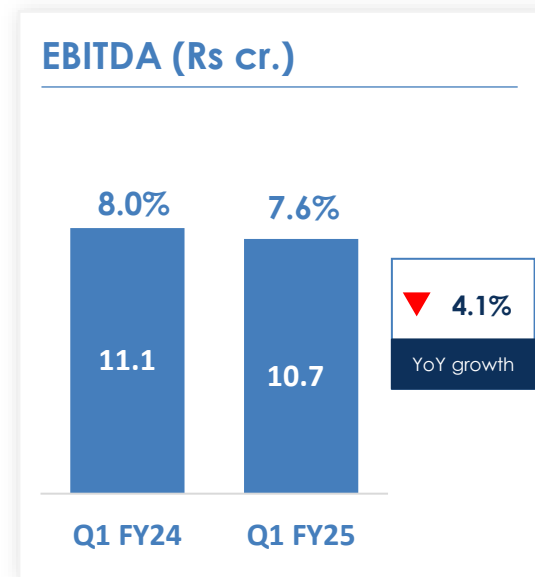
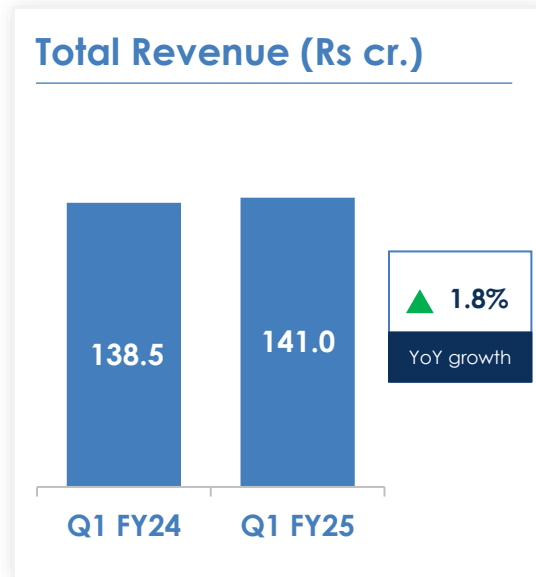

› **Total Revenue increased by 1.8 % from Rs. 138.5 Cr in Q1 FY24 to Rs. 141.0 Cr in Q1 FY25**

- Sales to India OE customers grew by 6% supported by strong off-take from Passenger Vehicle customers.
- Export Sales declined by 13%. Demand from export customers was muted.
- Sales to Indian Aftermarket customers grew by 6%.

› **EBITDA decreased by 4.1% from Rs. 11.1 Cr in Q1 FY24 to Rs. 10.7 Cr in Q1 FY25**

- Adverse product mix resulted in 46 bps drop in EBITDA margin.

**PAT increased from Rs. 1.7 Cr in Q1 FY24 to Rs. 2.4 Cr in Q1 FY25**

- Exceptional income of Rs. 0.3 Cr in Q1 FY'25 (Exceptional Expense Rs. 1.1 Cr in Q1 FY'24 towards customer claim).



# **Rane Brake Lining Limited**

## **Q1 FY25 Financial & Operational Performance**



## Business Drivers

- › Strong growth in Passenger Vehicle segment and increased penetration in two wheeler segment
- › Sluggish demand in Aftermarket segment due to liquidity issues and higher inventory with dealers
- › Continued traction in International Aftermarket segment

## Operational Highlights

- › Great Place to Work (GPTW) certified for the eighth consecutive year
- › RBL - Trichy won Excellence Award, Par Excellence Award and Distinguished award in 10th National conclave on 5S organized by QCFI

**Business Split (Q1 FY25)**  
**BY MARKET (%)**

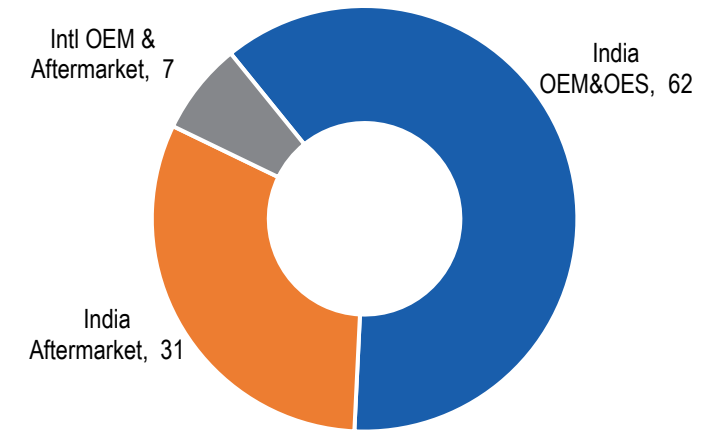

**BY VEHICLE SEGMENT (%)**

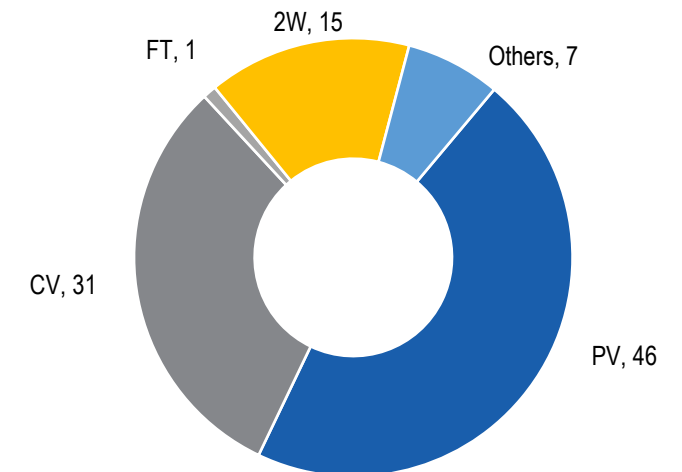

## Total Revenue (Rs cr.)

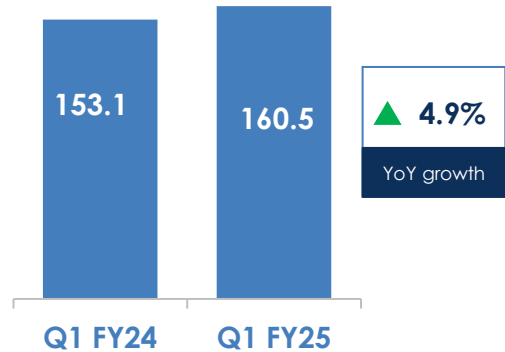

## EBITDA (Rs cr.)

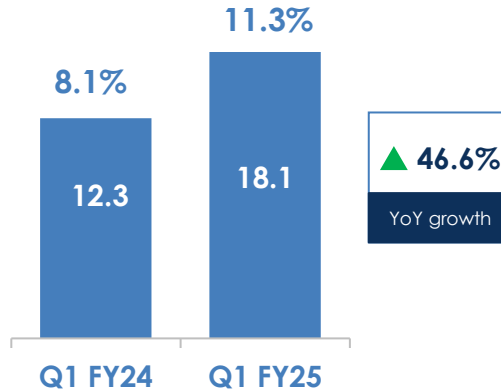

## PAT (Rs cr.)

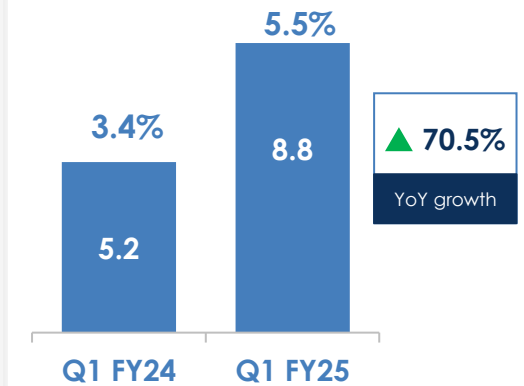

### › Total Revenue increased by 4.9% from Rs. 153.1 Cr in Q1 FY24 to Rs. 160.5 Cr in Q1 FY25

- Sales to OE customer grew 8%. Strong growth driven by demand from two wheelers and passenger vehicle segments.
- Sales to Aftermarket customers declined 4%. Liquidity issues in the market coupled with high inventory with distributors led to lower sales.
- Export sales grew 29%. Executed orders from US and appointed dealers in new regions such as Kenya and Uganda.

### EBITDA increased by 46.6% from Rs. 12.3 Cr in Q1 FY24 to Rs. 18.1 Cr in Q1 FY25

- EBITDA margin improvement mainly driven by operational improvement activities and forex. This was partially offset by unfavourable mix.

### › PAT increased by 70.5% from Rs. 5.2 Cr in Q1 FY24 to Rs. 8.8 Cr in Q1 FY25



# **ZF Rane Automotive India Private Limited**

## **Q1 FY25 Financial & Operational Performance**

## Business Drivers

- › Muted growth in the CV segment impacted the growth of steering division
- › Exports of Occupant Safety products was impacted due to end of program of a part
- › Sales of Steering Wheels included in OSD

## Operational Highlights

- › All the manufacturing facilities of SGD received “Quality performance Award 2024” from Ashok Leyland for achieving line PPM Targets for the Year 2023-24.
- › Great Place to Work (GPTW) certified for the third consecutive year.

### Business Split (Q1 FY25)

#### BY MARKET (%)

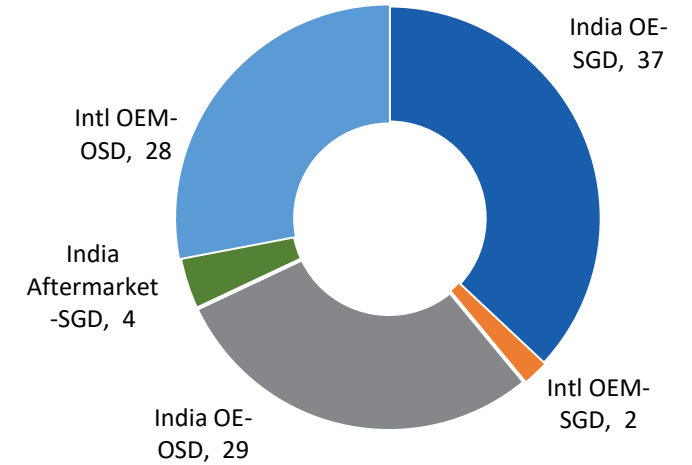

#### BY VEHICLE SEGMENT (%)

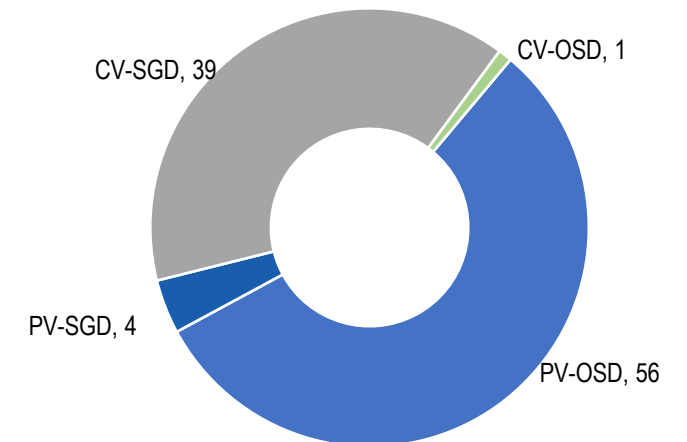

## Total Revenue (Rs cr.)

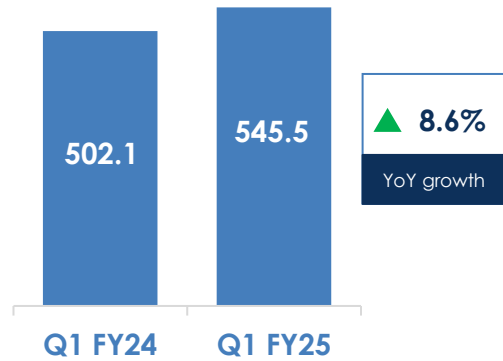

## EBITDA (Rs cr.)

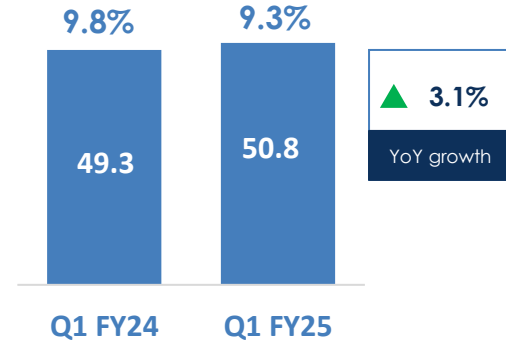

## PAT (Rs cr.)

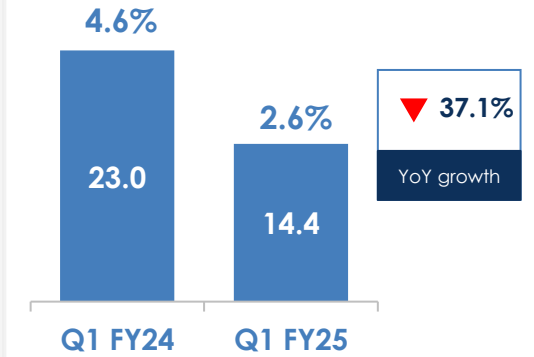

› **Total Revenue increased by 8.6% from Rs. 502.1 Cr in Q1 FY24 to Rs. 545.5 Cr in Q1 FY25**

- Revenue from steering gear products decreased 1% due to lower off-take in commercial vehicle segment
- Revenue from occupant safety systems grew 19% on account of TSSW acquisition. On organic basis it grew by 6%

› **EBITDA increased by 3.1% from Rs. 49.3 Cr in Q1 FY24 to Rs. 50.8 Cr in Q1 FY25**

- EBITDA margin declined by 50 bps due to adverse product mix.

› **PAT decreased by 37.1% from Rs. 23.0 Cr in Q1 FY24 to Rs. 14.44 Cr in Q1 FY25**

- PAT margin declined due to higher depreciation and finance cost towards investment for on-going projects.

# **Rane NSK Steering Systems Private Limited**

## **Q1FY25 Financial & Operational Performance**



## Business Drivers

- › Favorable growth in served models with the key customer

## Operational Highlights

- › Great Place to work (GPTW) certified for the second consecutive year
- › Company continued to win various accolades –
  - Received the Overall performance award from MSIL.
  - Received Localization of design & development capability award from MSIL
  - Received the quality performance award and zero PPM appreciation from Ashok Leyland.
  - Received award for Quick resolution of market feedback from MSIL.

## Business Split (Q1 FY25)

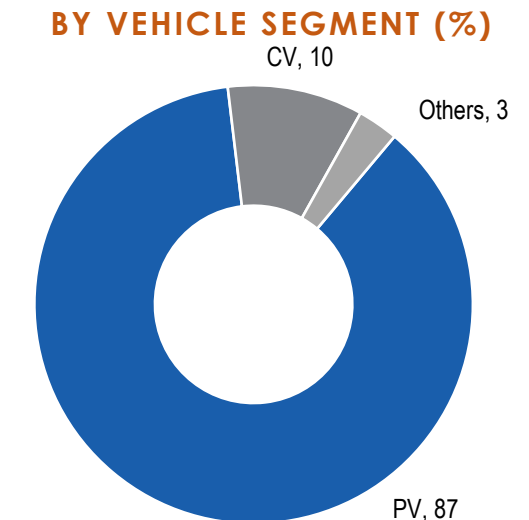
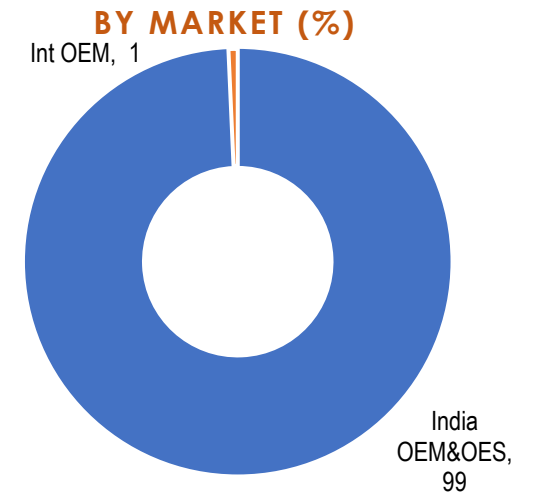

## Total Revenue (Rs cr.)



## EBITDA (Rs cr.)

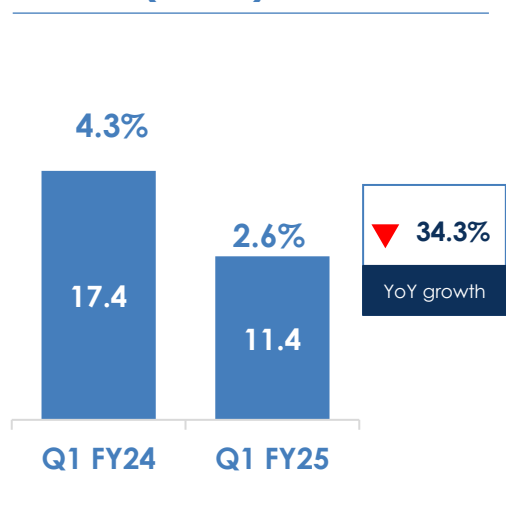

## PAT (Rs cr.)

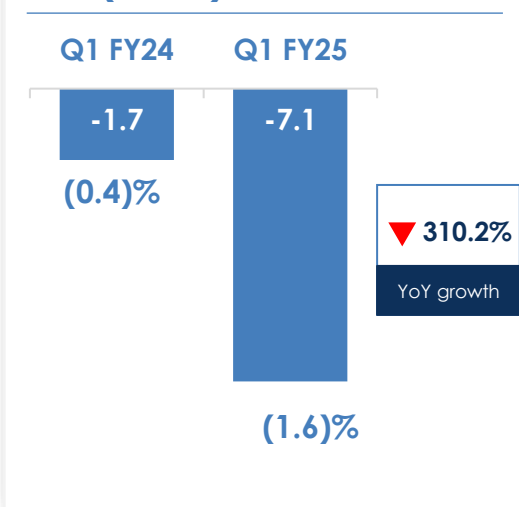

- › **Total Revenue increased by 9.4% from Rs. 400.3 Cr in Q1 FY24 to Rs. 438.0 Cr in Q1 FY25**
  - Lower offtake of Manual Steering Column from CV customers
  - Electric Power Steering benefitted on account of strong growth on served models
- › **EBITDA decreased by 34.3% from Rs. 17.4 Cr in Q1 FY24 to Rs. 11.4 Cr in Q1 FY25**
  - Higher material cost and adverse product mix impacted the profitability
- › **PAT Loss increased from Rs. 1.7 Cr in Q1 FY24 to Rs. 7.1 Cr in Q1 FY25**



# Rane Group

## About Us



Founded in 1929 and headquartered in Chennai, Rane Group is one of the preferred OE manufacturer and supplier for global auto majors



The Group serves a variety of industry segments: Passenger Vehicles, Commercial Vehicles, Farm Tractors, Two-wheelers, Three-wheelers, Railways and Stationary Engines



Manufactures Steering and Suspension systems, Friction materials, Valve train components, Occupant safety systems and Light metal casting products.

REVENUE BY MARKET (%)

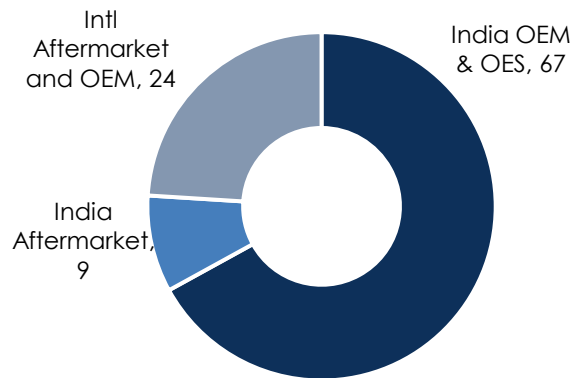

REVENUE BY VEHICLE SEGMENT (%)

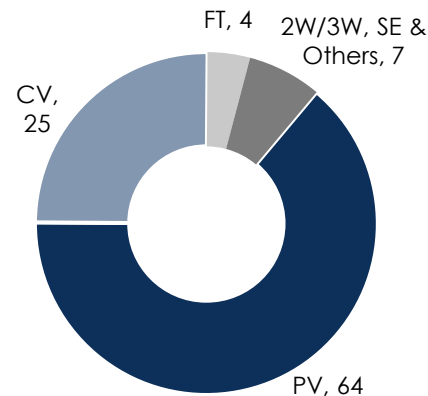

## GROUP SALES OF INR 7,199 CR (~USD 870 MN)-FY'24

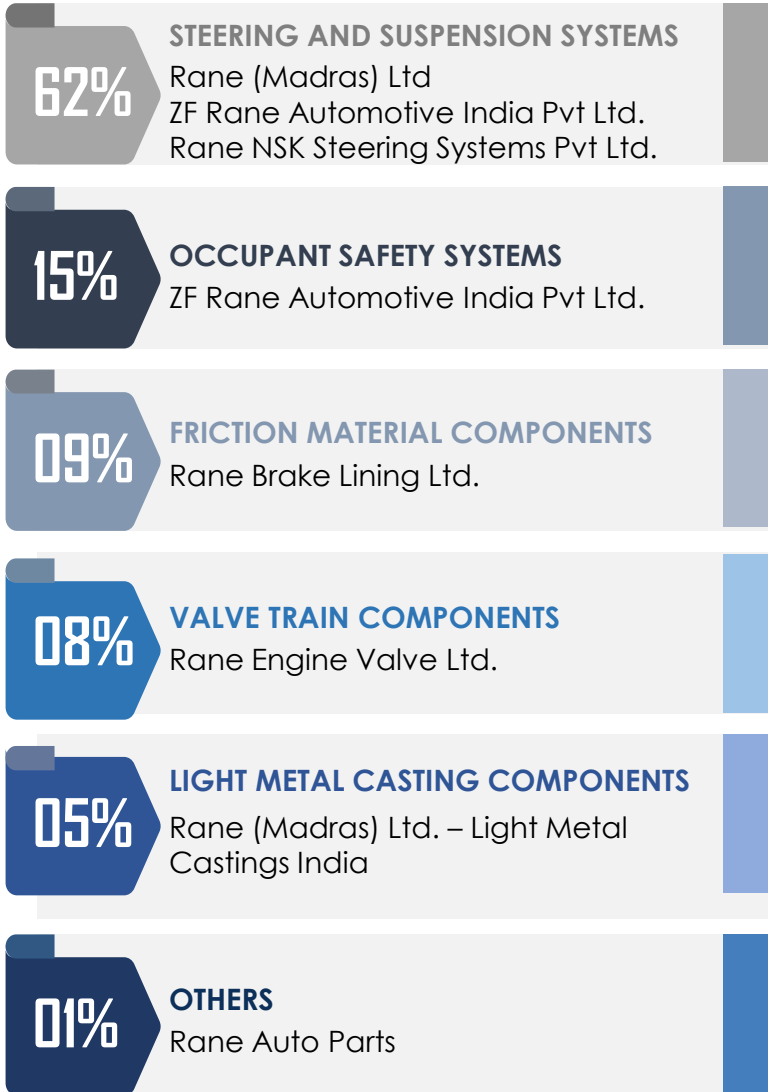

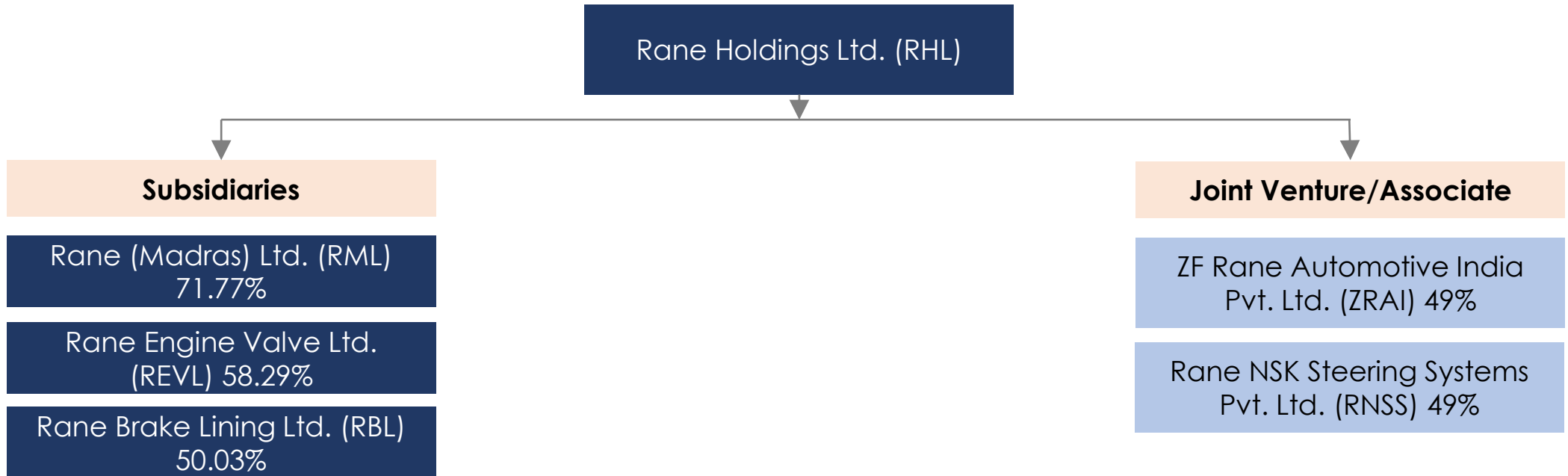

Listed

Share holding as on 30 June 2024

- Market leader in steering gear and steering linkage products in India. We have started catering to hydraulic products such as HSU and steering cylinders.
- Best in class manufacturing facilities at Chennai, Mysore, Puducherry and Pant Nagar.
- End to end testing facilities in house to validate the products' functional, endurance and environmental parameters.

## PRODUCTS

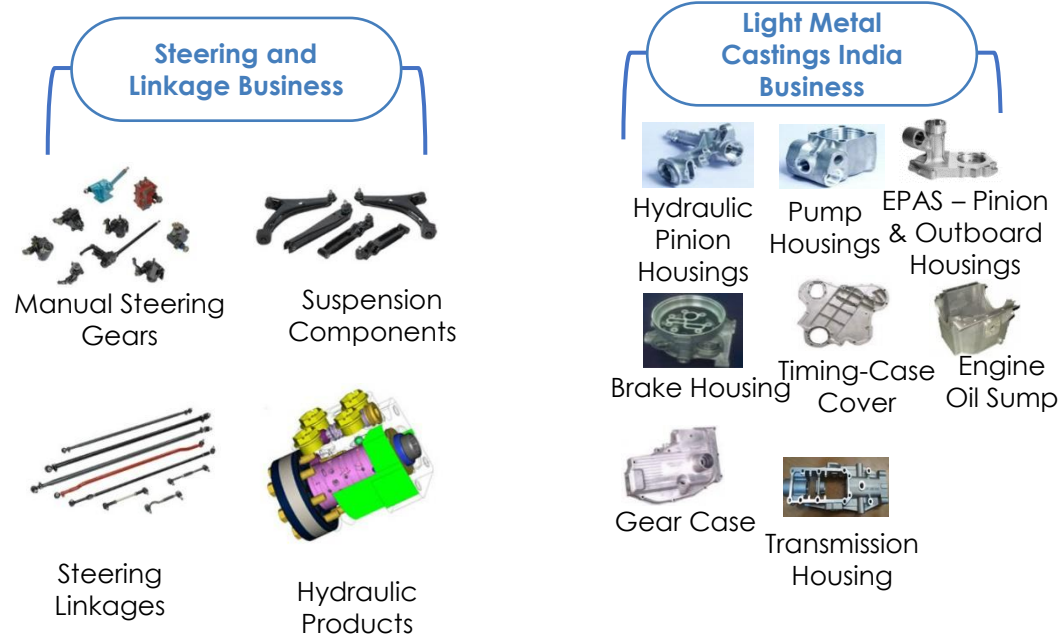

## MANUFACTURING PLANT

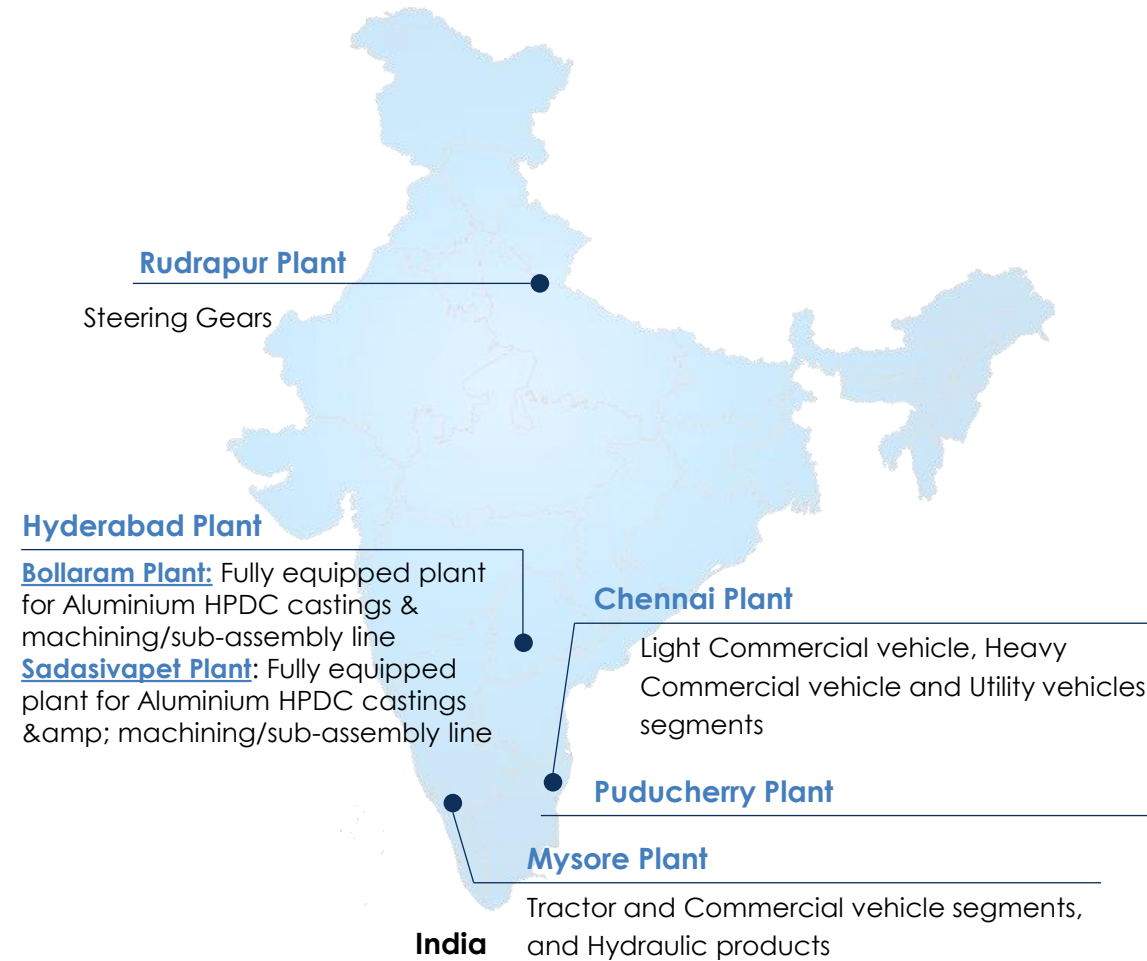

- Incepted In 1959, REVL manufactures valves and valve train components for various engine applications
- Non Automotive applications such as power generation, marine, defence, locomotive, etc.
- Comprehensive test laboratory for material characterisation, simulated test rigs and engine dynamometer test facility.

## PRODUCTS

Engine Valves



Valve Guides



Mechanical Tappets



## MANUFACTURING PLANT



### Hyderabad Plants (2)

Small Valves for 2W and PC  
Medium Valves for PC, Industrial and CV

### Tumakuru Plant

Medium Valves for CV and Farm Tractors  
Large & Extra Large Valves for Industrial, Power Generation and Marine Applications

### Chennai Plant

Small Valves for 2W and PC  
Medium Valves for Tractors and PC Guides, Tappets

### Trichy Plant

Small & medium Valves for 2W, PC and CV

- Established in 1964, RBL is a leader in Friction Products across OEM segments and supplies products to over 15 countries
- Technical collaboration with Nisshinbo Brakes Inc.
- Library of widely tested and approved formulations to suit diverse market / customer requirements.
- State-of-the-art R&D center equipped with full scale inertia dynamometer, static mu-measurement and NVH study rig.

## PRODUCTS

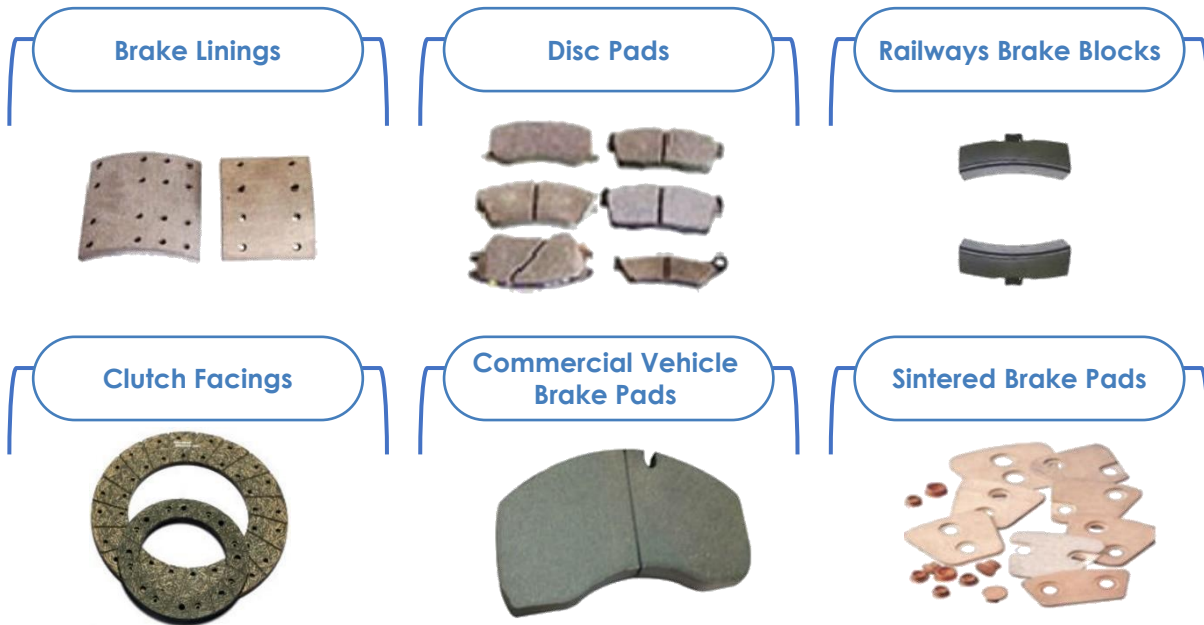

## MANUFACTURING PLANT

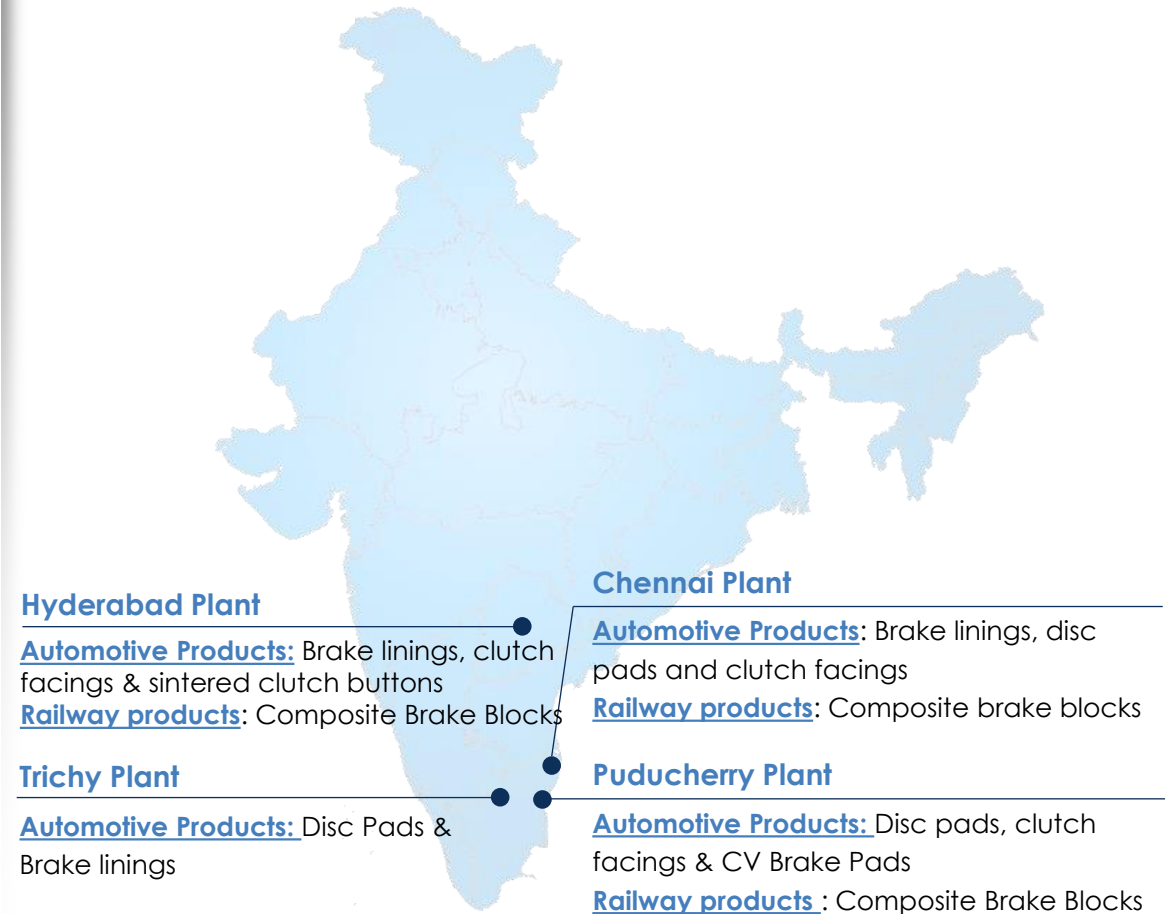



Joint venture partnership with ZF Group, Germany.

## Steering Gear Division

- Design, Development and Application capability for complete Hydraulic Power Steering system for all vehicles.
- Advanced design tools for 3D modeling, simulation, FE analysis and CFD.
- State-of-the-art testing facilities for strength, environment, noise, fatigue and durability tests to meet global standards

## Occupant Safety Division

- Product range includes different types of airbags, seatbelt technologies and steering wheels. Retractor and Anchor pretensioners, Emergency Locking Retractor (ELR), Load Limiters, Child Restraint Seat Belt, Driver Airbag, Passenger Airbag, Side Airbag and Curtain Airbags.
- Extensive testing facilities for seat belts include Extraction and Retraction Force Testing Machine, Retractor Durability Tester, Hot & Cold Chamber, Salt spray chamber, ELR functional tester.
- Equipped with Test lab to carry out testing as per National (IS/AIS), International (ECE/EEC/GS/VSCC), customer specifications and COP testing

## PRODUCTS

### Steering Gear Division



### Occupant Safety Division



## MANUFACTURING PLANT

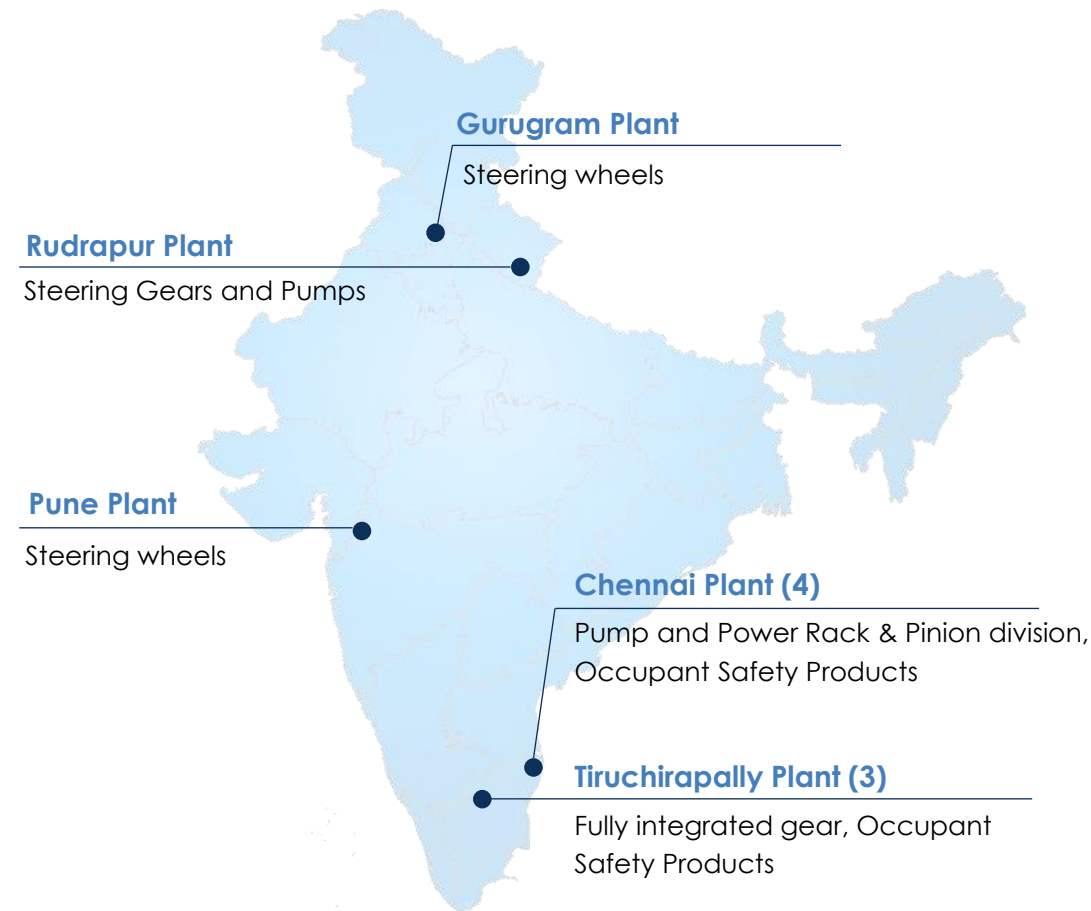

- Joint venture partnership with NSK, Japan.
- State-of-art R&D test lab for validation of steering columns.
- Manufacturing facilities across four locations in Chennai, Bawal, Rudrapur & Ahmedabad.
- Design & Development capability for solid & energy absorbing columns. Development and application capability for EPS.
- Driver comfort, Passenger safety, Ergonomics and NVH requirements are kept as targets while designing steering system.
- Comprehensive test laboratory for extensive research about column performance characteristic validation, strength and durability validation and NVH requirements.
- Design team includes CAD & CAM application experts and software analysts.

## ▶▶▶ PRODUCTS



## MANUFACTURING PLANT

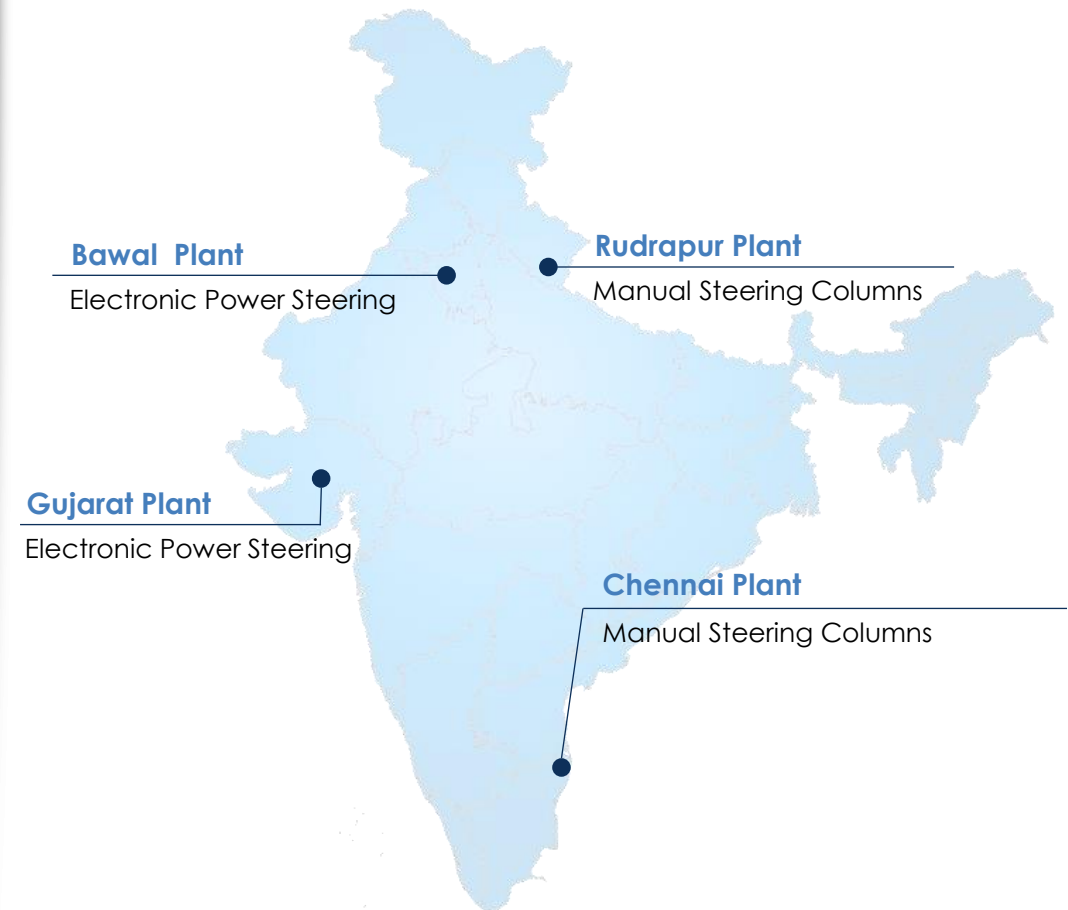

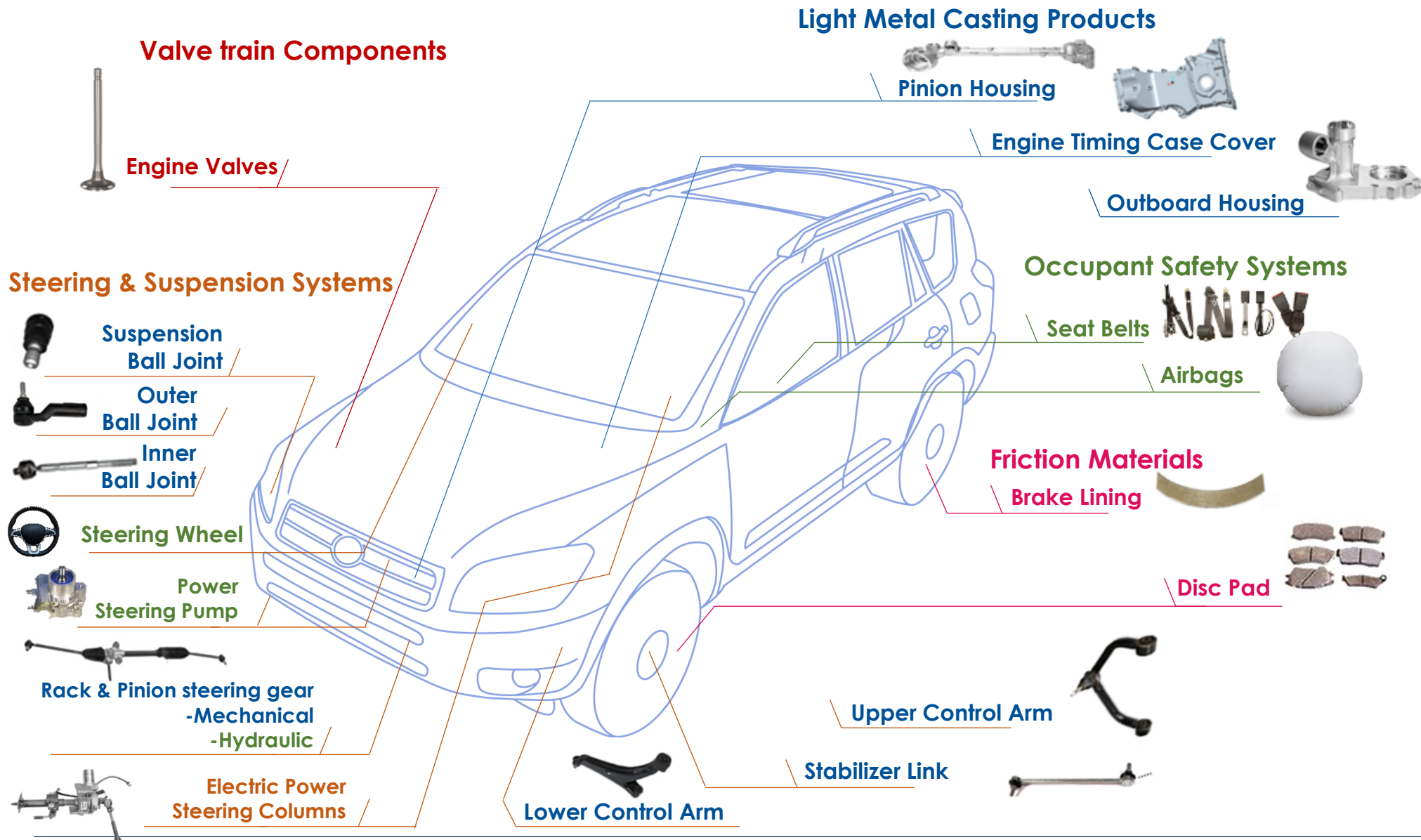

## Rane (Madras)

- › Manual Steering Gears
- › Steering Linkages
- › Suspension Components
- › Light Metal Casting Products

## Rane Engine Valve

- › Engine Valves

## Rane Brake Lining

- › Brake Linings
- › Disc Pads

## Rane NSK Steering Systems

- › Electric Power Steering Systems

## ZF Rane Automotive India Pvt Ltd.

- › Hydraulic Power Steering systems
- › Steering Wheel
- › Seat Belts
- › Airbags

## Steering & Suspension Systems



## Light Metal Casting Products

Hydraulic Pump Housing



## Occupant Safety Systems

Seat Belts



## Friction Materials

Brake Lining



Disc Pad



## Valve train Components

Valve Guides



Engine Valves



### Rane (Madras)

- › Manual Steering Gears
- › Steering Linkages
- › Hydraulic Cylinders
- › Light Metal Casting Products

### Rane Engine Valve

- › Engine Valves
- › Valve Guides

### Rane Brake Lining

- › Brake Linings
- › Brake Pads

### Rane NSK Steering Systems

- › Manual Steering Column

### ZF Rane Automotive India Pvt Ltd.

- › Hydraulic Power Steering Systems
- › Steering Wheel
- › Seat Belts



## Steering & Suspension Systems



Manual Steering /  
Column  
Manual RCB  
Steering Gear



Hydrostatic  
Steering Unit



Power Steering  
Gear



Drag Link Assembly



Tie Rod Assembly

Hydraulic  
Cylinder



## Friction Materials

Clutch Facings



Brake Lining

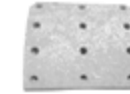

## Light Metal Casting Products

Timing Case Covers



Seat Belts



## Valve train components

Valve Guides



Engine Valves



### Rane (Madras)

- › Manual Steering Gears
- › Steering Linkages
- › Hydraulic Cylinders
- › Hydrostatic Steering Unit
- › Light Metal Casting Products

### Rane Engine Valve

- › Engine Valves
- › Valve Guides

### Rane Brake Lining

- › Brake Linings
- › Clutch Facings

### Rane NSK Steering Systems

- › Manual Steering Column

### ZF Rane Automotive India Pvt Ltd.

- › Hydraulic Power Steering systems
- › Seat Belts

## Friction Materials

Disc pad

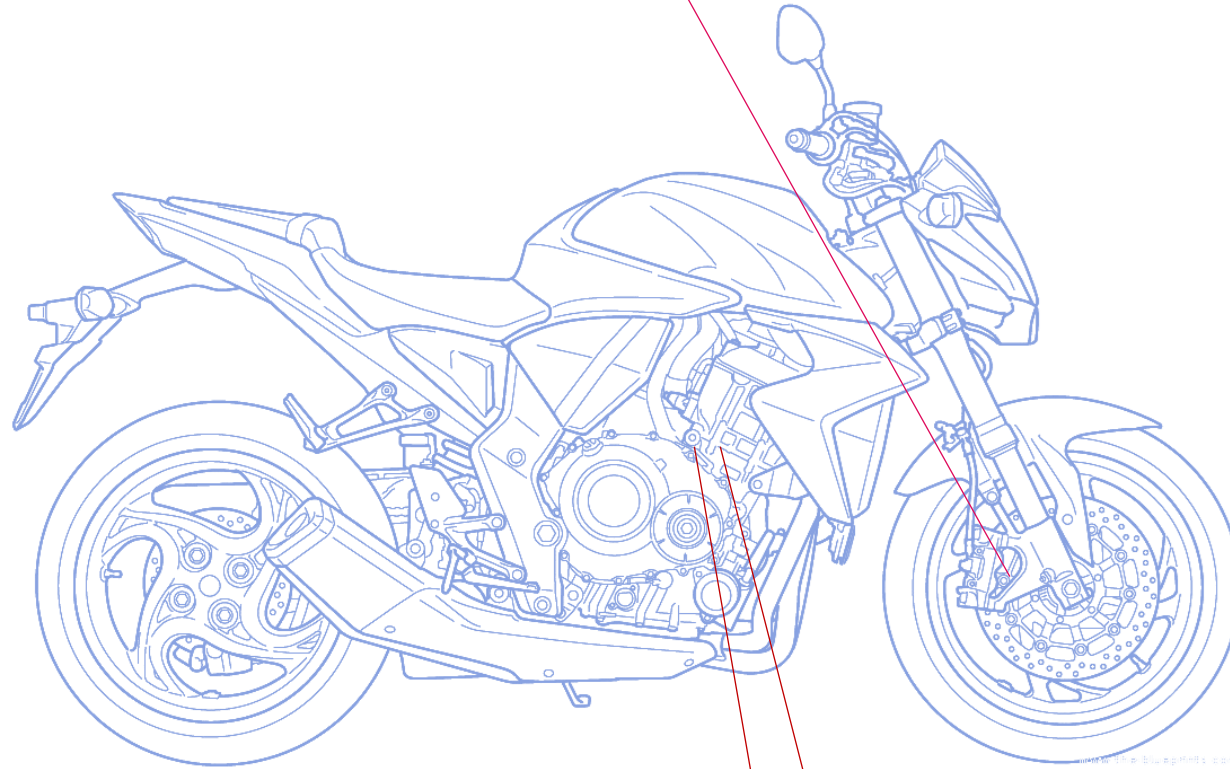

### Rane Brake Lining

- › Disc Pads

### Rane Engine Valve

- › Engine Valves
- › Valve Guides

## Valve train Components

Valve Guides



Engine Valves



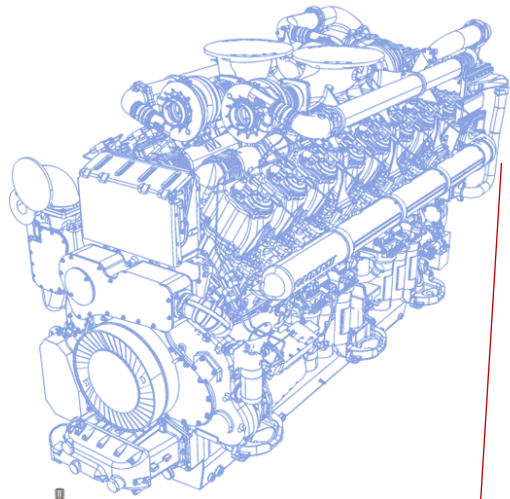

**Engine Valves / Valve Guides**

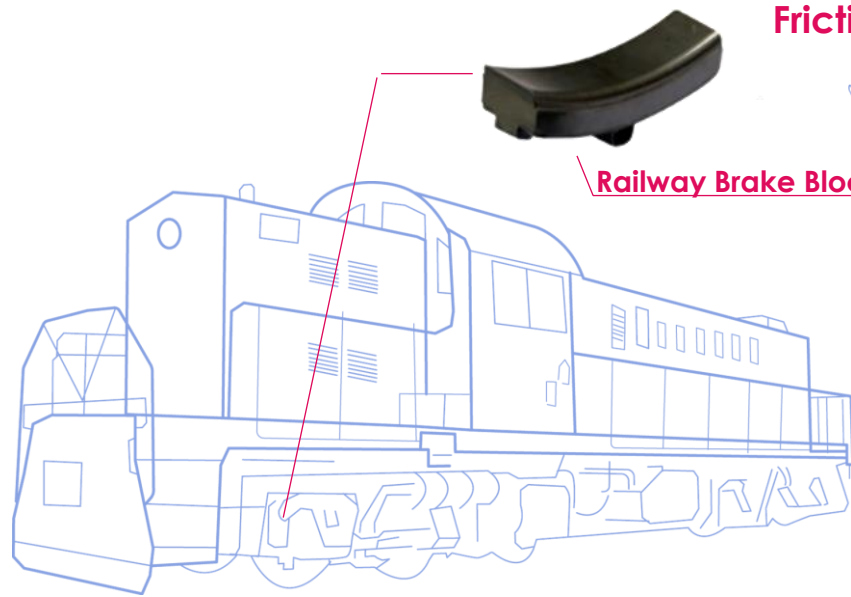
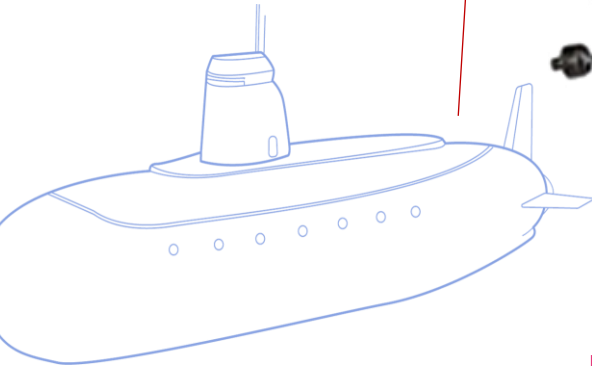

**Railway Brake Block**

**Friction Materials**



**Sintered Brake Pads**

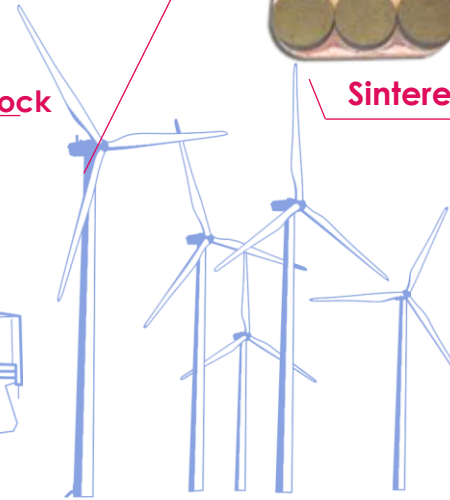

**Suspension Ball Joint**

**Outer Ball Joint**

**Inner Ball Joint**

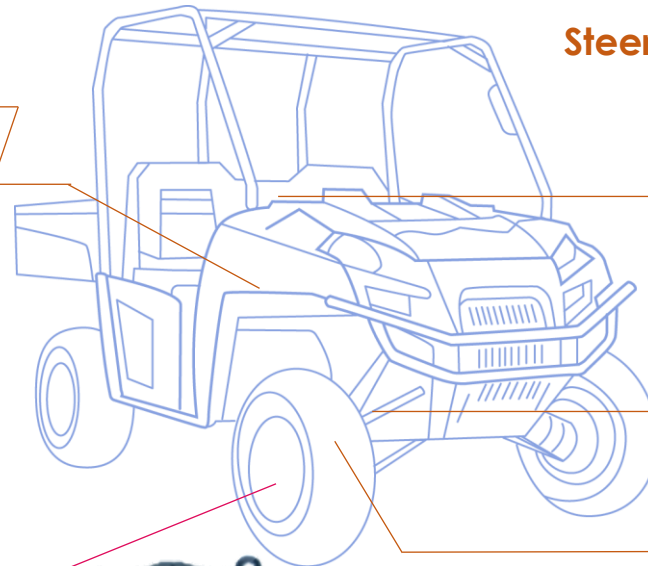

**Steering & Suspension Systems**



**Steering Shafts**



**Rack & Pinion steering gear -Mechanical**



**Stabilizer link**



**Friction Materials / Disc pad**

**Rane (Madras)**

- › Manual Steering Gears
- › Steering Linkages
- › Light Metal Casting Products

**Rane Engine Valve**

- › Engine Valves
- › Valve Guides

**Rane Brake Lining**

- › Sintered Brake Pads
- › Railway Brake Block

**Rane NSK Steering Systems**

- › Steering Shafts

An illustrious journey of over 80 years from distributor of automobile and auto components to winner of Deming prize for manufacturing

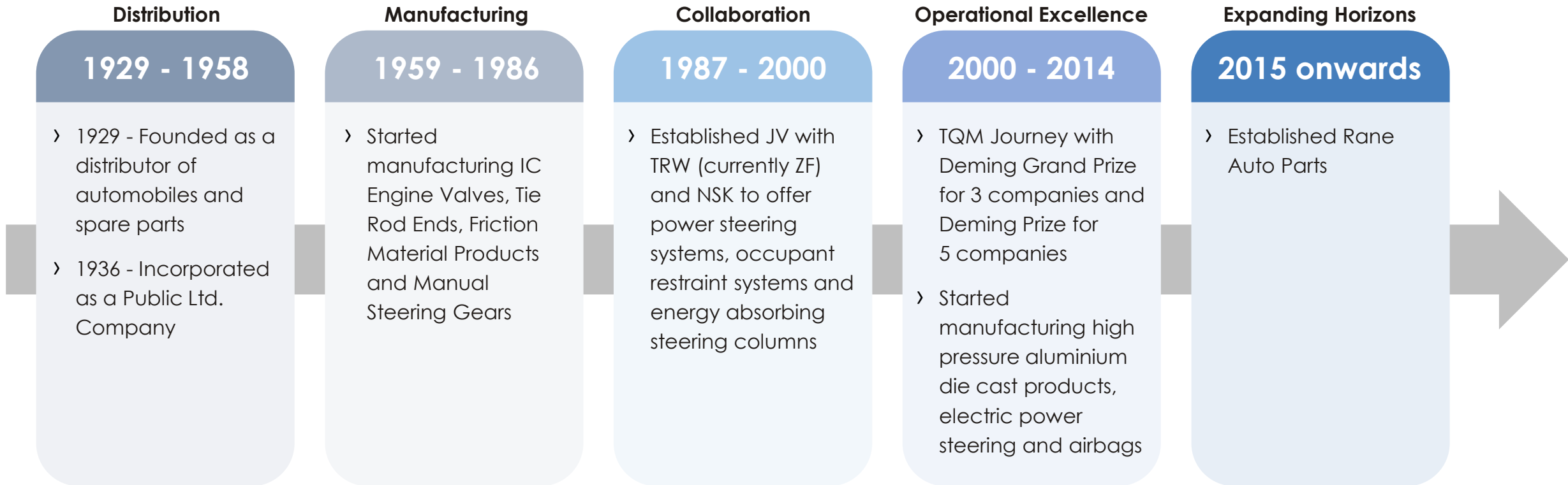





**30+** Serve customers in 30+ countries

**29** Manufacturing locations across India

Customer Locations   Manufacturing Locations   Sales Offices

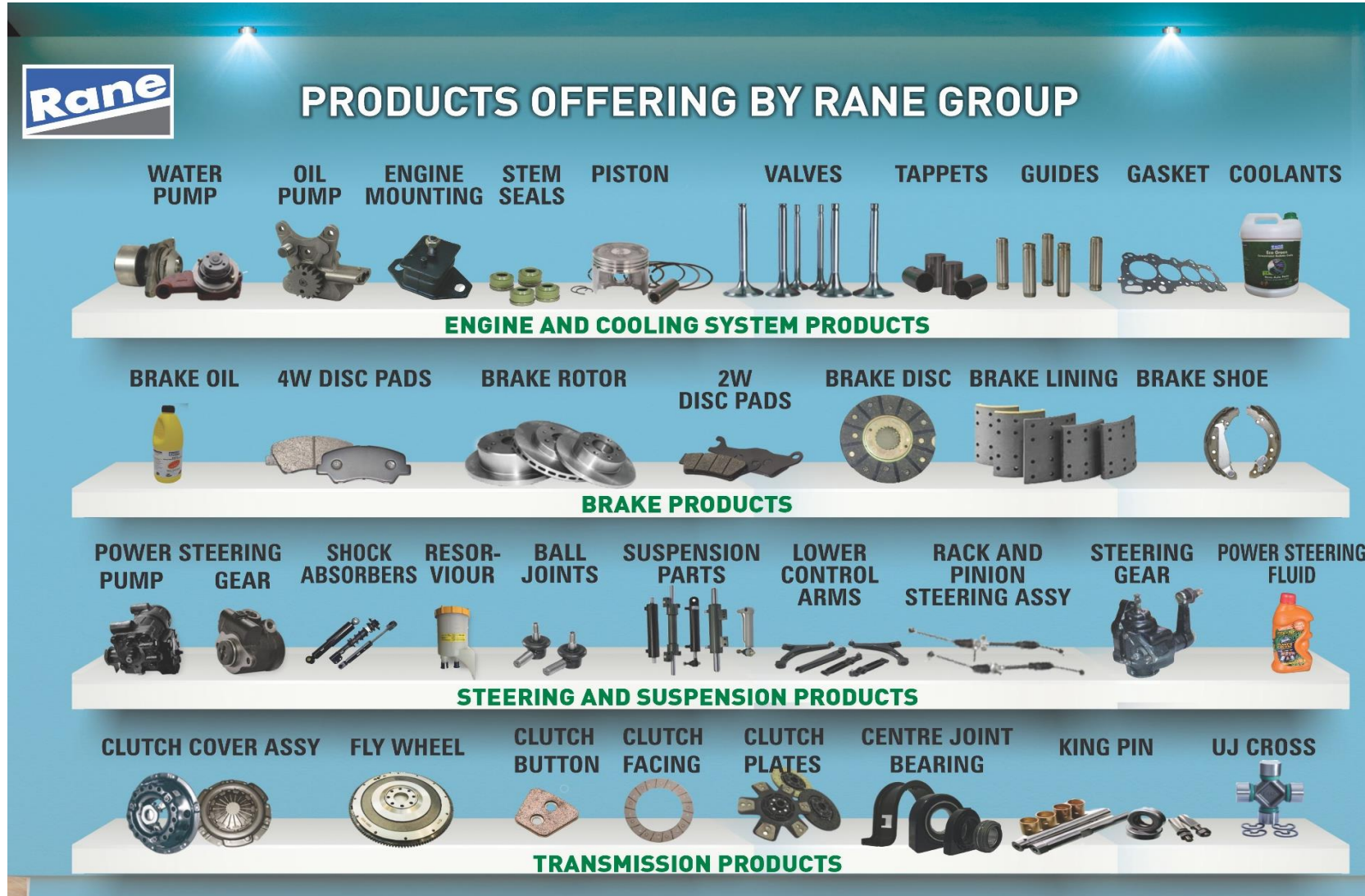

Increasing Group's brand presence in aftermarket through enhanced product portfolio and wider market reach

## Strong CAE Capabilities – Design, Analysis & Simulation Software

**230** R&D Engineers

**42** Functional Test Rigs

**26** Strength Test Rigs

**62** Durability Test Rigs

**33** Environmental Test Rigs

**10** Noise Test Rigs



Hydraulic Power Steering Systems and Occupant Safety Systems



Energy Absorbing Steering Columns and Electric Power Steering



Brake Linings, Discs Pads and Clutch Facings



We create and deliver value to our customers

Passenger Vehicle

Commercial Vehicle

Farm Tractor

Two/Three-Wheeler

Other Applications

INDIA



INTERNATIONAL



**'Customer at the core' remains our priority on the goal to sustainable growth and profitability**



## Rane Group

Customer	Award Category
Maruti Suzuki	Supplier Collaboration Initiatives
Mahindra & Mahindra	Business Partner of the year – Automotive Division
Ki Mobility Solutions	Partnership of Excellence



## Rane (Madras)

Customer	Award Category
Volvo Eicher	New Product Development Award
Nexteer	Perfect Quality Award
TAFE	Best Supplier & Benchmark Award
Maruti Suzuki	Superior Performance Award, Special Support
SML Isuzu	New Product Development Award
Tata Motors	Award for Exceptional Support, Best Supplier – Demand Fulfillment
Polaris	Supplier of Excellence
Daimler India	Reliable Partner & Achieving 100% in delivery



## Rane Engine Valve

Customer	Award Category
Groupe Renault	Quality & Customer Satisfaction
John Deere India	Quality Appreciation Award
Volvo Eicher	Quality & Delivery excellence
Renault Nissan	Quality & Customer Satisfaction
Hyundai	Appreciation Award
Cummins India	Superior Quality Award



## ZF Rane

Customer	Award Category
Ashok Leyland	Best Performance in Business Alignment-Gold
Isuzu Motors	Most Improved Supplier Award
Tata Motors	Best Supplier Award, Efficiency Award, Best in Class Award
Volvo Eicher	Best Supplier in NPD, Supply Chain, Uptime Excellence
Daimler India	Quality Appreciation Award
Renault Nissan	Best Supplier in Field Quality



## Rane Brake Lining

Customer	Award Category
Brakes India	Best Supplier - Friction
Ashok Leyland	After Market Support Award
Foundation Brake	Business Excellence Award
Endurance	Gold Award for Quality Best Supplier Award, Consistent Vendor Rating Performance Award Capable Supplier Excellence in Technology upgradation



## Rane NSK

Customer	Award Category
Maruti Suzuki	Overall Performance, Localization of design and development capability
Volvo Eicher	Quality Excellence
Daimler India	Best Technology Support

## Rane Values

- › Provide superior products and maintain market leadership
- › Pursue excellence
- › Achieve the highest standard of ethics and integrity

## Rane Approach

- › Build strong connections with customers to understand their challenges
- › Strategic investments to improve quality and productivity
- › TQM way of working
- › Emphasis on 'First-time right' policy

## Rane Credentials

- › Modern manufacturing facilities with IATF 16949 certification
- › State-of-the-art product development and validation capabilities
- › Deming Grand Prize for 3 Rane companies
- › Deming Prize for 5 Rane companies



- › Technology collaboration with top global players



ZF Group, Germany  
Hydraulic Power Steering Systems and Occupant Safety Systems



NSK, Japan  
Energy Absorbing Steering Columns and Electric Power Steering



Nisshinbo Brake Inc., Japan  
Brake Linings, Disc Pads and Clutch Facings

## Value Proposition

- › Superior products driven by execution excellence
- › Trusted partner with shorter development lead times
- › Agile manufacturing process and scalable facilities
- › Provide system-level solutions with deep understanding of customer needs
- › With enhanced R&D capabilities, we provide light-weighting, improved safety and performance

**LONG TERM PARTNER OF CHOICE TO LEADING  
AUTOMOTIVE COMPANIES AND TIER 1 SUPPLIERS**

An exciting workplace founded on the principles of values, fairness and transparency that:



Provides challenging assignments

Encourages learning

Enhances career opportunities



- › **Organisation Development Excellence Award** for the exceptional practices on **Leadership Development** by Transcendence, Tata Institute of Social Sciences (TISS), 2019
- › Recognized by International Federation of Training and Development Organizations in Best HRD practice category, 2018
- › Award for **Talent Management** from the Employer Branding institute, Singapore, 2012 & 2014
- › Significant Achievement in **HR Excellence**, CII, 2012



Certified as a **Great Workplace** by the Great Place to Work institute, 2024



## Systems approach to deliver H&S to our employees

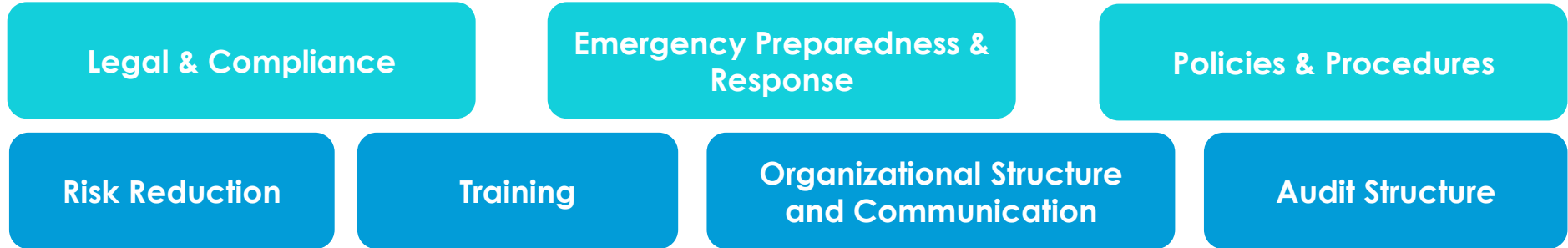

## We create value through sustainable operations and optimal resource utilisation

### Dimensions of Sustainability at Rane Group

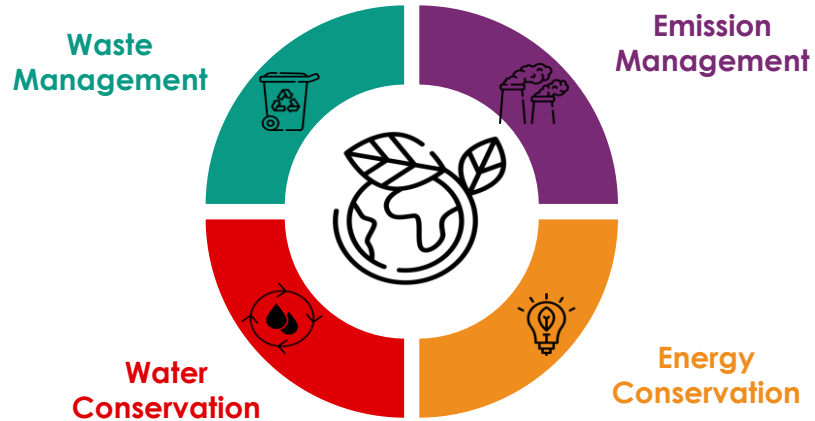

### Recognition in Sustainability Excellence

- Rane Brake Lining - Puducherry won the CII National Award for Excellence in Energy Management
- Rane Brake Lining - Trichy received second prize for Environment Protection and Management by the Government of Tamil Nadu
- Rane NSK Steering Systems – Chennai won the CII National Award for Excellence in Energy Management
- Various facilities are certified by US green building council

### Water Conservation

Water Positive is achieved through Rain Water Harvesting and Water Conservation Techniques



### Energy Conservation



**58.5 lakhs units**  
of power saved on  
annualised basis in FY24



**4,211 MT Tons**  
Reduction of Eq. Co2 emission

### Transitioning to renewable energy



**36% of power demand**  
met by Renewable Energy

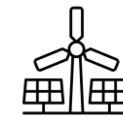

**Reduction of 45,233 MT of Eq. Co2** savings compared to power from traditional sources



- › Rane Foundation (RF) is a **public charitable trust** founded by Rane's promoters in the year 1967
- › RF is the **main arm for Rane's Corporate Social Responsibility (CSR) initiatives** and is exclusively funded by the Rane companies
- › Initiatives are focused on **education, healthcare, environment and community development**

## Rane Polytechnic



### Education

- › Institution Development - Rane Polytechnic, Rane Vidyalaya
- › Vocational Training & Skill Development
- › Awareness programs



### Healthcare

- › Nutrition program
- › Health camps
- › Medical infrastructure & aid



### Environment

- › Plantation drives
- › Infrastructure for sustainability
- › Natural resource preservation



### Community Development

- › Providing amenities & sanitation
- › Improving quality of life
- › Rural infrastructure development program

## Rane Vidyalaya



# Thank You

For further information, please contact:

[investorservices@ranegroup.com](mailto:investorservices@ranegroup.com) or [diwakar.pingle@in.ey.com](mailto:diwakar.pingle@in.ey.com)

## **Rane Corporate Centre**

"Maithri" 132, Cathedral Road,  
Chennai - 600 086, India  
[www.ranegroup.com](http://www.ranegroup.com)

## Glossary of Abbreviations

Abbreviation	Expansion	Abbreviation	Expansion	Abbreviation	Expansion
ACMA	Automotive Component Manufacturers Association	HR	Human Resource	R&D	Research and development
AMP	Advanced Machining Processes	HSU	Hydraulic Steering Unit	R&P	Rack & Pinion
ATV	All-Terrain Vehicle	IC	Internal Combustion	RBL	Rane Brake Lining Limited
bps	Basis point, 100 bps equal to 1%	Intl	International	RCB	Re-Circulating Ball Gear
CAE	Computer-aided engineering	JV	Joint Venture	REVL	Rane Engine Valve Limited
CII	Confederation of Indian Industry	LCV	Light Commercial Vehicles	RHL	Rane Holdings Limited
COP	Conformity of Production	LMCA	Light Metal Casting Inc., America	RML	Rane (Madras) Limited
Cr	Crores	Ltd	Limited	RNSS	Rane NSK Steering Systems Pvt Limited
CFD	Computational fluid dynamics	MSIL	Maruti Suzuki India Limited	SCV	Small Commercial vehicle
CV	Commercial Vehicle	NPD	New Product Development	SE	Station Engine
EBITDA	Earnings Before Interest, Taxes, Depreciation, and Amortization	NVH	Noise, Vibration, and Harshness	SGD	Steering Gear Division
ELR	Emergency Locking Retractor	OE	Original Equipment	SUV	Sports Utility Vehicle
EPAS	Electric Power Assisted Steering	OEM	Original Equipment Manufacturer	TQM	Total Quality Management
EPB	Electronic Parking Brake	OES	Original Equipment Supplier	US	United States
EPS	Earnings per share / Electronic power steering	OSD	Occupancy Safety Division	USD	United States Dollar
EV	Electric vehicle	PAT	Profit After Tax	VRS	Voluntary Retirement Scheme
FE	Finite Element	PC	Passenger Car	YoY	Year-on-Year
FT	Farm Tractors	PPM	Parts per Million	ZRAI	ZF Rane Automotive India Pvt limited
FY	Financial Year	PV	Passenger vehicle	2W/3W/4W	Two Wheeler/Three Wheeler/Four Wheeler
HPDC	High Pressure Die Casting	QCFI	Quality Circle Forum of India		

*This presentation may contain certain forward looking statements concerning Rane's future business prospects and business profitability, which are subject to a number of risks and uncertainties and the actual results could materially differ from those in such forward looking statements. The risks and uncertainties relating to these statements include, but not limited to risks and uncertainties regarding fluctuations in earnings, our ability to manage growth, competition (both domestic and international), economic growth in India and the target countries for exports, ability to attract and retain highly skilled professionals, government policies and action with respect to investments, fiscal deficits, regulations etc., interest and other fiscal costs generally prevailing in the economy. The company does not undertake to make any announcement in case any of these forward looking statement become materially incorrect in future or update any forward looking statements made from time to time by or on behalf of the Company.*