

Registered Office  
"Maithri"  
132, Cathedral Road,  
Chennai 600 086, India.  
CIN: L65993TN2004PLC052856

Tel: 91 44 2811 2472  
URL: [www.ranegroup.com](http://www.ranegroup.com)

## **Rane (Madras) Limited**



**// Online submission //**

RML / SE / 031 / 2022-23

October 31, 2022

<b>BSE Limited</b> <b>Listing Centre</b> Scrip Code: <b>532661</b>	<b>National Stock Exchange of India Ltd.</b> <b>NEAPS</b> Symbol: <b>RML</b>
--	--

Dear Sir / Madam,

**Sub: Earnings Presentation - Un-Audited Financial Results for the half year ended September 30, 2022**

**Ref: Our letter no(s). RML/SE/028/2022-23 dated October 26, 2022 and RML / SE / 029 2022-23 dated October 27, 2022**

This is with reference to the aforementioned letters intimating Earnings Conference Call scheduled on **Monday, October 31, 2022 at 14:00 hours (IST)**, inter alia, to discuss the un-audited financial results for the half year ended September 30, 2022. We enclose herewith copy of the Earnings presentation proposed to be made thereat, to the analyst and investors.

The same is also being made available on the website of the Company, [www.ranegroup.com](http://www.ranegroup.com).

We request you to take the above on record and note the compliance with SEBI (Listing Obligations and Disclosure Requirements) Regulations, 2015 (SEBI LODR).

Thanking you.

Yours faithfully,

For **Rane (Madras) Limited**

S Subha Shree  
**Secretary**

Encl: a/a

# **Rane Group**

---

Earnings Presentation | H1 FY23

# Table of Contents

H1 FY23 Financial & Operational Performance

Rane Group Overview



# Rane Group

## H1FY23 Financial & Operational Performance



To become the Preferred Trusted Supplier of Safety & Critical Auto Components

## Strategic pillars of growth

---

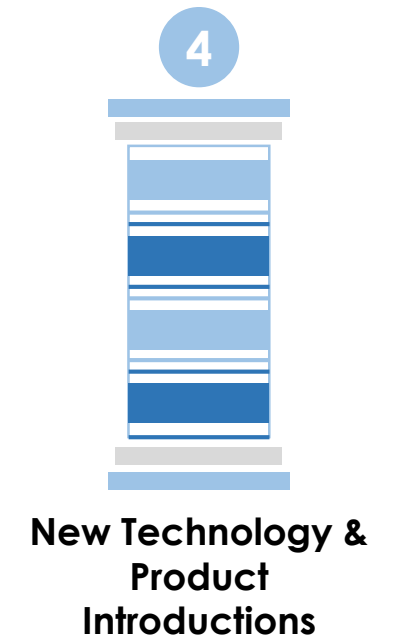
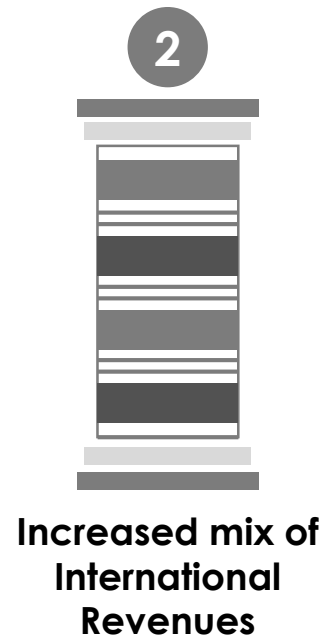

## Business Drivers

- › **93%+ of revenue comes from powertrain agnostic products**
- › **Continued dominance on domestic market across major products**
- › **Increasing export mix for steering & linkages, valve train components and occupant safety products**
- › **Renewed focus on Aftermarket segment leveraging group level synergy**
- › **Continuous introduction of new product and new technology leveraging global partnerships and strong in-house engineering capabilities**
- › **Increasing efficiencies across manufacturing facilities through operational excellence, digitalisation, etc.**

## RANE BRAKE LINING

- Won orders worth Rs. 35 Cr from various customers

## RANE ENGINE VALVE

- Won orders worth Rs. 10 Cr from various customers

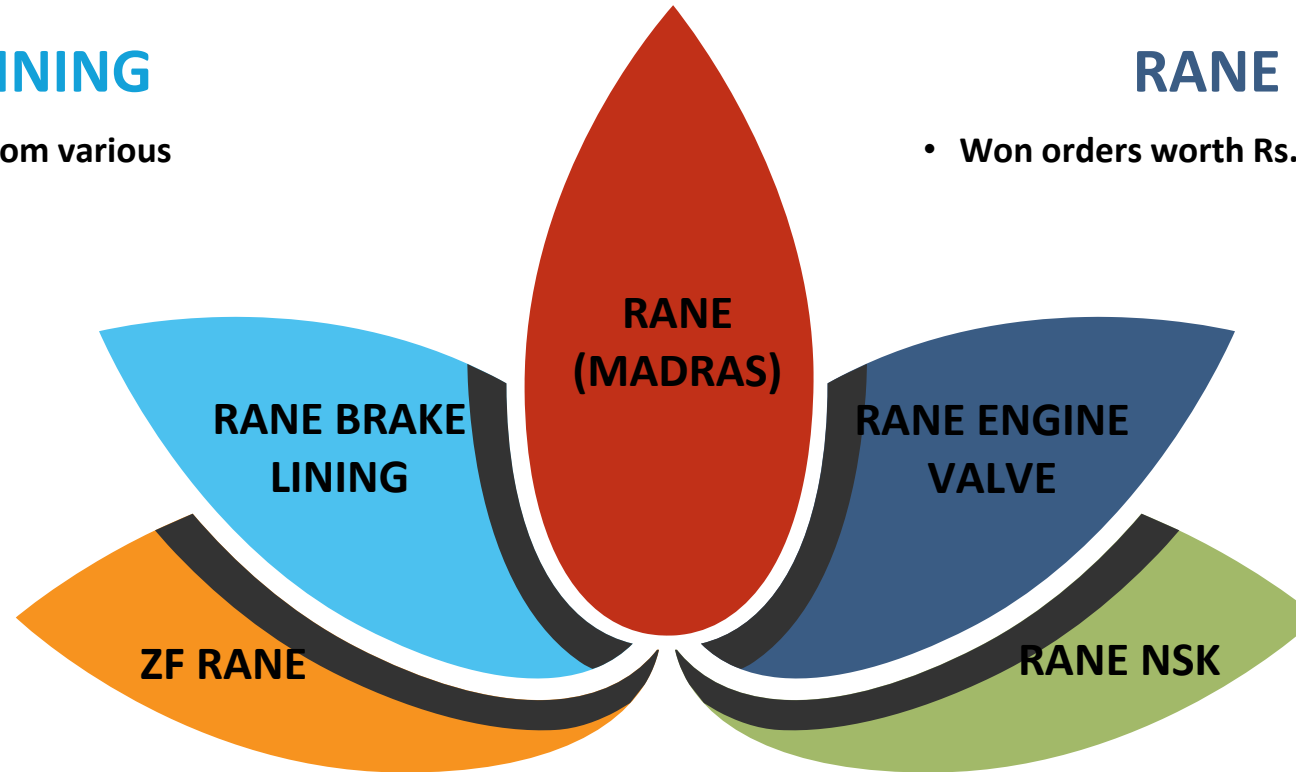

## ZF RANE

- Won orders worth Rs. 240 Cr for Occupant safety products
- Won orders worth Rs. 155 Cr for Steering gear products





## RANE (MADRAS)

- Won Rs. 105 Cr orders from various domestic and international customers for Steering products

## RANE NSK

- Won new business worth Rs. 75 Cr for Manual Steering Column from various customers

# We continue to target higher than the industry growth

Industry Performance Review (H1 FY23)	 Passenger Vehicle	 Commercial Vehicle	 Farm Tractor	 2-Wheeler
	36%	56%	5%	20%
Rane Group Sales Growth YoY in % (India OEM)	34%	71%	15%	34%
	61%	26%	7%	3%
	<ul style="list-style-type: none"> <li>Lower growth than the industry due to lower growth of few served models</li> </ul>	<ul style="list-style-type: none"> <li>Higher share of business and higher growth with served models/customers</li> </ul>	<ul style="list-style-type: none"> <li>Performance is better than industry due to increase in power steering penetration</li> </ul>	<ul style="list-style-type: none"> <li>Better performance is driven by higher offtake of valve train products</li> </ul>

## Market Commentary

- Easing of semiconductor shortage drives demand from Indian PV customers
- Experiencing demand up-cycle in the CV segment
- Seasonally low quarter for Farm Tractor segment
- Demand for our products remained favourable in international markets albeit growing signs of slowdown due to geo political issues and monetary tightening
- Seeing plateauing of commodity prices and expect some softening in the coming quarters



# Group Aggregate Sales (H1 FY23)

## Total Revenue (Rs cr.)

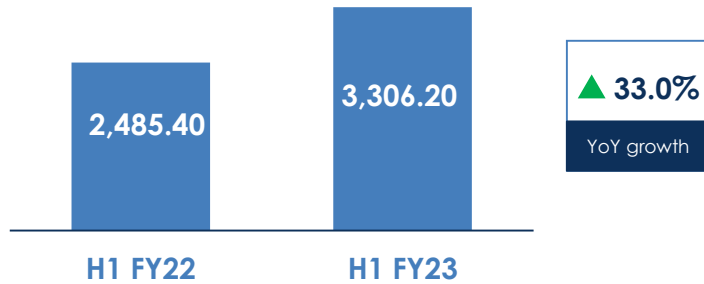

› Total Revenue increased by 33% from Rs. 2,485.4 Cr in H1 FY22 to Rs. 3,306.2 Cr in H1 FY23

- Revenue from Indian OE customers grew 36% supported by strong growth across vehicle segments
- Revenues from International customers increased 25% driven by higher off-take across products
- Revenue from Indian aftermarket segment grew 31%

## Group Aggregate Sales (H1 FY23)

### BY PRODUCT (%)

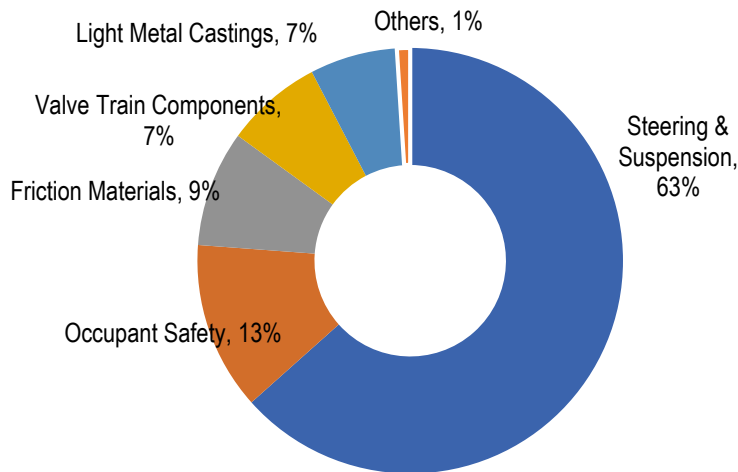

### BY MARKET (%)

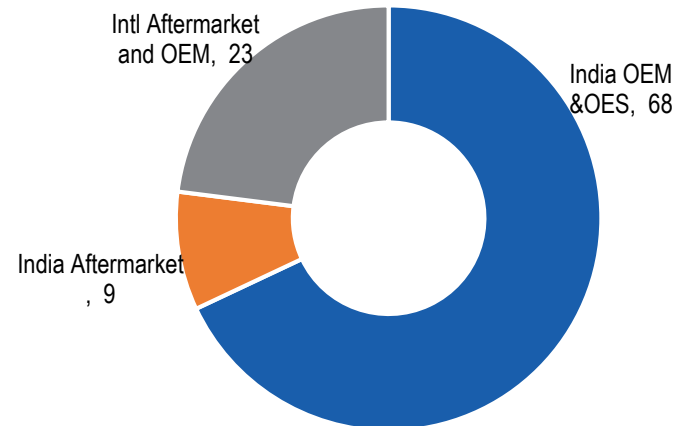

### BY VEHICLE SEGMENT (%)

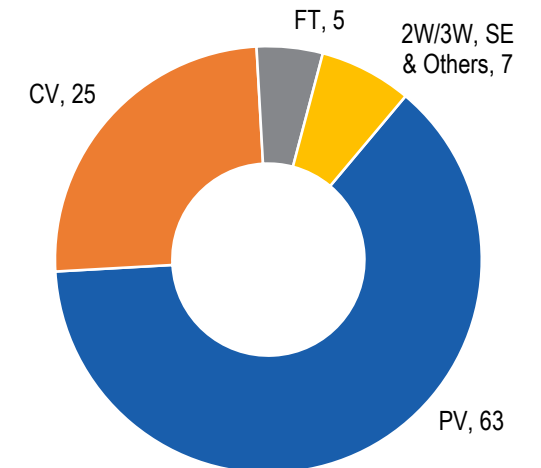

## Total Revenue (Rs cr.)

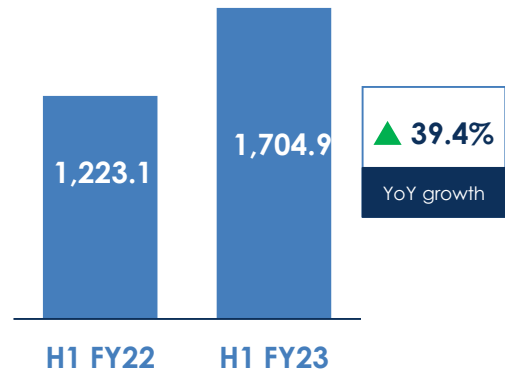

## EBITDA (Rs cr.)

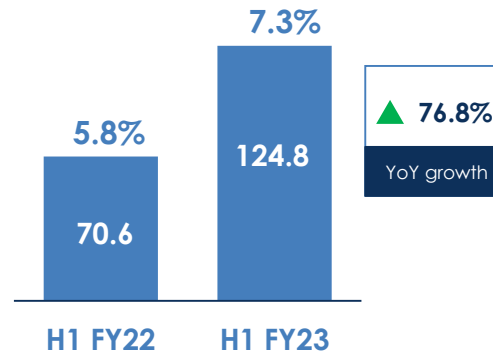

## PAT (Rs cr.)

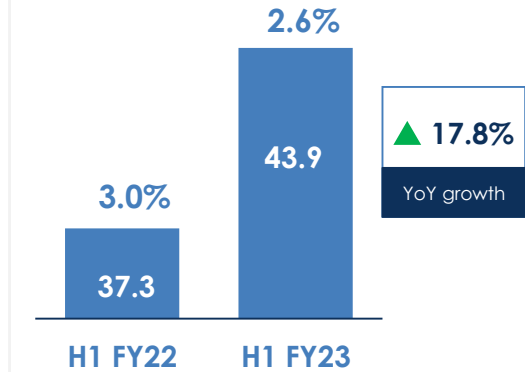

› Total Revenue increased by 39.4% from Rs. 1,223.1 Cr in H1 FY22 to Rs. 1,704.9 Cr in H1 FY23

› EBITDA increased by 76.8% from Rs. 70.6 Cr in H1 FY22 to Rs. 124.8 Cr in H1 FY23

– EBITDA margin increased 155 bps supported by higher volumes and improved operational performance. Higher commodity prices limited the profitability improvement.

› PAT increased by 17.8% from Rs. 37.3 Cr in H1 FY22 to Rs. 43.9 Cr in H1 FY23



# **Rane (Madras) Limited**

**H1FY23 Financial & Operational Performance**



## Business Drivers

- › Strong order book pipeline for Steering and Linkages products
- › Financial turnaround of Light Metal Castings India business with increasing capacity utilization and operational improvements
- › Aftermarket segment primed to grow aggressively with new product introductions

## Operational Highlights

- › Certified as a 'Great Work place' by GPTW Institute, India – for 5th consecutive year
- › Won the runner up award in Ashok Leyland's National Supplier Samrat competition in the Proprietary category
- › Received award from Tata Motors, Pantnagar for “Energy champion of the year 2021-22”
- › Light Metal Castings India received an Award from Bosch for their performance in the export of Steering Housing Castings
- › LMCA has won the award for Excellence in Aluminum Die Casting in the category of 1-10 Lbs from the North American Die Casting Association (NADCA)

## Business Split (H1 FY23) – RML India

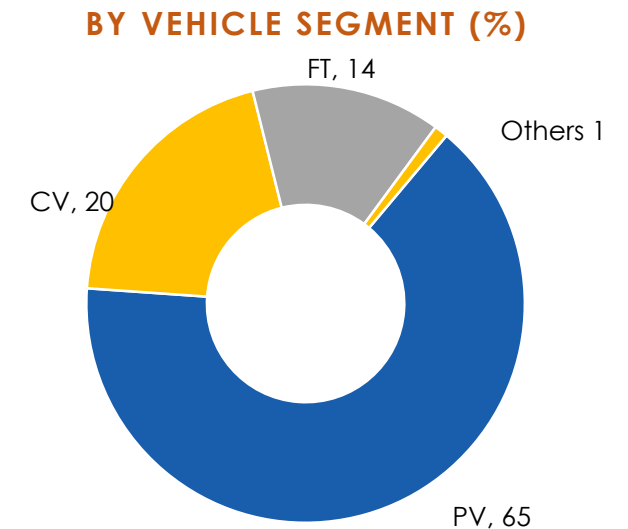
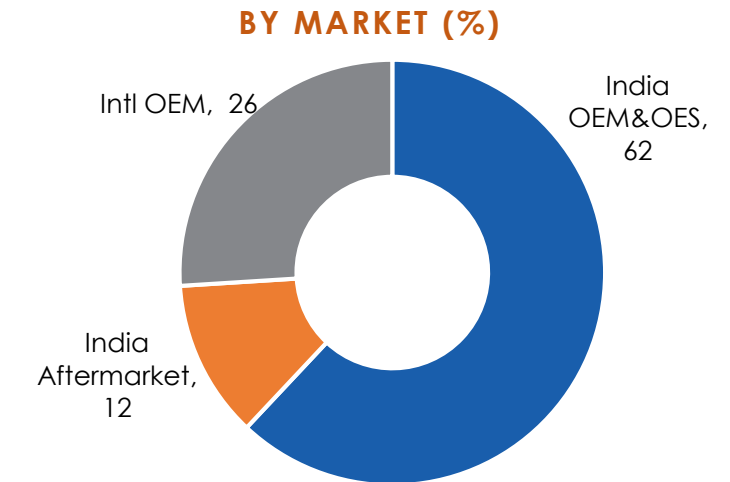

## Total Revenue (Rs cr.)

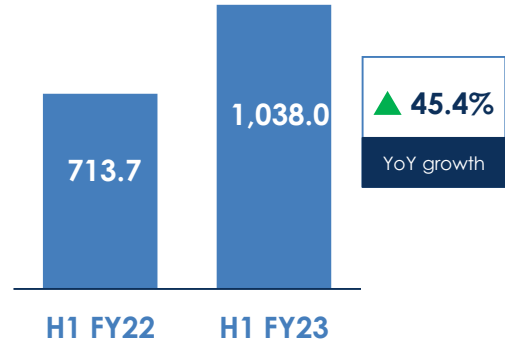

## EBITDA (Rs cr.)

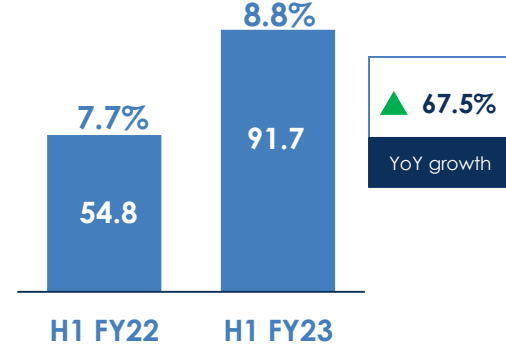

## PAT (Rs cr.)

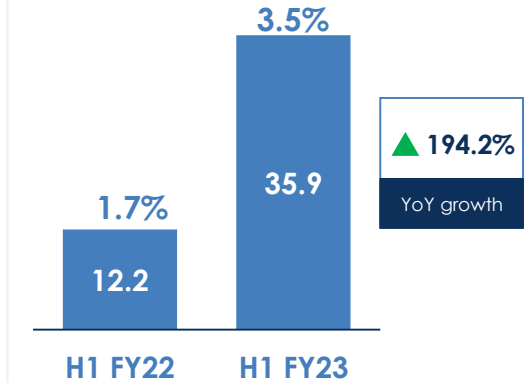

› **Total Revenue increased by 45.4% from Rs. 713.7 Cr in H1 FY22 to Rs. 1,038.0 Cr in H1 FY23**

- Sales to Indian OE customers grew 60% supported by strong demand across vehicle segments.
- Sales to International customers grew 27%. Demand from International customers remained strong.
- Sales to Indian Aftermarket customers grew 25%.

› **EBITDA increased by 67.5% from Rs. 54.8 Cr in H1 FY22 to Rs. 91.7 Cr in H1 FY23**

- EBITDA margin increased by 116 bps supported by higher volumes and improved operational performance

› **PBT increased by 194.2% from Rs. 12.2 Cr in H1 FY22 to Rs. 35.9 Cr in H1 FY23**

## Total Revenue (Rs cr.)

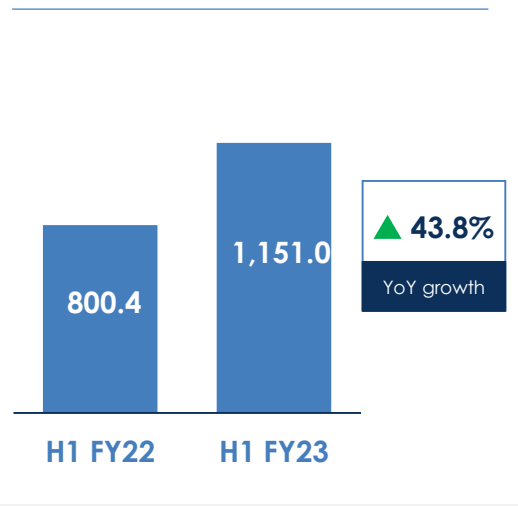

## EBITDA (Rs cr.)

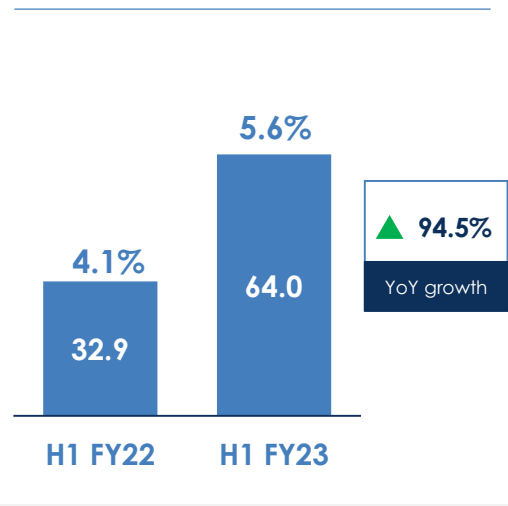

## PAT (Rs cr.)

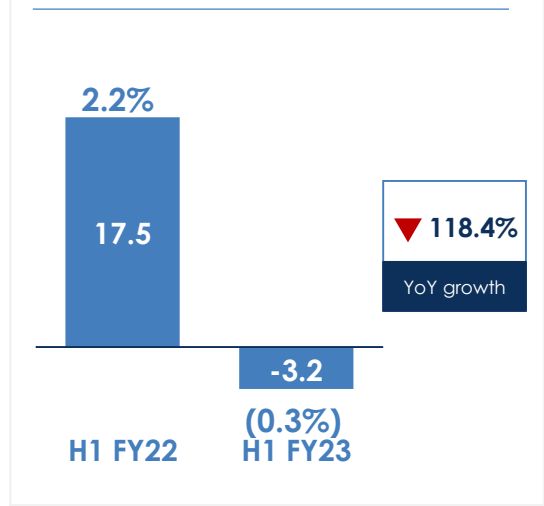

› **Total Revenue increased by 43.8% from Rs. 800.4 Cr in H1 FY22 to Rs. 1,151.0 Cr in H1 FY23**

– Sales of the US subsidiary grew with the improved off-take from customers. However the demand environment in the US remains challenging

› **EBITDA increased by 94.5% from Rs. 32.9 Cr in H1 FY22 to Rs. 64.0 Cr in H1 FY23**

– Better operational performance and higher volumes helped improve profitability

› **PAT declined by 118.4% from Rs. 17.5 Cr in H1 FY22 to Rs. (3.2) Cr in H1 FY23**

– There was a one-off income of USD 5 Mn on account of US Federal stimulus benefits in H1 FY22.



# **Rane Engine Valve Limited**

**H1FY23 Financial & Operational Performance**



## Business Drivers

- › 44% of revenue generated from EV insulated segment
- › Financial turnaround underpins
  - › Higher capacity realization and new business ramp up
  - › Increasing mix of exports and EV insulated segment
  - › Manufacturing cost reduction

## Operational Highlights

- › Certified as a 'Great Work place' by GPTW Institute, India
- › Ramp up in hollow valve production

### Business Split (H1 FY23)

#### BY MARKET (%)

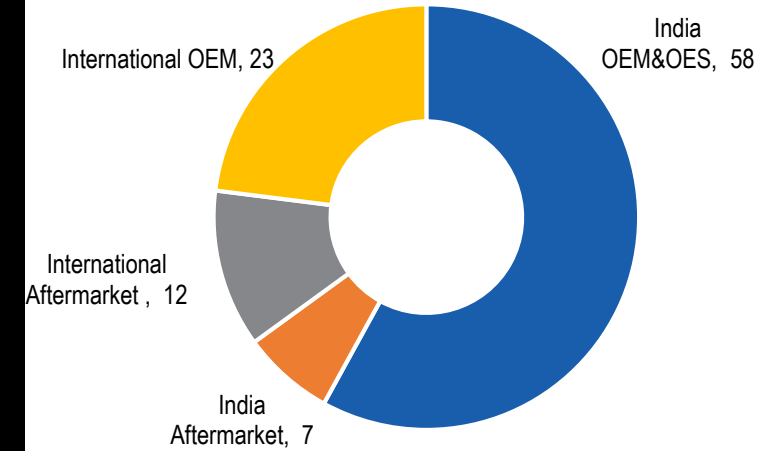

#### BY VEHICLE SEGMENT (%)

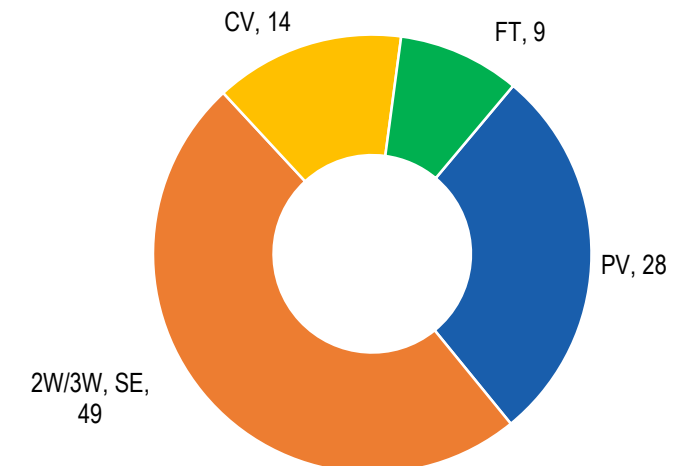



## Total Revenue (Rs cr.)

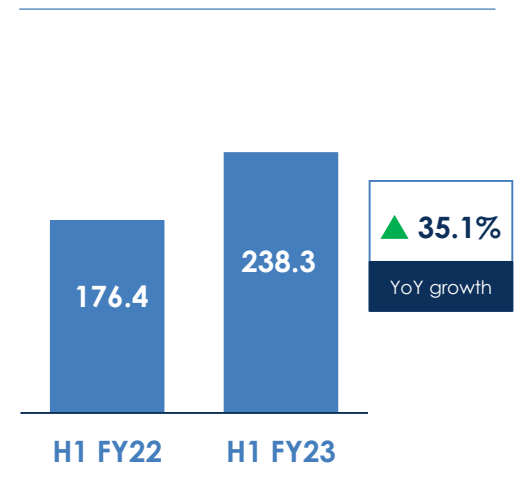

## EBITDA (Rs cr.)

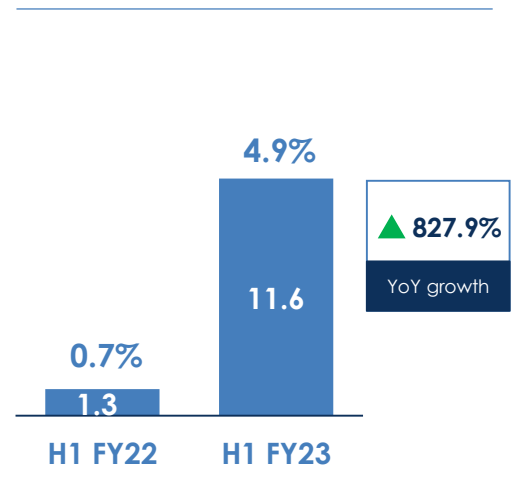

## PAT (Rs cr.)

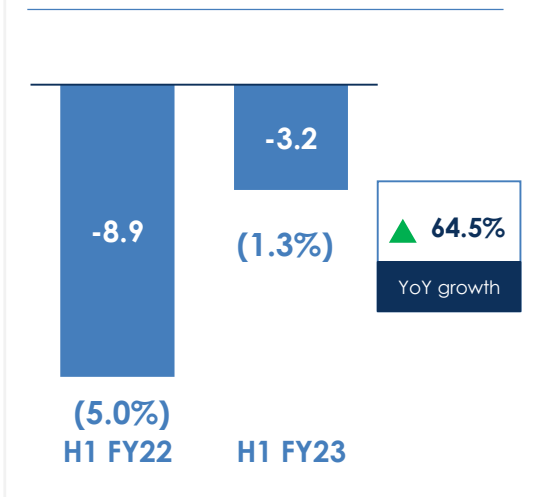

› **Total Revenue increased by 51.3% from Rs. 176.4 Cr in H1 FY22 to Rs. 238.3 Cr in H1 FY23**

- Sales to Indian OE customers grew 50% supported by strong demand across vehicle segments.
- Export Sales grew 55%. Demand from International customers remained strong.
- Sales to Indian Aftermarket customers grew 46%.

› **EBITDA increased by 827.9% from Rs. 1.3 Cr in H1 FY22 to Rs. 11.6 Cr in H1 FY23**

- EBITDA margin improved by 417 bps due to improved operational performance, price recovery from customers and operational leverage on higher volume.

› **Loss reduced by 64.5% from Rs. (8.9) Cr in H1 FY22 to Rs. (3.2) Cr in H1 FY23**



# **Rane Brake Lining Limited**

**H1FY23 Financial & Operational Performance**



## Business Drivers

- › Market leader in Passenger Vehicle segment and increased penetration in two wheeler segment
- › Dominant presence in Aftermarket segment, which accounts for 35% of sales
- › Expanding International Aftermarket business
- › Robust operational performance

## Operational Highlights

- › Won Best Supplier Award in Friction category from Brakes India Pvt. Ltd.
- › Won 1st prize in National level QC Convention conducted by ACMA.
- › Certified as a 'Great Work place' by GPTW Institute, India – for 6th consecutive year

### Business Split (H1 FY23)

#### BY MARKET (%)

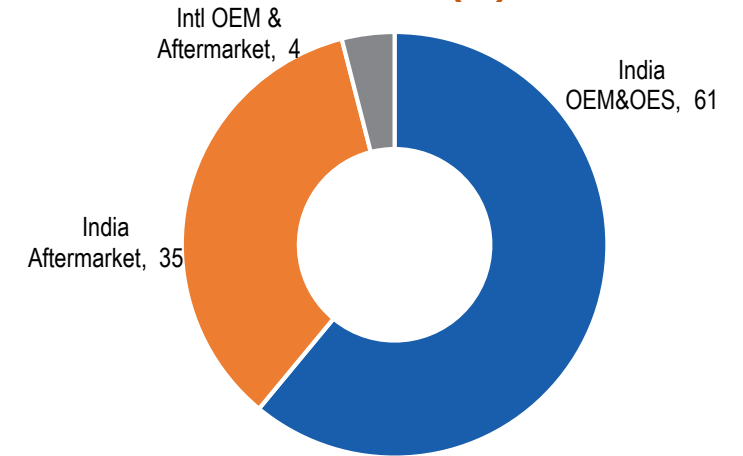

#### BY VEHICLE SEGMENT (%)

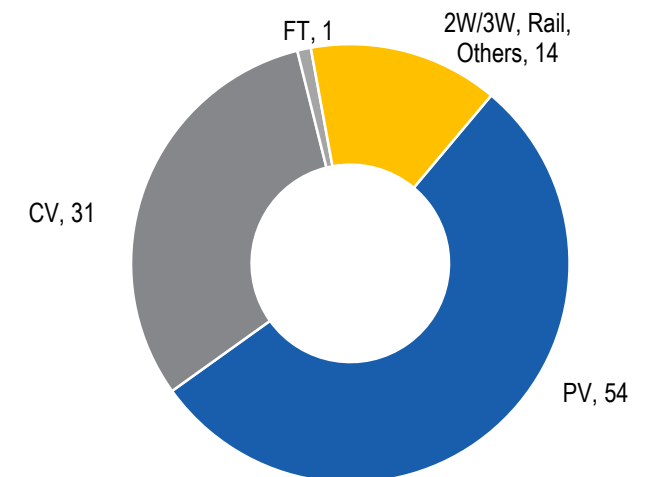

## Total Revenue (Rs cr.)

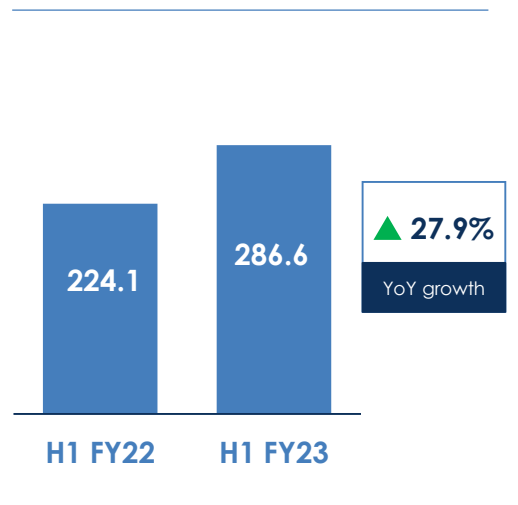

## EBITDA (Rs cr.)

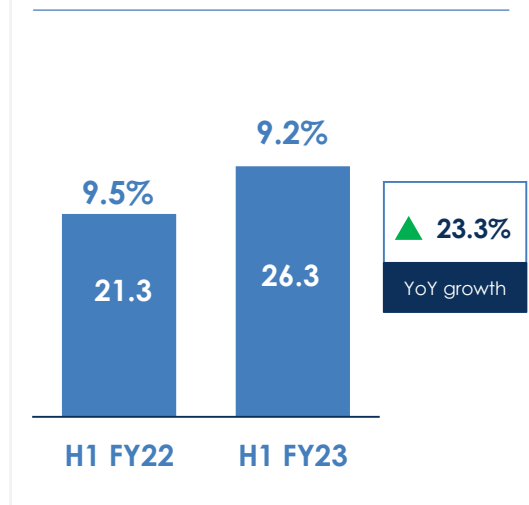

## PAT (Rs cr.)

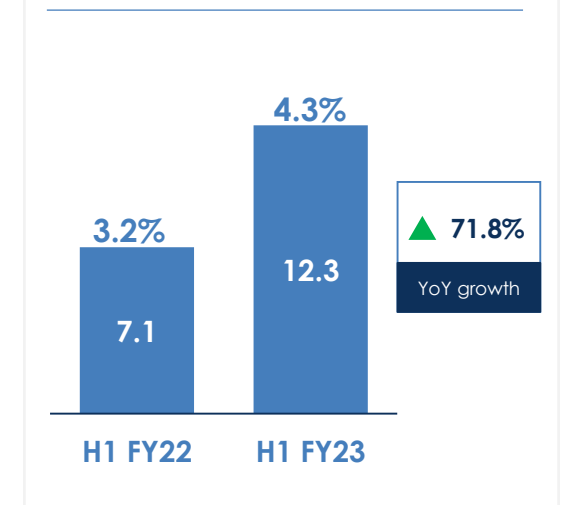

› **Total Revenue increased by 27.9% from Rs. 224.1 Cr in H1 FY22 to Rs. 286.6 Cr in H1 FY23**

- Sales to OE customer grew 36% supported by strong demand across vehicle segments
- Sales to Aftermarket customers grew 93%

› **EBITDA increased by 23.3% from Rs. 21.3 Cr in H1 FY22 to Rs. 26.3 Cr in H1 FY23**

- EBITDA margin decreased by 34 bps due to higher commodity price and unfavourable mix. Higher volumes and improved operational performance helped partially mitigate the higher material cost.

› **PAT increased by 71.8% from Rs. 7.1 Cr in H1 FY22 to Rs. 12.3 Cr in H1 FY23**



# **ZF Rane Automotive India Private Limited**

**H1FY23 Financial & Operational Performance**



## Business Drivers

- › Market upcycle in commercial vehicle segment aids growths in steering division
- › Occupant safety division benefits from evolving safety regulation in India
- › Approved under PLI scheme for localisation of inflator and webbing
- › Introducing latest technology products from Joint Venture partner's product portfolio

## Operational Highlights

- › Certified as a 'Great Work place' by GPTW Institute, India

### Business Split (H1 FY23)

#### BY MARKET (%)

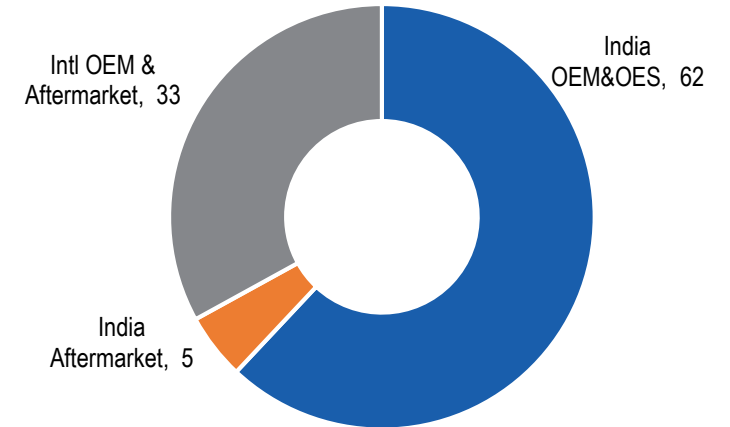

#### BY VEHICLE SEGMENT (%)

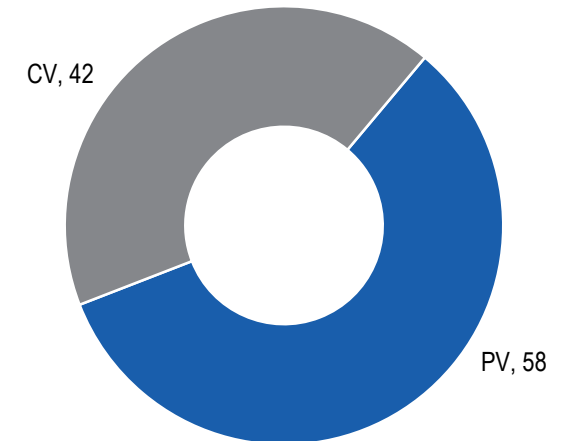

## Total Revenue (Rs cr.)

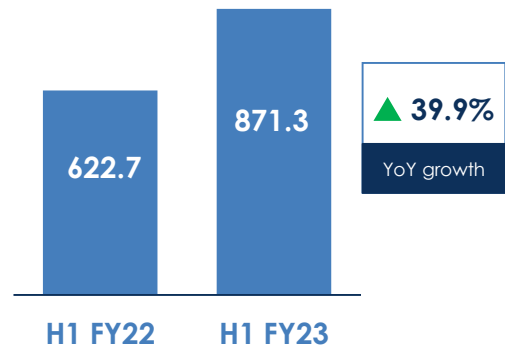

## EBITDA (Rs cr.)

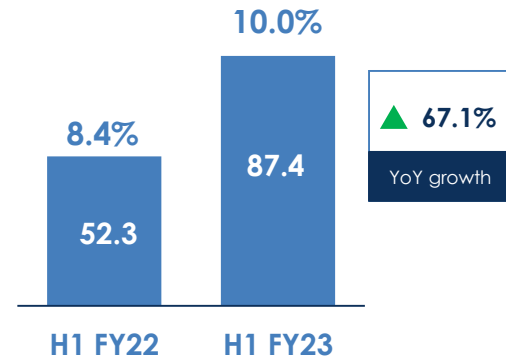

## PAT (Rs cr.)

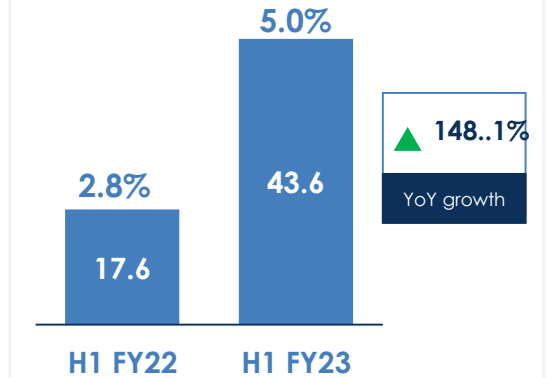

› **Total Revenue increased by 39.9% from Rs. 622.7 Cr in H1 FY22 to Rs. 871.3 Cr in H1 FY23**

- Revenue from steering gear products increased 61% supported by strong demand from commercial vehicle segment
- Revenue from occupant safety systems grew 27% supported by strong offtake on domestic served customers and export customers

› **EBITDA increased by 67.1% from Rs. 52.3 Cr in H1 FY22 to Rs. 87.4 Cr in H1 FY23**

- Favourable product mix and higher volumes helped improve margins

› **PAT increased by 148.1% from Rs. 17.6 Cr in H1 FY22 to Rs. 43.6 Cr in H1 FY23**



# **Rane NSK Steering Systems Private Limited**

**H1FY23 Financial & Operational Performance**





## Business Drivers

- › Favourable share of business with key customer
- › Strong growth for Manual Steering Column product with new product introductions

## Operational Highlights

- › Operates with optimal capacity utilization
- › Guduvancherry plant won the National Award for Excellence in Energy Management - 2022" at CII 21st Energy Efficiency Summit - 2022, New Delhi.

## Business Split (H1 FY23)

### BY MARKET (%)

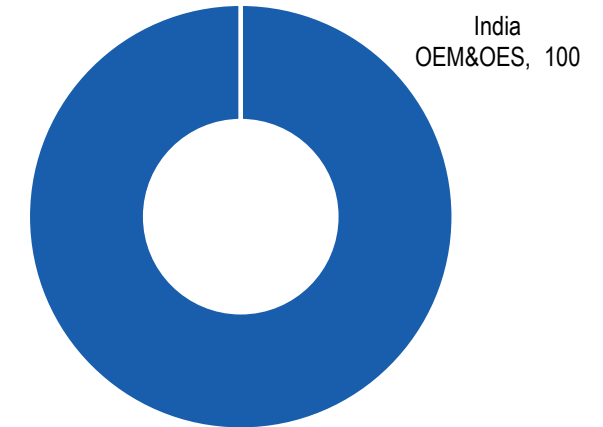

### BY VEHICLE SEGMENT (%)

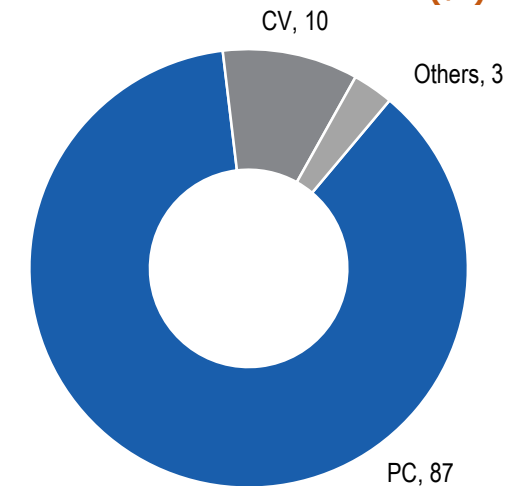

## Total Revenue (Rs cr.)

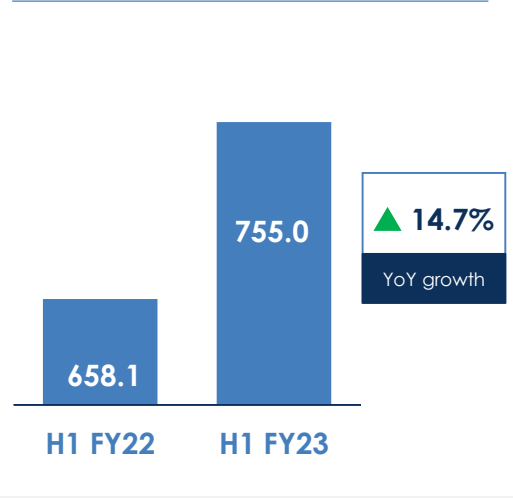

## EBITDA (Rs cr.)

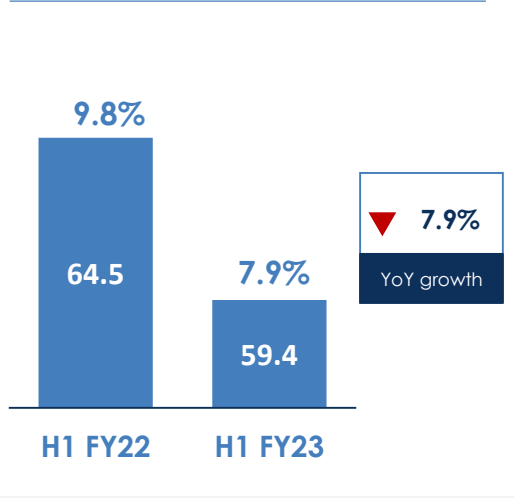

## PAT (Rs cr.)

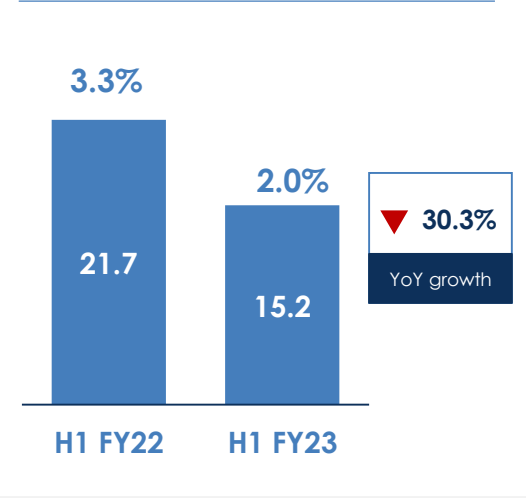

- › **Total Revenue increased by 14.7% from Rs. 658.1 Cr in H1 FY22 to Rs. 755.0 Cr in H1 FY23**
  - Manual steering column business benefitted on account of upcycle in the CV segment
  - EPS business faced slower demand on served models due to semiconductor shortage
- › **EBITDA decreased by 7.9% from Rs. 64.5 Cr in H1 FY22 to Rs. 59.4 Cr in H1 FY23**
  - Adverse product mix and increase in logistics cost impacted the profitability
- › **PAT decreased by 30.3% from Rs. 21.7 Cr in H1 FY22 to Rs. 15.2 Cr in H1 FY23**



# Rane Group

## About Us





Founded in 1929 and headquartered in Chennai, Rane Group is one of the preferred OE manufacturer and supplier for global auto majors



The Group serves a variety of industry segments: Passenger Vehicles, Commercial Vehicles, Farm Tractors, Two-wheelers, Three-wheelers, Railways and Stationary Engines



Manufactures Steering and Suspension systems, Friction materials, Valve train components, Occupant safety systems, Light metal casting products and provide Connected mobility solutions.

REVENUE BY MARKET (%)

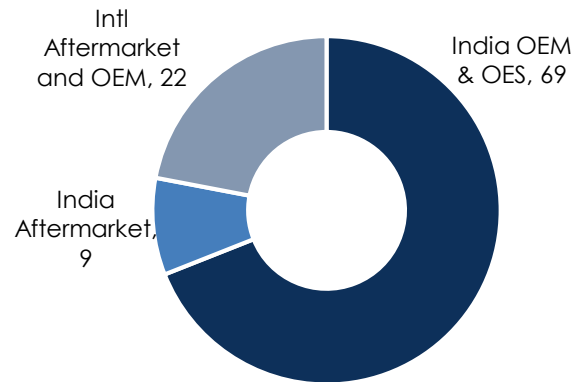

REVENUE BY VEHICLE SEGMENT (%)

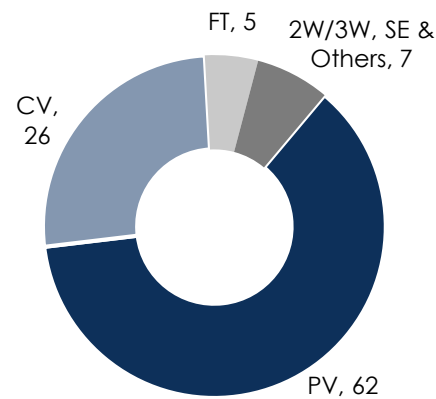

## GROUP SALES OF INR 5,313 CR (~USD 700 MN)

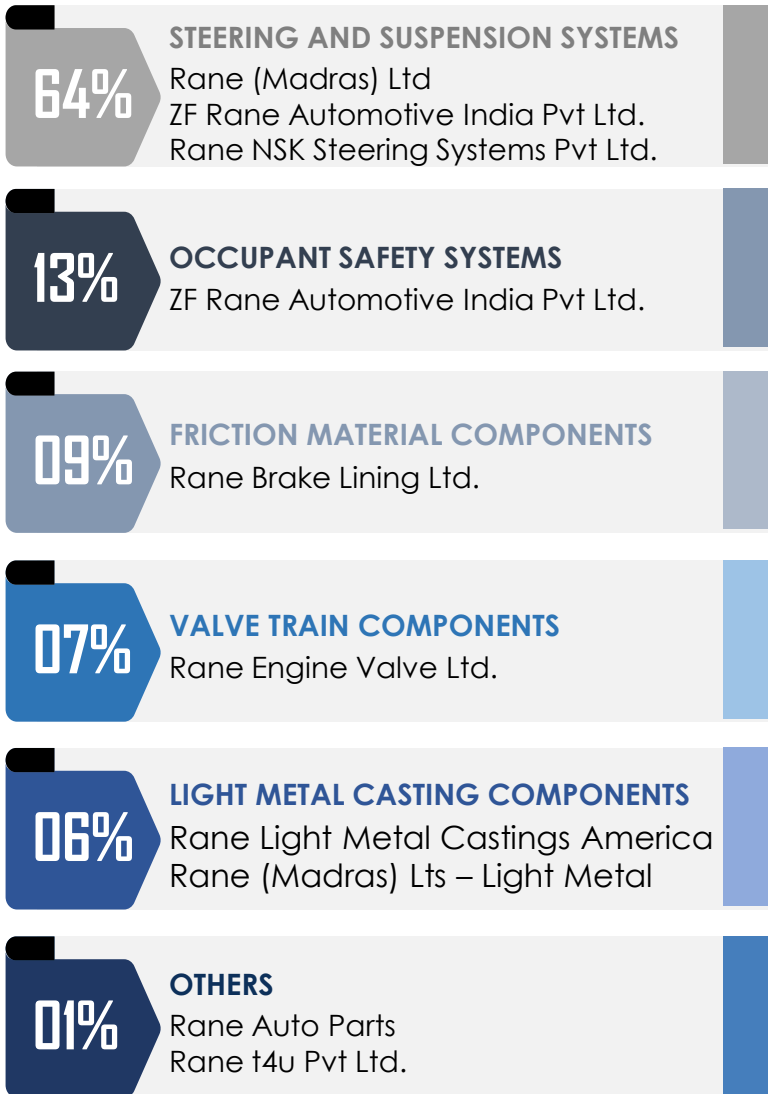

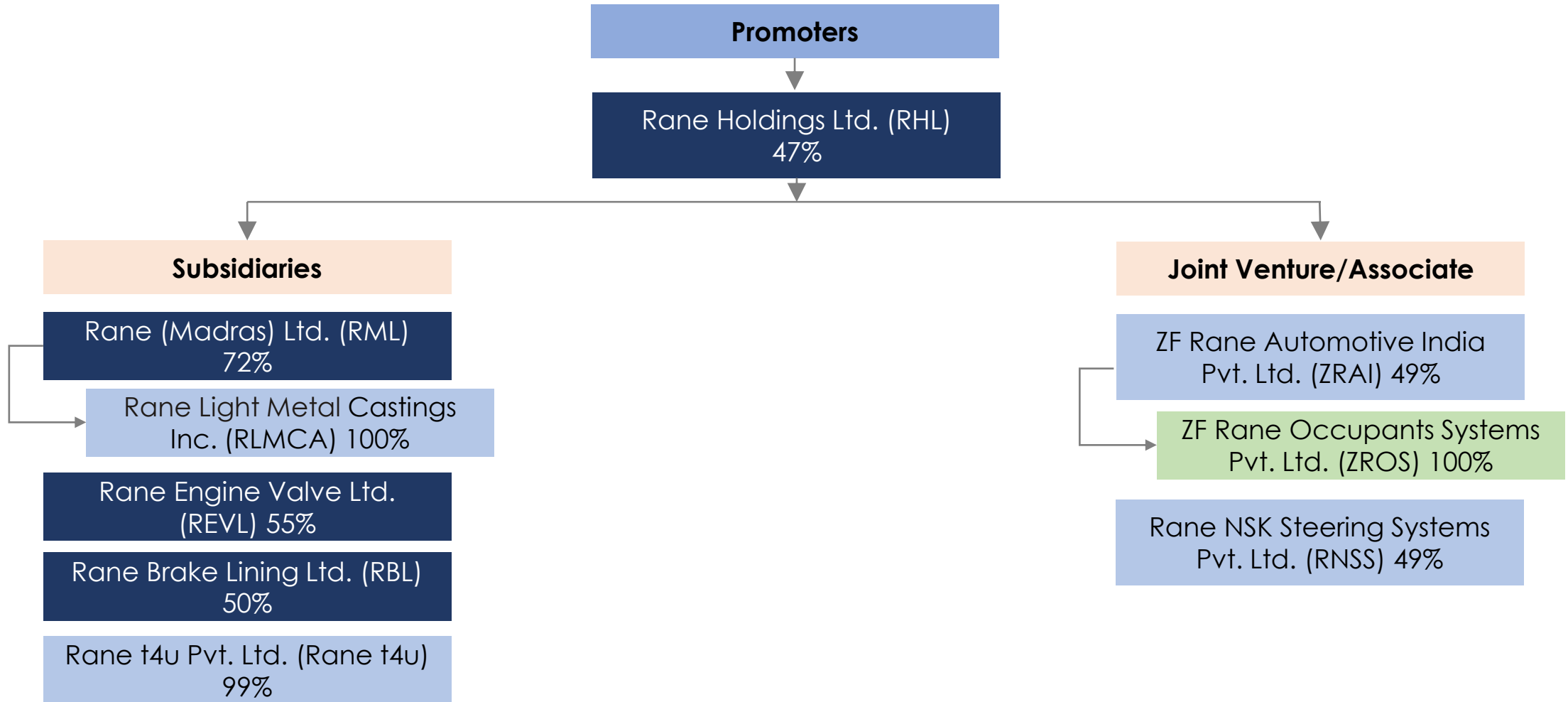

















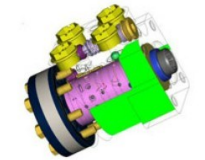

 Listed

Share holding as on 30 June 2022

- Market leader in steering gear and steering linkage products in India. We have started catering to hydraulic products such as HSU and steering cylinders.
- Best in class manufacturing facilities at Chennai, Mysore, Puducherry and Pant Nagar.
- End to end testing facilities in house to validate the products' functional, endurance and environmental parameters.

## PRODUCTS

Steering and Linkage Business		Light Metal Castings India Business			Light Metal Castings AMERICA Business	
						
Manual Steering Gears	Suspension Components	Hydraulic Pinion Housings	Pump Housings	EPAS – Pinion & Outboard Housings	Hydraulic – Pinion Housing	Outboard Housing
						
Steering Linkages	Hydraulic Products	Luminaries	Timing-Case Cover	Engine Oil Sump	EPAS – Pinion Housing	
						
		Gear Case	Brake Housing		HVAC Applications	Valve Housing
						
		Battery Housing	Transmission Housing			

## MANUFACTURING PLANT

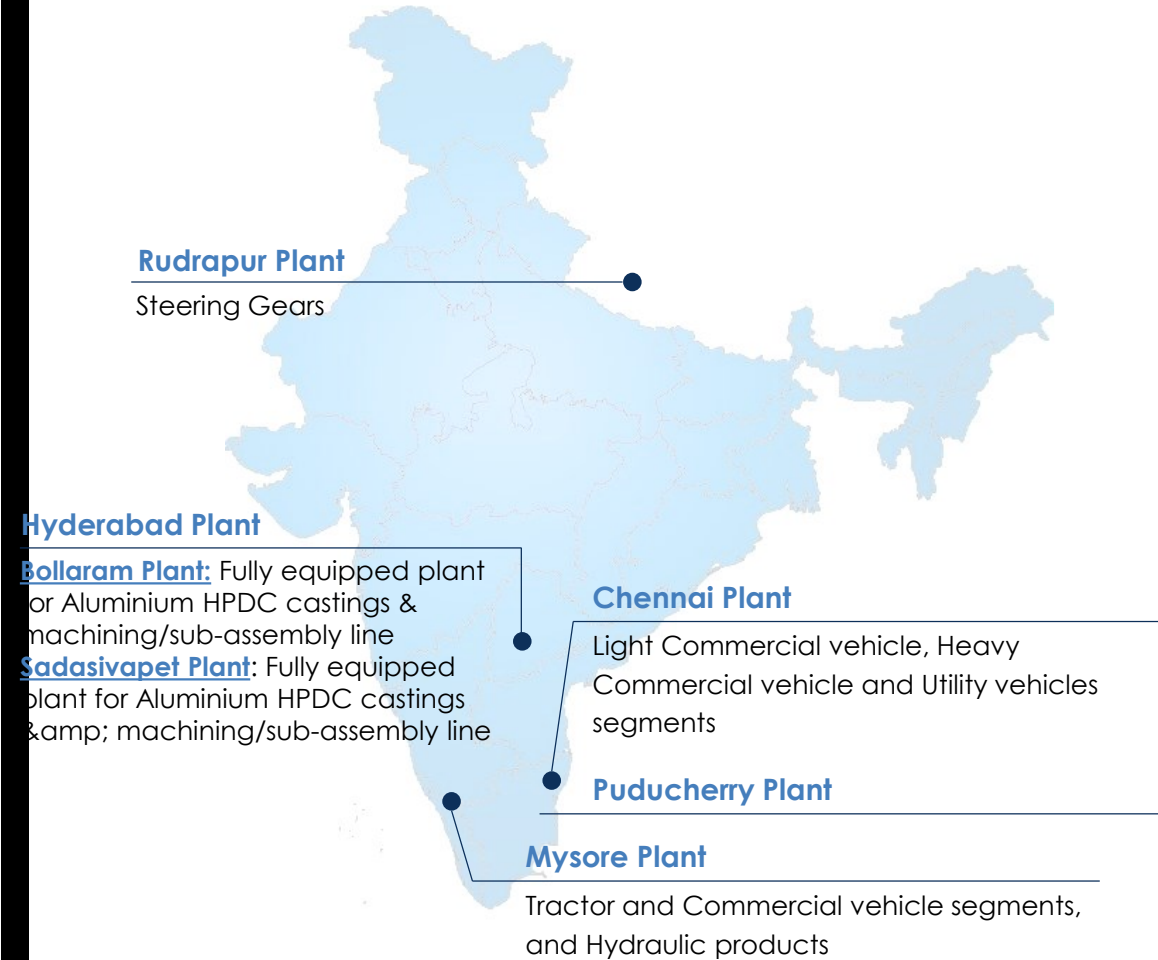

**Rudrapur Plant**  
Steering Gears

**Hyderabad Plant**  
**Bollaram Plant:** Fully equipped plant for Aluminium HPDC castings & machining/sub-assembly line  
**Sadasivapet Plant:** Fully equipped plant for Aluminium HPDC castings & machining/sub-assembly line

**Chennai Plant**  
Light Commercial vehicle, Heavy Commercial vehicle and Utility vehicles segments

**Puducherry Plant**

**Mysore Plant**  
Tractor and Commercial vehicle segments, and Hydraulic products

- Incepted In 1959, REVL manufactures valves and valve train components for various engine applications
- Non Automotive applications such as power generation, marine, defence, locomotive, etc.
- Comprehensive test laboratory for material characterisation, simulated test rigs and engine dynamometer test facility.

## PRODUCTS

Engine Valves



Valve Guides



Mechanical Tappets



## MANUFACTURING PLANT

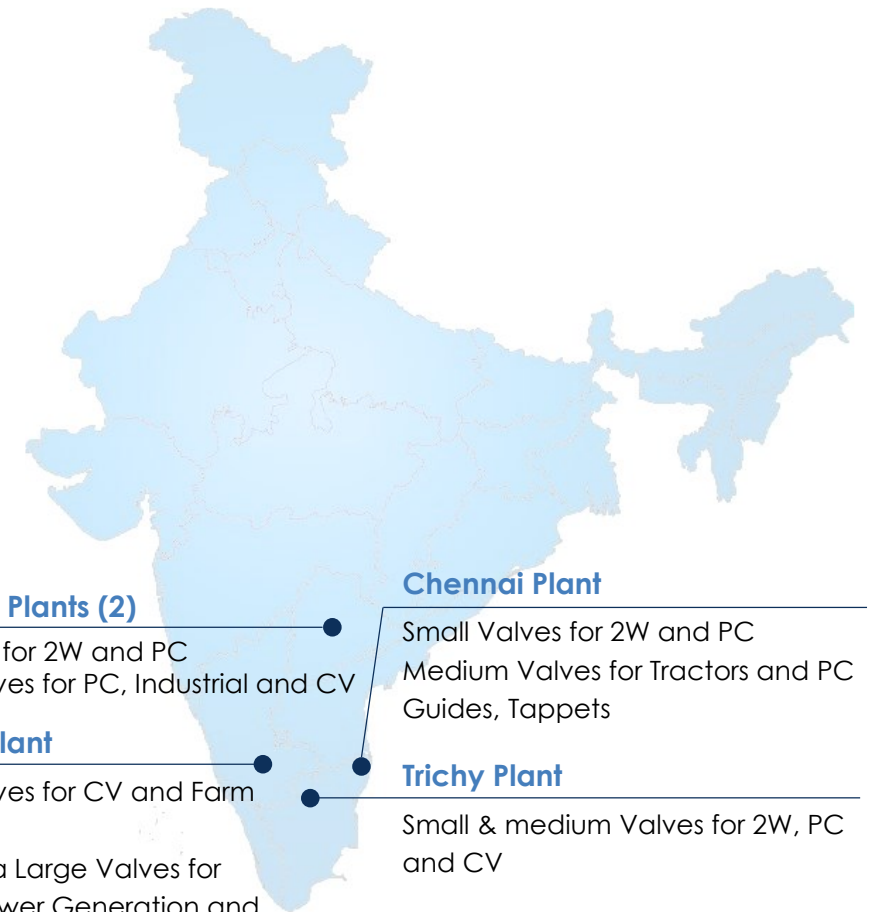

### Hyderabad Plants (2)

Small Valves for 2W and PC  
Medium Valves for PC, Industrial and CV

### Tumakuru Plant

Medium Valves for CV and Farm Tractors  
Large & Extra Large Valves for Industrial, Power Generation and Marine Applications

### Chennai Plant

Small Valves for 2W and PC  
Medium Valves for Tractors and PC Guides, Tappets

### Trichy Plant

Small & medium Valves for 2W, PC and CV

- Established in 1964, RBL is a leader in Friction Products across OEM segments and supplies products to over 15 countries
- Technical collaboration with Nisshinbo Brakes Inc. and TMD Friction
- Library of widely tested and approved formulations to suit diverse market / customer requirements.
- State-of-the-art R&D center equipped with full scale inertia dynamometer, static mu-measurement and NVH study rig.

## PRODUCTS

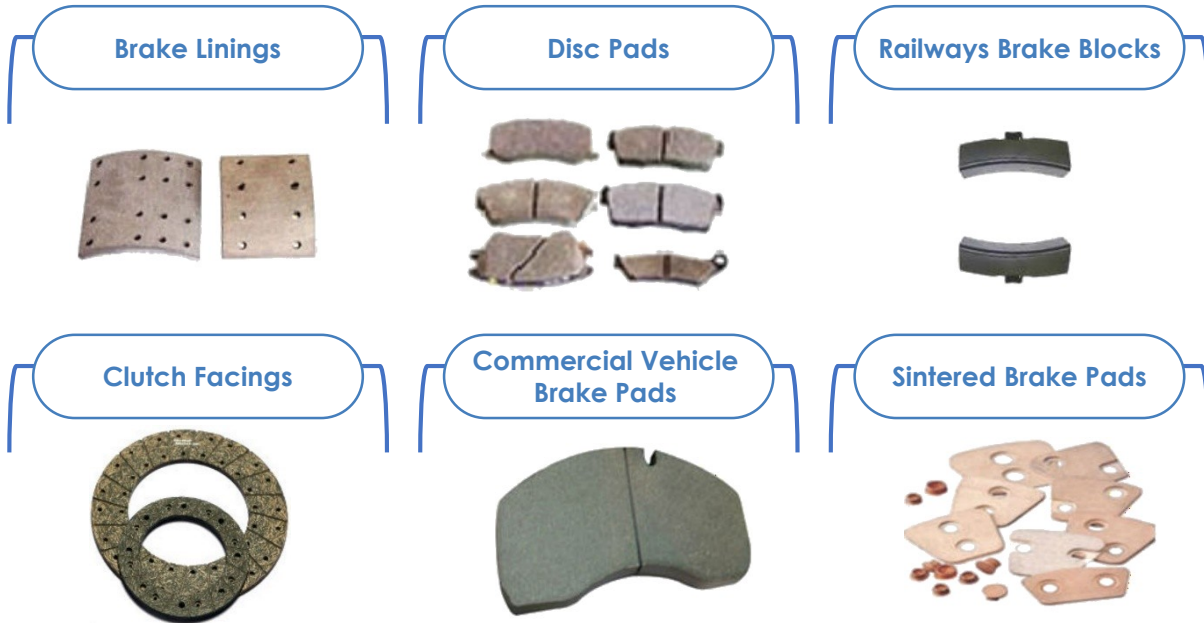

## MANUFACTURING PLANT

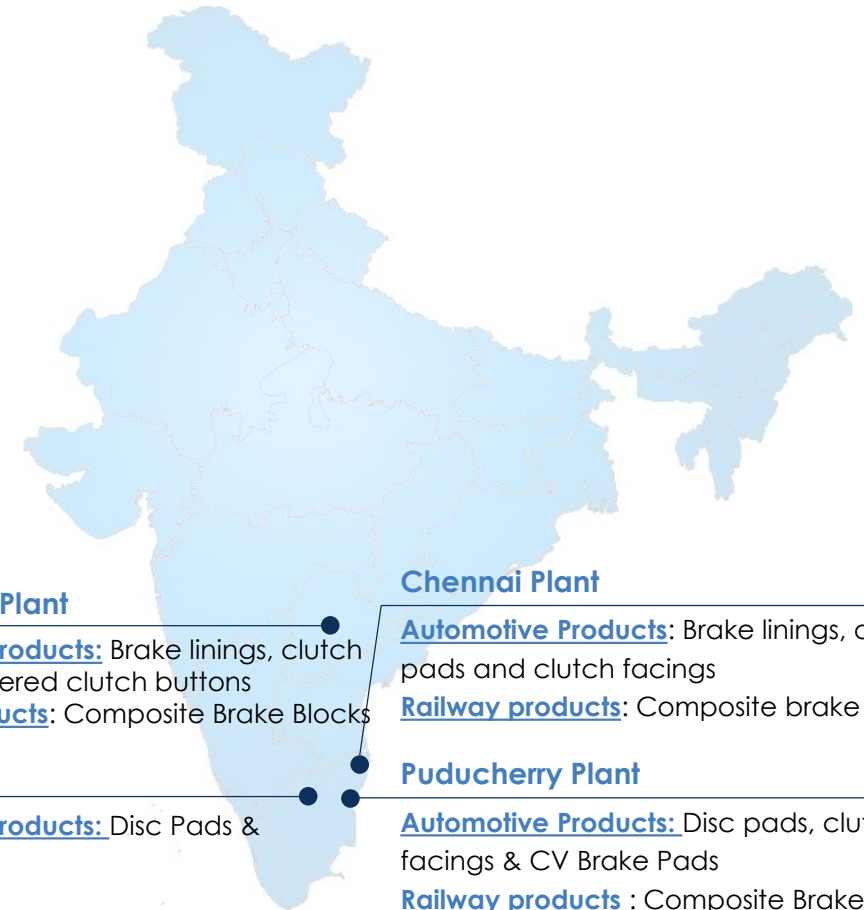

### Hyderabad Plant

**Automotive Products:** Brake linings, clutch facings & sintered clutch buttons

**Railway products:** Composite Brake Blocks

### Trichy Plant

**Automotive Products:** Disc Pads & Brake linings

### Chennai Plant

**Automotive Products:** Brake linings, disc pads and clutch facings

**Railway products:** Composite brake blocks

### Puducherry Plant

**Automotive Products:** Disc pads, clutch facings & CV Brake Pads

**Railway products:** Composite Brake Blocks



Joint venture partnership with ZF Group, Germany.

## Steering Gear Division

- Design, Development and Application capability for complete Hydraulic Power Steering system for all vehicles.
- Advanced design tools for 3D modeling, simulation, FE analysis and CFD.
- State-of-the-art testing facilities for strength, environment, noise, fatigue and durability tests to meet global standards

## Occupant Safety Division

- Product range includes different types of airbags and latest seatbelt technologies, Retractor and Anchor pretensioners, Emergency Locking Retractor (ELR), Load Limiters, Child Restraint Seat Belt, Driver Airbag, Passenger Airbag, Side Airbag and Curtain Airbags.
- Extensive testing facilities for seat belts include Extraction and Retraction Force Testing Machine, Retractor Durability Tester, Hot & Cold Chamber, Salt spray chamber, ELR functional tester.
- Equipped with Test lab to carry out testing as per National (IS/AIS), International (ECE/EEC/GS/VSCC), customer specifications and COP testing

## PRODUCTS

### Steering Gear Division



### Occupant Safety Division



## MANUFACTURING PLANT

### Rudrapur Plant

Steering Gears and Pumps

### Chennai Plant (3)

Pump and Power Rack & Pinion division, Occupant Safety Products

### Tiruchirapally Plant (2)

Fully integrated gear, Occupant Safety Products

- Joint venture partnership with NSK, Japan.
- State-of-art R&D test lab for validation of steering columns.
- Manufacturing facilities across four locations in Chennai, Bawal, Rudrapur & Ahmedabad.
- Design & Development capability for solid & energy absorbing columns. Development and application capability for EPS.
- Driver comfort, Passenger safety, Ergonomics and NVH requirements are kept as targets while designing steering system.
- Comprehensive test laboratory for extensive research about column performance characteristic validation, strength and durability validation and NVH requirements.
- Design team includes CAD & CAM application experts and software analysts.

## PRODUCTS



## MANUFACTURING PLANT

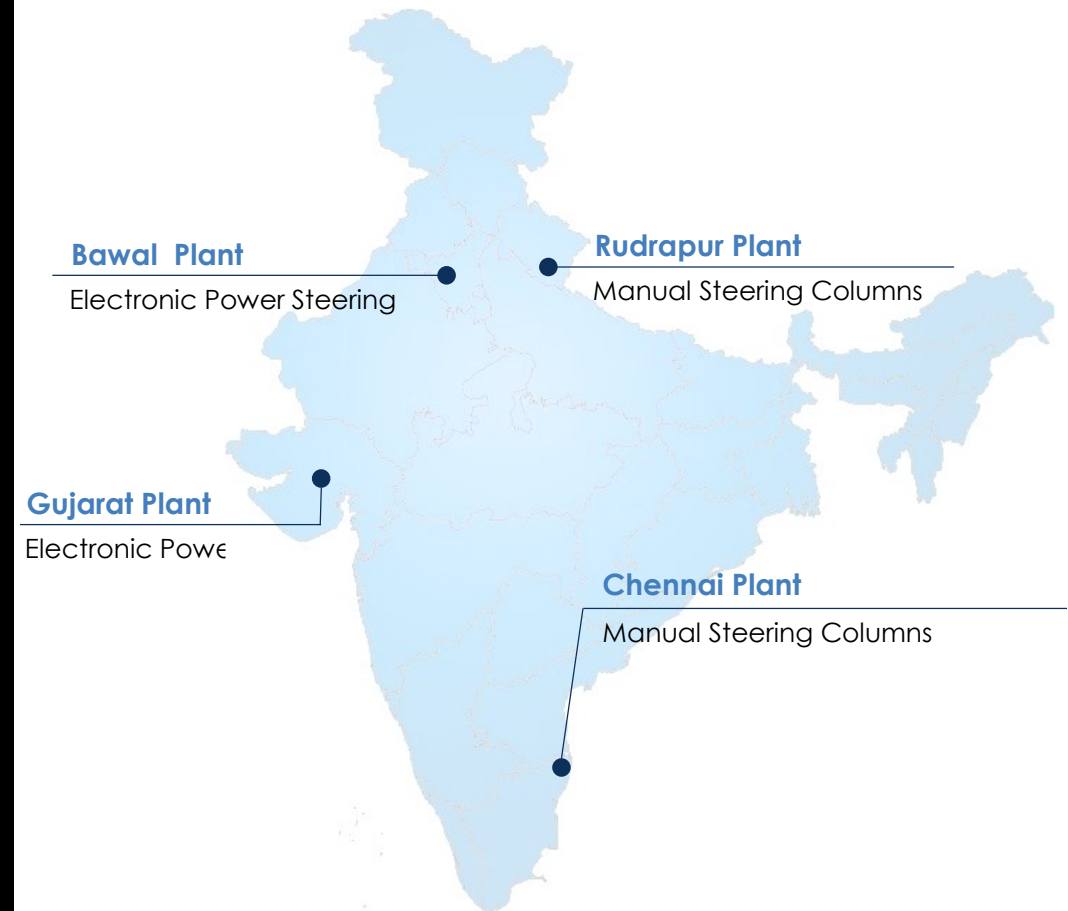

## Light Metal Casting Products

Pinion Housing

Engine Timing Case Cover

Outboard Housing

## Valve train Components

Engine Valves

## Occupant Safety Systems

Seat Belts

Airbags

## Friction Materials

Brake Lining

Disc Pad

Upper Control Arm

Stabilizer Link

Lower Control Arm

## Steering & Suspension Systems

Suspension Ball Joint

Outer Ball Joint

Inner Ball Joint

Power Steering Pump

RACK & PINION steering gear  
-Mechanical  
-Hydraulic

Electric Power Steering Columns

### Rane (Madras)

- › Manual Steering Gears
- › Steering Linkages
- › Suspension Components
- › Light Metal Casting Products

### Rane Engine Valve

- › Engine Valves

### Rane Brake Lining

- › Brake Linings
- › Disc Pads

### Rane NSK Steering Systems

- › Electric Power Steering Systems

### ZF Rane Automotive India Pvt Ltd.

- › Hydraulic Power Steering systems
- › Seat Belts
- › Airbags

## Steering & Suspension Systems



Manual Steering Column



Power Steering Gear



Power Steering Pump



Manual RCB Steering Gear



Drag Link Assembly



Tie Rod Assembly



Hydraulic Cylinder (Twin/multi front axle trucks)

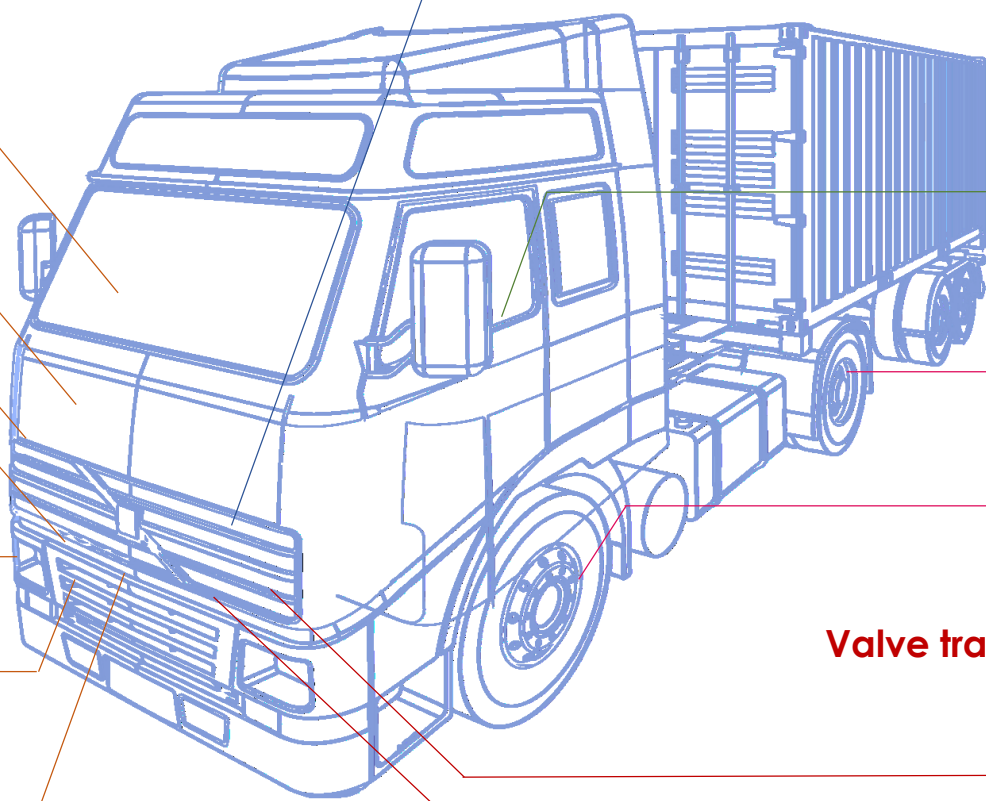

## Light Metal Casting Products

Hydraulic Pump Housing



## Occupant Safety Systems

Seat Belts



## Friction Materials

Brake Lining



Disc Pad



## Valve train Components

Valve Guides



Engine Valves



### Rane (Madras)

- › Manual Steering Gears
- › Steering Linkages
- › Hydraulic Cylinders
- › Light Metal Casting Products

### Rane Engine Valve

- › Engine Valves
- › Valve Guides

### Rane Brake Lining

- › Brake Linings
- › Brake Pads

### Rane NSK Steering Systems

- › Manual Steering Column

### ZF Rane Automotive India Pvt Ltd.

- › Hydraulic Power Steering Systems
- › Seat Belts

## Steering & Suspension Systems



Manual Steering /  
Column  
Manual RCB  
Steering Gear



Hydrostatic  
Steering Unit



Power Steering  
Gear



Drag Link Assembly



Tie Rod Assembly



Hydraulic  
Cylinder



## Friction Materials

Clutch Facings



Brake Lining



## Light Metal Casting Products

Timing Case Covers



## Valve train components

Valve Guides



Engine Valves

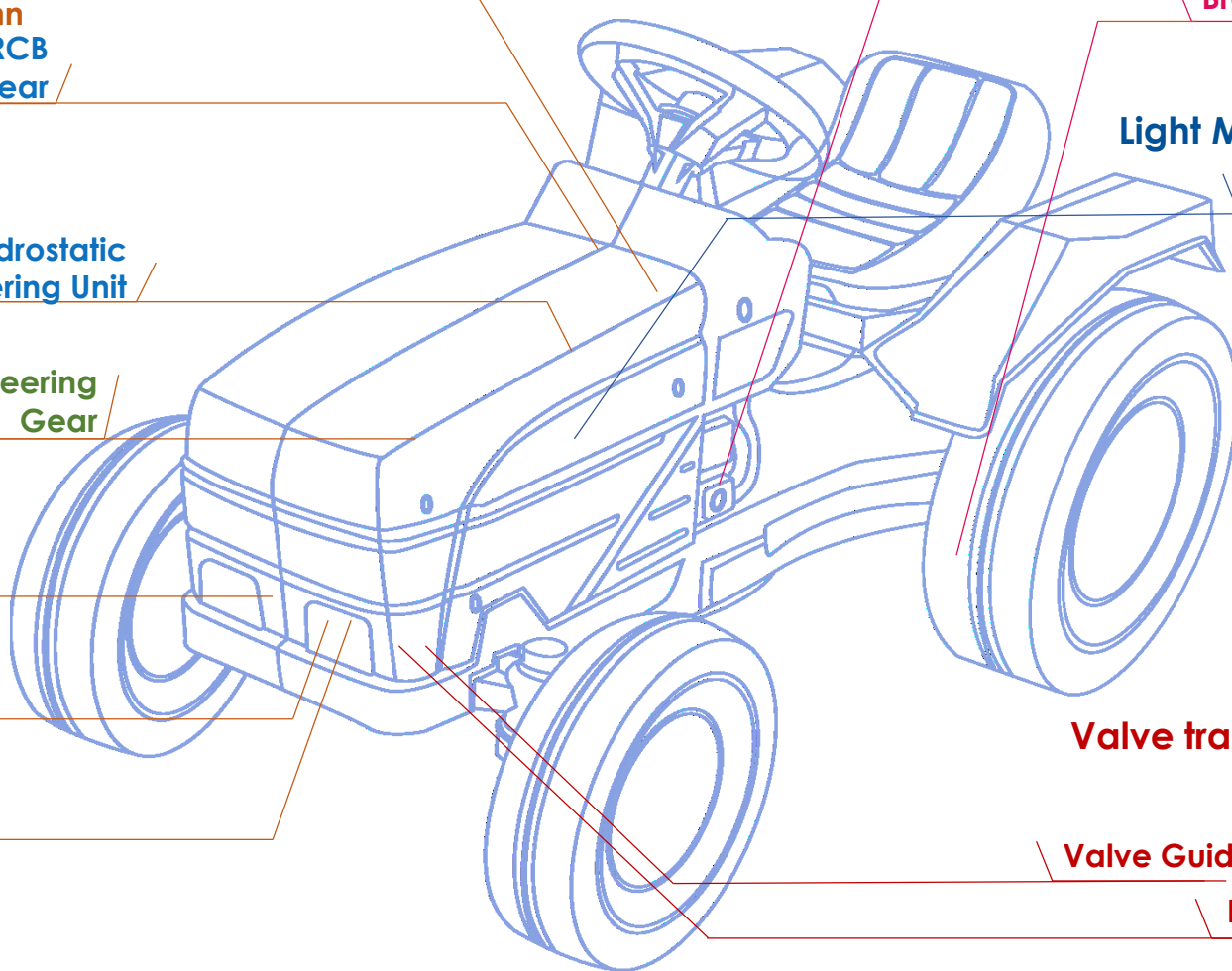

### Rane (Madras)

- › Manual Steering Gears
- › Steering Linkages
- › Hydraulic Cylinders
- › Hydrostatic Steering Unit
- › Light Metal Casting Products

### Rane Engine Valve

- › Engine Valves
- › Valve Guides

### Rane Brake Lining

- › Brake Linings
- › Clutch Facings

### Rane NSK Steering Systems

- › Manual Steering Column

### ZF Rane Automotive India Pvt Ltd.

- › Hydraulic Power Steering systems

## Light Metal Casting Products

### Battery Box & Cover

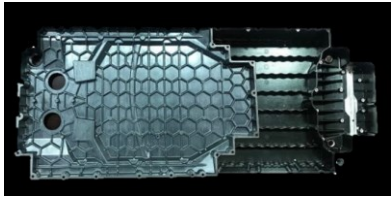

## Friction Materials

### Disc pad

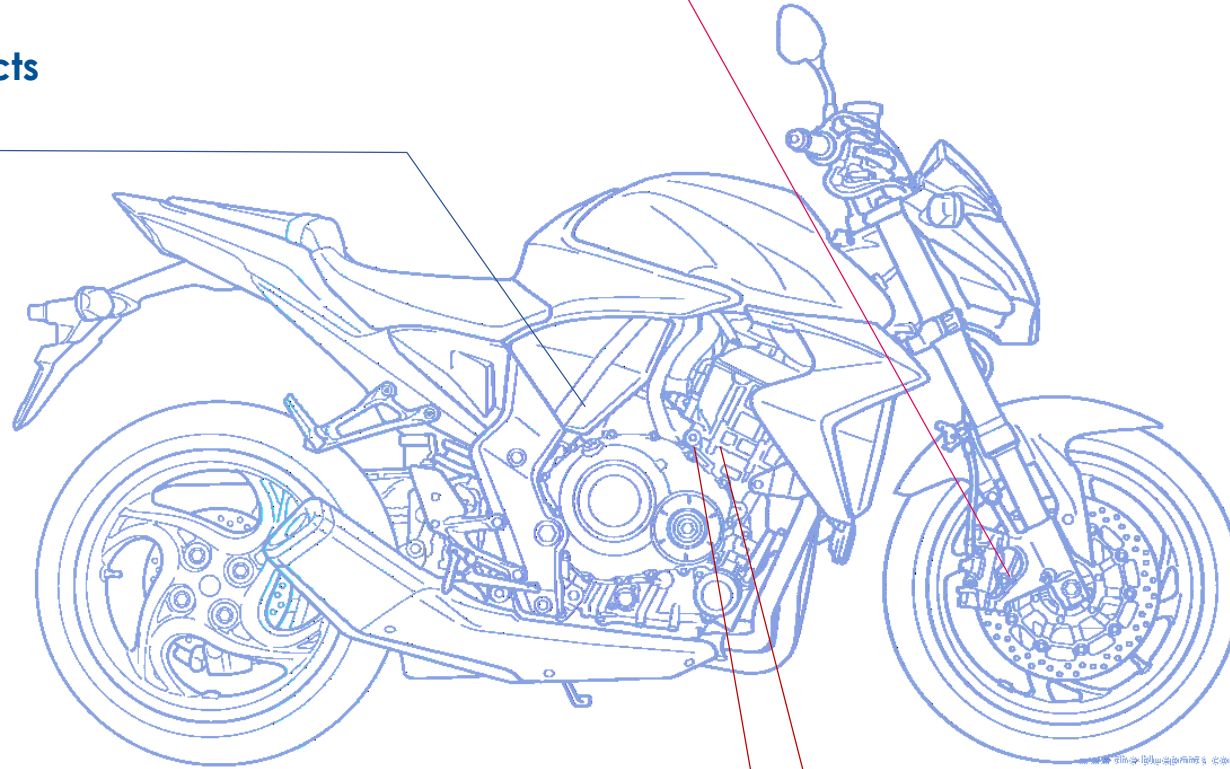

### Rane (Madras)

- › Light Metal Casting Products

### Rane Brake Lining

- › Disc Pads

### Rane Engine Valve

- › Engine Valves
- › Valve Guides

## Valve train Components

### Valve Guides



### Engine Valves



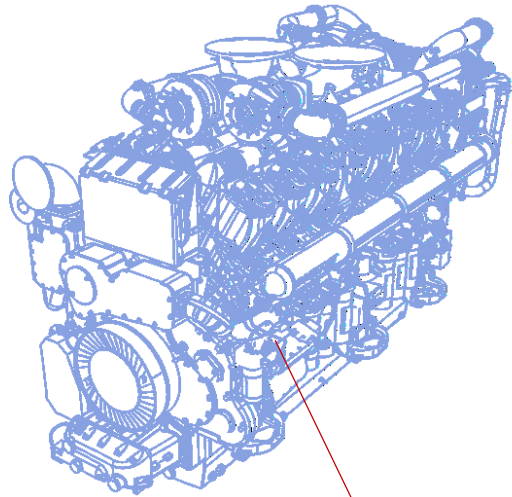

Engine Valves / Valve Guides

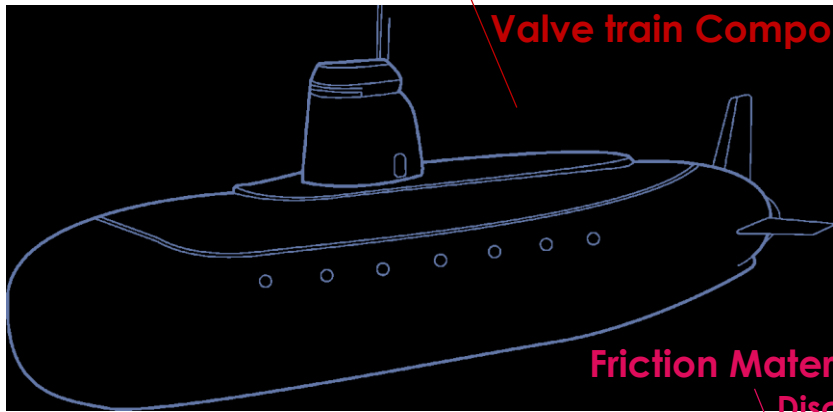

Valve train Components



Friction Materials / Disc pad

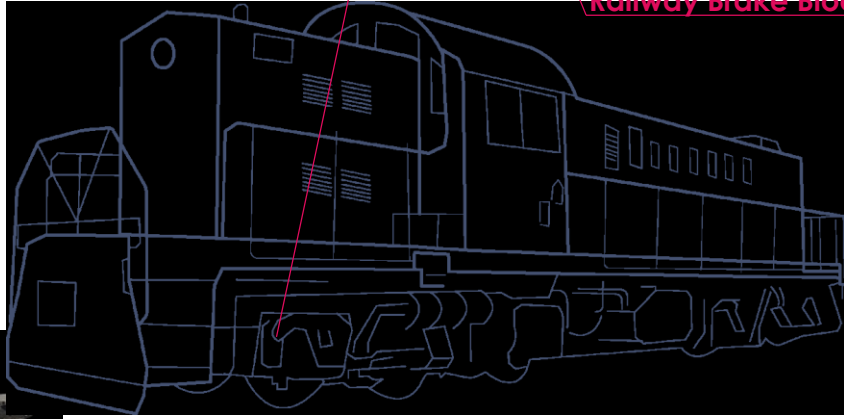

Railway Brake Block



Sintered Brake Pads

Friction Materials

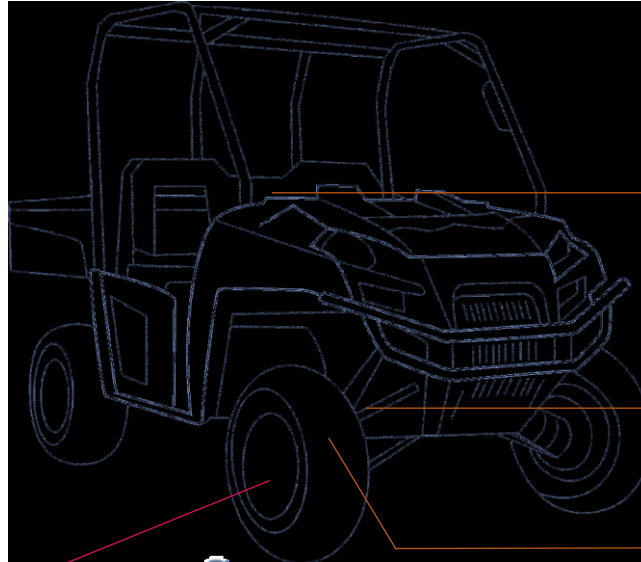

Steering & Suspension Systems



Manual Steering column



Rack & Pinion steering gear -Mechanical



Stabilizer link

- Rane (Madras)**
  - > Manual Steering Gears
  - > Steering Linkages
  - > Light Metal Casting Products
- Rane Engine Valve**
  - > Engine Valves
  - > Valve Guides
- Rane Brake Lining**
  - > Sintered Brake Pads
  - > Railway Brake Block
- Rane NSK Steering Systems**
  - > Manual Steering Column

An illustrious journey of over 80 years from distributor of automobile and auto components to winner of Deming prize for manufacturing

## Distribution

**1929 - 1958**

- › 1929 - Founded as a distributor of automobiles and spare parts
- › 1936 - Incorporated as a Public Ltd. Company

## Manufacturing

**1959 - 1986**

- › Started manufacturing IC Engine Valves, Tie Rod Ends, Friction Material Products and Manual Steering Gears

## Collaboration

**1987 - 2000**

- › Established JV with TRW (currently ZF) and NSK to offer power steering systems, occupant restraint systems and energy absorbing steering columns

## Operational Excellence

**2000 - 2014**

- › TQM Journey with Deming Grand Prize for 3 companies and Deming Prize for 5 companies
- › Started manufacturing high pressure aluminium die cast products, electric power steering and airbags

## Expanding Horizons

**2015 onwards**

- › Established Rane Auto Parts
- › Expanded footprint in USA with the acquisition of Precision Die Casting, Inc.
- › Acquired Rane t4u Pvt. Ltd. , Bengaluru





**30+** Serve customers in 30+ countries

**26** Manufacturing locations across India and USA

Customer Locations   Manufacturing Locations   Sales Offices

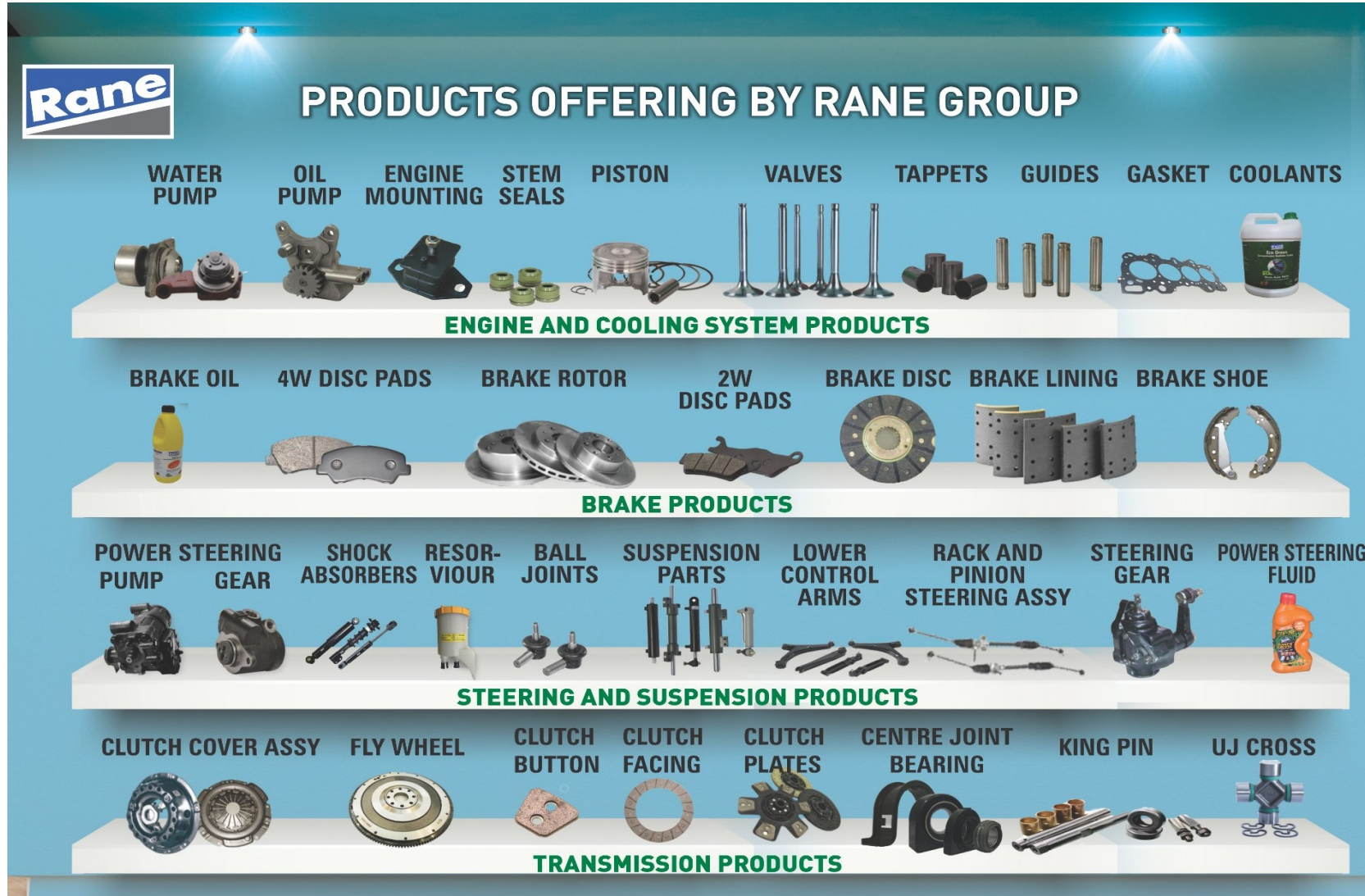

**Rane**

## PRODUCTS OFFERING BY RANE GROUP

**ENGINE AND COOLING SYSTEM PRODUCTS**

- WATER PUMP
- OIL PUMP
- ENGINE MOUNTING
- STEM SEALS
- PISTON
- VALVES
- TAPPETS
- GUIDES
- GASKET
- COOLANTS

**BRAKE PRODUCTS**

- BRAKE OIL
- 4W DISC PADS
- BRAKE ROTOR
- 2W DISC PADS
- BRAKE DISC
- BRAKE LINING
- BRAKE SHOE

**STEERING AND SUSPENSION PRODUCTS**

- POWER STEERING PUMP
- SHOCK ABSORBERS
- RESOR-VIOUR
- BALL JOINTS
- SUSPENSION PARTS
- LOWER CONTROL ARMS
- RACK AND PINION STEERING ASSY
- STEERING GEAR
- POWER STEERING FLUID

**TRANSMISSION PRODUCTS**

- CLUTCH COVER ASSY
- FLY WHEEL
- CLUTCH BUTTON
- CLUTCH FACING
- CLUTCH PLATES
- CENTRE JOINT BEARING
- KING PIN
- UJ CROSS

Increasing Group's brand presence in aftermarket through enhanced product portfolio and wider market reach

## Strong CAE Capabilities – Design, Analysis & Simulation Software

**230** R&D Engineers

**42** Functional Test Rigs

**26** Strength Test Rigs

**62** Durability Test Rigs

**33** Environmental Test Rigs

**10** Noise Test Rigs



Hydraulic Power Steering Systems and Occupant Safety Systems



Energy Absorbing Steering Columns and Electric Power Steering



Brake Linings, Discs Pads and Clutch Facings

Passenger Vehicle

Commercial Vehicle

Farm Tractor

Two/Three-Wheeler

Other Applications

INDIA



INTERNATIONAL



**Customer at the core' remains our priority on the goal to sustainable growth and profitability**



## Rane Group

Customer	Award Category
<b>Mahindra &amp; Mahindra</b>	Business Partner of the year – Automotive Division



## Rane (Madras)

Customer	Award Category
<b>Volvo Eicher</b>	New Product Development Award
<b>Nexteer TAFE</b>	Perfect Quality Award Best Supplier & Benchmark Award
<b>Maruti Suzuki</b>	Superior Performance Award, Special Support
<b>SML Isuzu</b>	New Product Development Award
<b>Tata Motors</b>	Award for Exceptional Support, Best Supplier – Demand Fulfillment
<b>Toyota Industries</b>	Best Target Achieved Supplier Award



## Rane Brake Lining

Customer	Award Category
<b>Brakes India</b>	Best Supplier - Friction
<b>Ashok Leyland</b>	After Market Support Award
<b>Foundation Brake</b>	Business Excellence Award
<b>Endurance</b>	Gold Award for Quality Best Benchmark Award, Best Supplier Award



## Rane Engine Valve

Customer	Award Category
<b>Groupe Renault</b>	Quality & Customer Satisfaction
<b>John Deere India</b>	Quality Appreciation Award
<b>Volvo Eicher</b>	Quality & Delivery excellence
<b>Renault Nissan</b>	Quality & Customer Satisfaction
<b>Hyundai</b>	Appreciation Award
<b>Cummins India</b>	Superior Quality Award



## ZF Rane

Customer	Award Category
<b>Ashok Leyland</b>	Best Performance in Business Alignment-Gold
<b>Isuzu Motors</b>	Most Improved Supplier Award
<b>Tata Motors</b>	Best Supplier Award, Efficiency Award, Best in Class Award
<b>Volvo Eicher</b>	Best Supplier in NPD, Supply Chain
<b>Daimler India</b>	Quality Appreciation Award
<b>Renault Nissan</b>	Best Supplier in Field Quality



## Rane NSK

Customer	Award Category
<b>Maruti Suzuki</b>	Efforts in Vendor Import Localisation
<b>Honda Cars</b>	Award for best reduction in CO2
<b>Volvo Eicher</b>	Kata Award

## Rane Values

- › Provide superior products and maintain market leadership
- › Pursue excellence
- › Achieve the highest standard of ethics and integrity

## Rane Approach

- › Build strong connections with customers to understand their challenges
- › Strategic investments to improve quality and productivity
- › TQM way of working
- › Emphasis on 'First-time right' policy

## Rane Credentials

- › Modern manufacturing facilities with TS 16949 certification
- › State-of-the-art product development and validation capabilities
- › Deming Grand Prize for 3 Rane companies
- › Deming Prize for 5 Rane companies



- › Technology collaboration with top global players



ZF Group, Germany  
Hydraulic Power Steering Systems and Occupant Safety Systems



NSK, Japan  
Energy Absorbing Steering Columns and Electric Power Steering



Nisshinbo Brake Inc., Japan  
Brake Linings, Disc Pads and Clutch Facings

## Value Proposition

- › Superior products driven by execution excellence
- › Trusted partner with shorter development lead times
- › Agile manufacturing process and scalable facilities
- › Provide system-level solutions with deep understanding of customer needs
- › With enhanced R&D capabilities, we provide light-weighting, improved safety and performance

**LONG TERM PARTNER OF CHOICE TO LEADING  
AUTOMOTIVE COMPANIES AND TIER 1 SUPPLIERS**

An exciting workplace founded on the principles of values, fairness and transparency that:



Provides challenging assignments

Encourages learning

Enhances career opportunities



- › **Organisation Development Excellence Award** for the exceptional practices on **Leadership Development** by Transcendence, Tata Institute of Social Sciences (TISS), 2019
- › Recognized by International Federation of Training and Development Organizations in Best HRD practice category, 2018
- › Award for **Talent Management** from the Employer Branding institute, Singapore, 2012 & 2014
- › Significant Achievement in **HR Excellence**, CII, 2012



Certified as a **Great Workplace** by the Great Place to Work institute, 2022



## Systems approach to deliver H&S to our employees

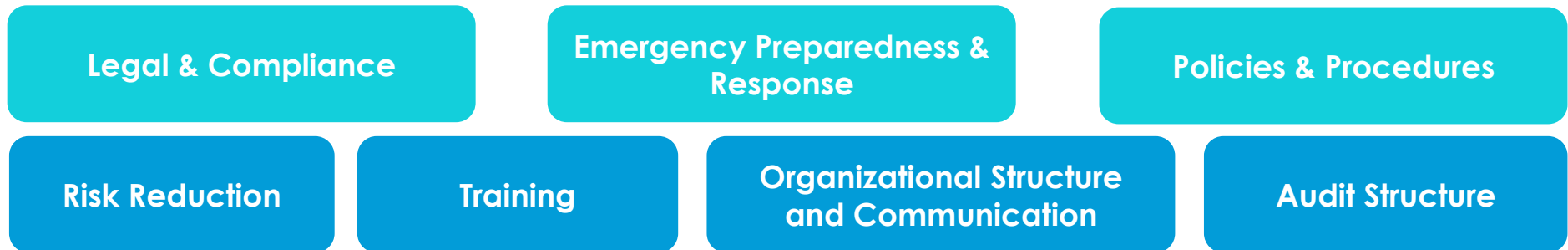

- › Rane Foundation (RF) is a **public charitable trust** founded by Rane's promoters in the year 1967
- › RF is the **main arm for Rane's Corporate Social Responsibility (CSR) initiatives** and is exclusively funded by the Rane companies
- › Initiatives are focused on **education, healthcare, environment and community development**

## Rane Polytechnic



### Education

- › Institution Development - Rane Polytechnic, Rane Vidyalaya
- › Vocational Training & Skill Development
- › Awareness programs



### Healthcare

- › Nutrition program
- › Health camps
- › Medical infrastructure & aid



### Environment

- › Plantation drives
- › Infrastructure for sustainability
- › Natural resource preservation



### Community Development

- › Providing amenities & sanitation
- › Improving quality of life
- › Rural infrastructure development program

## Rane Vidyalaya





# Thank You

For further information, please contact:

[investorservices@ranegroup.com](mailto:investorservices@ranegroup.com) or [diwakar.pingle@in.ey.com](mailto:diwakar.pingle@in.ey.com)

## **Rane Corporate Centre**

"Maithri" 132, Cathedral Road,  
Chennai - 600 086, India  
[www.ranegroup.com](http://www.ranegroup.com)

## Glossary of Abbreviations

Abbreviation	Expansion	Abbreviation	Expansion
ACMA	Automotive Component Manufacturers Association	PBT	Profit Before Tax
bps	Basis point, 100 bps equal to 1%	PC	Passenger Car
BV	Book Value per share	PLE	Production Linked Incentive
Cr	Crores	PPM	Parts Per Million
CV	Commercial Vehicle	Pvt	Private
DPS	Dividend per share	H1	Half Year 1
EBITDA	Earnings Before Interest, Tax, Depreciation and Amortization	SE	Station Engine
FT	Farm Tractors	Rane T4U	Rane T4U Pvt Limited
FY	Financial Year	REVL	Rane Engine Valve Limited
GPTW	Great Place To Work	RHL	Rane Holdings Limited
HR	Human Resource	RLMCA	Rane Light Metal Casting Inc
Intl	International	RML	Rane (Madras) Limited
JV	Joint Venture	RNSS	Rane NSK Steering Systems Pvt Limited
LCV	Light Commercial Vehicles	SCV	Small Commercial Vehicles
Ltd	Limited	SIAM	Society of Indian Automobile Manufacturers
M&HCV	Medium & Heavy Commercial Vehicles	US	United States
Mn	Million	USD	United States Dollar
MPV	Multi Purpose Vehicles	UV	Utility Vehicle
MUV	Multi Utility Vehicles	VRS	Voluntary Retirement Scheme
NPD	New Product Development	YoY	Year-on-Year
OE	Original Equipment	YTD	Year To Date
OEM	Original Equipment Manufacturer	ZRAI	ZF Rane Automotive India Pvt limited
OES	Original Equipment Supplier		(Formerly knowns Rane TRW Steering Systems Pvt Ltd)
PAT	Profit After Tax	ZROS	ZF Rane Occupants Systems Pvt Ltd.
		2W/3W	Two Wheeler/Three Wheeler

*This presentation may contain certain forward looking statements concerning Rane's future business prospects and business profitability, which are subject to a number of risks and uncertainties and the actual results could materially differ from those in such forward looking statements. The risks and uncertainties relating to these statements include, but not limited to risks and uncertainties regarding fluctuations in earnings, our ability to manage growth, competition (both domestic and international), economic growth in India and the target countries for exports, ability to attract and retain highly skilled professionals, government policies and action with respect to investments, fiscal deficits, regulations etc., interest and other fiscal costs generally prevailing in the economy. The company does not undertake to make any announcement in case any of these forward looking statement become materially incorrect in future or update any forward looking statements made from time to time by or on behalf of the Company.*