



Jamna Auto Industries Ltd.

November 14, 2024

To,
BSE Limited
Phiroze Jeejeebhoy Towers,
DalalStreet, Mumbai- 400001
Maharashtra

BSE Code: 520051

To,
National Stock Exchange of India Limited
Exchange Plaza, Plot no. C/1, G Block,
Bandra-Kurla Complex, Bandra (E)
Mumbai - 400051, Maharashtra

NSE Code: JAMNAAUTO

Subject: Investors Presentation on the financial results for the quarter and half year ended September 30, 2024.

Dear Sir/Madam,

Pursuant to the requirements of Regulation 30 and Regulation 46 of SEBI (Listing Obligations & Disclosure Requirements) Regulations, 2015, we are enclosing herewith the presentation by the Company pertaining to the financial results for the quarter and half year ended September 30, 2024.

Kindly take the above information on records

Thanking you,
Yours Faithfully,
For Jamna Auto Industries Limited

Praveen Lakhera
Company Secretary & Head-Legal



Jamna Auto Industries Limited

Investor Presentation

Q2 FY 24-25



This presentation and the accompanying slides (the “Presentation”), have been prepared by Jamna Auto Industries Limited (the “Company”), have been prepared solely for information purposes and do not constitute any offer, recommendation or invitation to purchase or subscribe for any securities, and shall not form the basis or be relied on in connection with any contract or binding commitment whatsoever. No offering of securities of the Company will be made except by means of a statutory offering document containing detailed information about the Company.

This Presentation has been prepared by the Company based on information and data which the Company considers reliable, but the Company makes no representation or warranty, express or implied, whatsoever, and no reliance shall be placed on, the truth, accuracy, completeness, fairness and reasonableness of the contents of this Presentation. This Presentation may not be all inclusive and may not contain all of the information that you may consider material. Any liability in respect of the contents of, or any omission from, this Presentation is expressly excluded.

Certain matters discussed in this Presentation may contain statements regarding the Company’s market opportunity and business prospects that are individually and collectively forward-looking statements. Such forward-looking statements are not guarantees of future performance and are subject to known and unknown risks, uncertainties and assumptions that are difficult to predict. These risks and uncertainties include, but are not limited to, the performance of the Indian economy and of the economies of various international markets, the performance of the industry in India and world-wide, competition, the company’s ability to successfully implement its strategy, the Company’s future levels of growth and expansion, technological implementation, changes and advancements, changes in revenue, income or cash flows, the Company’s market preferences and its exposure to market risks, as well as other risks. The Company’s actual results, levels of activity, performance or achievements could differ materially and adversely from results expressed in or implied by this Presentation. The Company assumes no obligation to update any forward-looking information contained in this Presentation. Any forward-looking statements and projections made by third parties included in this Presentation are not adopted by the Company and the Company is not responsible for such third party statements and projections.

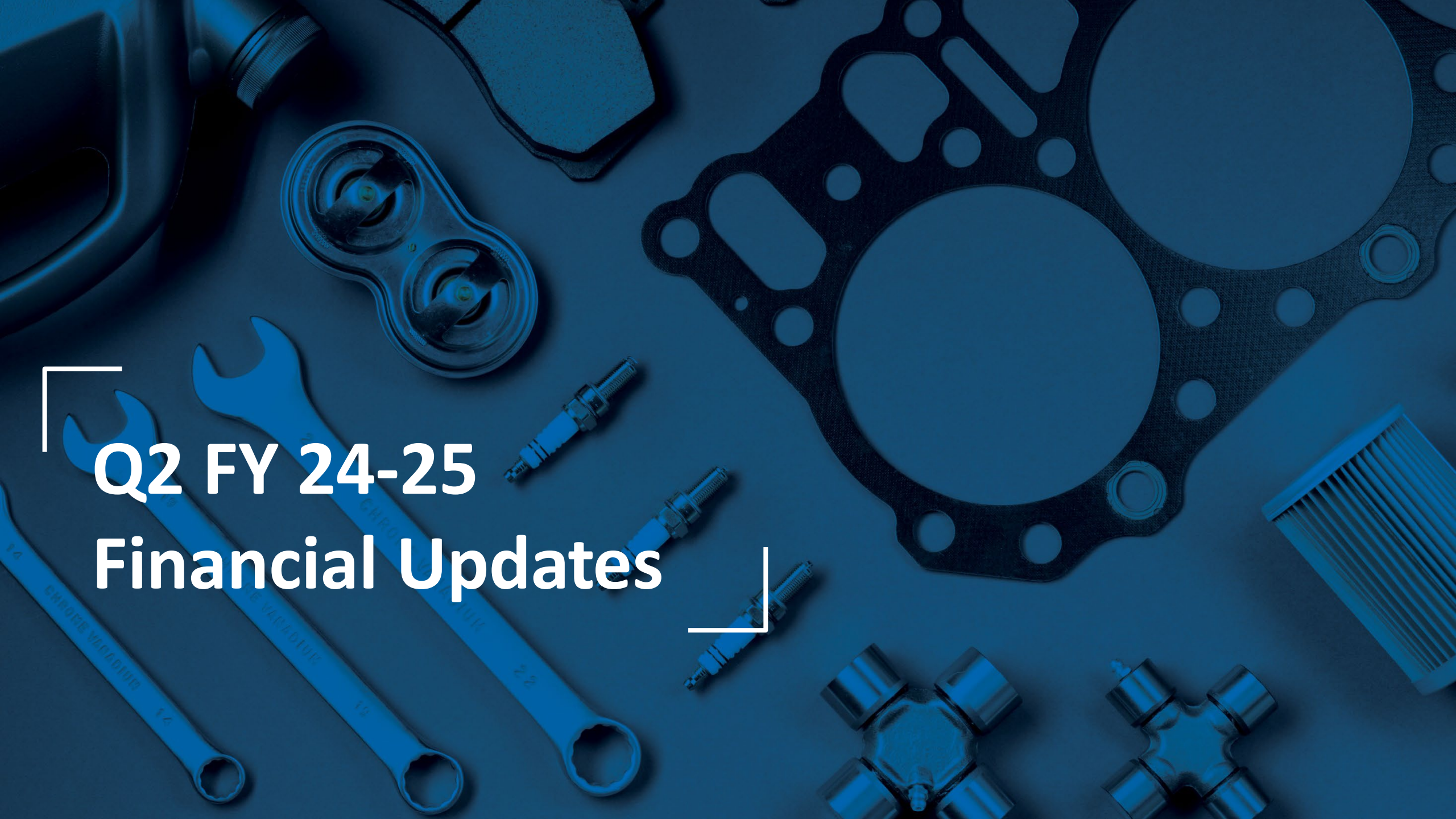

Q2 FY 24-25
Financial Updates

Financial Trends - QoQ



All figures are in INR crores

	Q2 FY 24-25	Q1 FY 24-25	Q2 FY 23-24
NET SALES	513	557	607
EBITDA	67/13.1%	76/13.7%	81/13.3%
PBT	56/10.9%	65/11.6%	69/11.3%
CASH ACCRUALS	51	57	61

Cash Accruals: PAT+ Depreciation

Financial Trends - YoY



All figures are in INR crores

	H1 FY 24-25	H1 FY 23-24	FY 23-24
NET SALES	1,069	1,183	2,427
EBITDA	143/13.4%	155/13.1%	331/13.7%
PBT	120/11.2%	132/11.1%	283/11.7%
CASH ACCRUALS	108	118	250

Cash Accruals: PAT+ Depreciation

Profit & Loss Statement

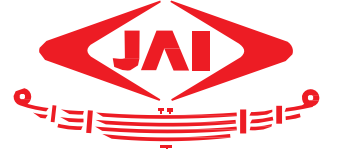

Consolidated QoQ

All figures are in INR crores

Particulars	Q2 FY 24-25	Q2 FY 23-24	YoY	Q1 FY 24-25	QoQ
Net Sales	513	607	-16%	557	-8%
EBITDA	67	80	-17%	76	-12%
PBT	56	69	-19%	65	-14%
PAT	40	50	-21%	46	-14%

Profit & Loss Statement



Consolidated YoY

All figures are in INR crores

Particulars	H1 FY 24-25	H1 FY 23-24	YoY	12 Months FY 23-24
Net Sales	1,069	1183	-10%	2427
EBITDA	143	155	-7%	331
PBT	120	131	-9%	283
PAT	86	96	-10%	205

Revenue Mix



Product Mix

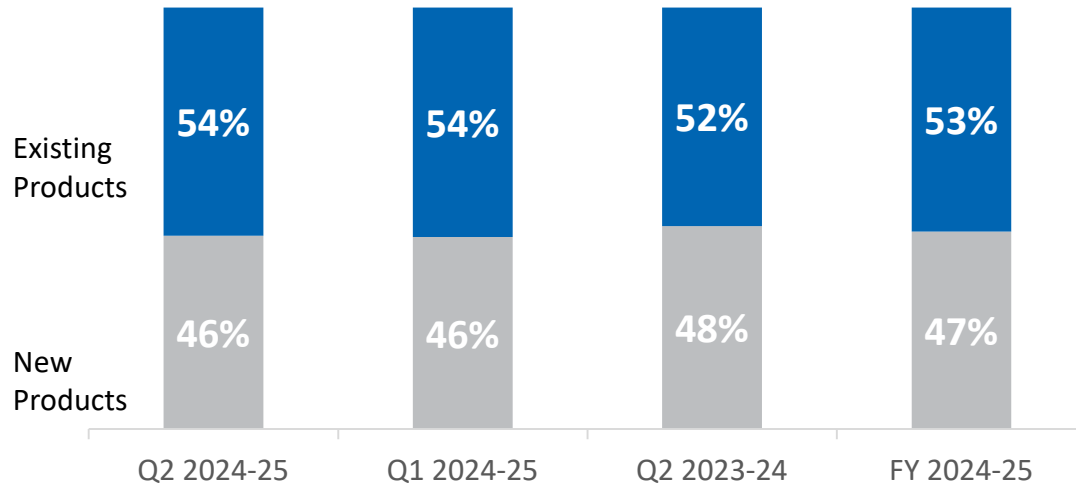

Lakshya Target: **50%** revenue from New Products by FY 2026-27

Market Mix

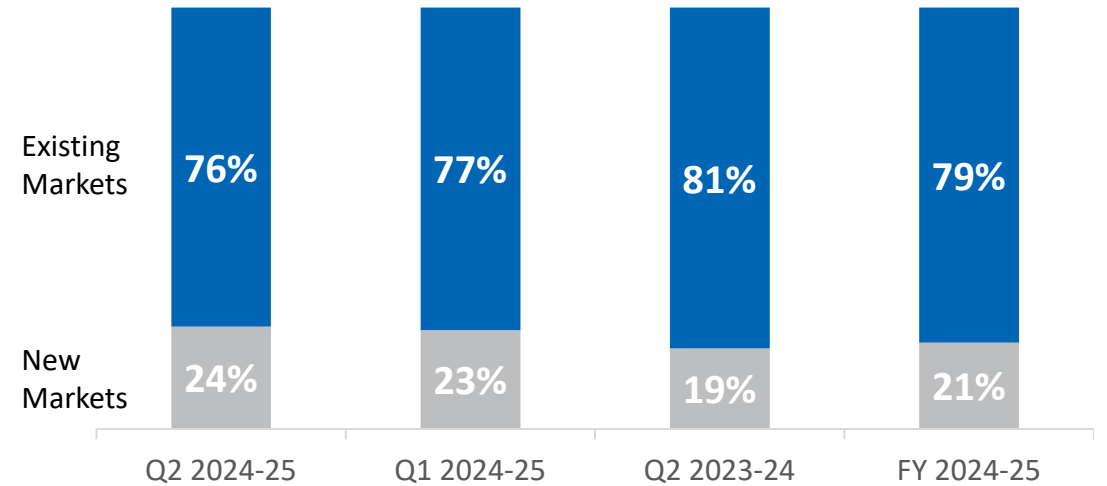

Lakshya Target: **50%** revenue from New Markets by FY 2026-27



Industry Highlights

Industry Highlights



All figures are in '000

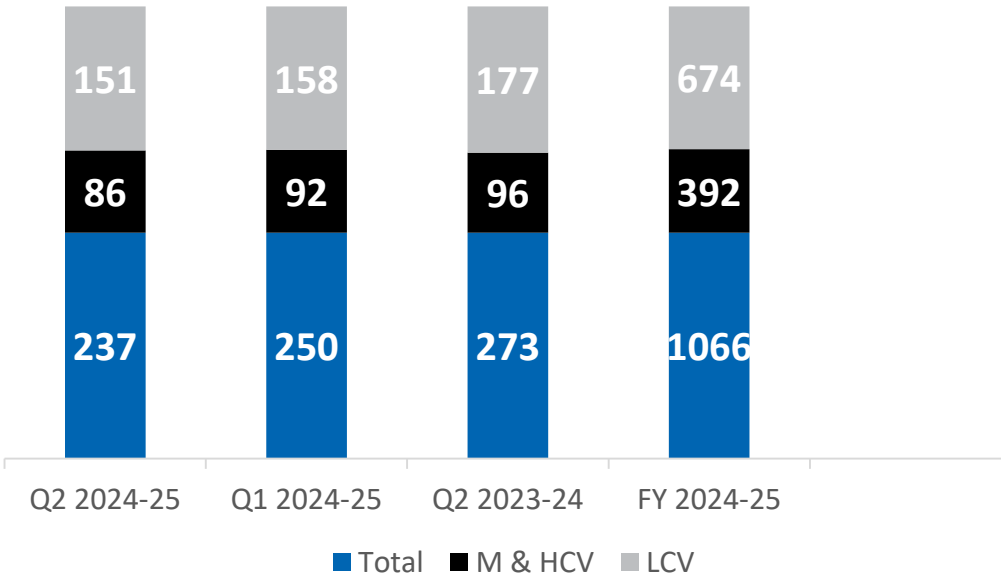

Data Source-SIAM

LCV production changes

- ↓ - Q2 FY25 vs Q1 FY25 - 5% (Decrease)
- ↓ - Q2 FY25 vs Q2 FY24 - 15% (Decrease)

M&HCV production changes

- ↓ - Q2 FY25 vs Q1 FY25 - 6% (Decrease)
- ↓ - Q2 FY25 vs Q2 FY24 - 11% (Decrease)

For the Quarter

QoQ Change %	YoY Change %
- 5%	-15%
-6%	-11%
-5%	-13%





Company Overview

JAI at a Glance





 **Foundation**
JAI is a renowned suspension manufacturer for commercial vehicles.

 **World class Manufacturing Infrastructure**
10 Manufacturing units including 1 In-house R&D center

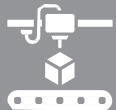

- More than 16,000 touch points
- JAI Shoppe in Sanjay Gandhi Transport Nagar, Delhi which is one of the largest trucking center in India.

 **Manufacturing**
~300+ OEM parts
~5,000+ AMI parts

 **Sound Financials**
CRISIL A1+/AA-

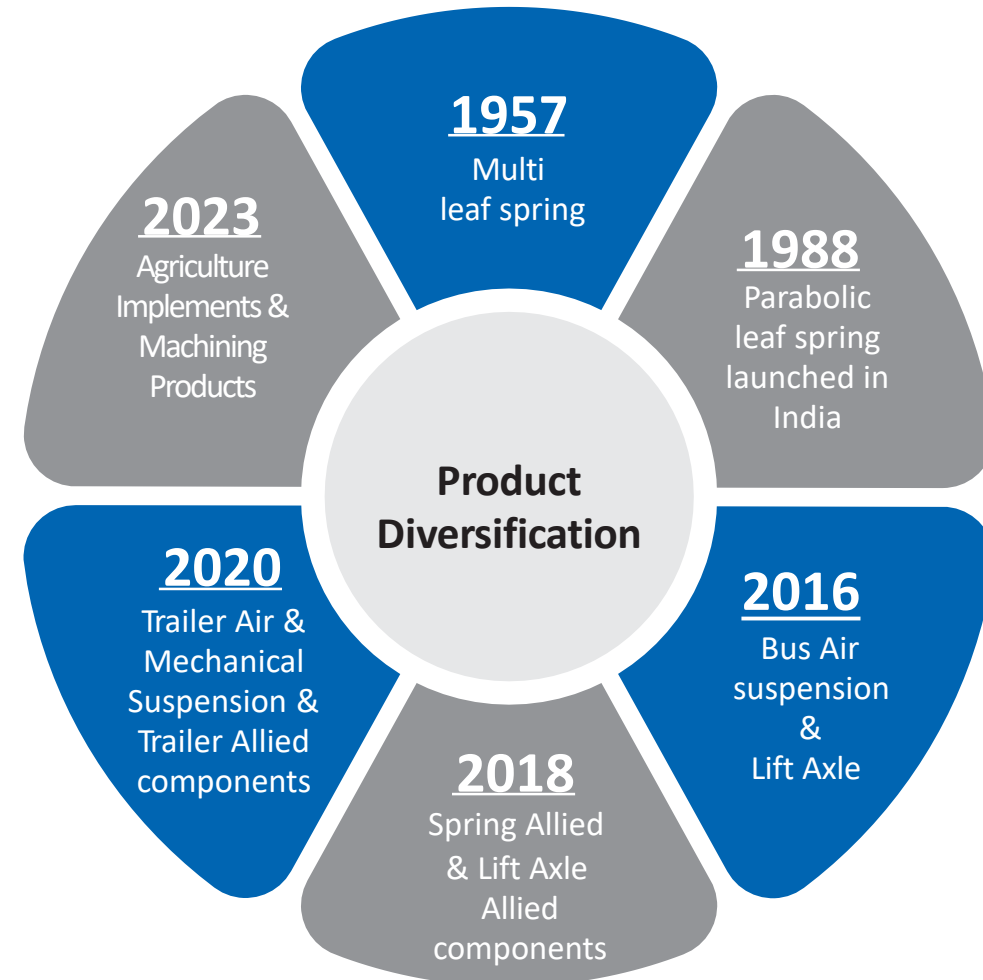

Jai's Plants : Strategically Located Across OEM Plants

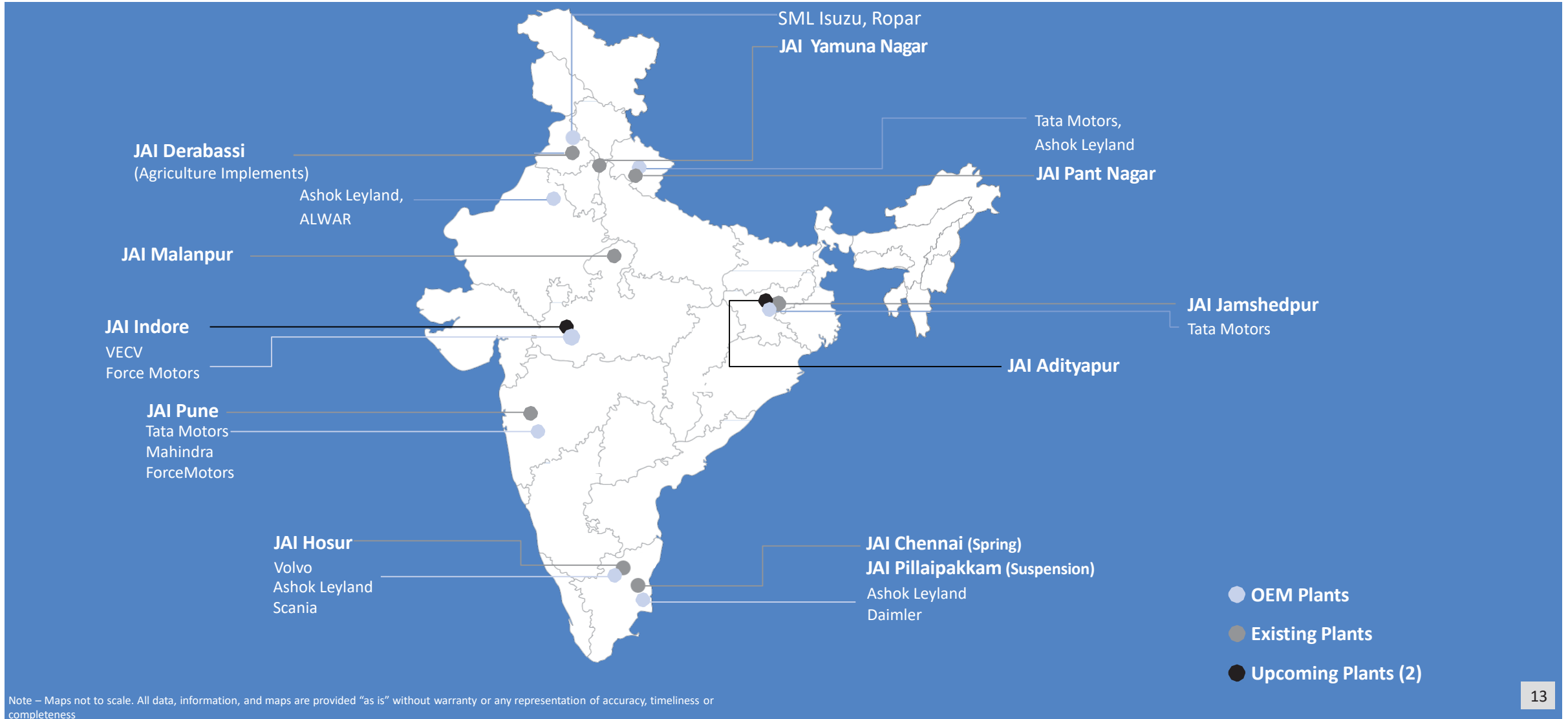

Note – Maps not to scale. All data, information, and maps are provided “as is” without warranty or any representation of accuracy, timeliness or completeness

Strength and Key Focus Areas

Strength

- Manufacturing footprint with logistics benefit.
- Low BEP with Low Leveraged.
- Spare capacity to capture unprecedented demand from all Markets.
- Wide After Market Network
300+ Distributors,
11500+Retailers,
15000+ Mechanics.



Key Focus Areas

- New Markets (AMI, AME).
- New Products (Trailer, CPV in CV).

JAI's OEM Customers



JAI's Product Portfolio

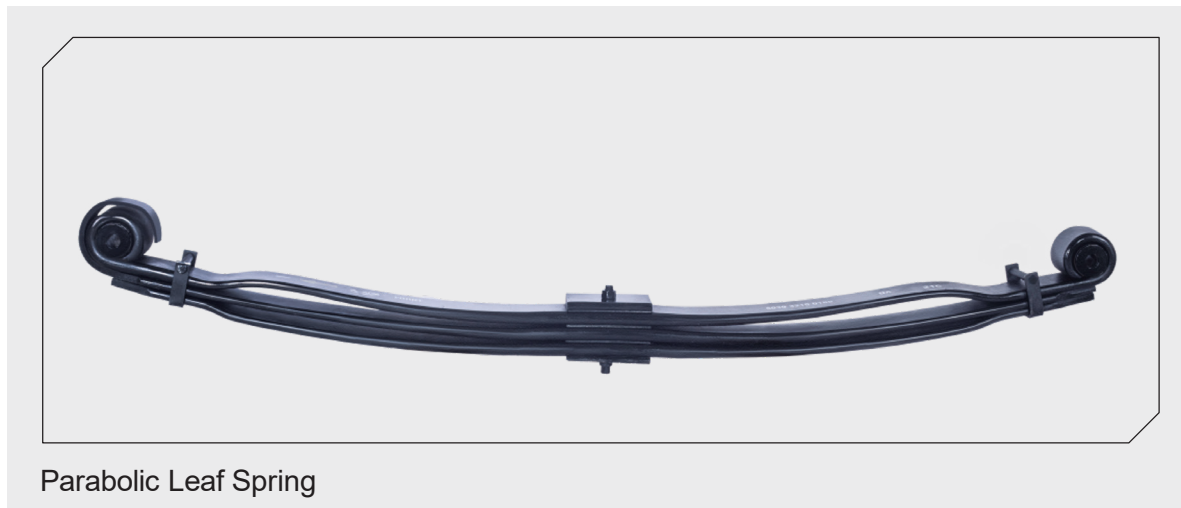
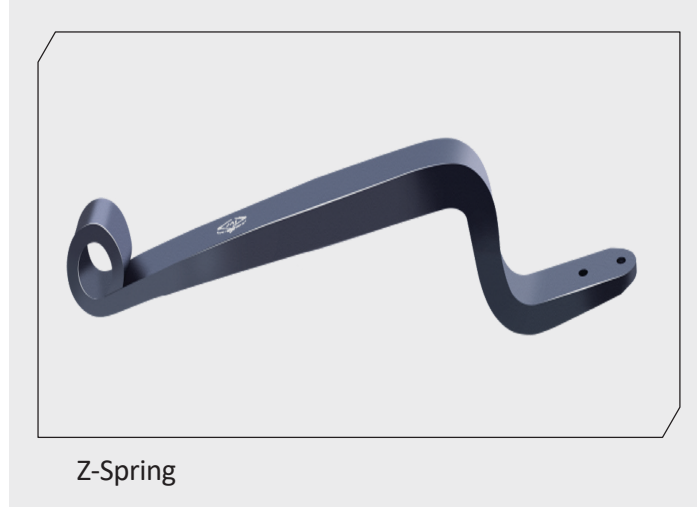

JAI's Product Portfolio

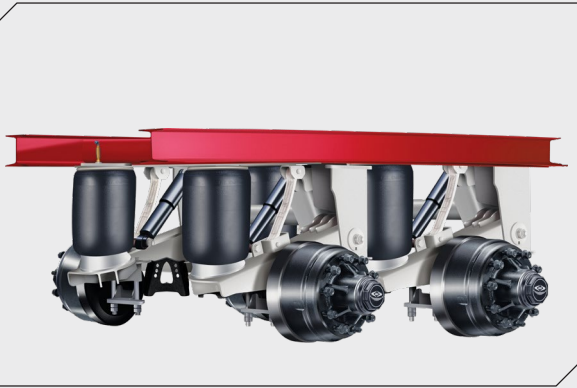

Bus Air Suspension

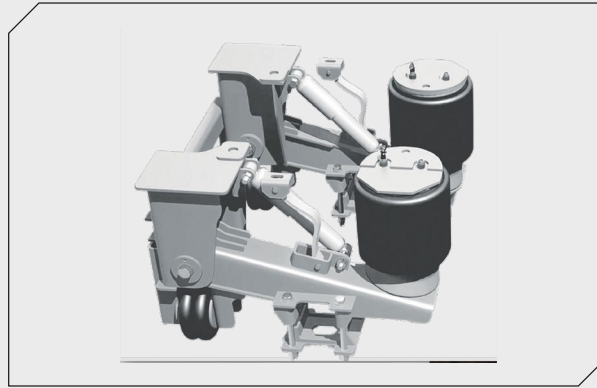

Trailer Air Suspension



Lift Axle

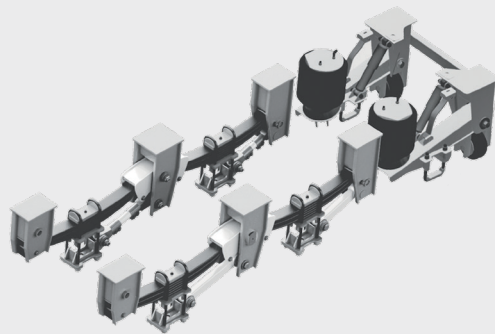

Trailer Mechanical and Air Suspension with Lift Axle

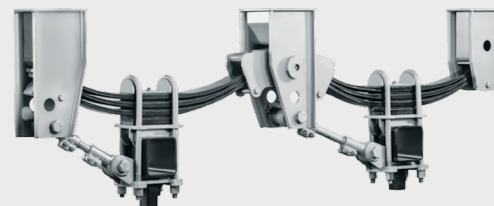

Trailer Mechanical Suspension

JAI's Product Portfolio



Agriculture Implements



Fertilizer Broadcaster



Fertilizer Broadcaster



Laser Land Leveller



Rotavator

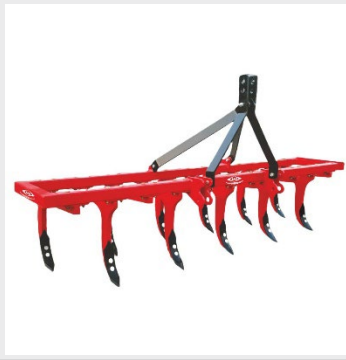

Cultivator

After Market India JAI's Product Portfolio

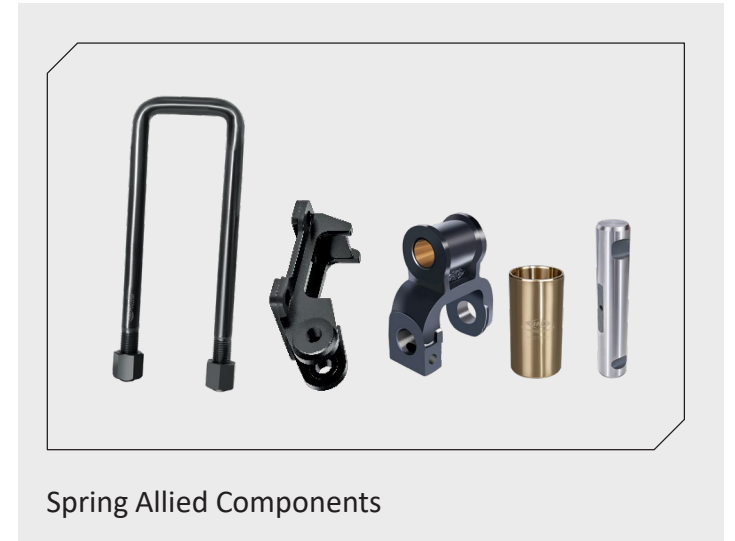
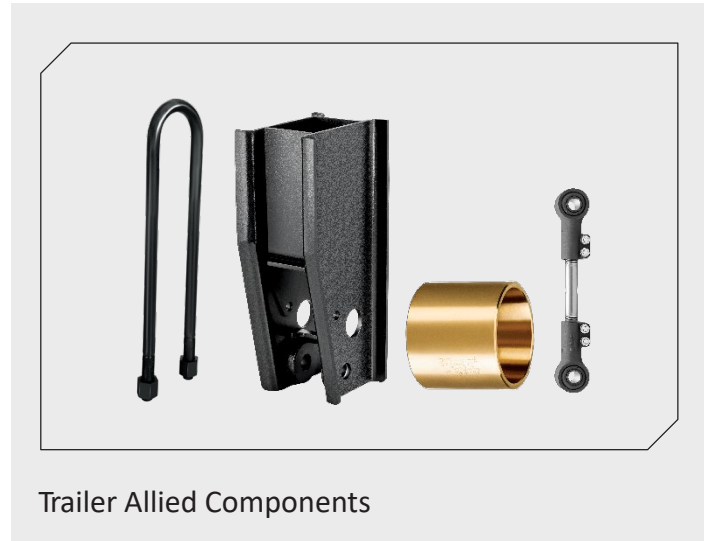
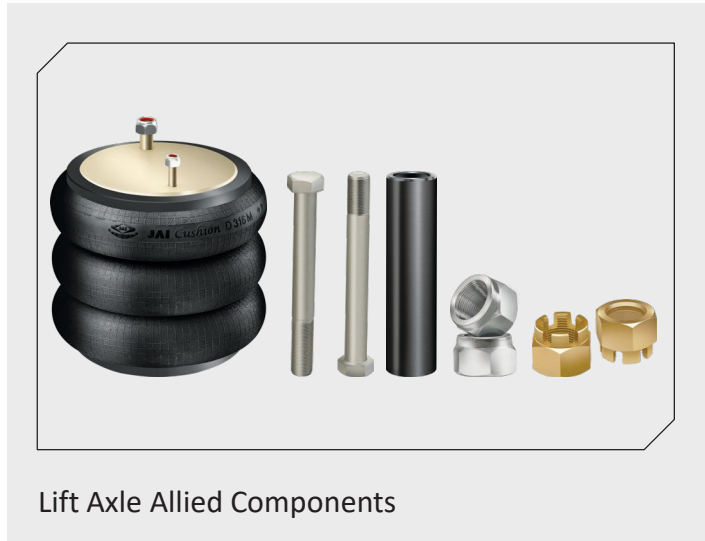

After Market India JAI's Product Portfolio



Brake lining

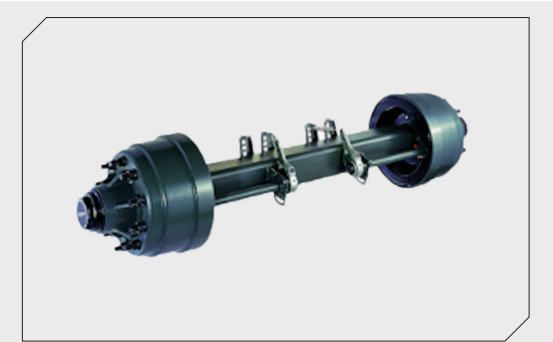

Trailer Axle



Water Pump



Clutch

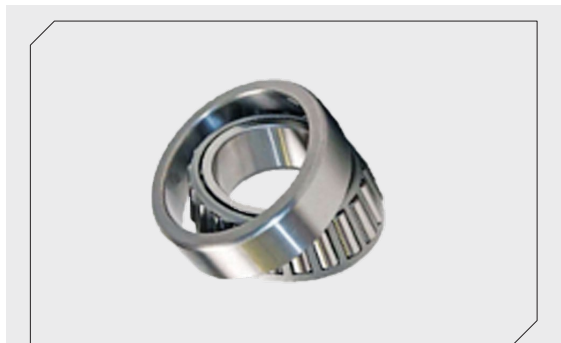

Bearing

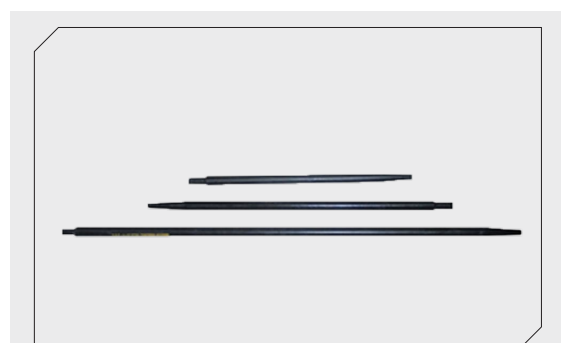

Jack Rod

Most of the products above are only traded

Jamna Auto Industries Limited ('JAI')

Shareholding Pattern as on 30th Sep 2024

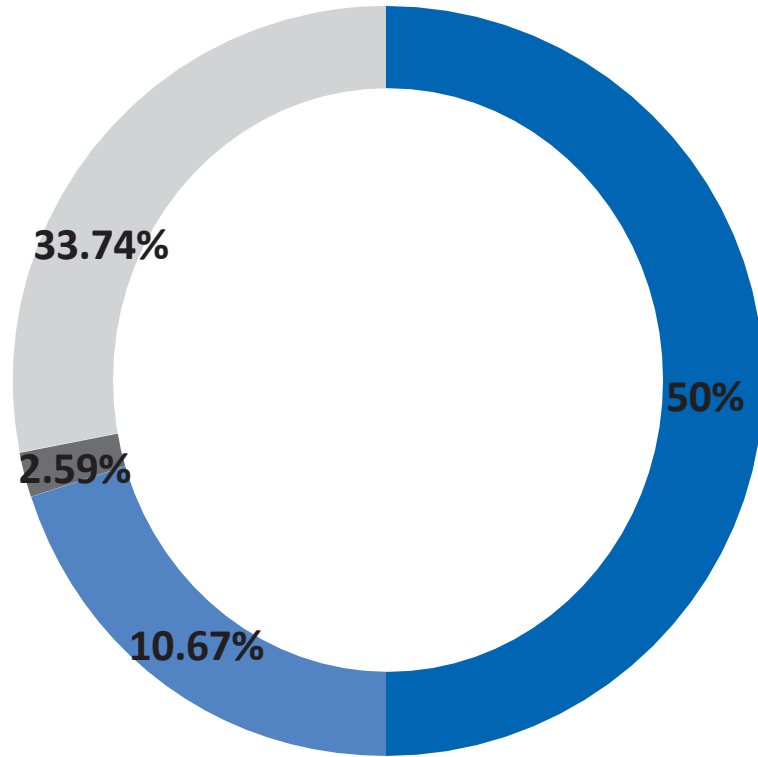

- Promoters
- Institutional investors

Categories	% Holding as on 30.9.2024	% Holding as on 31.3.2024
Promoters	50%	50%
Institutional Investors	10.67 %	14.81%
Bodies Corporate	2.59%	1.75%
Individual & Others	33.74%	33.44%
Total	100%	100%

Contributing to the Society



We are committed to contribute to the social and economic welfare of communities in which we operate. Playing an active role in sustaining positive change within society, we aim to create opportunities for the holistic development of people from all sections of society.



Handing over tree guards to District Prison, Gurgaon



Awarding meritorious students in Govt. School, Pillaipakkam



Jai Sponsored Shooter placed 1st position in 175th India Open Shotgun Event in Patiala



Provided Nutrition kit to anemic pregnant women in Chennai



Contributing to the Society



Environment

- Planted 5235 saplings during rainy season in all locations.
- Prepared, thrown in forest and distributed 50,000 seed balls to Govt. offices, community, schools, truck drivers and others.
- Developed 250 meter green belt in Pant Nagar, Uttarakhand.
- Installed 200 tree guards to district prison Gurugram & District Sports complex, Yamuna Nagar to protect and maintain green cover.
- Conserved around 1.5 crore liters rain water in ponds and RWH pits.
- Produced 18000 kg shivansh manure and 600 kg vermin-compost in Delhi, YNR & Jamshedpur.



Education

- Provided study material & furniture to 10 Govt. schools in Yamuna Nagar & Chennai.
- Renovated 5 girls toilets, constructed 01 hand wash station in Govt. schools YNR & Chennai.
- Distributed quarterly dental kits (2150) to all students in Govt. primary schools in YNR, Jamshedpur & Pillaipakkam.
- Distributed stationary items & school bags to 175 Govt. school students in Chennai.
- Total 95 youths & prison inmates were completed their respective computer course in Jamna Computer Training Centers in Delhi, Gurgaon & Jamshedpur.
- Total 68 women including prison inmates were trained in beautician course in Yamuna Nagar & District Prison, Panipat.



Sports

- Sponsored monthly diet to 15 sportspersons in YNR, Mohali and Jamshedpur.
- Awarded one time sponsorship to International shotgun shooter, Mr. Abhay Singh.
- Celebrated National Sports Day by conducted sports events in Govt. schools and SDC in Delhi, Pillaipakkam, Jamshedpur and Chennai.
- Our archery player Ms. Priti Razwar from Jamna Archery Academy has been selected for under-14 state level archery competition, Jharkhand.
- Our sponsored shotgun shooter Mr. Abahy Singh placed 1st position in 175th India Open Shotgun Event in Patiala

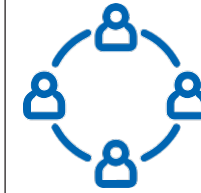

Community Reach

- 60 nutrition kits were distributed to needy anemic pregnant women in Chennai.
- 50 nutrition kits were distributed to needy TB patients for speedy recovery.
- Organized 02 multispecialty health camps in nearby villages in which 284 patients were screened and got medicine in Malanpur, MP.
- **Served food to more than 450 migrant labor and orphan children every month in YNR.**
- **50 wheelchairs were provided to Haryana CSR Trust for physically disabled voters in state elections.**
- An electric tricycle provided to a needy physically disabled person in Naraingarh, Haryana.
- Donated musical instrument to Aarohan Welfare society for musical therapy for PwD's & children with special needs in Yamuna Nagar.
- Distributed monthly pension to 124 sr. citizens, widow and PwD's in Yamuna Nagar.





Thank You
