

Registered Office
"Maithri"
132, Cathedral Road,
Chennai 600 086, India.
CIN: L63011TN2004PLC054948

Tel: 91 44 2811 2472
URL: www.ranegroup.com

Rane Brake Lining Limited



// Online submission //

RBL / SE / 035 / 2022-23

October 31, 2022

BSE Limited Listing Centre Scrip Code: 532987	National Stock Exchange of India Ltd. NEAPS Symbol: RBL
--	--

Dear Sir / Madam,

Sub: Earnings Presentation - Un-Audited Financial Results for the half year ended September 30, 2022

Ref: Our letter no(s). RBL/SE/033/2022-23 dated October 26, 2022 and RBL/SE/034/2022-23 dated October 27, 2022

This is with reference to the aforementioned letters intimating Earnings Conference Call scheduled on **Monday, October 31, 2022 at 14:00 hours (IST)**, inter alia, to discuss the un-audited financial results for the half year ended September 30, 2022. We enclose herewith copy of the Earnings presentation proposed to be made thereat, to the analyst and investors.

The same is also being made available on the website of the Company, www.ranegroup.com.

We request you to take the above on record and note the compliance with SEBI (Listing Obligations and Disclosure Requirements) Regulations, 2015 (SEBI LODR).

Thanking you,

Yours faithfully,

For **Rane Brake Lining Limited**

Venkatraman
Secretary

Encl: a/a

Rane Group

Earnings Presentation | H1 FY23

Table of Contents

H1 FY23 Financial & Operational Performance

Rane Group Overview



Rane Group

H1FY23 Financial & Operational Performance



To become the Preferred Trusted Supplier of Safety & Critical Auto Components

Strategic pillars of growth

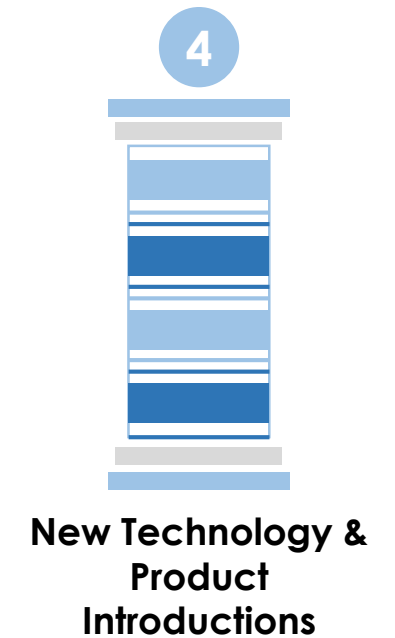
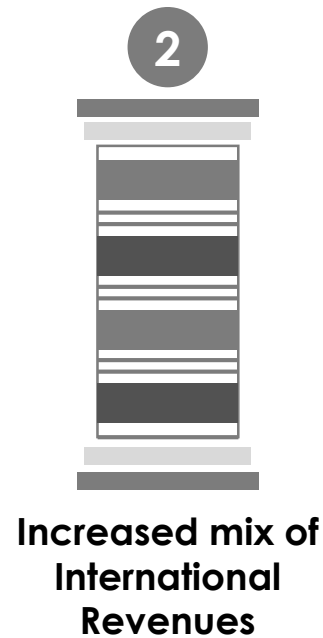

Business Drivers

- › **93%+ of revenue comes from powertrain agnostic products**
- › **Continued dominance on domestic market across major products**
- › **Increasing export mix for steering & linkages, valve train components and occupant safety products**
- › **Renewed focus on Aftermarket segment leveraging group level synergy**
- › **Continuous introduction of new product and new technology leveraging global partnerships and strong in-house engineering capabilities**
- › **Increasing efficiencies across manufacturing facilities through operational excellence, digitalisation, etc.**

RANE BRAKE LINING

- Won orders worth Rs. 35 Cr from various customers

RANE ENGINE VALVE

- Won orders worth Rs. 10 Cr from various customers

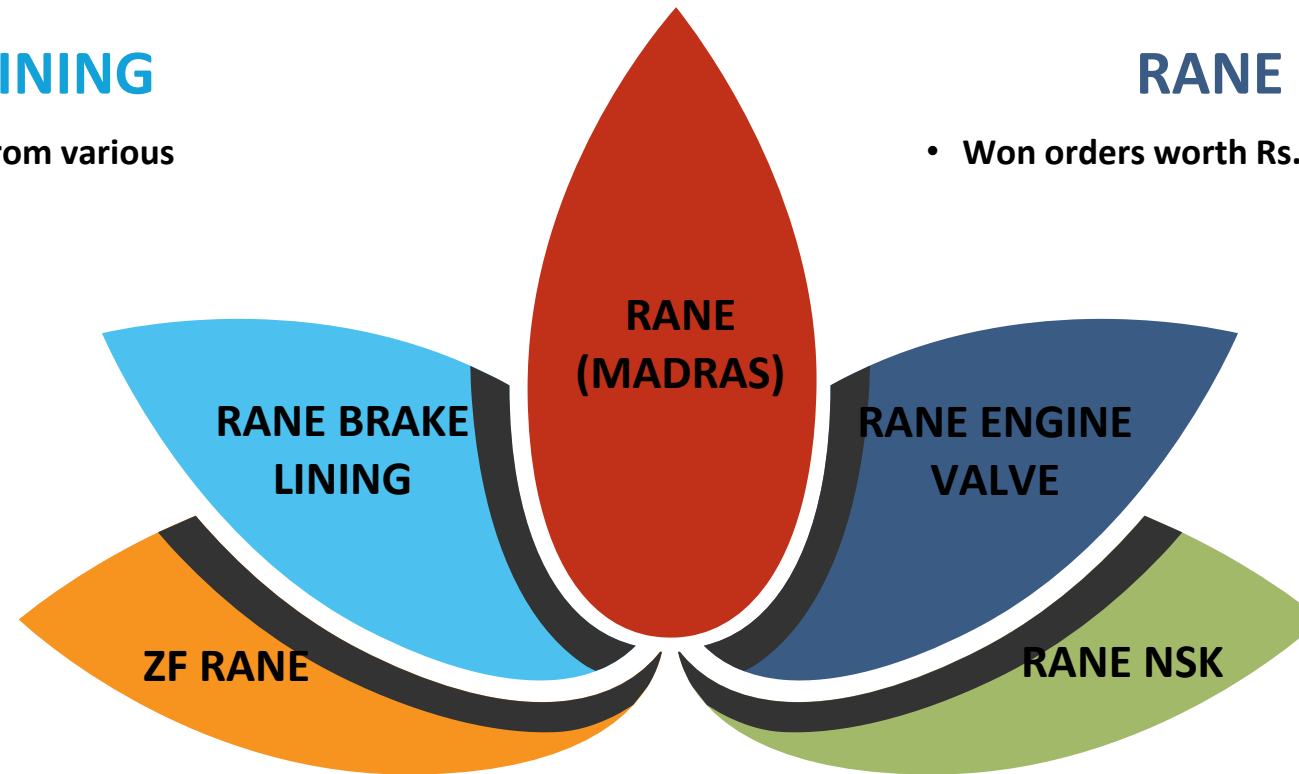

ZF RANE

- Won orders worth Rs. 240 Cr for Occupant safety products
- Won orders worth Rs. 155 Cr for Steering gear products





RANE (MADRAS)

- Won Rs. 105 Cr orders from various domestic and international customers for Steering products

RANE NSK

- Won new business worth Rs. 75 Cr for Manual Steering Column from various customers

We continue to target higher than the industry growth

Industry Performance Review (H1 FY23)	 Passenger Vehicle	 Commercial Vehicle	 Farm Tractor	 2-Wheeler
	36%	56%	5%	20%
Rane Group Sales Growth YoY in % (India OEM)	34%	71%	15%	34%
	61%	26%	7%	3%
	<ul style="list-style-type: none"> Lower growth than the industry due to lower growth of few served models 	<ul style="list-style-type: none"> Higher share of business and higher growth with served models/customers 	<ul style="list-style-type: none"> Performance is better than industry due to increase in power steering penetration 	<ul style="list-style-type: none"> Better performance is driven by higher offtake of valve train products

Market Commentary

- Easing of semiconductor shortage drives demand from Indian PV customers
- Experiencing demand up-cycle in the CV segment
- Seasonally low quarter for Farm Tractor segment
- Demand for our products remained favourable in international markets albeit growing signs of slowdown due to geo political issues and monetary tightening
- Seeing plateauing of commodity prices and expect some softening in the coming quarters

Group Aggregate Sales (H1 FY23)

Total Revenue (Rs cr.)

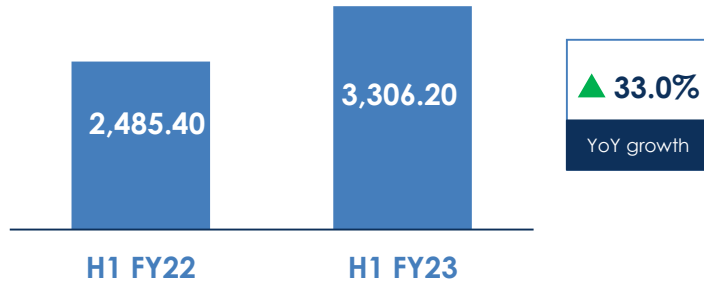

› Total Revenue increased by 33% from Rs. 2,485.4 Cr in H1 FY22 to Rs. 3,306.2 Cr in H1 FY23

- Revenue from Indian OE customers grew 36% supported by strong growth across vehicle segments
- Revenues from International customers increased 25% driven by higher off-take across products
- Revenue from Indian aftermarket segment grew 31%

Group Aggregate Sales (H1 FY23)

BY PRODUCT (%)

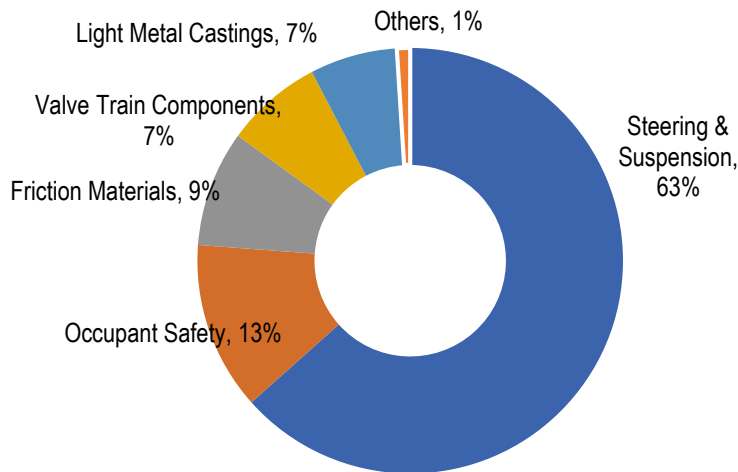

BY MARKET (%)

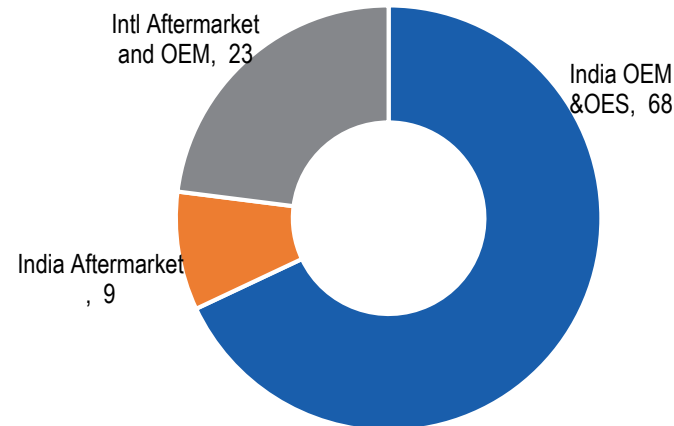

BY VEHICLE SEGMENT (%)

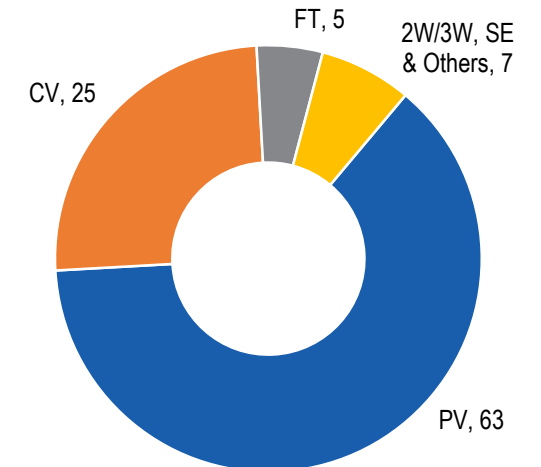

Total Revenue (Rs cr.)

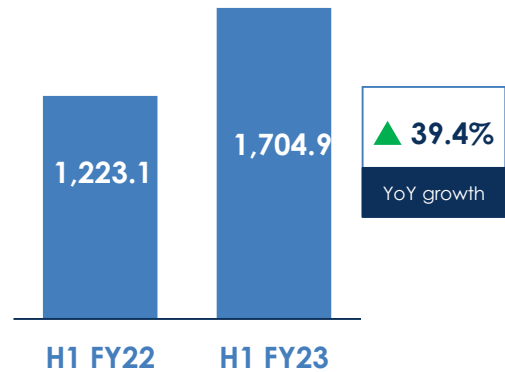

EBITDA (Rs cr.)

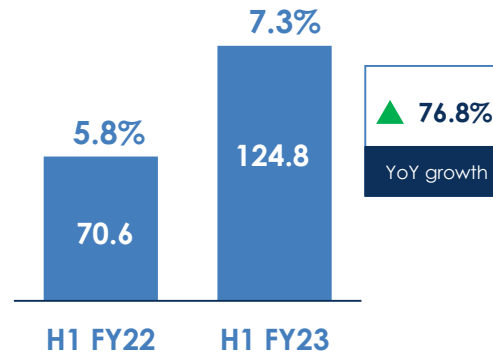

PAT (Rs cr.)

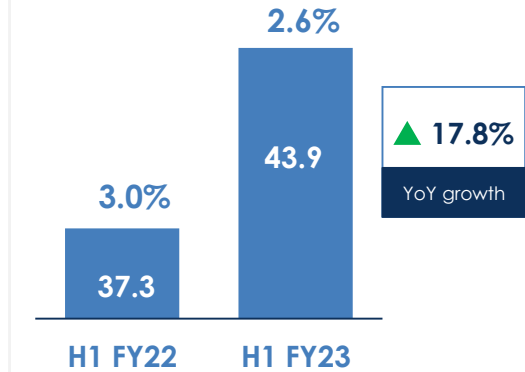

› **Total Revenue increased by 39.4% from Rs. 1,223.1 Cr in H1 FY22 to Rs. 1,704.9 Cr in H1 FY23**

› **EBITDA increased by 76.8% from Rs. 70.6 Cr in H1 FY22 to Rs. 124.8 Cr in H1 FY23**

– EBITDA margin increased 155 bps supported by higher volumes and improved operational performance. Higher commodity prices limited the profitability improvement.

› **PAT increased by 17.8% from Rs. 37.3 Cr in H1 FY22 to Rs. 43.9 Cr in H1 FY23**



Rane (Madras) Limited

H1FY23 Financial & Operational Performance



Business Drivers

- › Strong order book pipeline for Steering and Linkages products
- › Financial turnaround of Light Metal Castings India business with increasing capacity utilization and operational improvements
- › Aftermarket segment primed to grow aggressively with new product introductions

Operational Highlights

- › Certified as a 'Great Work place' by GPTW Institute, India – for 5th consecutive year
- › Won the runner up award in Ashok Leyland's National Supplier Samrat competition in the Proprietary category
- › Received award from Tata Motors, Pantnagar for “Energy champion of the year 2021-22”
- › Light Metal Castings India received an Award from Bosch for their performance in the export of Steering Housing Castings
- › LMCA has won the award for Excellence in Aluminum Die Casting in the category of 1-10 Lbs from the North American Die Casting Association (NADCA)

Business Split (H1 FY23) – RML India

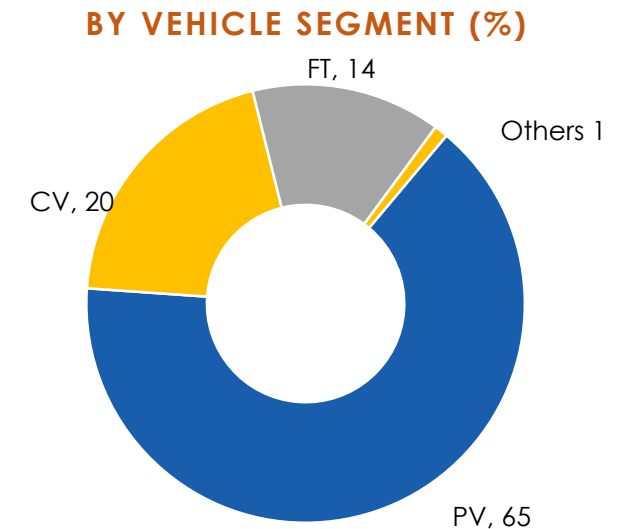
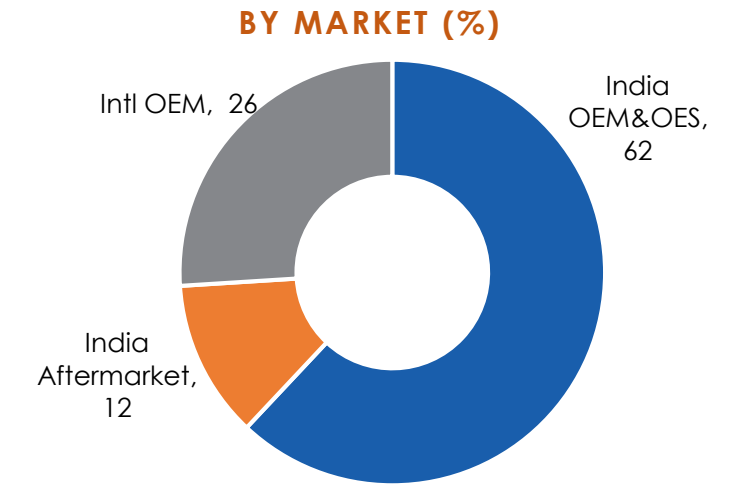

Total Revenue (Rs cr.)

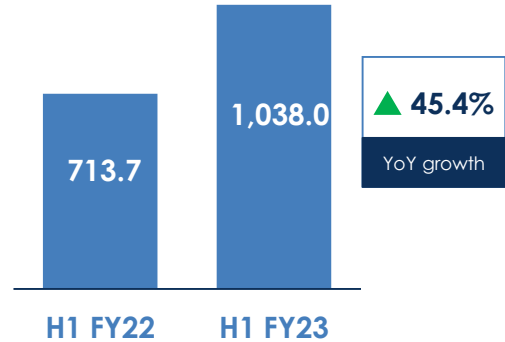

EBITDA (Rs cr.)

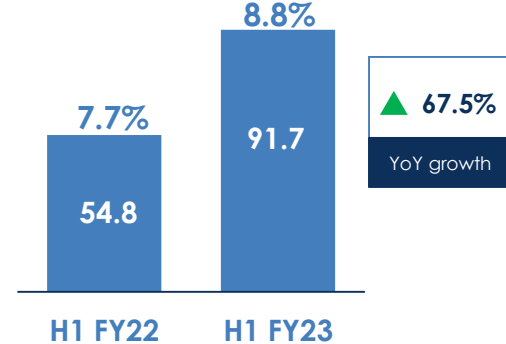

PAT (Rs cr.)

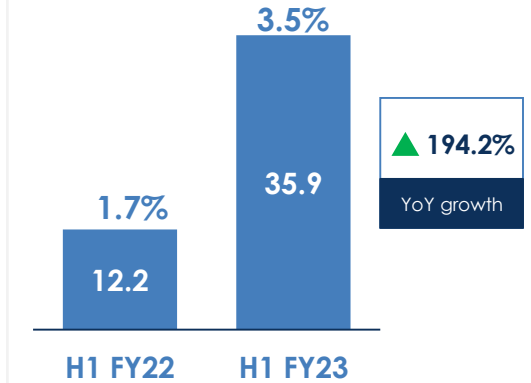

› **Total Revenue increased by 45.4% from Rs. 713.7 Cr in H1 FY22 to Rs. 1,038.0 Cr in H1 FY23**

- Sales to Indian OE customers grew 60% supported by strong demand across vehicle segments.
- Sales to International customers grew 27%. Demand from International customers remained strong.
- Sales to Indian Aftermarket customers grew 25%.

› **EBITDA increased by 67.5% from Rs. 54.8 Cr in H1 FY22 to Rs. 91.7 Cr in H1 FY23**

- EBITDA margin increased by 116 bps supported by higher volumes and improved operational performance

› **PBT increased by 194.2% from Rs. 12.2 Cr in H1 FY22 to Rs. 35.9 Cr in H1 FY23**

Total Revenue (Rs cr.)

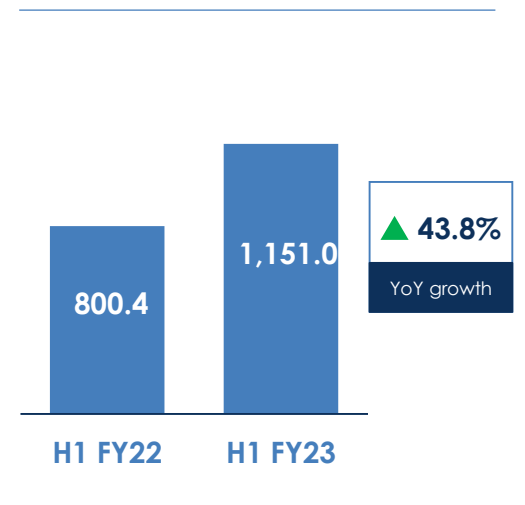

EBITDA (Rs cr.)

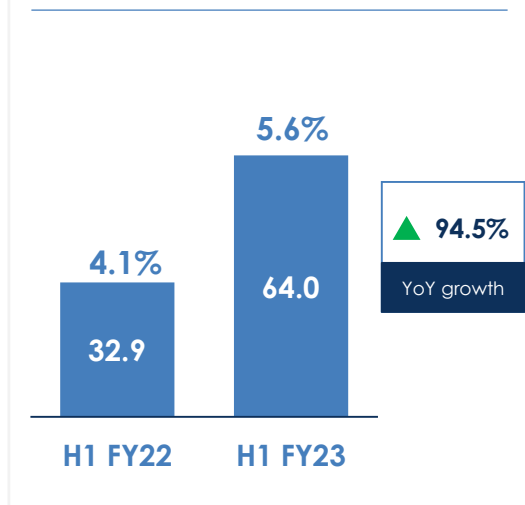

PAT (Rs cr.)

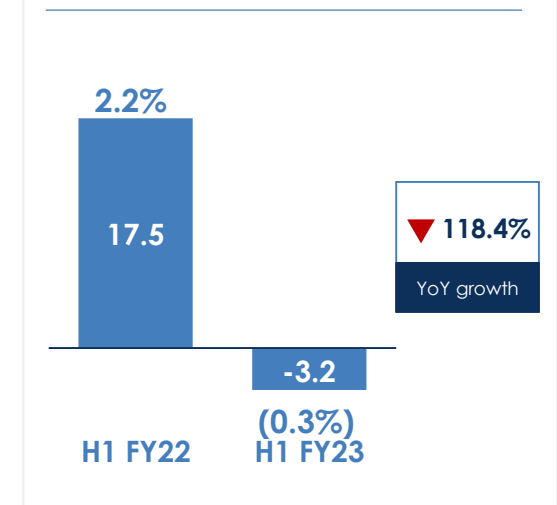

› **Total Revenue increased by 43.8% from Rs. 800.4 Cr in H1 FY22 to Rs. 1,151.0 Cr in H1 FY23**

– Sales of the US subsidiary grew with the improved off-take from customers. However the demand environment in the US remains challenging

› **EBITDA increased by 94.5% from Rs. 32.9 Cr in H1 FY22 to Rs. 64.0 Cr in H1 FY23**

– Better operational performance and higher volumes helped improve profitability

› **PAT declined by 118.4% from Rs. 17.5 Cr in H1 FY22 to Rs. (3.2) Cr in H1 FY23**

– There was a one-off income of USD 5 Mn on account of US Federal stimulus benefits in H1 FY22.



Rane Engine Valve Limited

H1FY23 Financial & Operational Performance



Business Drivers

- › 44% of revenue generated from EV insulated segment
- › Financial turnaround underpins
 - › Higher capacity realization and new business ramp up
 - › Increasing mix of exports and EV insulated segment
 - › Manufacturing cost reduction

Operational Highlights

- › Certified as a 'Great Work place' by GPTW Institute, India
- › Ramp up in hollow valve production

Business Split (H1 FY23)

BY MARKET (%)

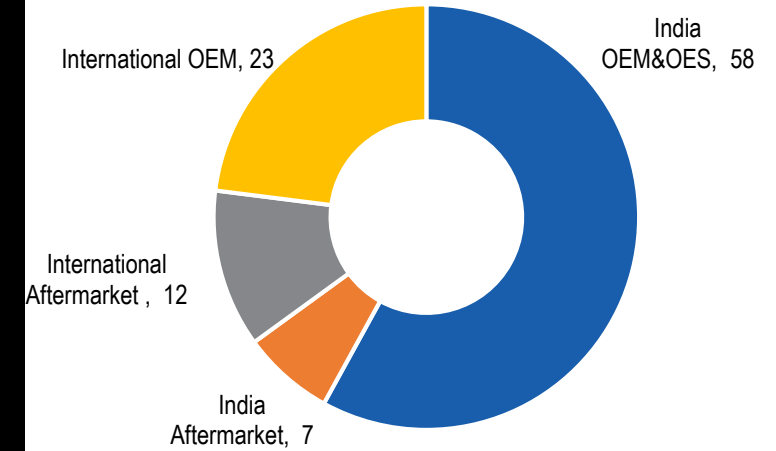

BY VEHICLE SEGMENT (%)

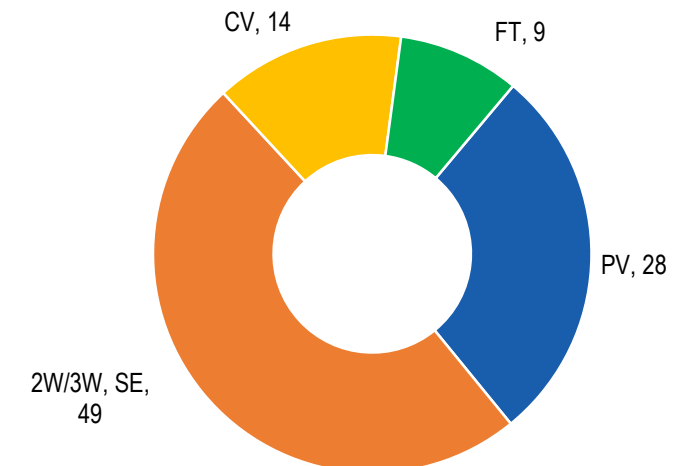

Total Revenue (Rs cr.)

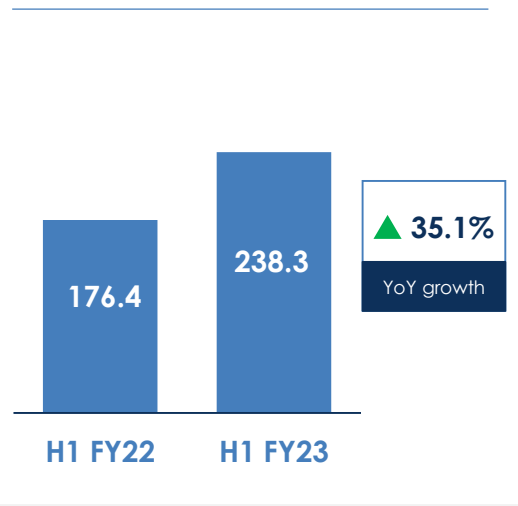

EBITDA (Rs cr.)

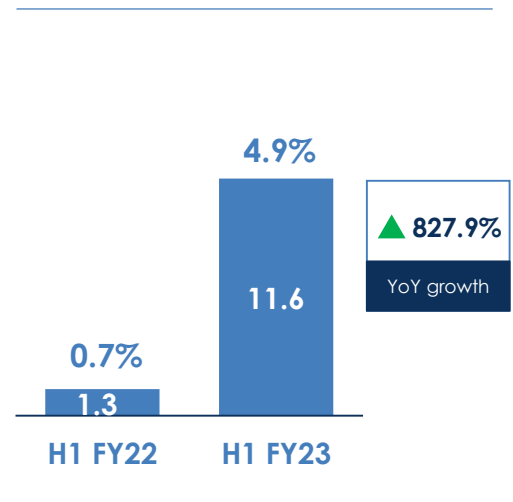

PAT (Rs cr.)

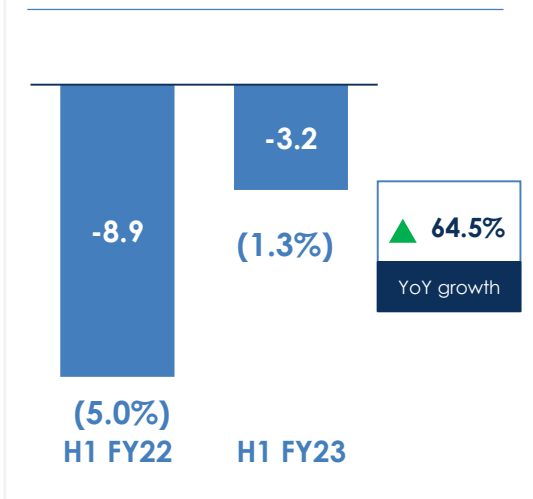

› **Total Revenue increased by 51.3% from Rs. 176.4 Cr in H1 FY22 to Rs. 238.3 Cr in H1 FY23**

- Sales to Indian OE customers grew 50% supported by strong demand across vehicle segments.
- Export Sales grew 55%. Demand from International customers remained strong.
- Sales to Indian Aftermarket customers grew 46%.

› **EBITDA increased by 827.9% from Rs. 1.3 Cr in H1 FY22 to Rs. 11.6 Cr in H1 FY23**

- EBITDA margin improved by 417 bps due to improved operational performance, price recovery from customers and operational leverage on higher volume.

› **Loss reduced by 64.5% from Rs. (8.9) Cr in H1 FY22 to Rs. (3.2) Cr in H1 FY23**



Rane Brake Lining Limited

H1FY23 Financial & Operational Performance



Business Drivers

- › Market leader in Passenger Vehicle segment and increased penetration in two wheeler segment
- › Dominant presence in Aftermarket segment, which accounts for 35% of sales
- › Expanding International Aftermarket business
- › Robust operational performance

Operational Highlights

- › Won Best Supplier Award in Friction category from Brakes India Pvt. Ltd.
- › Won 1st prize in National level QC Convention conducted by ACMA.
- › Certified as a 'Great Work place' by GPTW Institute, India – for 6th consecutive year

Business Split (H1 FY23)

BY MARKET (%)

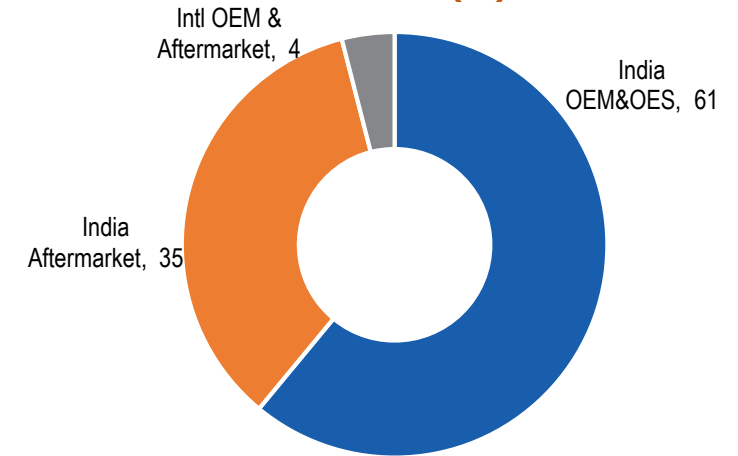

BY VEHICLE SEGMENT (%)

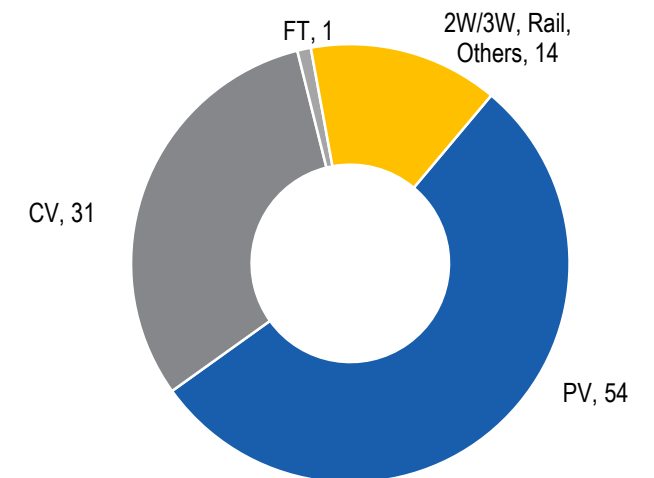

Total Revenue (Rs cr.)

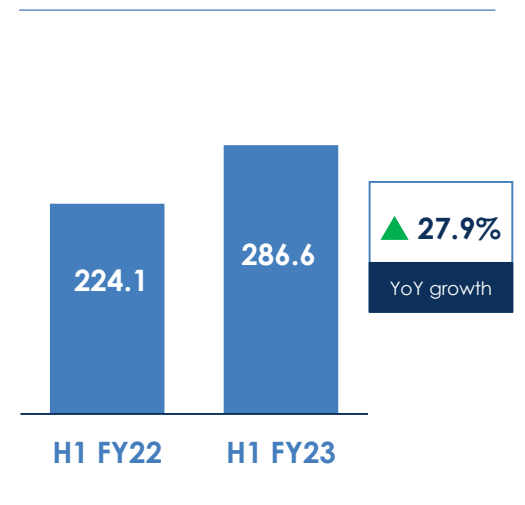

EBITDA (Rs cr.)

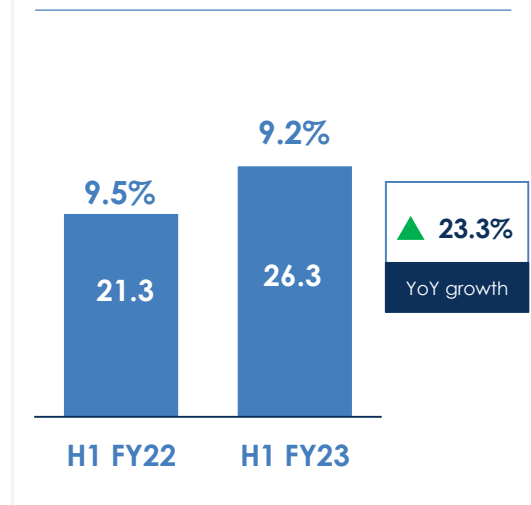

PAT (Rs cr.)

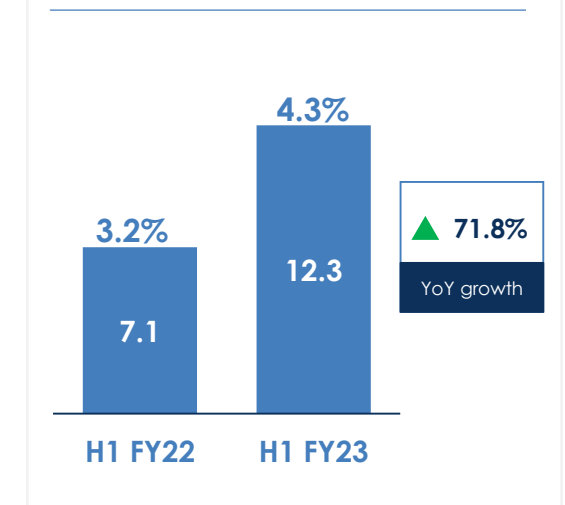

› **Total Revenue increased by 27.9% from Rs. 224.1 Cr in H1 FY22 to Rs. 286.6 Cr in H1 FY23**

- Sales to OE customer grew 36% supported by strong demand across vehicle segments
- Sales to Aftermarket customers grew 93%

› **EBITDA increased by 23.3% from Rs. 21.3 Cr in H1 FY22 to Rs. 26.3 Cr in H1 FY23**

- EBITDA margin decreased by 34 bps due to higher commodity price and unfavourable mix. Higher volumes and improved operational performance helped partially mitigate the higher material cost.

› **PAT increased by 71.8% from Rs. 7.1 Cr in H1 FY22 to Rs. 12.3 Cr in H1 FY23**



ZF Rane Automotive India Private Limited

H1FY23 Financial & Operational Performance



Business Drivers

- › Market upcycle in commercial vehicle segment aids growths in steering division
- › Occupant safety division benefits from evolving safety regulation in India
- › Approved under PLI scheme for localisation of inflator and webbing
- › Introducing latest technology products from Joint Venture partner's product portfolio

Operational Highlights

- › Certified as a 'Great Work place' by GPTW Institute, India

Business Split (H1 FY23)

BY MARKET (%)

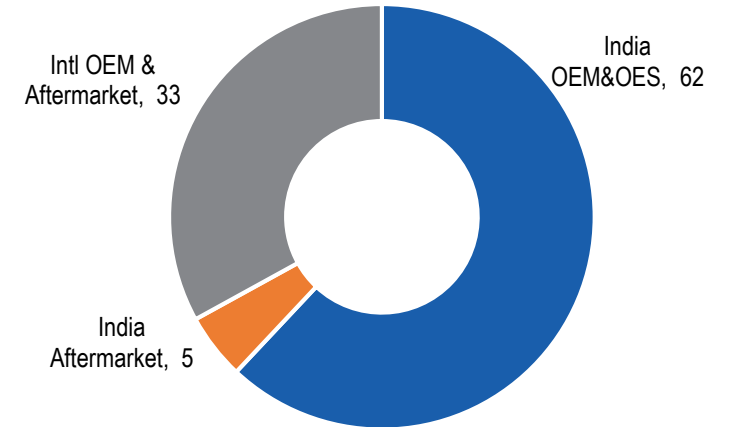

BY VEHICLE SEGMENT (%)

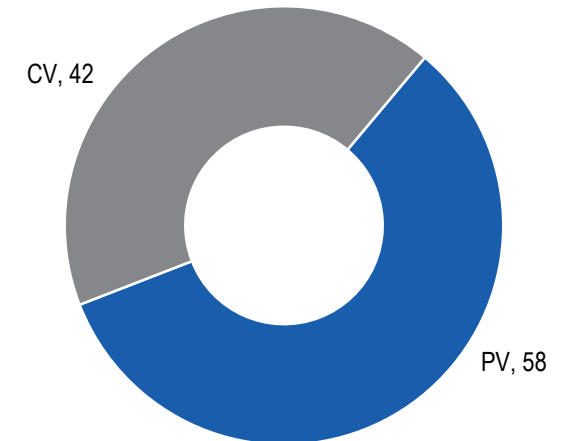

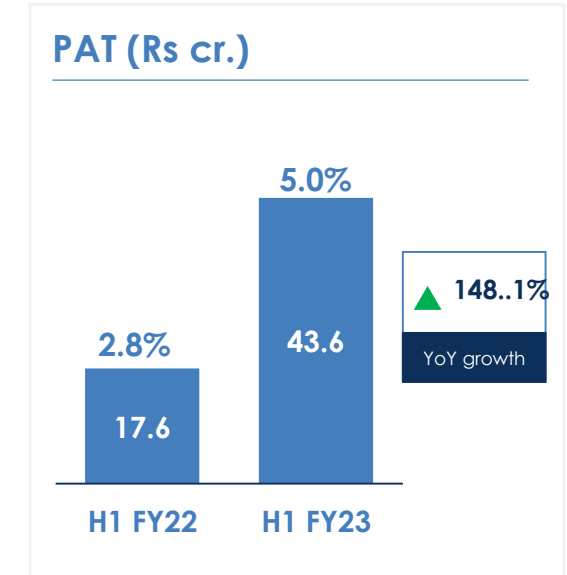
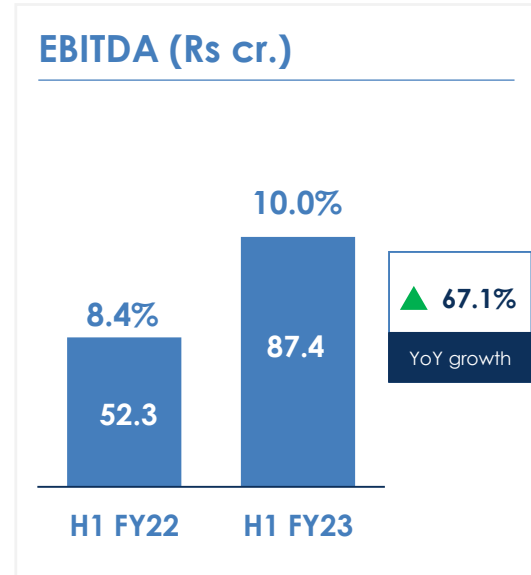
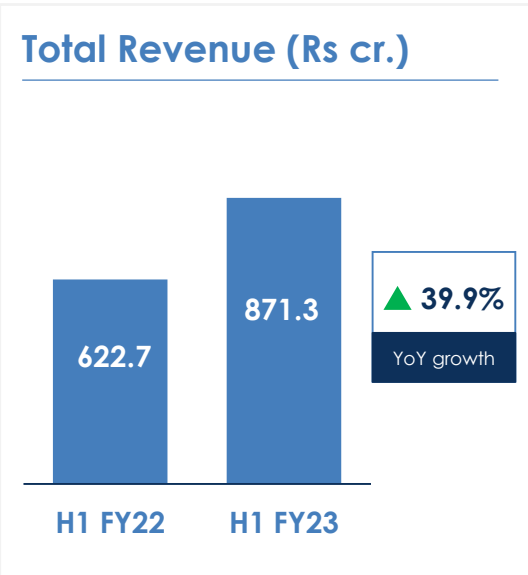

› **Total Revenue increased by 39.9% from Rs. 622.7 Cr in H1 FY22 to Rs. 871.3 Cr in H1 FY23**

- Revenue from steering gear products increased 61% supported by strong demand from commercial vehicle segment
- Revenue from occupant safety systems grew 27% supported by strong offtake on domestic served customers and export customers

› **EBITDA increased by 67.1% from Rs. 52.3 Cr in H1 FY22 to Rs. 87.4 Cr in H1 FY23**

- Favourable product mix and higher volumes helped improve margins

› **PAT increased by 148.1% from Rs. 17.6 Cr in H1 FY22 to Rs. 43.6 Cr in H1 FY23**



Rane NSK Steering Systems Private Limited

H1FY23 Financial & Operational Performance



Business Drivers

- › Favourable share of business with key customer
- › Strong growth for Manual Steering Column product with new product introductions

Operational Highlights

- › Operates with optimal capacity utilization
- › Guduvancherry plant won the National Award for Excellence in Energy Management - 2022" at CII 21st Energy Efficiency Summit - 2022, New Delhi.

Business Split (H1 FY23)

BY MARKET (%)

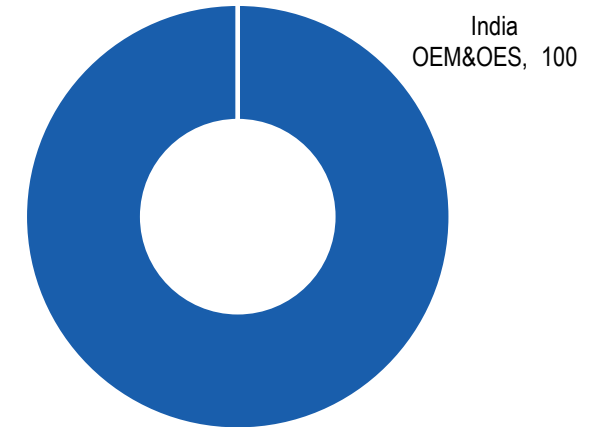

BY VEHICLE SEGMENT (%)

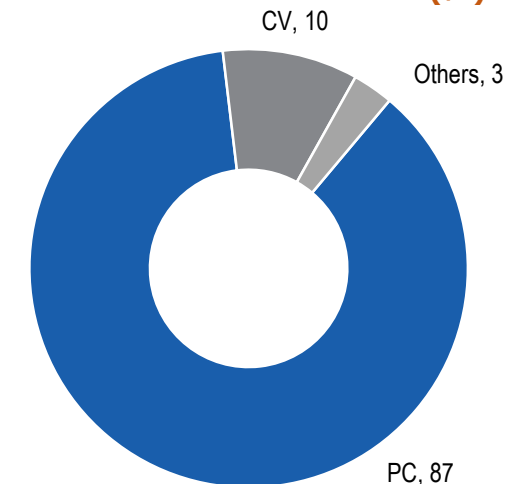

Total Revenue (Rs cr.)

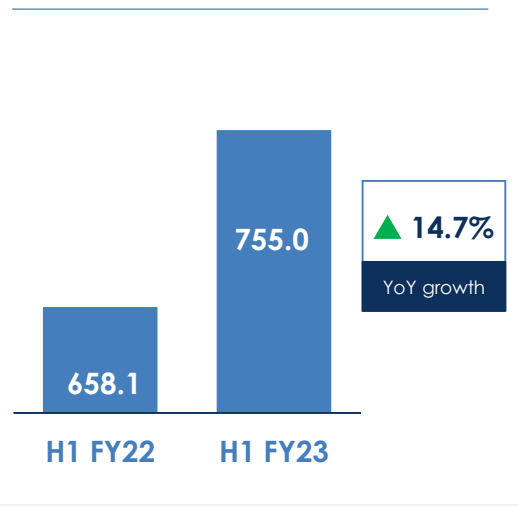

EBITDA (Rs cr.)

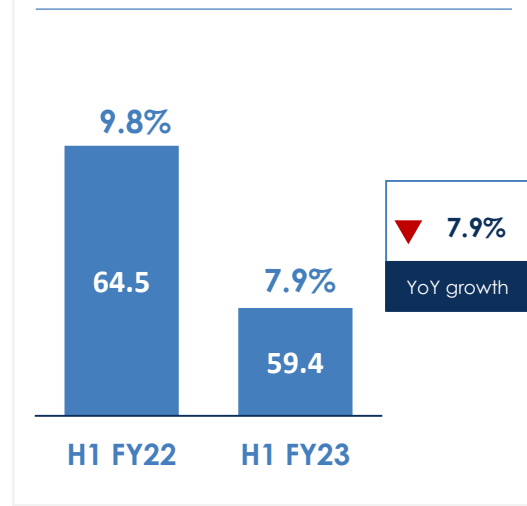

PAT (Rs cr.)

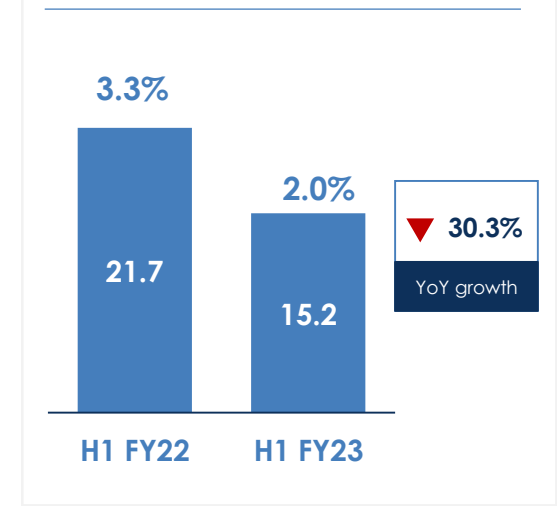

- › **Total Revenue increased by 14.7% from Rs. 658.1 Cr in H1 FY22 to Rs. 755.0 Cr in H1 FY23**
 - Manual steering column business benefitted on account of upcycle in the CV segment
 - EPS business faced slower demand on served models due to semiconductor shortage
- › **EBITDA decreased by 7.9% from Rs. 64.5 Cr in H1 FY22 to Rs. 59.4 Cr in H1 FY23**
 - Adverse product mix and increase in logistics cost impacted the profitability
- › **PAT decreased by 30.3% from Rs. 21.7 Cr in H1 FY22 to Rs. 15.2 Cr in H1 FY23**



Rane Group

About Us





Founded in 1929 and headquartered in Chennai, Rane Group is one of the preferred OE manufacturer and supplier for global auto majors



The Group serves a variety of industry segments: Passenger Vehicles, Commercial Vehicles, Farm Tractors, Two-wheelers, Three-wheelers, Railways and Stationary Engines



Manufactures Steering and Suspension systems, Friction materials, Valve train components, Occupant safety systems, Light metal casting products and provide Connected mobility solutions.

REVENUE BY MARKET (%)

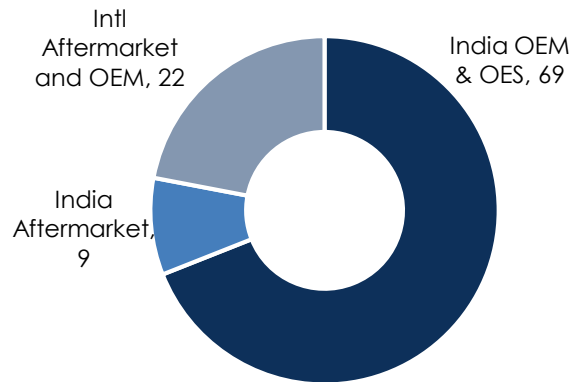

REVENUE BY VEHICLE SEGMENT (%)

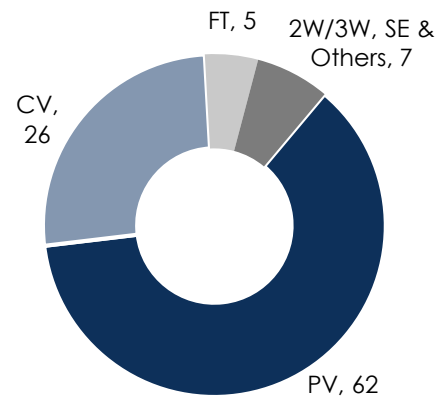

GROUP SALES OF INR 5,313 CR (~USD 700 MN)

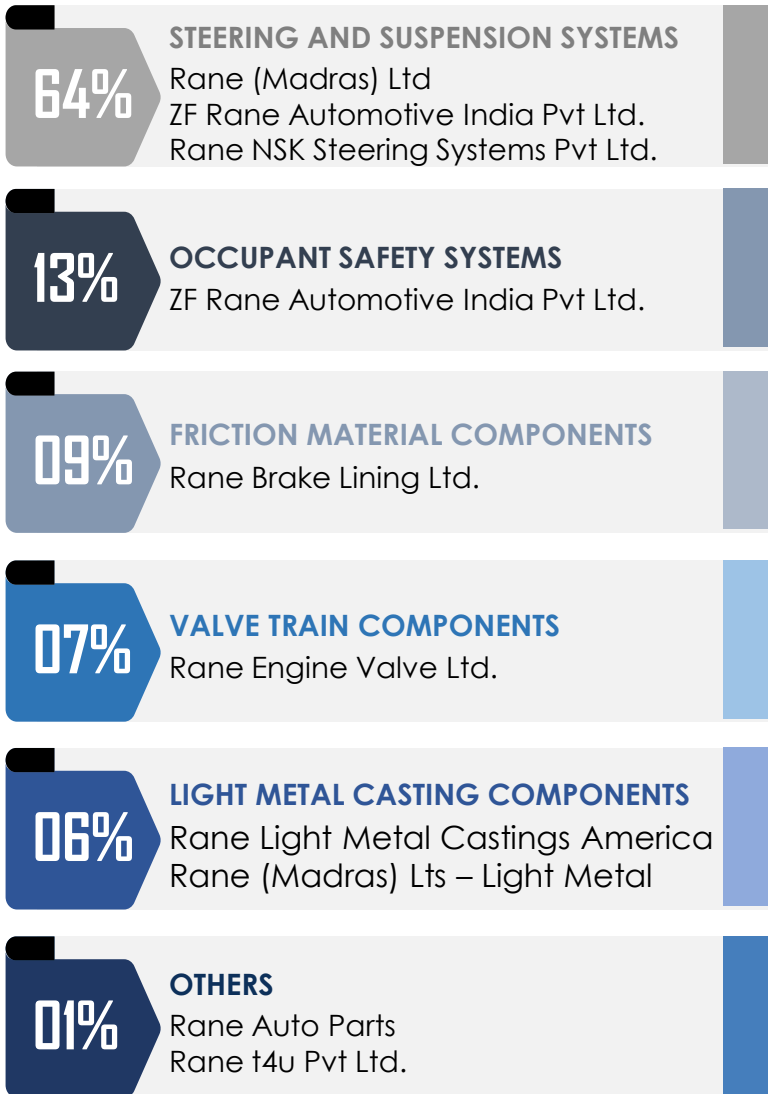

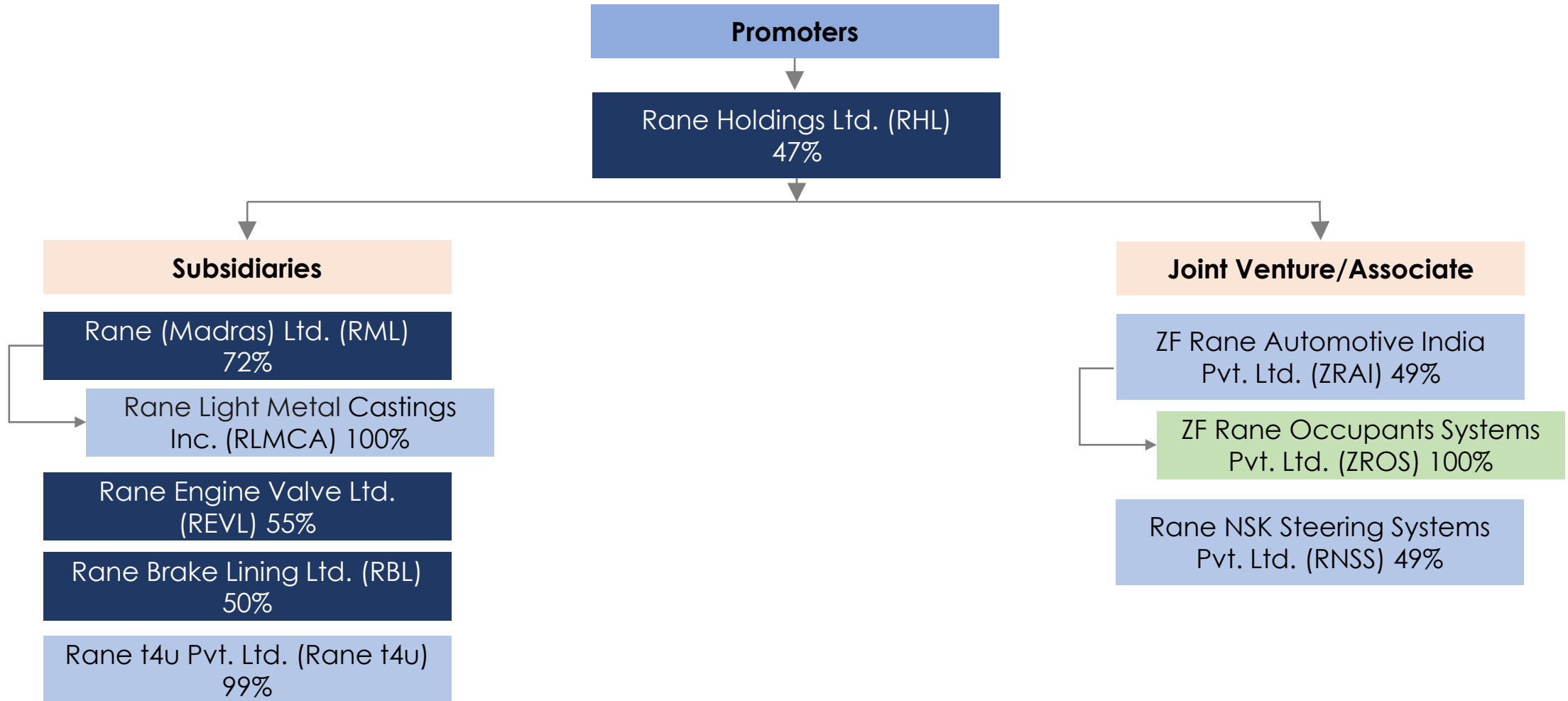

 Listed

Share holding as on 30 June 2022

- Market leader in steering gear and steering linkage products in India. We have started catering to hydraulic products such as HSU and steering cylinders.
- Best in class manufacturing facilities at Chennai, Mysore, Puducherry and Pant Nagar.
- End to end testing facilities in house to validate the products' functional, endurance and environmental parameters.

PRODUCTS

Steering and Linkage Business



Light Metal Castings India Business



Light Metal Castings AMERICA Business

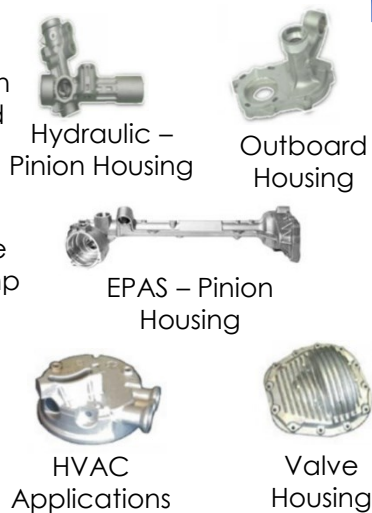

MANUFACTURING PLANT

Rudrapur Plant

Steering Gears

Hyderabad Plant

Bollaram Plant: Fully equipped plant for Aluminium HPDC castings & machining/sub-assembly line
Sadasivapet Plant: Fully equipped plant for Aluminium HPDC castings & machining/sub-assembly line

Chennai Plant

Light Commercial vehicle, Heavy Commercial vehicle and Utility vehicles segments

Puducherry Plant

Mysore Plant

Tractor and Commercial vehicle segments, and Hydraulic products

- Incepted In 1959, REVL manufactures valves and valve train components for various engine applications
- Non Automotive applications such as power generation, marine, defence, locomotive, etc.
- Comprehensive test laboratory for material characterisation, simulated test rigs and engine dynamometer test facility.

PRODUCTS

Engine Valves



Valve Guides



Mechanical Tappets



MANUFACTURING PLANT



Hyderabad Plants (2)

Small Valves for 2W and PC
Medium Valves for PC, Industrial and CV

Chennai Plant

Small Valves for 2W and PC
Medium Valves for Tractors and PC
Guides, Tappets

Tumakuru Plant

Medium Valves for CV and Farm
Tractors
Large & Extra Large Valves for
Industrial, Power Generation and
Marine Applications

Trichy Plant

Small & medium Valves for 2W, PC
and CV

- Established in 1964, RBL is a leader in Friction Products across OEM segments and supplies products to over 15 countries
- Technical collaboration with Nisshinbo Brakes Inc. and TMD Friction
- Library of widely tested and approved formulations to suit diverse market / customer requirements.
- State-of-the-art R&D center equipped with full scale inertia dynamometer, static mu-measurement and NVH study rig.

PRODUCTS

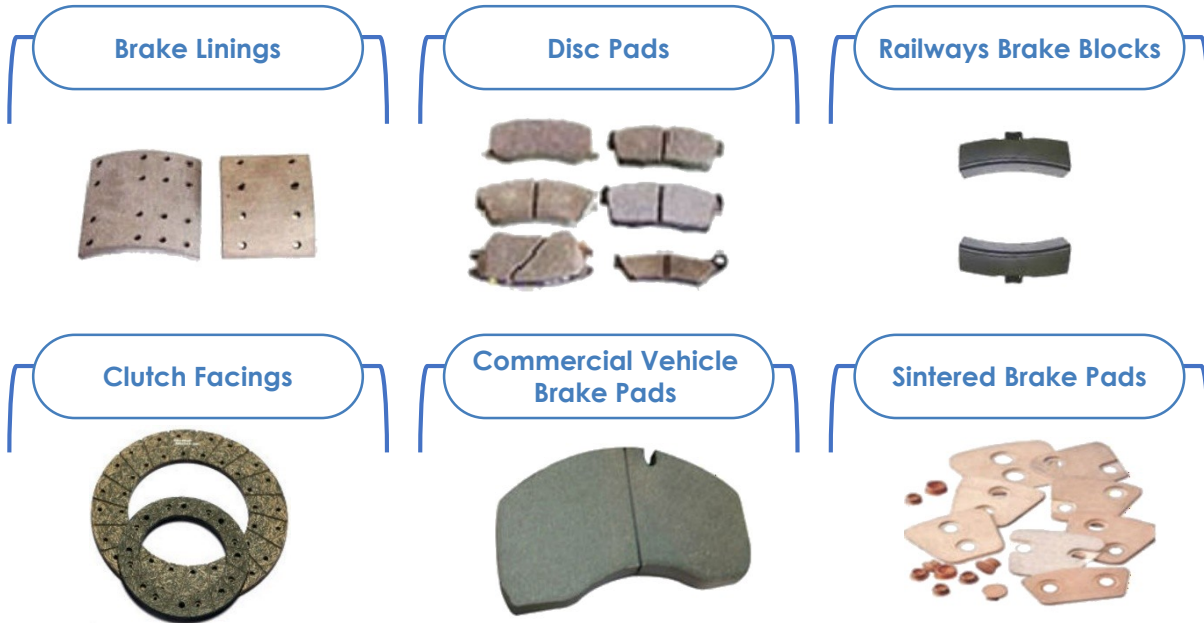

MANUFACTURING PLANT

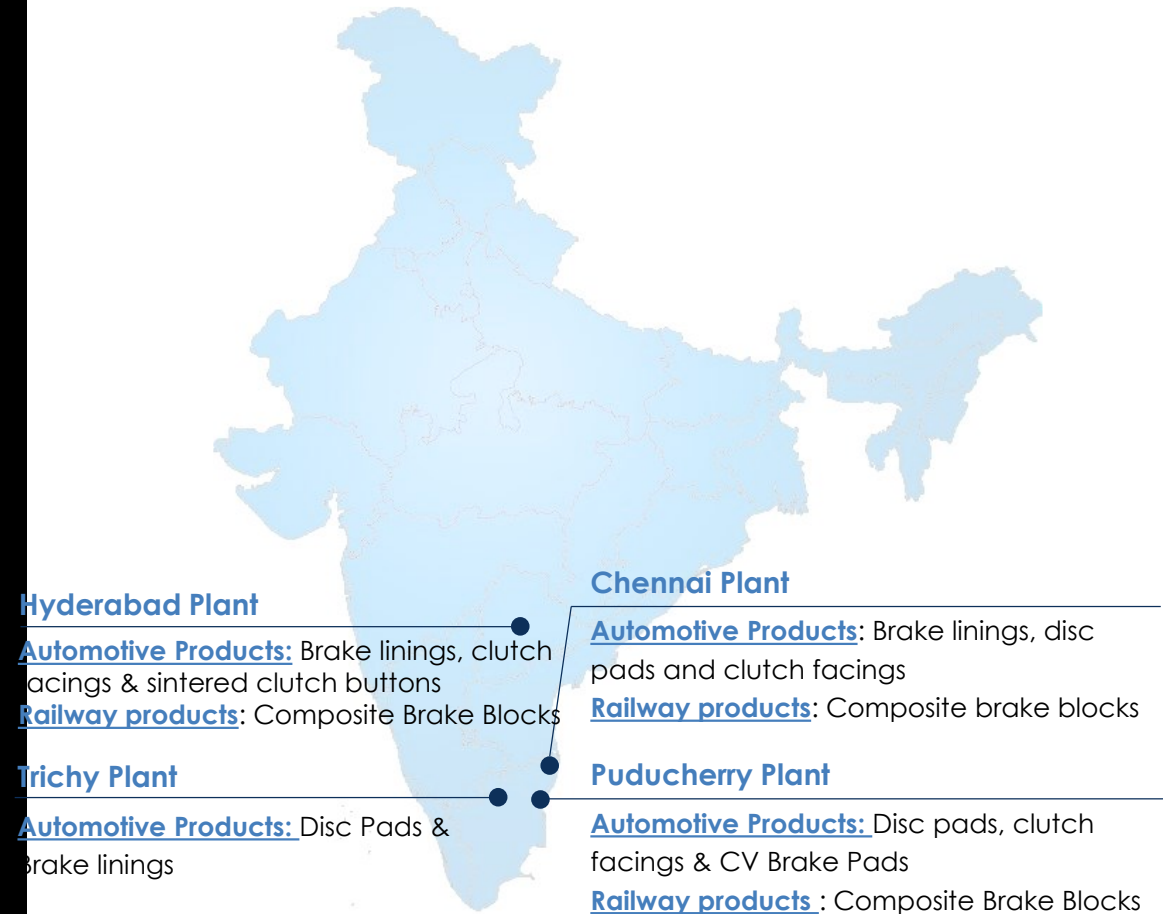

Joint venture partnership with ZF Group, Germany.

Steering Gear Division

- Design, Development and Application capability for complete Hydraulic Power Steering system for all vehicles.
- Advanced design tools for 3D modeling, simulation, FE analysis and CFD.
- State-of-the-art testing facilities for strength, environment, noise, fatigue and durability tests to meet global standards

Occupant Safety Division

- Product range includes different types of airbags and latest seatbelt technologies, Retractor and Anchor pretensioners, Emergency Locking Retractor (ELR), Load Limiters, Child Restraint Seat Belt, Driver Airbag, Passenger Airbag, Side Airbag and Curtain Airbags.
- Extensive testing facilities for seat belts include Extraction and Retraction Force Testing Machine, Retractor Durability Tester, Hot & Cold Chamber, Salt spray chamber, ELR functional tester.
- Equipped with Test lab to carry out testing as per National (IS/AIS), International (ECE/EEC/GS/VSCC), customer specifications and COP testing

PRODUCTS

Steering Gear Division



Occupant Safety Division



MANUFACTURING PLANT

Rudrapur Plant

Steering Gears and Pumps

Chennai Plant (3)

Pump and Power Rack & Pinion division, Occupant Safety Products

Tiruchirapally Plant (2)

Fully integrated gear, Occupant Safety Products

- Joint venture partnership with NSK, Japan.
- State-of-art R&D test lab for validation of steering columns.
- Manufacturing facilities across four locations in Chennai, Bawal, Rudrapur & Ahmedabad.
- Design & Development capability for solid & energy absorbing columns. Development and application capability for EPS.
- Driver comfort, Passenger safety, Ergonomics and NVH requirements are kept as targets while designing steering system.
- Comprehensive test laboratory for extensive research about column performance characteristic validation, strength and durability validation and NVH requirements.
- Design team includes CAD & CAM application experts and software analysts.

PRODUCTS



MANUFACTURING PLANT

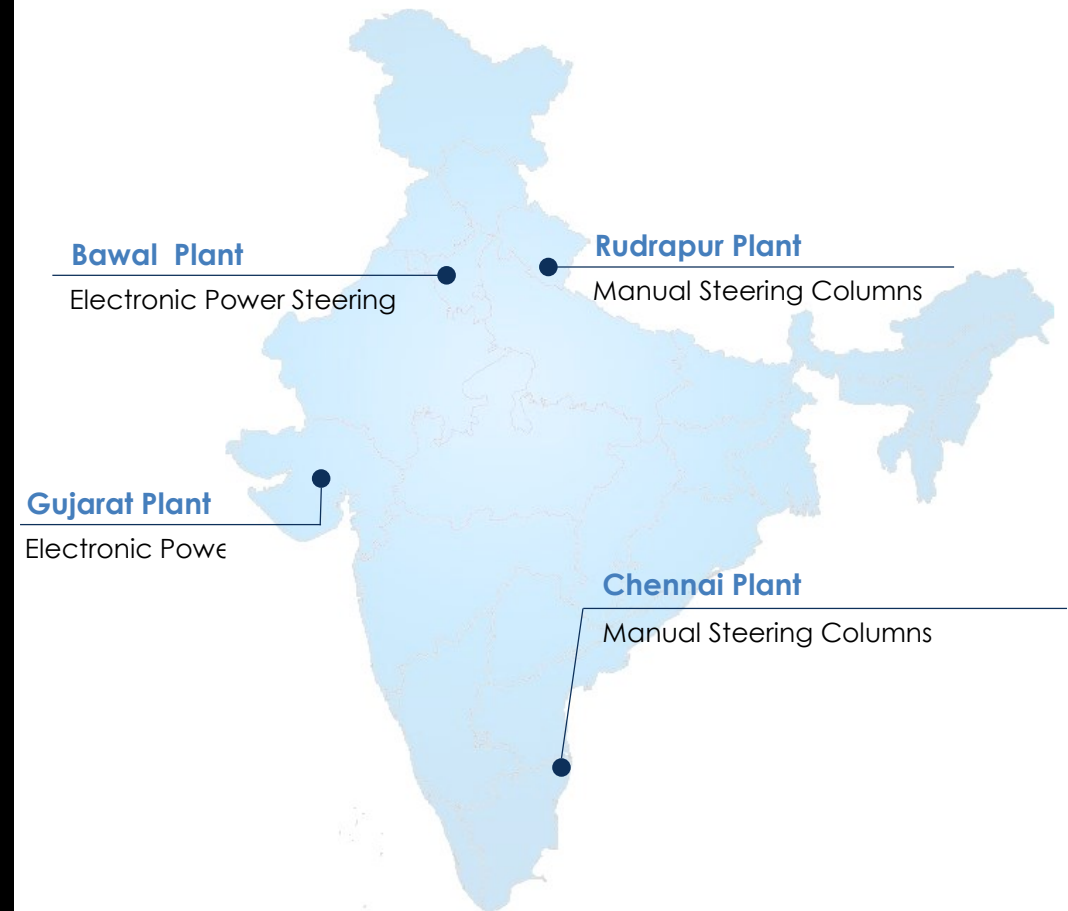

Light Metal Casting Products

Pinion Housing

Engine Timing Case Cover

Outboard Housing

Valve train Components

Engine Valves

Occupant Safety Systems

Seat Belts

Airbags

Friction Materials

Brake Lining

Disc Pad

Upper Control Arm

Stabilizer Link

Lower Control Arm

Steering & Suspension Systems

Suspension Ball Joint

Outer Ball Joint

Inner Ball Joint

Power Steering Pump

RACK & PINION steering gear
-Mechanical
-Hydraulic

Electric Power Steering Columns

Rane (Madras)

- › Manual Steering Gears
- › Steering Linkages
- › Suspension Components
- › Light Metal Casting Products

Rane Engine Valve

- › Engine Valves

Rane Brake Lining

- › Brake Linings
- › Disc Pads

Rane NSK Steering Systems

- › Electric Power Steering Systems

ZF Rane Automotive India Pvt Ltd.

- › Hydraulic Power Steering systems
- › Seat Belts
- › Airbags

Steering & Suspension Systems



Manual Steering Column



Power Steering Gear



Power Steering Pump



Manual RCB Steering Gear



Drag Link Assembly



Tie Rod Assembly



Hydraulic Cylinder (Twin/multi front axle trucks)

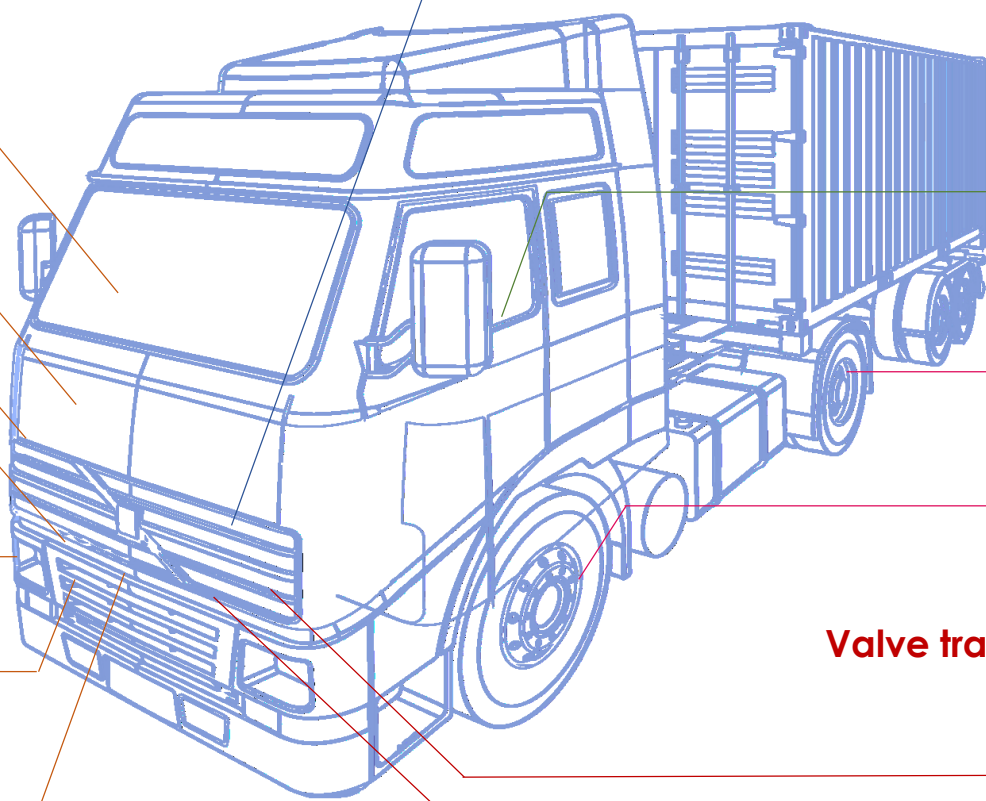

Light Metal Casting Products

Hydraulic Pump Housing



Occupant Safety Systems

Seat Belts



Friction Materials

Brake Lining



Disc Pad



Valve train Components

Valve Guides



Engine Valves



Rane (Madras)

- › Manual Steering Gears
- › Steering Linkages
- › Hydraulic Cylinders
- › Light Metal Casting Products

Rane Engine Valve

- › Engine Valves
- › Valve Guides

Rane Brake Lining

- › Brake Linings
- › Brake Pads

Rane NSK Steering Systems

- › Manual Steering Column

ZF Rane Automotive India Pvt Ltd.

- › Hydraulic Power Steering Systems
- › Seat Belts

Steering & Suspension Systems



Manual Steering /
Column
Manual RCB
Steering Gear



Hydrostatic
Steering Unit



Power Steering
Gear



Drag Link Assembly



Tie Rod Assembly

Hydraulic
Cylinder



Friction Materials

Clutch Facings



Brake Lining



Light Metal Casting Products

Timing Case Covers



Valve train components

Valve Guides



Engine Valves

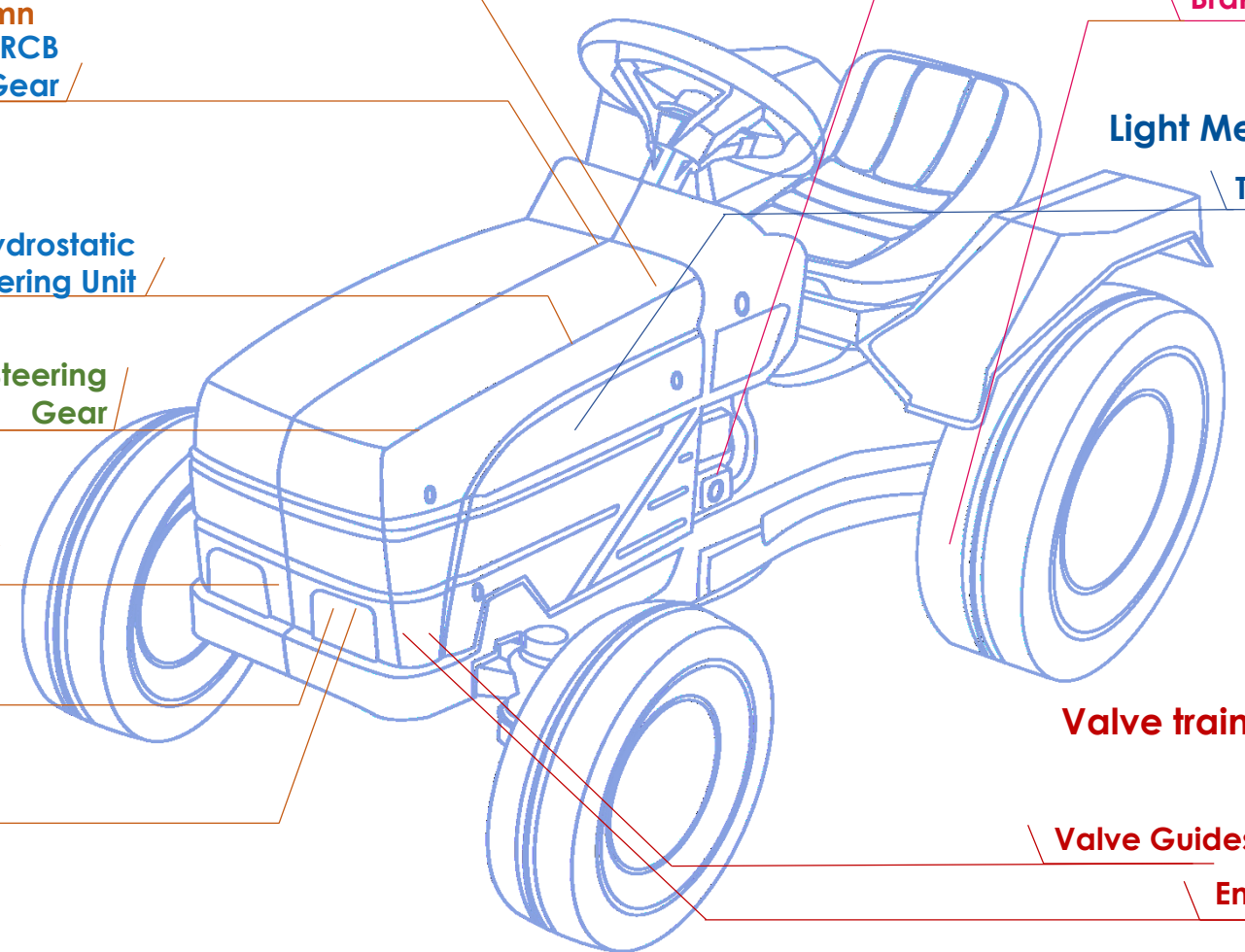

Rane (Madras)

- › Manual Steering Gears
- › Steering Linkages
- › Hydraulic Cylinders
- › Hydrostatic Steering Unit
- › Light Metal Casting Products

Rane Engine Valve

- › Engine Valves
- › Valve Guides

Rane Brake Lining

- › Brake Linings
- › Clutch Facings

Rane NSK Steering Systems

- › Manual Steering Column

ZF Rane Automotive India Pvt Ltd.

- › Hydraulic Power Steering systems

Light Metal Casting Products

Battery Box & Cover

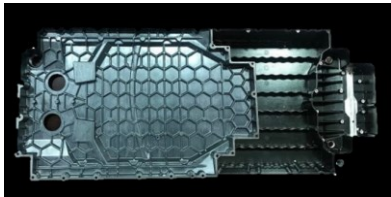

Friction Materials

Disc pad

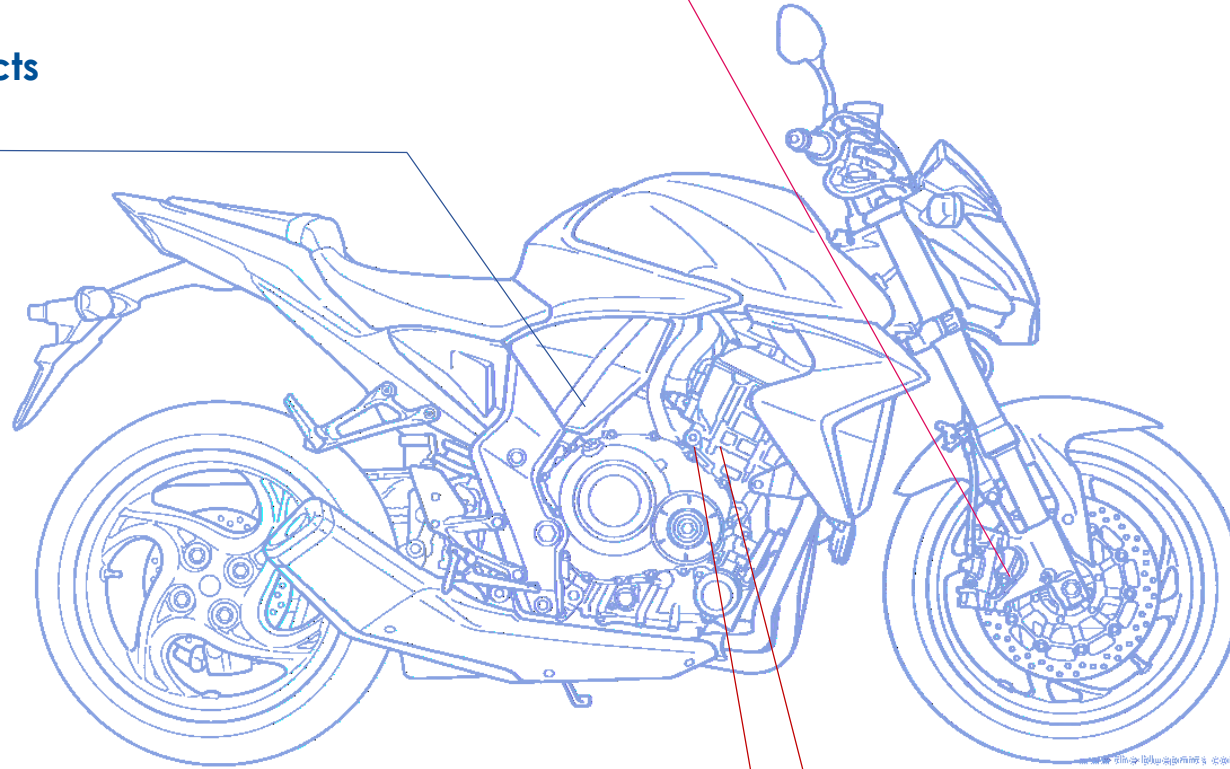

Rane (Madras)

- › Light Metal Casting Products

Rane Brake Lining

- › Disc Pads

Rane Engine Valve

- › Engine Valves
- › Valve Guides

Valve train Components

Valve Guides



Engine Valves



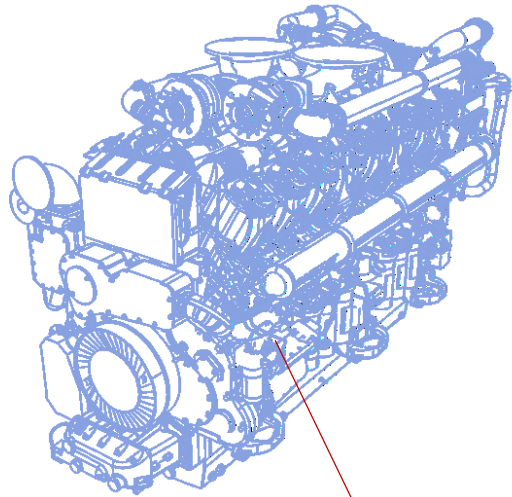

Engine Valves / Valve Guides

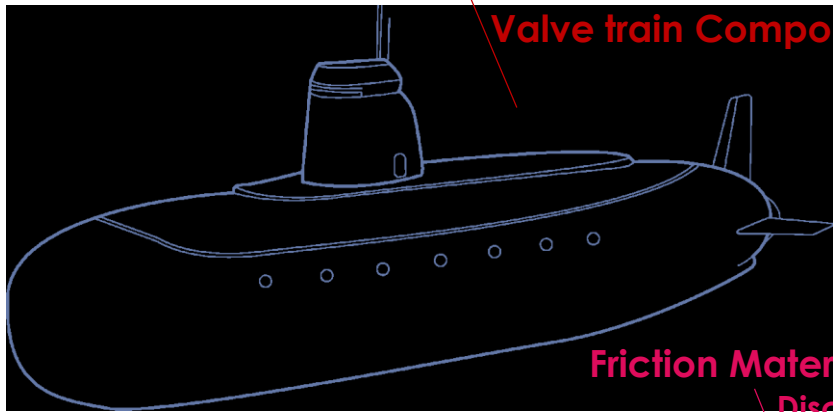

Valve train Components



Friction Materials / Disc pad

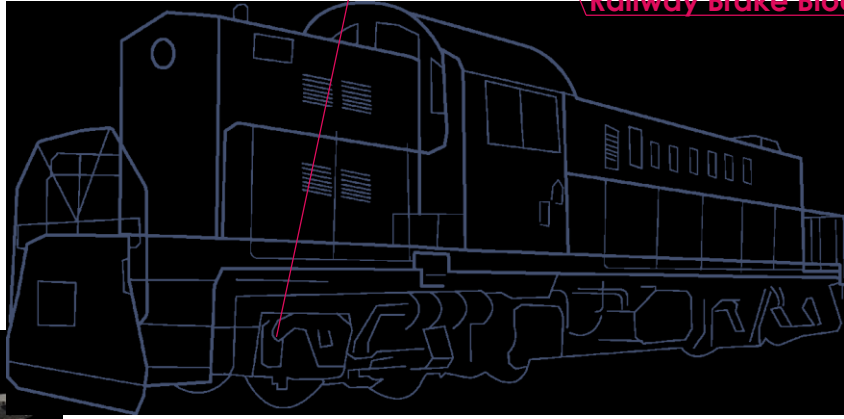

Railway Brake Block



Sintered Brake Pads

Friction Materials

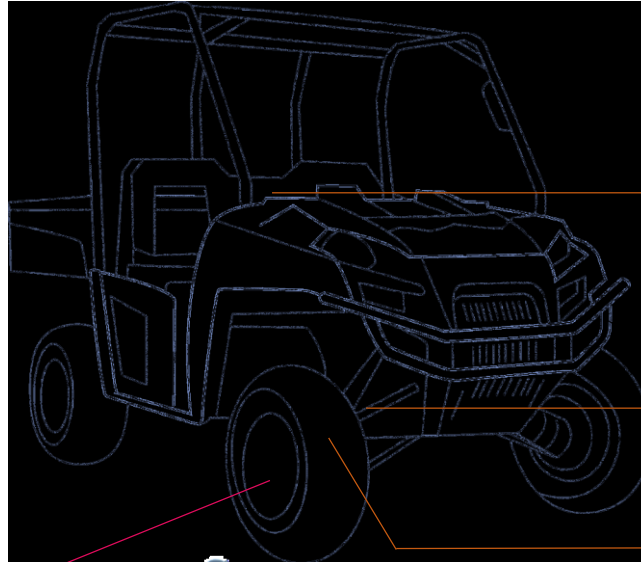

Steering & Suspension Systems



Manual Steering column



Rack & Pinion steering gear -Mechanical



Stabilizer link

- Rane (Madras)**
 - > Manual Steering Gears
 - > Steering Linkages
 - > Light Metal Casting Products
- Rane Engine Valve**
 - > Engine Valves
 - > Valve Guides
- Rane Brake Lining**
 - > Sintered Brake Pads
 - > Railway Brake Block
- Rane NSK Steering Systems**
 - > Manual Steering Column

An illustrious journey of over 80 years from distributor of automobile and auto components to winner of Deming prize for manufacturing

Distribution

1929 - 1958

- › 1929 - Founded as a distributor of automobiles and spare parts
- › 1936 - Incorporated as a Public Ltd. Company

Manufacturing

1959 - 1986

- › Started manufacturing IC Engine Valves, Tie Rod Ends, Friction Material Products and Manual Steering Gears

Collaboration

1987 - 2000

- › Established JV with TRW (currently ZF) and NSK to offer power steering systems, occupant restraint systems and energy absorbing steering columns

Operational Excellence

2000 - 2014

- › TQM Journey with Deming Grand Prize for 3 companies and Deming Prize for 5 companies
- › Started manufacturing high pressure aluminium die cast products, electric power steering and airbags

Expanding Horizons

2015 onwards

- › Established Rane Auto Parts
- › Expanded footprint in USA with the acquisition of Precision Die Casting, Inc.
- › Acquired Rane t4u Pvt. Ltd. , Bengaluru



30+ Serve customers in 30+ countries

26 Manufacturing locations across India and USA

Customer Locations Manufacturing Locations Sales Offices

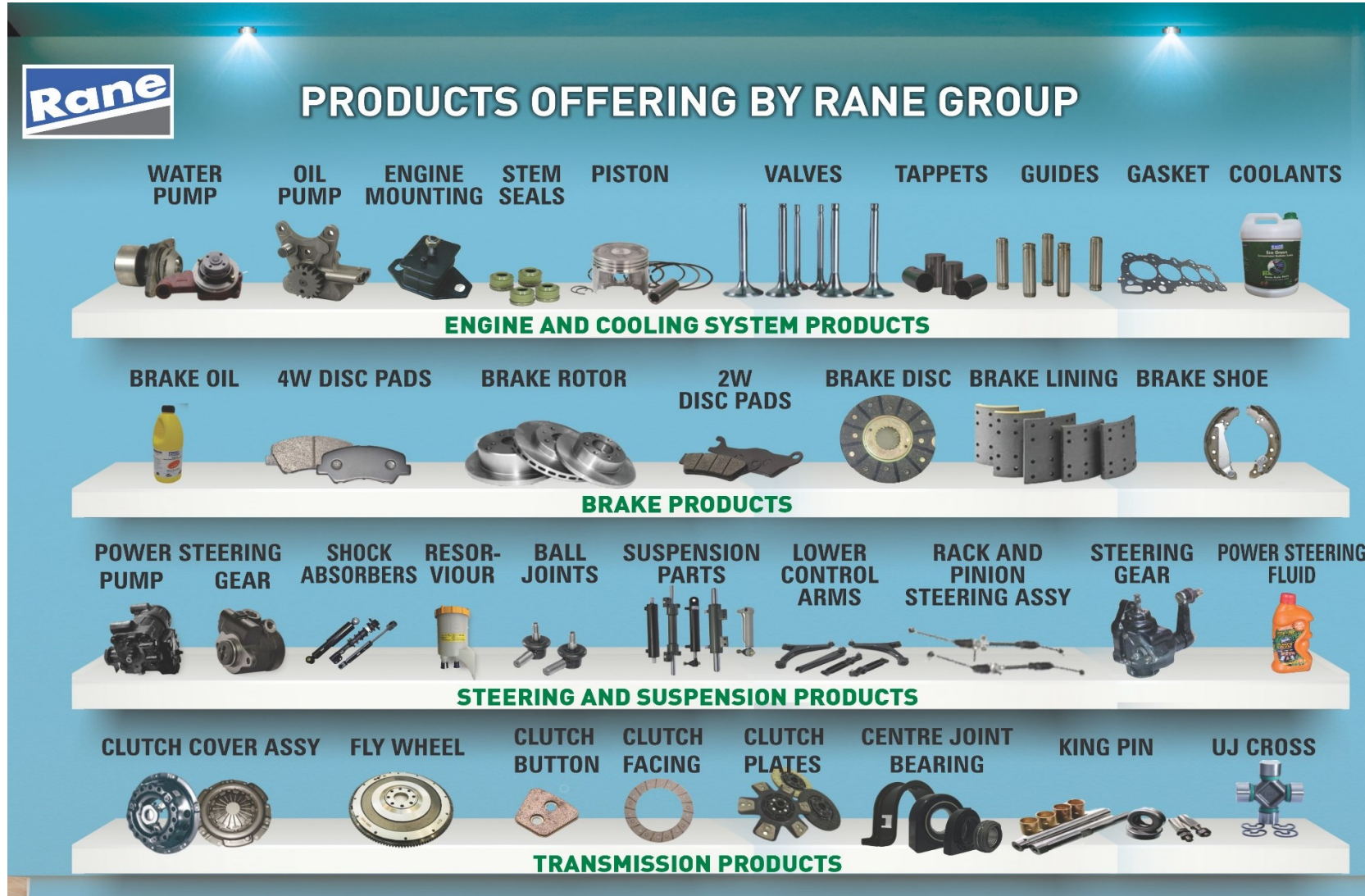

Increasing Group's brand presence in aftermarket through enhanced product portfolio and wider market reach

Strong CAE Capabilities – Design, Analysis & Simulation Software

230 R&D Engineers

42 Functional Test Rigs

26 Strength Test Rigs

62 Durability Test Rigs

33 Environmental Test Rigs

10 Noise Test Rigs



Hydraulic Power Steering Systems and Occupant Safety Systems



Energy Absorbing Steering Columns and Electric Power Steering



Brake Linings, Discs Pads and Clutch Facings

Passenger Vehicle

Commercial Vehicle

Farm Tractor

Two/Three-Wheeler

Other Applications

INDIA



INTERNATIONAL



Customer at the core' remains our priority on the goal to sustainable growth and profitability



Rane Group

Customer	Award Category
Mahindra & Mahindra	Business Partner of the year – Automotive Division



Rane (Madras)

Customer	Award Category
Volvo Eicher	New Product Development Award
Nexteer TAFE	Perfect Quality Award Best Supplier & Benchmark Award
Maruti Suzuki	Superior Performance Award, Special Support
SML Isuzu	New Product Development Award
Tata Motors	Award for Exceptional Support, Best Supplier – Demand Fulfillment
Toyota Industries	Best Target Achieved Supplier Award



Rane Brake Lining

Customer	Award Category
Brakes India	Best Supplier - Friction
Ashok Leyland	After Market Support Award
Foundation Brake	Business Excellence Award
Endurance	Gold Award for Quality Best Benchmark Award, Best Supplier Award



Rane Engine Valve

Customer	Award Category
Groupe Renault	Quality & Customer Satisfaction
John Deere India	Quality Appreciation Award
Volvo Eicher	Quality & Delivery excellence
Renault Nissan	Quality & Customer Satisfaction
Hyundai	Appreciation Award
Cummins India	Superior Quality Award



ZF Rane

Customer	Award Category
Ashok Leyland	Best Performance in Business Alignment-Gold
Isuzu Motors	Most Improved Supplier Award
Tata Motors	Best Supplier Award, Efficiency Award, Best in Class Award
Volvo Eicher	Best Supplier in NPD, Supply Chain
Daimler India	Quality Appreciation Award
Renault Nissan	Best Supplier in Field Quality



Rane NSK

Customer	Award Category
Maruti Suzuki	Efforts in Vendor Import Localisation
Honda Cars	Award for best reduction in CO2
Volvo Eicher	Kata Award

Rane Values

- › Provide superior products and maintain market leadership
- › Pursue excellence
- › Achieve the highest standard of ethics and integrity

Rane Approach

- › Build strong connections with customers to understand their challenges
- › Strategic investments to improve quality and productivity
- › TQM way of working
- › Emphasis on 'First-time right' policy

Rane Credentials

- › Modern manufacturing facilities with TS 16949 certification
- › State-of-the-art product development and validation capabilities
- › Deming Grand Prize for 3 Rane companies
- › Deming Prize for 5 Rane companies



- › Technology collaboration with top global players



ZF Group, Germany
Hydraulic Power Steering Systems and Occupant Safety Systems



NSK, Japan
Energy Absorbing Steering Columns and Electric Power Steering



Nisshinbo Brake Inc., Japan
Brake Linings, Disc Pads and Clutch Facings

Value Proposition

- › Superior products driven by execution excellence
- › Trusted partner with shorter development lead times
- › Agile manufacturing process and scalable facilities
- › Provide system-level solutions with deep understanding of customer needs
- › With enhanced R&D capabilities, we provide light-weighting, improved safety and performance

**LONG TERM PARTNER OF CHOICE TO LEADING
AUTOMOTIVE COMPANIES AND TIER 1 SUPPLIERS**

An exciting workplace founded on the principles of values, fairness and transparency that:



Provides challenging assignments

Encourages learning

Enhances career opportunities



- › **Organisation Development Excellence Award** for the exceptional practices on **Leadership Development** by Transcendence, Tata Institute of Social Sciences (TISS), 2019
- › Recognized by International Federation of Training and Development Organizations in Best HRD practice category, 2018
- › Award for **Talent Management** from the Employer Branding institute, Singapore, 2012 & 2014
- › Significant Achievement in **HR Excellence**, CII, 2012



Certified as a **Great Workplace** by the Great Place to Work institute, 2022



Systems approach to deliver H&S to our employees

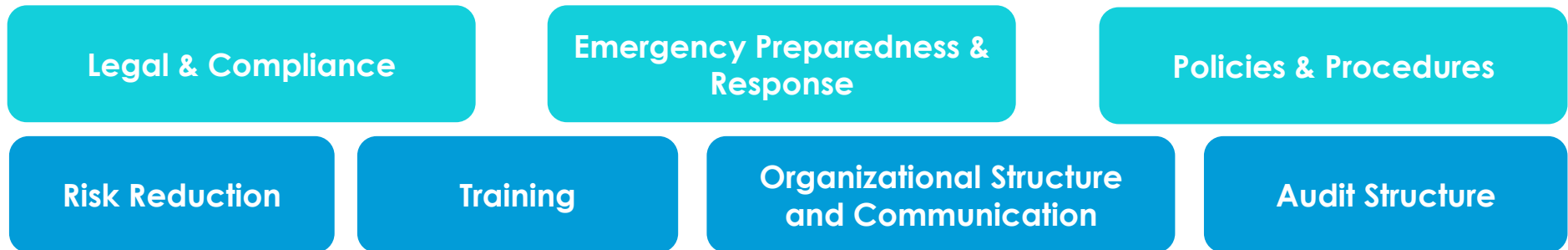

- › Rane Foundation (RF) is a **public charitable trust** founded by Rane's promoters in the year 1967
- › RF is the **main arm for Rane's Corporate Social Responsibility (CSR) initiatives** and is exclusively funded by the Rane companies
- › Initiatives are focused on **education, healthcare, environment and community development**

Rane Polytechnic



Education

- › Institution Development - Rane Polytechnic, Rane Vidyalaya
- › Vocational Training & Skill Development
- › Awareness programs



Healthcare

- › Nutrition program
- › Health camps
- › Medical infrastructure & aid



Environment

- › Plantation drives
- › Infrastructure for sustainability
- › Natural resource preservation



Community Development

- › Providing amenities & sanitation
- › Improving quality of life
- › Rural infrastructure development program

Rane Vidyalaya



Thank You

For further information, please contact:

investorservices@ranegroup.com or diwakar.pingle@in.ey.com

Rane Corporate Centre

"Maithri" 132, Cathedral Road,
Chennai - 600 086, India
www.ranegroup.com

Glossary of Abbreviations

Abbreviation	Expansion	Abbreviation	Expansion
ACMA	Automotive Component Manufacturers Association	PBT	Profit Before Tax
bps	Basis point, 100 bps equal to 1%	PC	Passenger Car
BV	Book Value per share	PLE	Production Linked Incentive
Cr	Crores	PPM	Parts Per Million
CV	Commercial Vehicle	Pvt	Private
DPS	Dividend per share	H1	Half Year 1
EBITDA	Earnings Before Interest, Tax, Depreciation and Amortization	SE	Station Engine
FT	Farm Tractors	Rane T4U	Rane T4U Pvt Limited
FY	Financial Year	REVL	Rane Engine Valve Limited
GPTW	Great Place To Work	RHL	Rane Holdings Limited
HR	Human Resource	RLMCA	Rane Light Metal Casting Inc
Intl	International	RML	Rane (Madras) Limited
JV	Joint Venture	RNSS	Rane NSK Steering Systems Pvt Limited
LCV	Light Commercial Vehicles	SCV	Small Commercial Vehicles
Ltd	Limited	SIAM	Society of Indian Automobile Manufacturers
M&HCV	Medium & Heavy Commercial Vehicles	US	United States
Mn	Million	USD	United States Dollar
MPV	Multi Purpose Vehicles	UV	Utility Vehicle
MUV	Multi Utility Vehicles	VRS	Voluntary Retirement Scheme
NPD	New Product Development	YoY	Year-on-Year
OE	Original Equipment	YTD	Year To Date
OEM	Original Equipment Manufacturer	ZRAI	ZF Rane Automotive India Pvt limited
OES	Original Equipment Supplier		(Formerly knowns Rane TRW Steering Systems Pvt Ltd)
PAT	Profit After Tax	ZROS	ZF Rane Occupants Systems Pvt Ltd.
		2W/3W	Two Wheeler/Three Wheeler

This presentation may contain certain forward looking statements concerning Rane's future business prospects and business profitability, which are subject to a number of risks and uncertainties and the actual results could materially differ from those in such forward looking statements. The risks and uncertainties relating to these statements include, but not limited to risks and uncertainties regarding fluctuations in earnings, our ability to manage growth, competition (both domestic and international), economic growth in India and the target countries for exports, ability to attract and retain highly skilled professionals, government policies and action with respect to investments, fiscal deficits, regulations etc., interest and other fiscal costs generally prevailing in the economy. The company does not undertake to make any announcement in case any of these forward looking statement become materially incorrect in future or update any forward looking statements made from time to time by or on behalf of the Company.