

Registered Office  
"Maithri"  
132, Cathedral Road,  
Chennai 600 086, India.  
CIN: L65993TN2004PLC052856

Tel: 91 44 2811 2472  
URL: [www.ranegroup.com](http://www.ranegroup.com)

## Rane (Madras) Limited



// Online submission //

RML / SE /048/ 2023-24

November 10, 2023

<b>BSE Limited</b> <b>Listing Centre</b> Scrip Code: <b>532661</b>	<b>National Stock Exchange of India Ltd.</b> <b>NEAPS</b> Symbol: <b>RML</b>
--	--

Dear Sir / Madam,

**Sub: Earnings Presentation – Quarterly Unaudited Financial Results for the quarter ended September 30, 2023**

**Ref:Our letter no(s). RML/SE/045/2023-24 dated October 30, 2023 and RML/SE/047/2023-24 dated November 07, 2023**

This is with reference to the aforementioned letters intimating Earnings Conference Call scheduled on **Friday, November 10, 2023 at 14:00 hours (IST)**, inter alia, to discuss the unaudited financial results for the quarter ended September 30, 2023. We enclose herewith copy of the Earnings presentation proposed to be made thereat, to the analyst and investors.

The same is also being made available on the website of the Company, [www.ranegroup.com](http://www.ranegroup.com).

We request you to take the above on record and note the compliance with SEBI (Listing Obligations and Disclosure Requirements) Regulations, 2015 (SEBI LODR).

Thanking you,

Yours faithfully,

**For Rane (Madras) Limited**

S Subha Shree  
**Secretary**

Encl: a/a

# **Rane Group**

---

Earnings Presentation | Q2 FY24

# Table of Contents



Q2 FY24 Financial & Operational Performance

Rane Group Overview



# Rane Group

## Q2 FY24 Financial & Operational Performance



To become the Preferred Trusted Supplier of Safety & Critical Auto Components

## Strategic pillars of growth

---

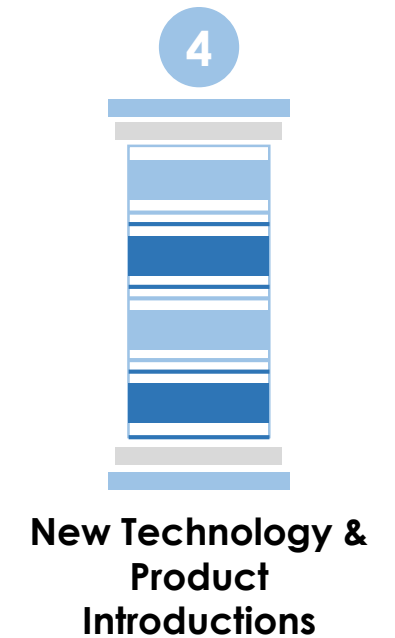
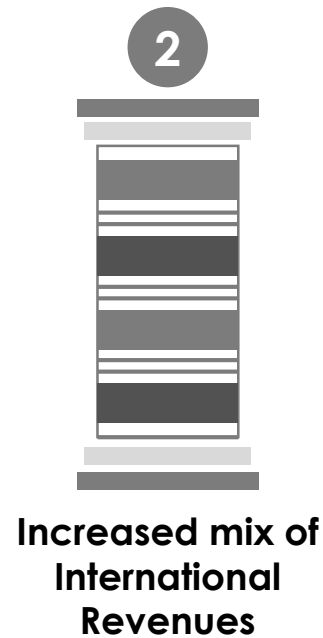

## Business Drivers

- › **92%+ of revenue comes from powertrain agnostic products**
- › **Continued dominance on domestic market across major products**
- › **Increasing export mix for steering & linkages, valve train components and occupant safety products**
- › **Renewed focus on Aftermarket segment leveraging group level synergy**
- › **Continuous new product introductions leveraging strong in-house engineering capabilities**
- › **Increasing efficiencies across manufacturing facilities through operational excellence and digitalization.**

## RANE BRAKE LINING

- Won orders worth Rs. 7 Cr from various domestic customers for PV application
- Won order worth Rs. 2 Cr from domestic customer for 2W application

## RANE (MADRAS)

- Won Rs. 50 Cr order for RCB from domestic LCV customer
- Won Rs. 24 Cr order for Light Metal Casting products from export customer
- Won Rs.10 Cr order for linkages from CV customer including an EV SCV application
- Won Rs. 26 Cr order for Rack & Pinion from various customer

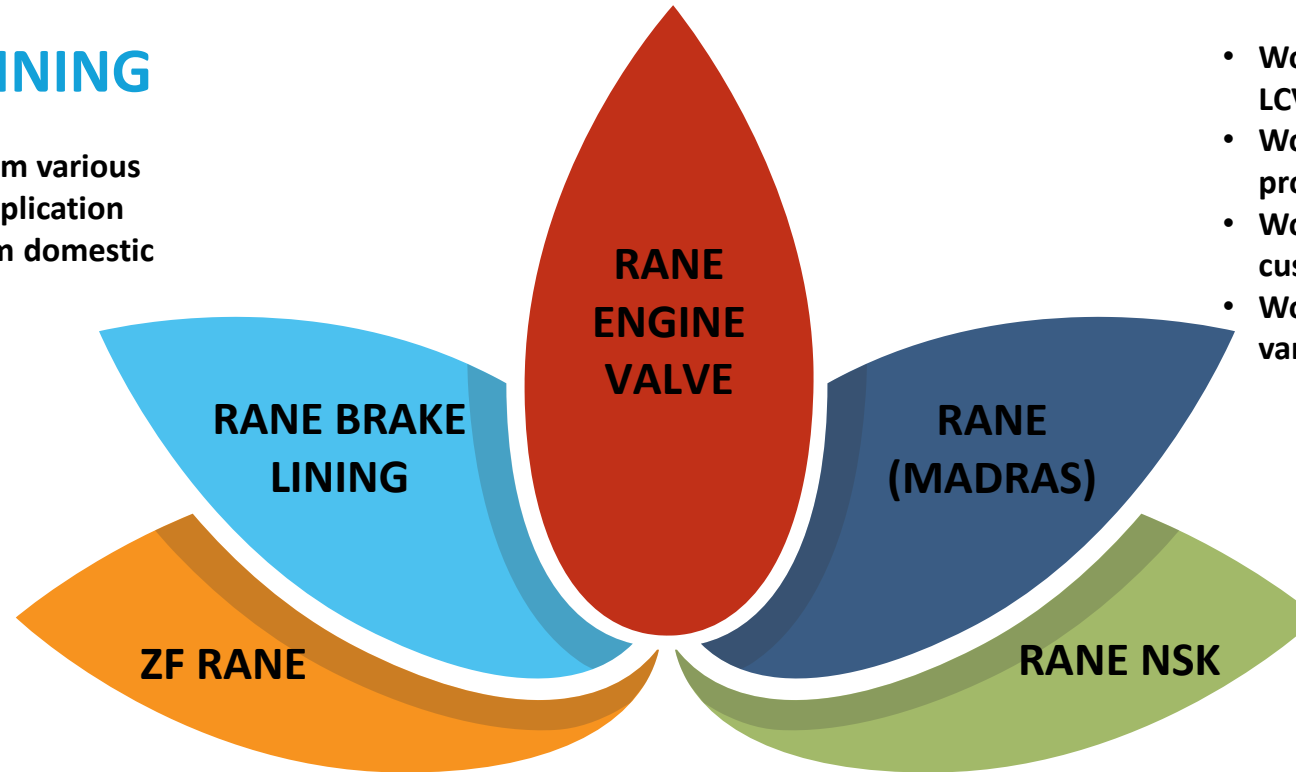

## ZF RANE

- Won orders worth Rs. 23 Cr for steering gear from various domestic CV customers including Rs. 3 Cr orders for EV application

## RANE ENGINE VALVE





- Won Rs. 5 Cr order from Domestic CV customer for CNG application

## RANE NSK

- Won new business worth Rs. 175 Cr for EPS from domestic customer for UV model

**During the quarter new business won of Rs. 320 Cr**

# We continue to target higher than the industry growth

Industry Performance Review (Q2 FY24)	 Passenger Vehicle	 commercial Vehicle	 Farm Tractor	 2-Wheeler
Production YoY Growth# in %	6%	9%	-10%	-2%
Rane Group Sales Growth YoY in % (India OEM)	18%	22%	-6%	15%
Rane Group Revenue Split * (India OEM)	62%	26%	6%	3%
	<ul style="list-style-type: none"> <li>Higher growth than the industry driven by new business and growth on served models in UV segment.</li> </ul>	<ul style="list-style-type: none"> <li>Higher share of business and higher growth with served models/customers</li> </ul>	<ul style="list-style-type: none"> <li>Performance is better than industry due to growth in served models</li> </ul>	<ul style="list-style-type: none"> <li>Better performance is driven by higher sales of friction material products</li> </ul>

\* Other segments such as Rail, Defence, Stationary Engines and 3-Wheeler contribute around 3%

## Market Commentary

- The growth in PV segment was driven by strong performance of new models in UV
- CV industry performance led by growth in M&HCV segment
- The drop in Farm tractor segment is due to decreased monsoon activity and subdued market sentiments.
- Demand from international markets remained favourable across product categories



# Group Aggregate Sales (Q2 FY24)

## Group Aggregate Sales (Rs cr.)

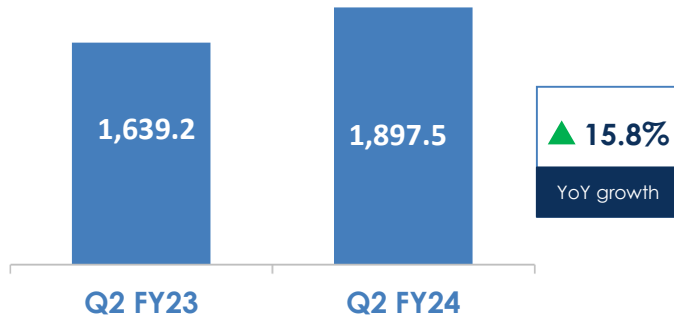

- › Sales increased by 15.8% from Rs. 1,639.2 Cr in Q2 FY23 to Rs. 1,897.5 Cr in Q2 FY24
- Revenue from Indian OE customers grew 16% supported by strong growth across vehicle segments
- Revenues from International customers increased 20% driven by higher off-take across steering, valve train, light metal casting and occupant safety products
- Revenue from Indian aftermarket segment increased by 5%

## Group Aggregate Sales (Q2 FY24)

### BY PRODUCT (%)

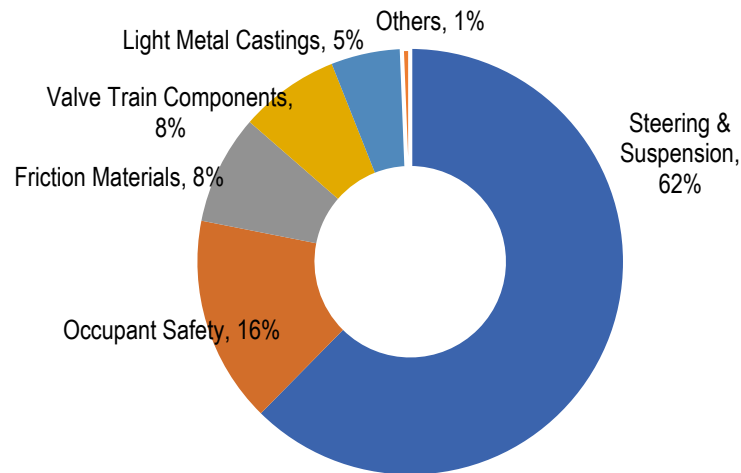

### BY MARKET (%)

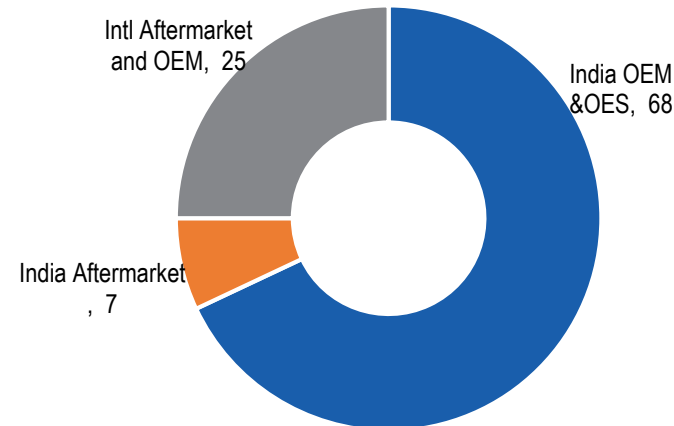

### BY VEHICLE SEGMENT (%)

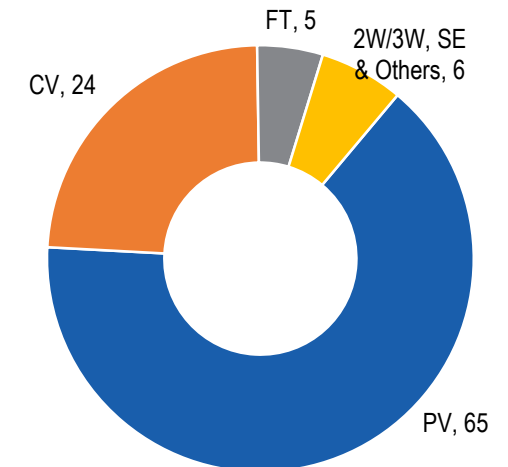

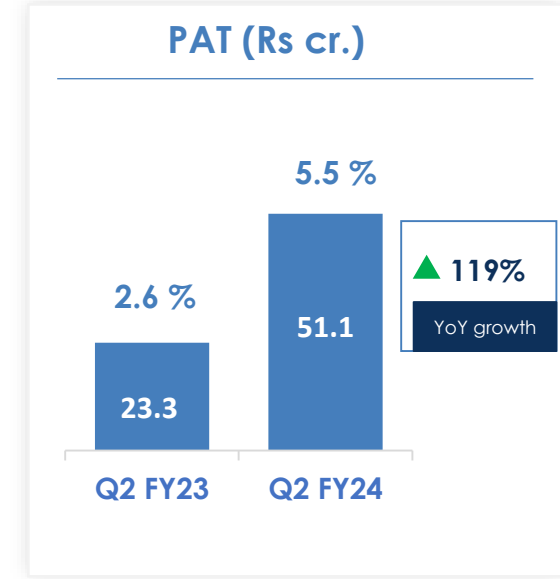
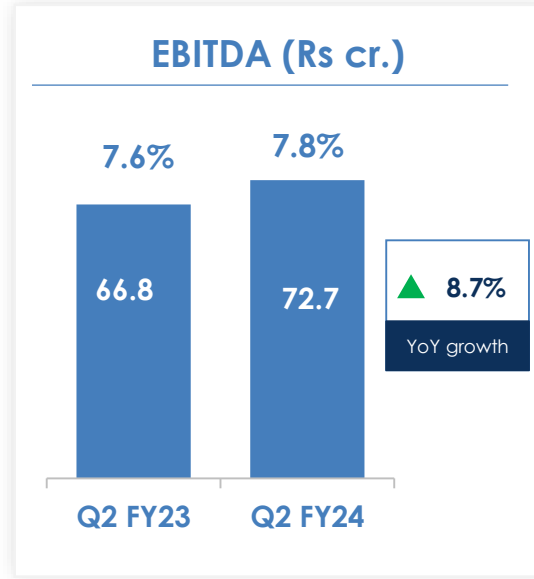
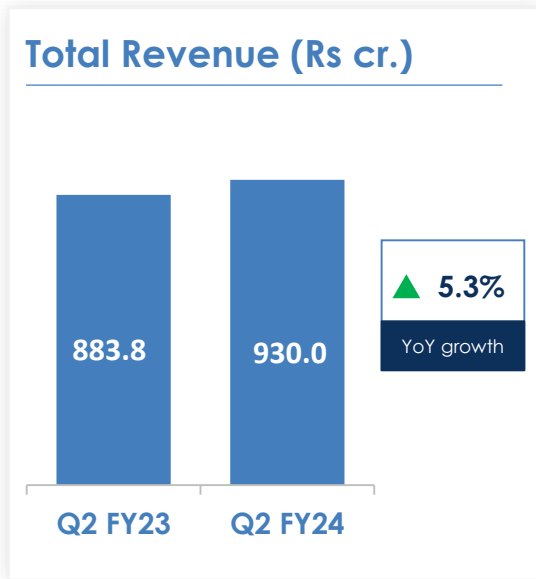

- › **Total Revenue increased by 5.3% from Rs. 883.8 Cr in Q2 FY23 to Rs. 930.0 Cr in Q2 FY24**
- › **EBITDA increased by 8.7% from Rs. 66.8 Cr in Q2 FY23 to Rs. 72.7 Cr in Q2 FY24**
- EBITDA margin increased 25 bps supported by lower material cost and improved operational performance.
- › **PAT increased by 119% from Rs.23.3 Cr in Q2 FY23 to Rs. 51.1 Cr in Q2 FY24**
- In Q2 FY'24: Recorded a loss on sale of LMCA for Rs. 85.5 Cr and also created a Deferred Tax Asset of Rs. 113.3 Cr.

# **Rane (Madras) Limited**

## **Q2 FY24 Financial & Operational Performance**

## Business Drivers

- › Slower growth for Steering division due to lower volume on served models in Indian market, however continues to have robust order pipeline
- › Higher volume and operational improvements on the Light Metal Castings India division

## Operational Highlights

- › Won “Supplier of Excellence” award from Polaris - US
- › Light Metal Castings India successfully started production and ramped up volume on a major export program for leading EV maker in US

## Business Split (Q2 FY24) – RML India

### BY MARKET (%)

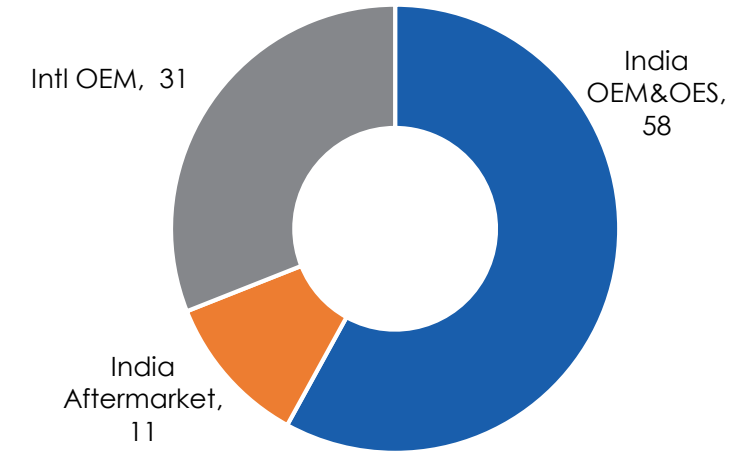

### BY VEHICLE SEGMENT (%)

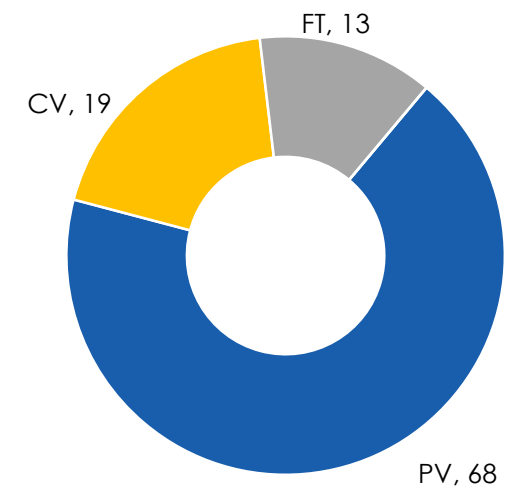

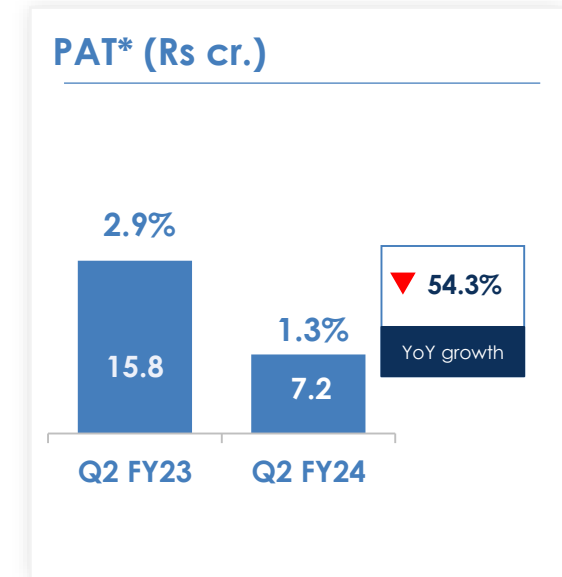
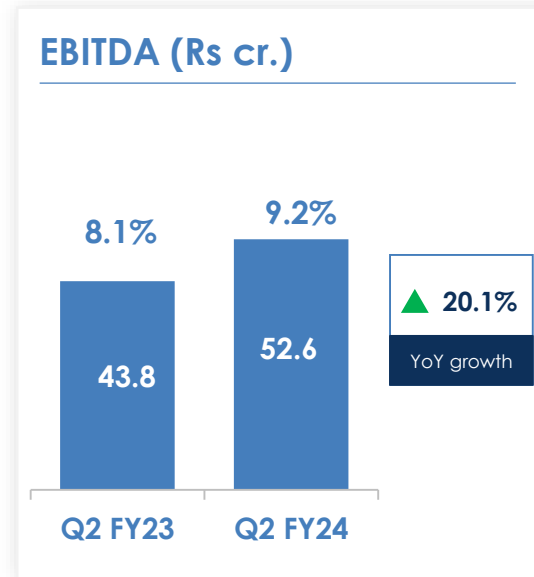
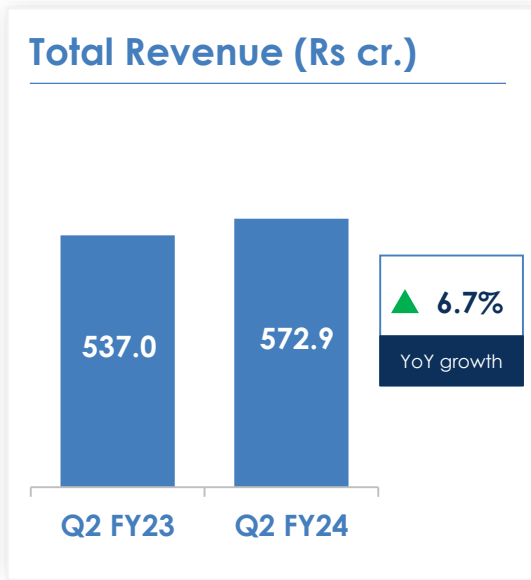

› **Total Revenue increased by 6.7% from Rs. 537.0 Cr in Q2 FY23 to Rs. 572.9 Cr in Q2 FY24**

- Sales to Indian OE customers dropped 2% due to decline in Farm Tractors segment and served segment de-growth in PV.
- Sales to International customers grew 31% driven by strong off-take for steering and light metal casting products.
- Sales to Indian Aftermarket customers increased by 7%.

› **EBITDA increased by 20.1% from Rs. 43.8 Cr in Q2 FY23 to Rs. 52.6 Cr in Q2 FY24**

- EBITDA margin increased by 103 bps supported by favourable mix which helped offset the higher employee costs.

› **PAT decreased by 54.3% from Rs. 15.8 Cr in Q2 FY23 to Rs. 7.2 Cr in Q2 FY24**

- In Q2 FY'24, recorded a fair value loss on overseas investment for Rs. 121.6 Cr and also created a Deferred Tax Asset of Rs. 113.3 Cr.

## Total Revenue (Rs cr.)

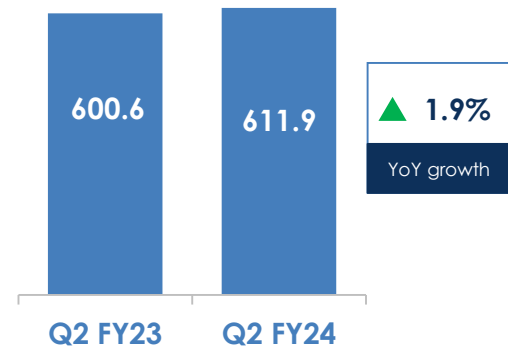

## EBITDA (Rs cr.)

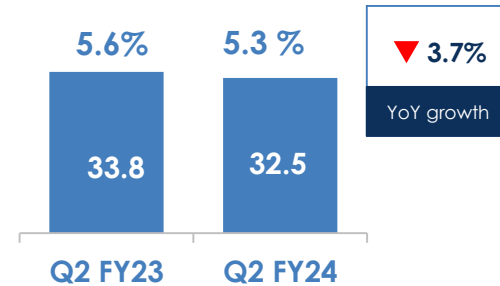

## PAT (Rs cr.)

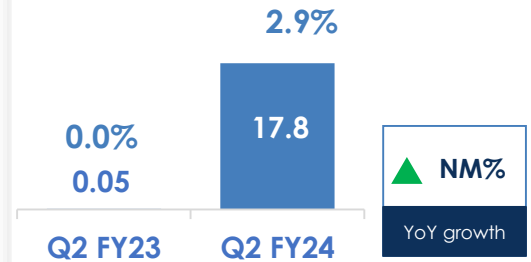

- › Total Revenue increased by 1.9% from Rs. 600.6 Cr in Q2 FY23 to Rs. 611.9 Cr in Q2 FY24
- › EBITDA decreased by 3.7% from Rs. 33.8 Cr in Q2 FY23 to Rs. 32.5 Cr in Q2 FY24
- › PAT increased from Rs. 0.05 Cr in Q2 FY23 to Rs. 17.8 Cr in Q2 FY24

— In Q2 FY'24, recorded a loss on sale of LMCA for Rs. 85.5 Cr and also created a Deferred Tax Asset of Rs. 113.3 Cr.

- › Divestment of its wholly owned subsidiary LMCA completed on 14<sup>th</sup> September 2023 and accordingly the company has consolidated the financial performance of LMCA till 14<sup>th</sup> September 2023.



# **Rane Engine Valve Limited**

## **Q2 FY24 Financial & Operational Performance**



## Business Drivers

- › 42% of revenue generated from EV insulated segment
- › Improved financial performance through
  - › Strong execution of orders
  - › Increasing mix of exports and EV insulated segment
  - › Operational improvement initiatives

## Operational Highlights

- › Trichy and Tumkur plants received TPM Certification from CII Institute of Quality

### Business Split (Q2 FY24)

#### BY MARKET (%)

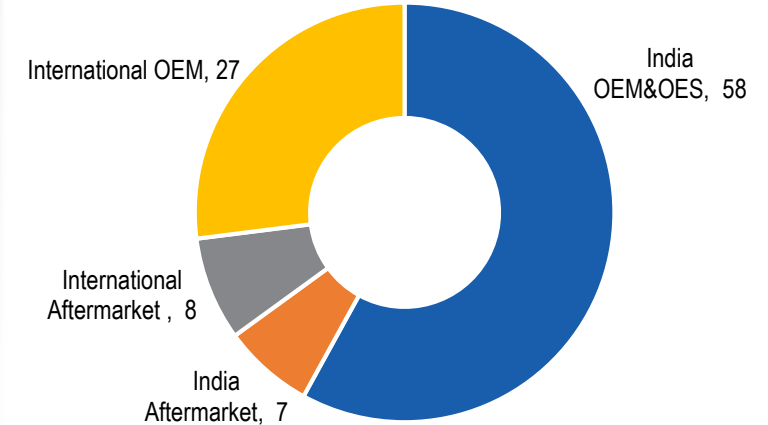

#### BY VEHICLE SEGMENT (%)

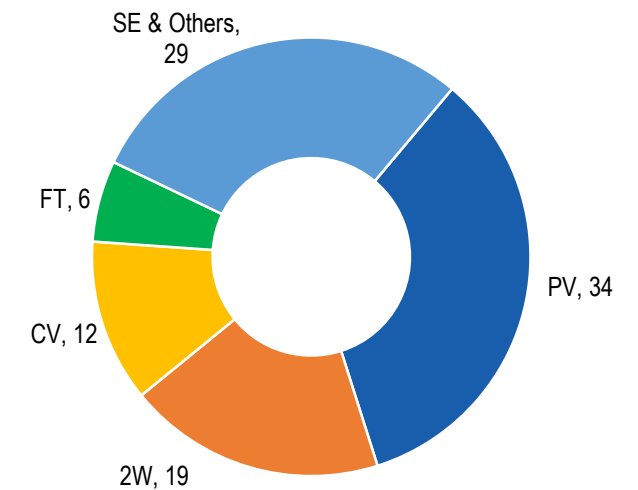



## Total Revenue (Rs cr.)

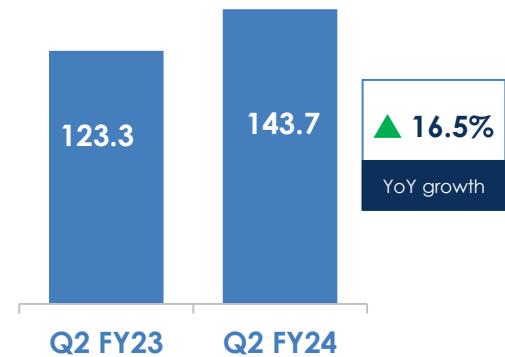

## EBITDA (Rs cr.)

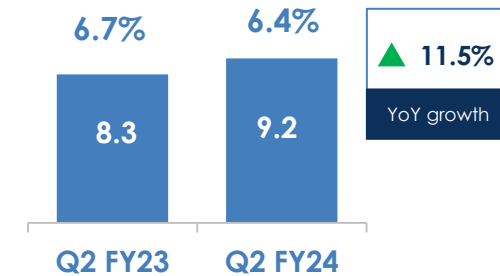

## PAT (Rs cr.)

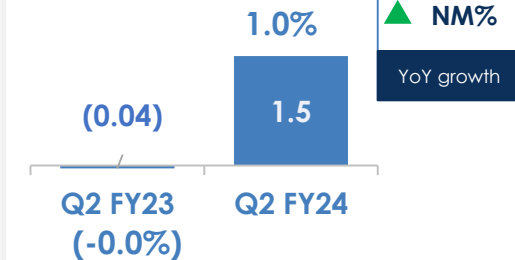

› **Total Revenue increased by 16.5 % from Rs. 123.3 Cr in Q2 FY23 to Rs. 143.7 Cr in Q2 FY24**

- Sales to Indian OE customers grew by 13% supported by strong offtake across served customers.
- Export Sales grew 25%. Demand from International customers remained strong.
- Sales to Indian Aftermarket customers grew by 14%.

› **EBITDA increased by 11.5% from Rs. 8.3 Cr in Q2 FY23 to Rs. 9.2 Cr in Q2 FY24**

- EBITDA margin declined by 29 bps. Better operational leverage was offset by higher employee cost

› **PAT increased from a Loss of Rs. 0.04 Cr in Q2 FY23 to a profit of Rs. 1.5 Cr in Q2 FY24**



# **Rane Brake Lining Limited**

## **Q2 FY24 Financial & Operational Performance**



## Business Drivers

- › Market leader in Passenger Vehicle segment and increased penetration in two wheeler segment
- › Strong presence in Aftermarket segment
- › Expanding the International Aftermarket segment

## Operational Highlights

- › Received “A” category rating from M&M and Mando.
- › Supplier performance rated as “Excellent” by HITACHI.
- › RBL – Puducherry won 1st Prize in ACMA National level QC competition.
- › RBL Puducherry won “Excellent Energy Efficient Unit” Award from CII

**Business Split (Q2 FY24)**  
**BY MARKET (%)**

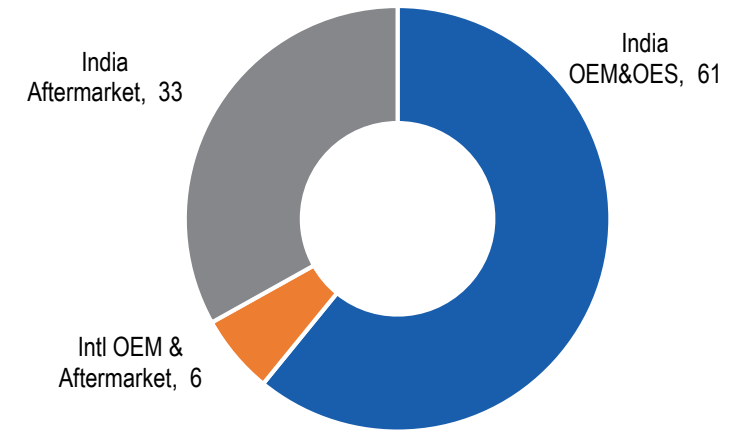

**BY VEHICLE SEGMENT (%)**

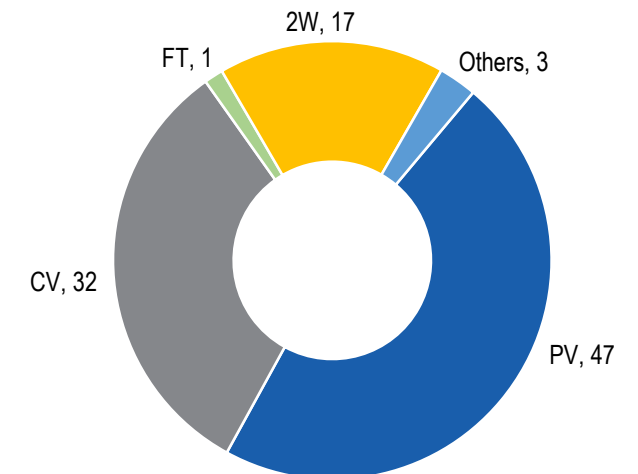

## Total Revenue (Rs cr.)



## EBITDA (Rs cr.)



## PAT (Rs cr.)



› **Total Revenue increased by 9.3% from Rs. 144.7 Cr in Q2 FY23 to Rs. 158.2 Cr in Q2 FY24**

- Sales to OE customer grew 13%, which was driven by strong sales to Two wheeler segment.
- Sales to Aftermarket customers grew 4%

› **EBITDA increased by 29.1% from Rs. 13.8 Cr in Q2 FY23 to Rs. 17.8 Cr in Q2 FY24**

- EBITDA margin improved by 172 bps on account of higher volume and one-off provision reversal during this quarter.

› **PAT increased by 48% from Rs. 6.5 Cr in Q2 FY23 to Rs. 9.6 Cr in Q2 FY24**



# **ZF Rane Automotive India Private Limited**

## **Q2 FY24 Financial & Operational Performance**



## Business Drivers

- › Strong growth in Commercial Vehicle segment drives growth of steering division
- › Occupant safety division benefits from increased preference for safer cars and sustained growth in exports

## Operational Highlights

- › Won Outstanding Contribution in Uptime Excellence Award from VECV

### Business Split (Q2 FY24)

#### BY MARKET (%)

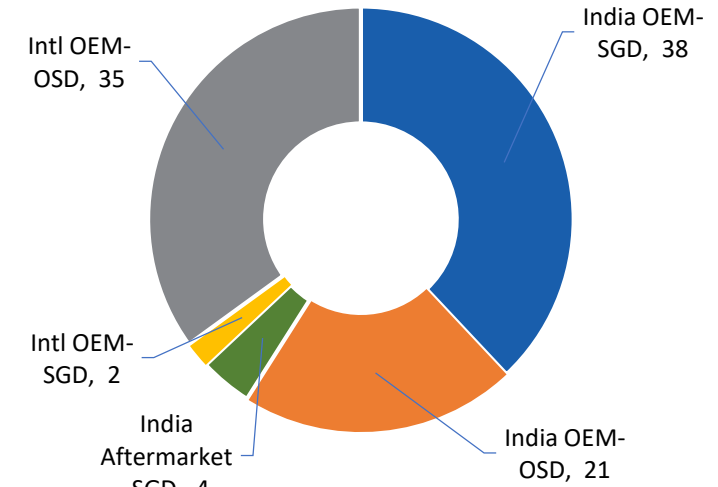

#### BY VEHICLE SEGMENT (%)

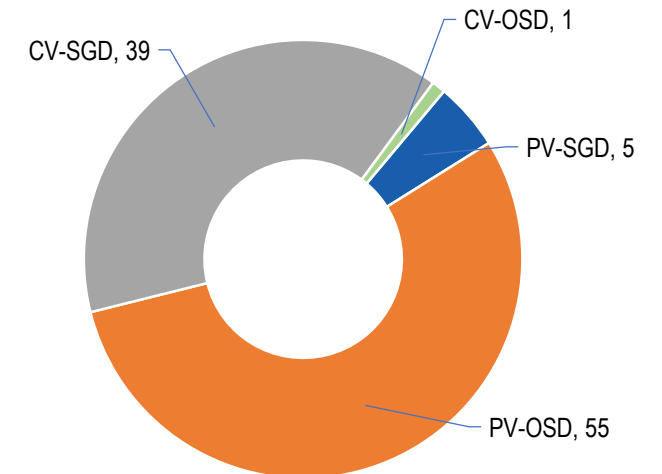

## Total Revenue (Rs cr.)

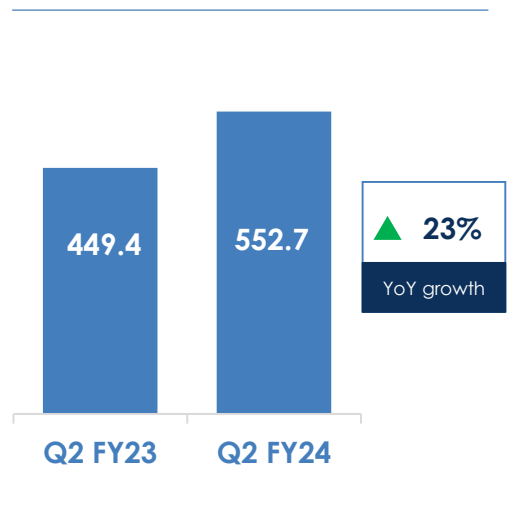

## EBITDA (Rs cr.)



## PAT (Rs cr.)



› **Total Revenue increased by 23% from Rs. 449.4 Cr in Q2 FY23 to Rs. 552.7 Cr in Q2 FY24**

- Revenue from steering gear products increased 20% supported by strong demand from commercial vehicle segment
- Revenue from occupant safety systems grew 27% supported by strong offtake from domestic and export customers

› **EBITDA increased by 16.9% from Rs. 46.6 Cr in Q2 FY23 to Rs. 54.4 Cr in Q2 FY24**

- EBITDA margin declined by 55 bps due to adverse mix.

› **PAT increased by 1.9% from Rs. 22.9 Cr in Q2 FY23 to Rs. 23.4 Cr in Q2 FY24**

# **Rane NSK Steering Systems Private Limited**

## **Q2 FY24 Financial & Operational Performance**



## Business Drivers

- › Favourable growth in served models with the key customer
- › Strong growth for Manual Steering Column product with new launches

## Operational Highlights

- › R&D Test Lab Facilities has been upgraded with State of Art machines for Testing & Research purposes.

## Business Split (Q2 FY24)

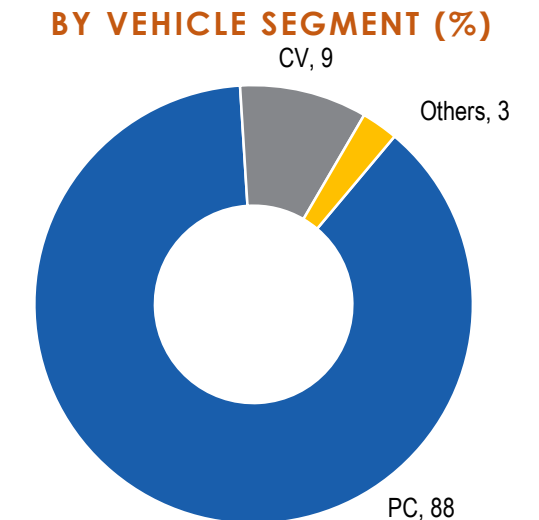
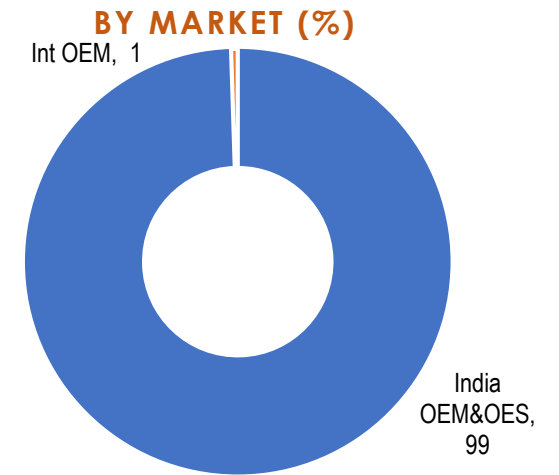

## Total Revenue (Rs cr.)

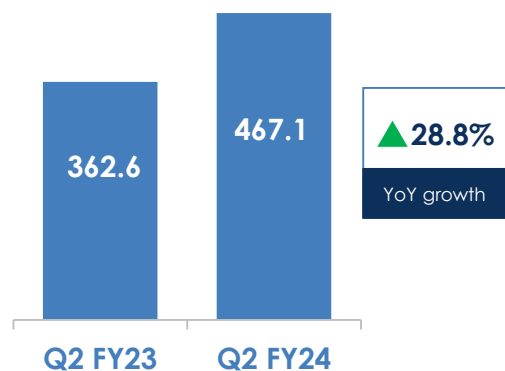

## EBITDA (Rs cr.)



## PAT (Rs cr.)

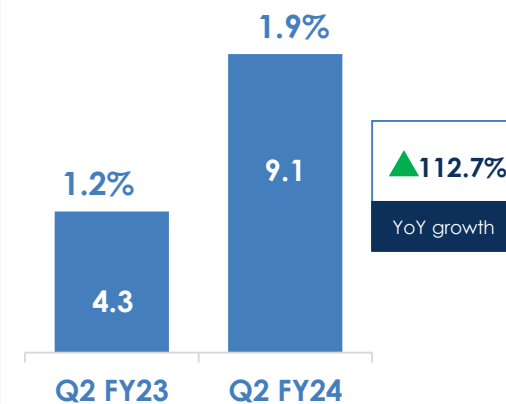

› **Total Revenue increased by 28.8% from Rs. 362.6 Cr in Q2 FY23 to Rs. 467.1 Cr in Q2 FY24**

— The growth in the quarter is on account of lower base due to EOP and higher growth on served models

› **EBITDA increased by 2.1% from Rs. 25.4 Cr in Q2 FY23 to Rs. 25.9 Cr in Q2 FY24**

— Adverse mix and increase in material cost impacted the profitability

› **PAT increased from Rs. 4.3 Cr in Q2 FY23 to Rs. 9.1 Cr in Q2 FY24**

— Exceptional income of Rs. 3 Cr towards sale of scrapped parts.



# Rane Group

## About Us



Founded in 1929 and headquartered in Chennai, Rane Group is one of the preferred OE manufacturer and supplier for global auto majors



The Group serves a variety of industry segments: Passenger Vehicles, Commercial Vehicles, Farm Tractors, Two-wheelers, Three-wheelers, Railways and Stationary Engines



Manufactures Steering and Suspension systems, Friction materials, Valve train components, Occupant safety systems and Light metal casting products.

REVENUE BY MARKET (%)

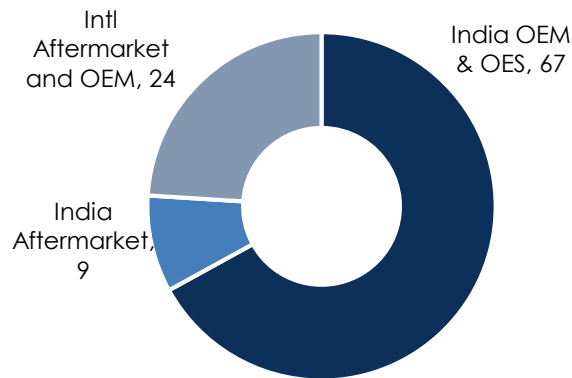

REVENUE BY VEHICLE SEGMENT (%)

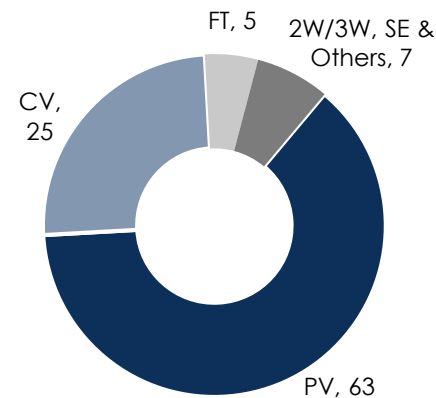

## GROUP SALES OF INR 6,690 CR (~USD 820 MN)

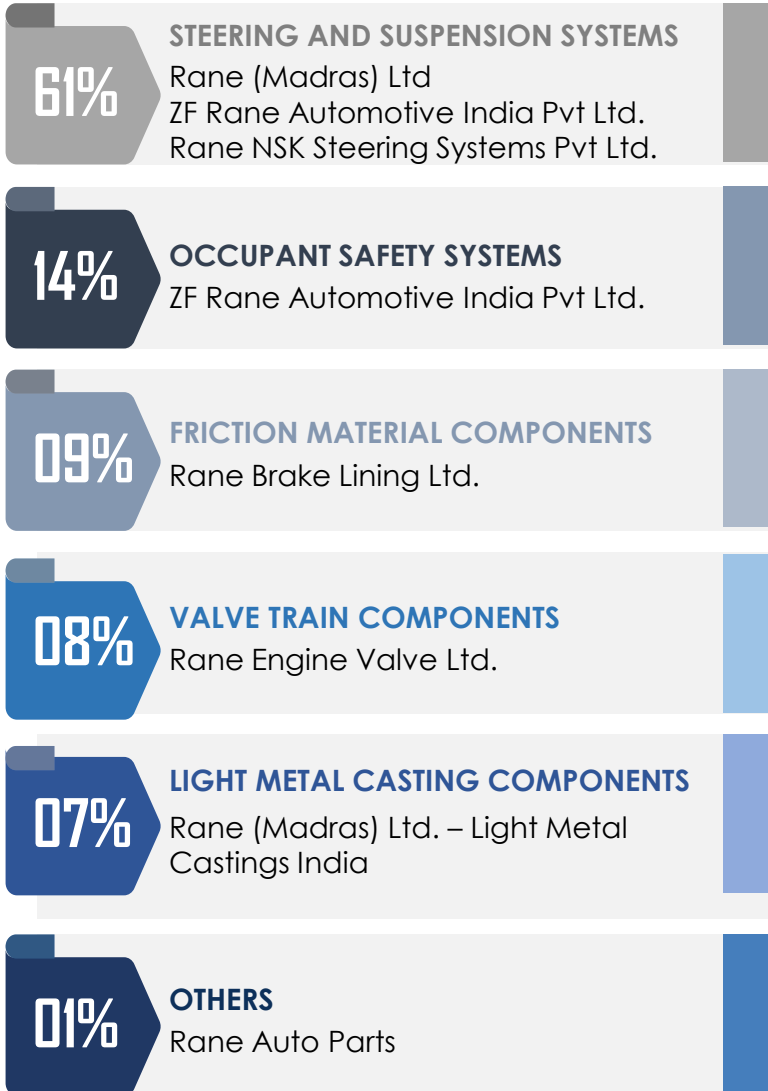

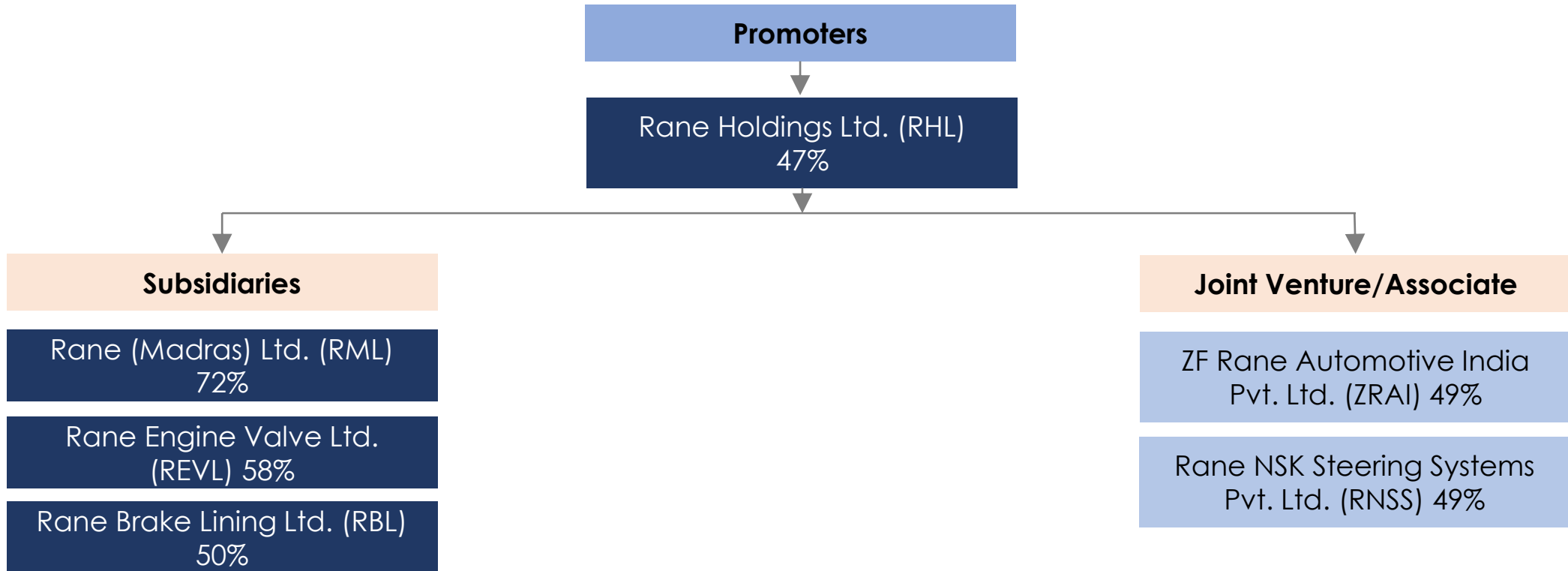

Listed

Share holding as on 30 September 2023

- Market leader in steering gear and steering linkage products in India. We have started catering to hydraulic products such as HSU and steering cylinders.
- Best in class manufacturing facilities at Chennai, Mysore, Puducherry and Pant Nagar.
- End to end testing facilities in house to validate the products' functional, endurance and environmental parameters.

## PRODUCTS

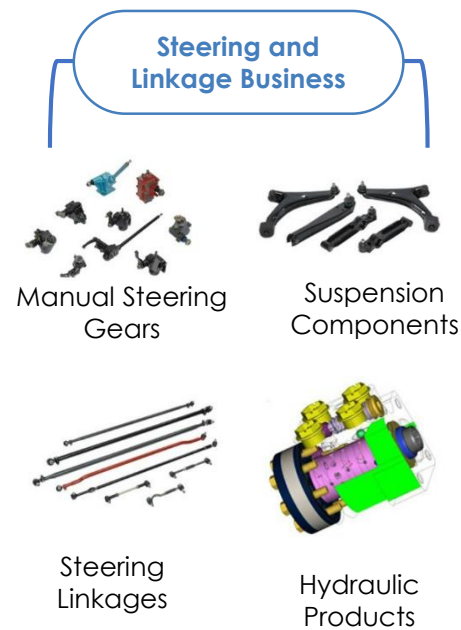

## MANUFACTURING PLANT

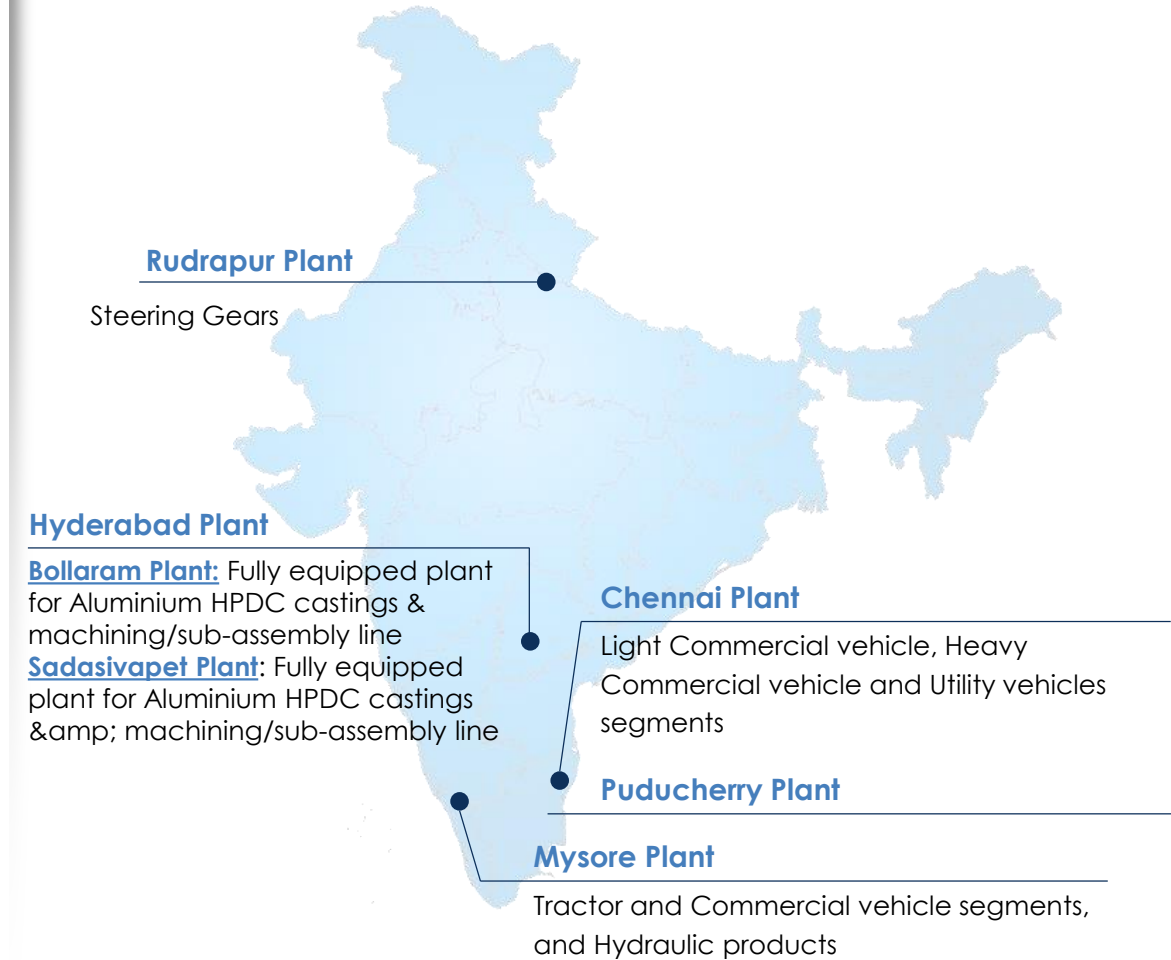

- Incepted In 1959, REVL manufactures valves and valve train components for various engine applications
- Non Automotive applications such as power generation, marine, defence, locomotive, etc.
- Comprehensive test laboratory for material characterisation, simulated test rigs and engine dynamometer test facility.

## PRODUCTS

Engine Valves



Valve Guides



Mechanical Tappets



## MANUFACTURING PLANT



### Hyderabad Plants (2)

Small Valves for 2W and PC  
Medium Valves for PC, Industrial and CV

### Tumakuru Plant

Medium Valves for CV and Farm Tractors  
Large & Extra Large Valves for Industrial, Power Generation and Marine Applications

### Chennai Plant

Small Valves for 2W and PC  
Medium Valves for Tractors and PC Guides, Tappets

### Trichy Plant

Small & medium Valves for 2W, PC and CV

- Established in 1964, RBL is a leader in Friction Products across OEM segments and supplies products to over 15 countries
- Technical collaboration with Nisshinbo Brakes Inc. and TMD Friction
- Library of widely tested and approved formulations to suit diverse market / customer requirements.
- State-of-the-art R&D center equipped with full scale inertia dynamometer, static mu-measurement and NVH study rig.

## PRODUCTS

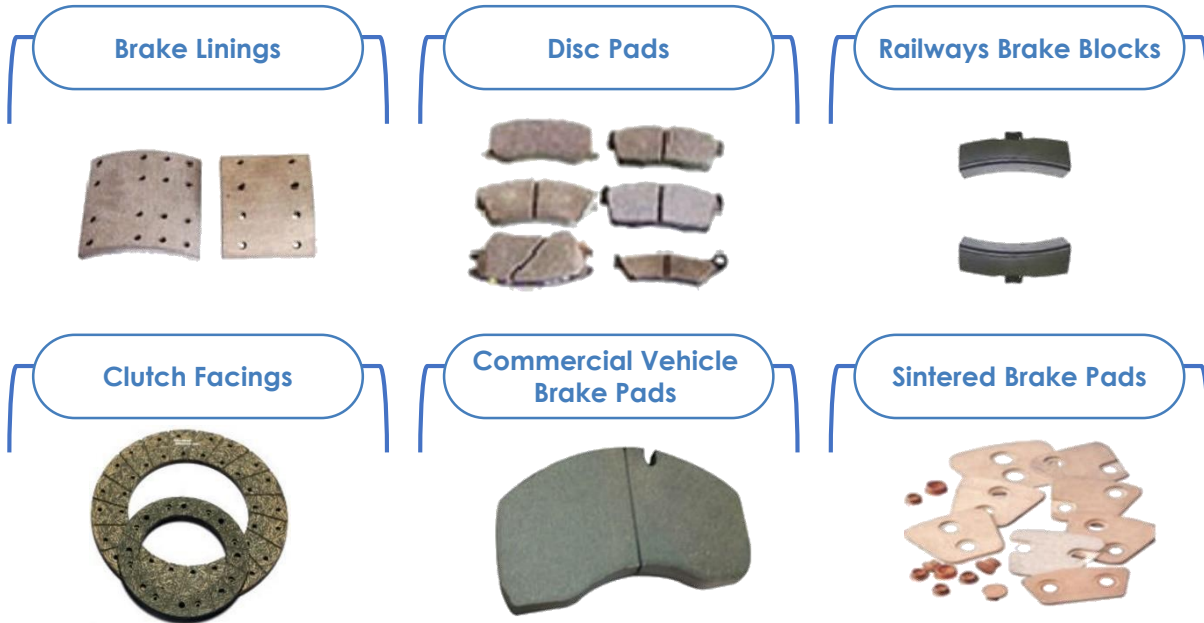

## MANUFACTURING PLANT

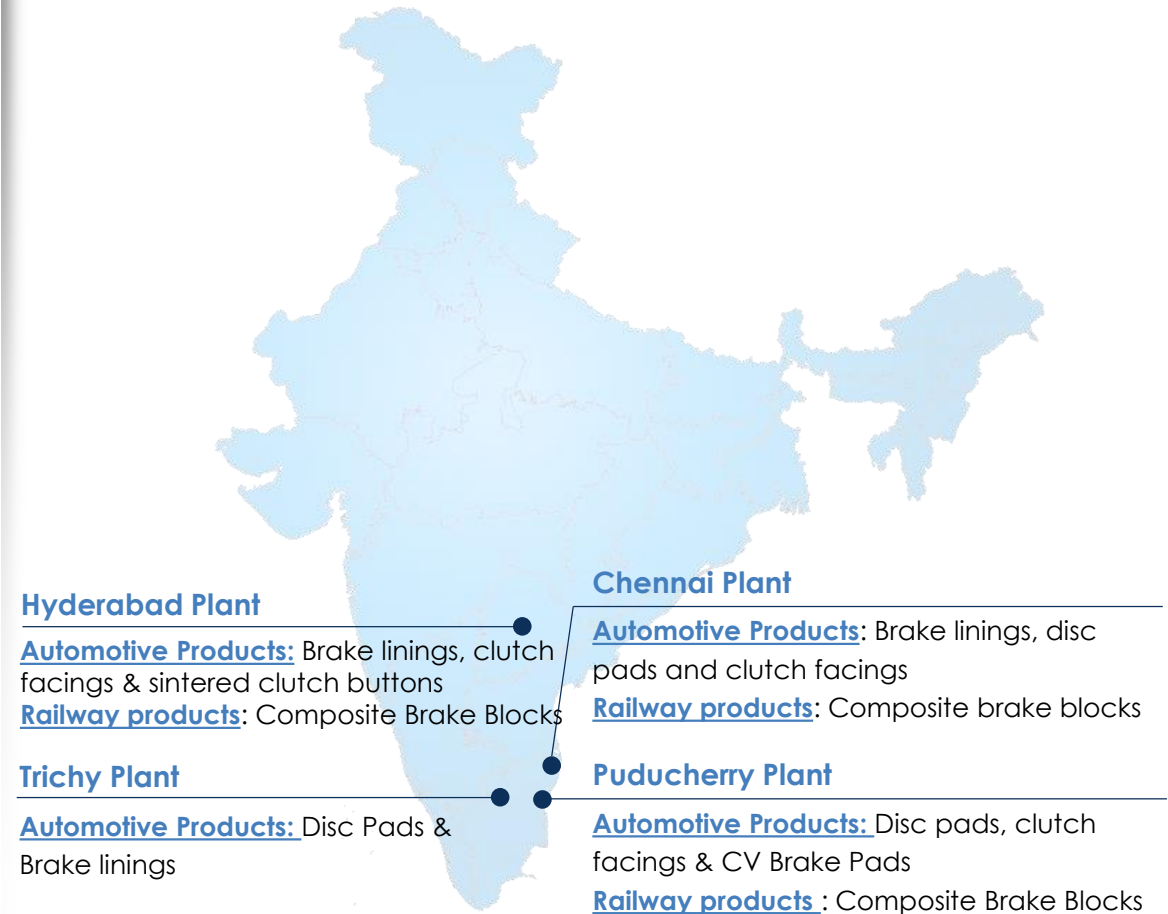



Joint venture partnership with ZF Group, Germany.

## Steering Gear Division

- Design, Development and Application capability for complete Hydraulic Power Steering system for all vehicles.
- Advanced design tools for 3D modeling, simulation, FE analysis and CFD.
- State-of-the-art testing facilities for strength, environment, noise, fatigue and durability tests to meet global standards

## Occupant Safety Division

- Product range includes different types of airbags and latest seatbelt technologies, Retractor and Anchor pretensioners, Emergency Locking Retractor (ELR), Load Limiters, Child Restraint Seat Belt, Driver Airbag, Passenger Airbag, Side Airbag and Curtain Airbags.
- Extensive testing facilities for seat belts include Extraction and Retraction Force Testing Machine, Retractor Durability Tester, Hot & Cold Chamber, Salt spray chamber, ELR functional tester.
- Equipped with Test lab to carry out testing as per National (IS/AIS), International (ECE/EEC/GS/VSCC), customer specifications and COP testing

## PRODUCTS

### Steering Gear Division



### Occupant Safety Division



## MANUFACTURING PLANT

### Rudrapur Plant

Steering Gears and Pumps

### Chennai Plant (4)

Pump and Power Rack & Pinion division, Occupant Safety Products

### Tiruchirapally Plant (2)

Fully integrated gear, Occupant Safety Products

- Joint venture partnership with NSK, Japan.
- State-of-art R&D test lab for validation of steering columns.
- Manufacturing facilities across four locations in Chennai, Bawal, Rudrapur & Ahmedabad.
- Design & Development capability for solid & energy absorbing columns. Development and application capability for EPS.
- Driver comfort, Passenger safety, Ergonomics and NVH requirements are kept as targets while designing steering system.
- Comprehensive test laboratory for extensive research about column performance characteristic validation, strength and durability validation and NVH requirements.
- Design team includes CAD & CAM application experts and software analysts.

## PRODUCTS



## MANUFACTURING PLANT

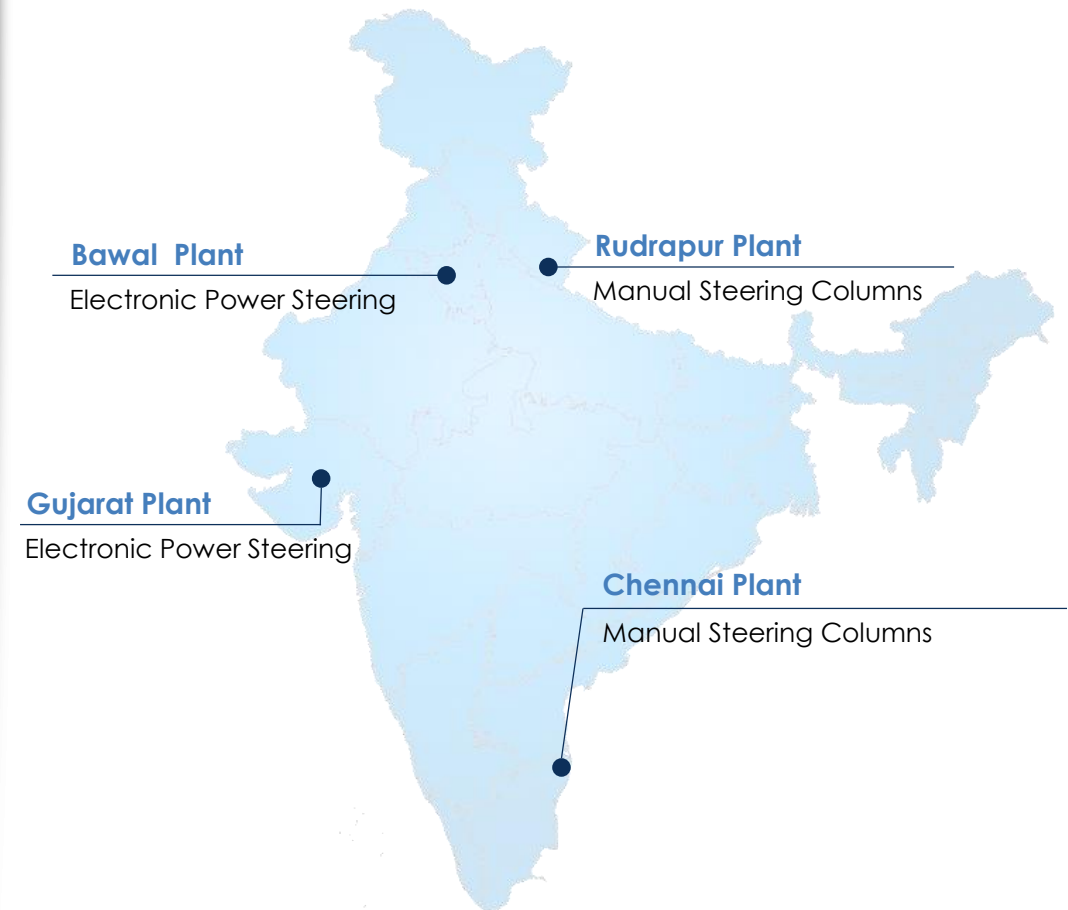

## Light Metal Casting Products

Pinion Housing

Engine Timing Case Cover

Outboard Housing

## Valve train Components

Engine Valves

## Occupant Safety Systems

Seat Belts

Airbags

## Friction Materials

Brake Lining

Disc Pad

Upper Control Arm

Stabilizer Link

Lower Control Arm

## Steering & Suspension Systems

Suspension Ball Joint

Outer Ball Joint

Inner Ball Joint

Power Steering Pump

Rack & Pinion steering gear  
-Mechanical  
-Hydraulic

Electric Power Steering Columns

### Rane (Madras)

- › Manual Steering Gears
- › Steering Linkages
- › Suspension Components
- › Light Metal Casting Products

### Rane Engine Valve

- › Engine Valves

### Rane Brake Lining

- › Brake Linings
- › Disc Pads

### Rane NSK Steering Systems

- › Electric Power Steering Systems

### ZF Rane Automotive India Pvt Ltd.

- › Hydraulic Power Steering systems
- › Seat Belts
- › Airbags

## Steering & Suspension Systems



Manual Steering Column



Power Steering Gear



Power Steering Pump



Manual RCB Steering Gear



Drag Link Assembly



Tie Rod Assembly

Hydraulic Cylinder (Twin/multi front axle trucks)



## Light Metal Casting Products

Hydraulic Pump Housing



## Occupant Safety Systems

Seat Belts



## Friction Materials

Brake Lining



Disc Pad



## Valve train Components

Valve Guides



Engine Valves

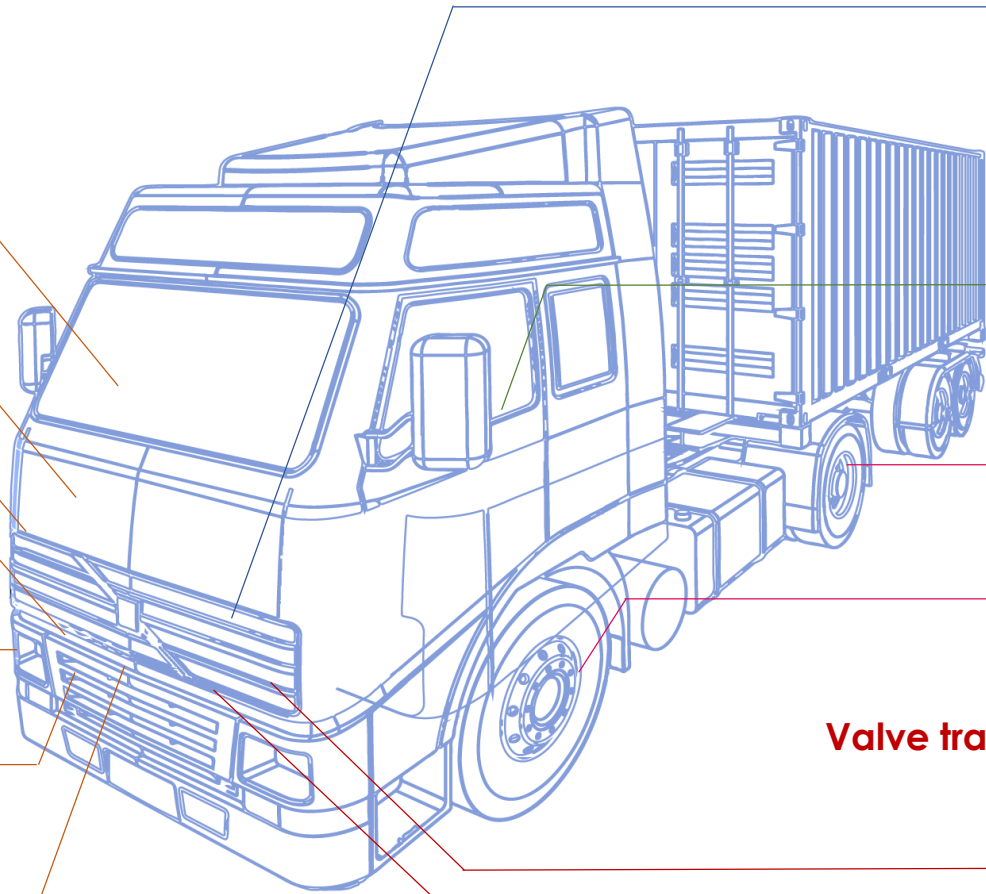

### Rane (Madras)

- › Manual Steering Gears
- › Steering Linkages
- › Hydraulic Cylinders
- › Light Metal Casting Products

### Rane Engine Valve

- › Engine Valves
- › Valve Guides

### Rane Brake Lining

- › Brake Linings
- › Brake Pads

### Rane NSK Steering Systems

- › Manual Steering Column

### ZF Rane Automotive India Pvt Ltd.

- › Hydraulic Power Steering Systems
- › Seat Belts

## Steering & Suspension Systems



Manual Steering /  
Column  
Manual RCB  
Steering Gear



Hydrostatic  
Steering Unit



Power Steering  
Gear



Drag Link Assembly



Tie Rod Assembly

Hydraulic  
Cylinder



## Friction Materials

Clutch Facings



Brake Lining

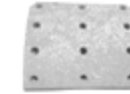

## Light Metal Casting Products

Timing Case Covers



Seat Belts



## Valve train components

Valve Guides



Engine Valves



### Rane (Madras)

- › Manual Steering Gears
- › Steering Linkages
- › Hydraulic Cylinders
- › Hydrostatic Steering Unit
- › Light Metal Casting Products

### Rane Engine Valve

- › Engine Valves
- › Valve Guides

### Rane Brake Lining

- › Brake Linings
- › Clutch Facings

### Rane NSK Steering Systems

- › Manual Steering Column

### ZF Rane Automotive India Pvt Ltd.

- › Hydraulic Power Steering systems
- › Seat Belts



## Light Metal Casting Products

### Battery Box & Cover

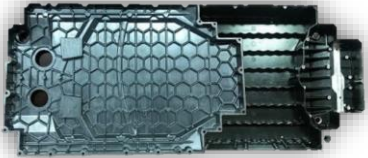

## Friction Materials

### Disc pad

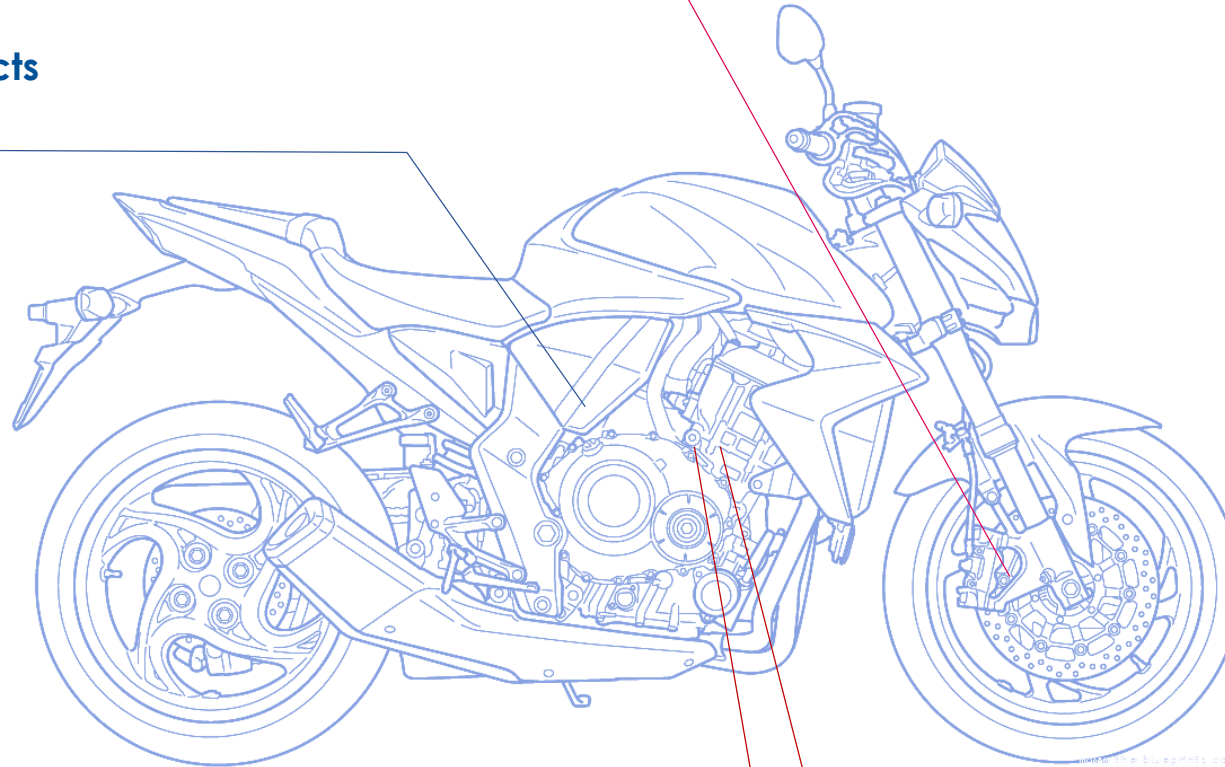

### Rane (Madras)

- › Light Metal Casting Products

### Rane Brake Lining

- › Disc Pads

### Rane Engine Valve

- › Engine Valves
- › Valve Guides

## Valve train Components

### Valve Guides



### Engine Valves



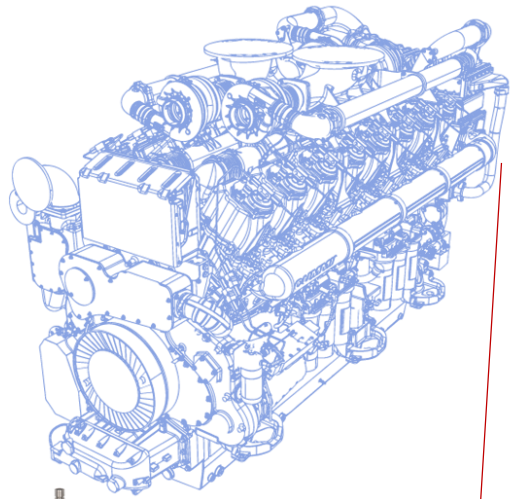

**Engine Valves / Valve Guides**

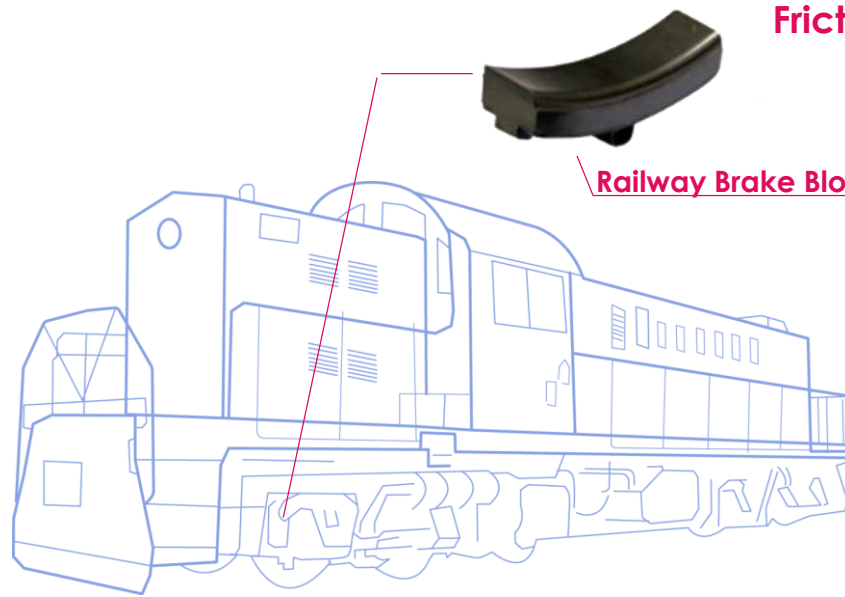
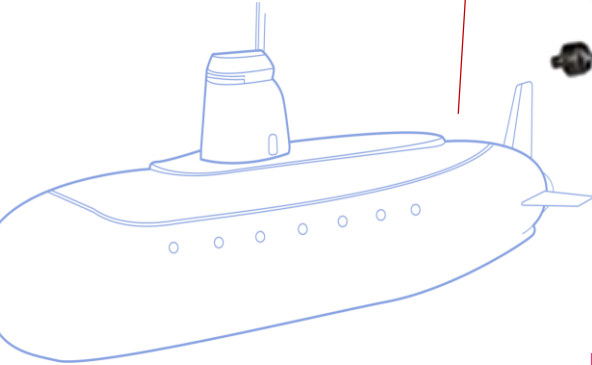

**Railway Brake Block**

**Friction Materials**



**Sintered Brake Pads**

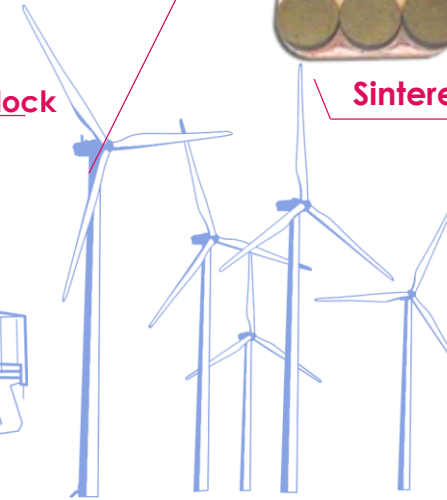

**Suspension Ball Joint**

**Outer Ball Joint**

**Inner Ball Joint**

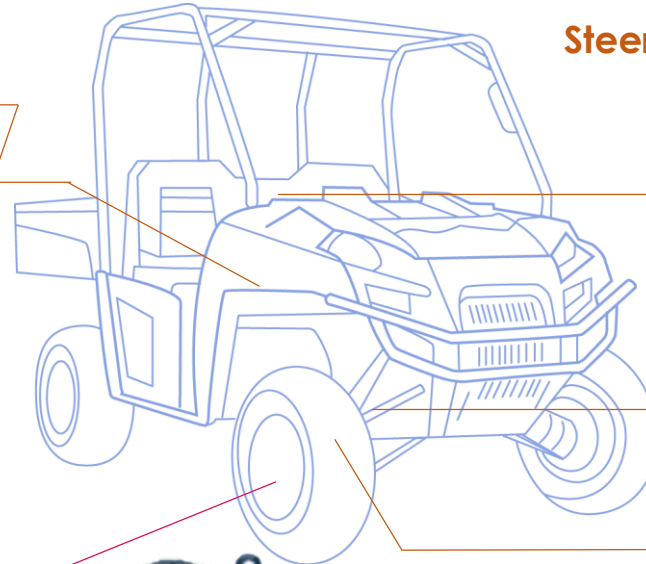

**Steering & Suspension Systems**



**Steering Shafts**



**Rack & Pinion steering gear -Mechanical**



**Stabilizer link**

**Friction Materials**  
**Disc pad**



**Rane (Madras)**

- › Manual Steering Gears
- › Steering Linkages
- › Light Metal Casting Products

**Rane Engine Valve**

- › Engine Valves
- › Valve Guides

**Rane Brake Lining**

- › Sintered Brake Pads
- › Railway Brake Block

**Rane NSK Steering Systems**

- › Steering Shafts

An illustrious journey of over 80 years from distributor of automobile and auto components to winner of Deming prize for manufacturing

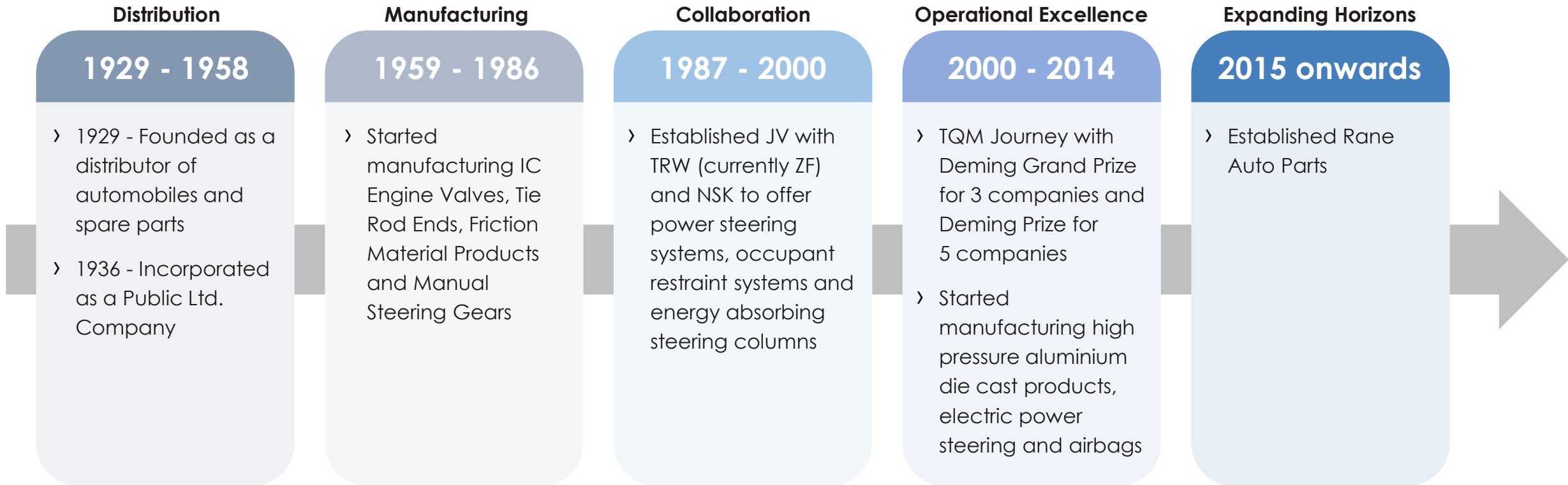





**30+** Serve customers in 30+ countries

**26** Manufacturing locations across India

Customer Locations   Manufacturing Locations   Sales Offices

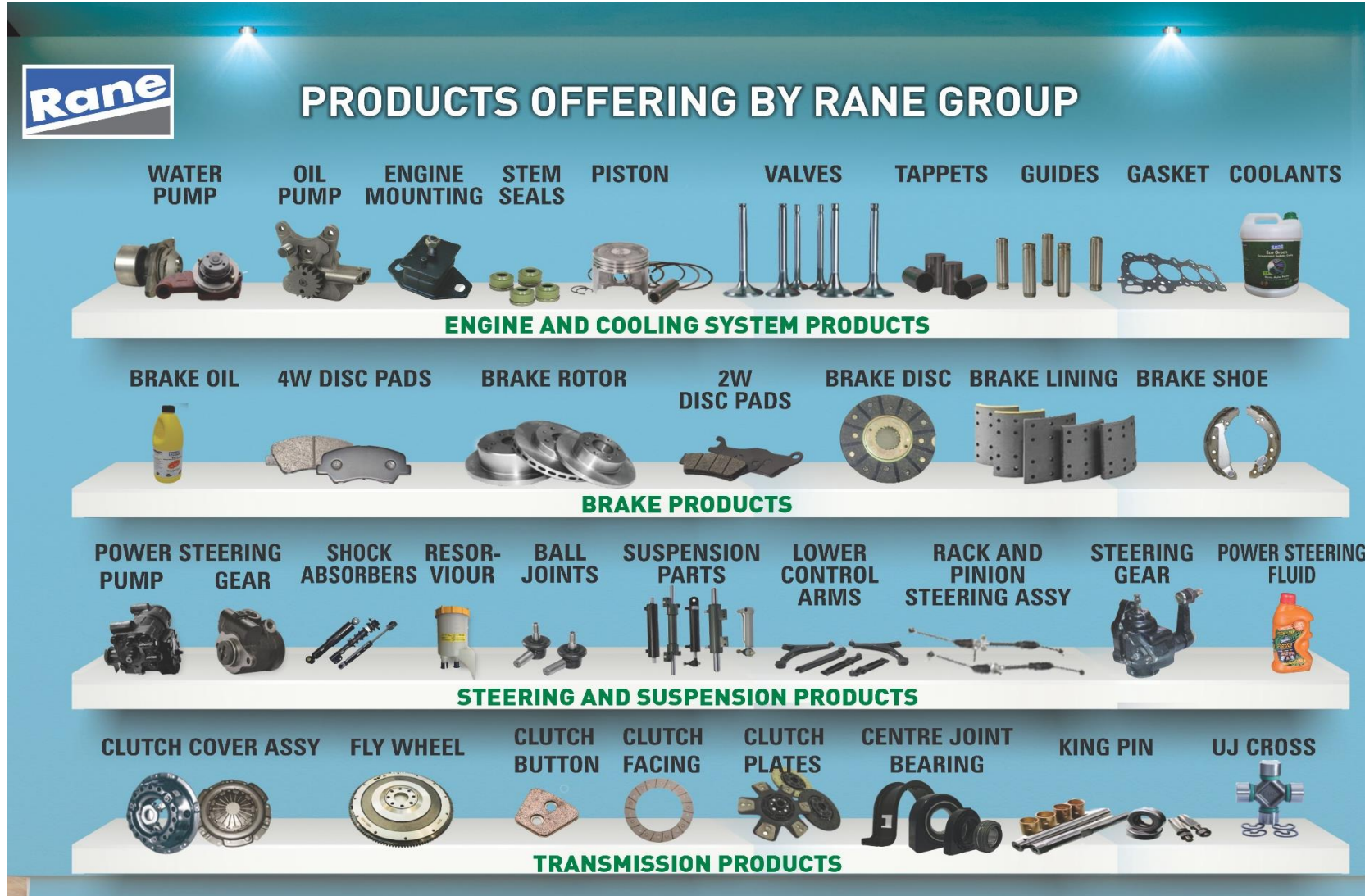

Increasing Group's brand presence in aftermarket through enhanced product portfolio and wider market reach

## Strong CAE Capabilities – Design, Analysis & Simulation Software

**230** R&D Engineers

**42** Functional Test Rigs

**26** Strength Test Rigs

**62** Durability Test Rigs

**33** Environmental Test Rigs

**10** Noise Test Rigs



Hydraulic Power Steering Systems and Occupant Safety Systems



Energy Absorbing Steering Columns and Electric Power Steering



Brake Linings, Discs Pads and Clutch Facings



We create and deliver value to our customers

Passenger Vehicle



Commercial Vehicle



Farm Tractor



Two/Three-Wheeler



Other Applications



INDIA



INTERNATIONAL

‘Customer at the core’ remains our priority on the goal to sustainable growth and profitability



## Rane Group

Customer	Award Category
<b>Mahindra &amp; Mahindra</b>	Business Partner of the year – Automotive Division
<b>Ki Mobility Solutions</b>	Partnership of Excellence



## Rane (Madras)

Customer	Award Category
<b>Volvo Eicher</b>	New Product Development Award
<b>Nexteer TAFE</b>	Perfect Quality Award Best Supplier & Benchmark Award
<b>Maruti Suzuki</b>	Superior Performance Award, Special Support
<b>SML Isuzu</b>	New Product Development Award
<b>Tata Motors</b>	Award for Exceptional Support, Best Supplier – Demand Fulfillment
<b>Toyota Industries</b>	Best Target Achieved Supplier Award
<b>Polaris</b>	Supplier of Excellence
<b>Daimler India</b>	Reliable Partner & Achieving 100% in delivery



## Rane Engine Valve

Customer	Award Category
<b>Groupe Renault</b>	Quality & Customer Satisfaction
<b>John Deere India</b>	Quality Appreciation Award
<b>Volvo Eicher</b>	Quality & Delivery excellence
<b>Renault Nissan</b>	Quality & Customer Satisfaction
<b>Hyundai</b>	Appreciation Award
<b>Cummins India</b>	Superior Quality Award



## ZF Rane

Customer	Award Category
<b>Ashok Leyland</b>	Best Performance in Business Alignment-Gold
<b>Isuzu Motors</b>	Most Improved Supplier Award
<b>Tata Motors</b>	Best Supplier Award, Efficiency Award, Best in Class Award
<b>Volvo Eicher</b>	Best Supplier in NPD, Supply Chain, Uptime Excellence
<b>Daimler India</b>	Quality Appreciation Award
<b>Renault Nissan</b>	Best Supplier in Field Quality



## Rane Brake Lining

Customer	Award Category
<b>Brakes India</b>	Best Supplier - Friction
<b>Ashok Leyland</b>	After Market Support Award
<b>Foundation Brake</b>	Business Excellence Award
<b>Endurance</b>	Gold Award for Quality Best Benchmark Award, Best Supplier Award, Consistent Vendor Rating Performance Award



## Rane NSK

Customer	Award Category
<b>Maruti Suzuki</b>	Efforts in Vendor Import Localisation
<b>Honda Cars</b>	Award for best reduction in CO2
<b>Volvo Eicher</b>	Quality Excellence
<b>Daimler India</b>	Best Technology Support

## Rane Values

- › Provide superior products and maintain market leadership
- › Pursue excellence
- › Achieve the highest standard of ethics and integrity

## Rane Approach

- › Build strong connections with customers to understand their challenges
- › Strategic investments to improve quality and productivity
- › TQM way of working
- › Emphasis on 'First-time right' policy

## Rane Credentials

- › Modern manufacturing facilities with IATF 16949 certification
- › State-of-the-art product development and validation capabilities
- › Deming Grand Prize for 3 Rane companies
- › Deming Prize for 5 Rane companies



- › Technology collaboration with top global players



ZF Group, Germany  
Hydraulic Power Steering Systems and Occupant Safety Systems



NSK, Japan  
Energy Absorbing Steering Columns and Electric Power Steering



Nisshinbo Brake Inc., Japan  
Brake Linings, Disc Pads and Clutch Facings

## Value Proposition

- › Superior products driven by execution excellence
- › Trusted partner with shorter development lead times
- › Agile manufacturing process and scalable facilities
- › Provide system-level solutions with deep understanding of customer needs
- › With enhanced R&D capabilities, we provide light-weighting, improved safety and performance

**LONG TERM PARTNER OF CHOICE TO LEADING  
AUTOMOTIVE COMPANIES AND TIER 1 SUPPLIERS**

An exciting workplace founded on the principles of values, fairness and transparency that:



Provides challenging assignments

Encourages learning

Enhances career opportunities



- › **Organisation Development Excellence Award** for the exceptional practices on **Leadership Development** by Transcendence, Tata Institute of Social Sciences (TISS), 2019
- › Recognized by International Federation of Training and Development Organizations in Best HRD practice category, 2018
- › Award for **Talent Management** from the Employer Branding institute, Singapore, 2012 & 2014
- › Significant Achievement in **HR Excellence**, CII, 2012



Certified as a **Great Workplace** by the Great Place to Work institute, 2023



## Systems approach to deliver H&S to our employees

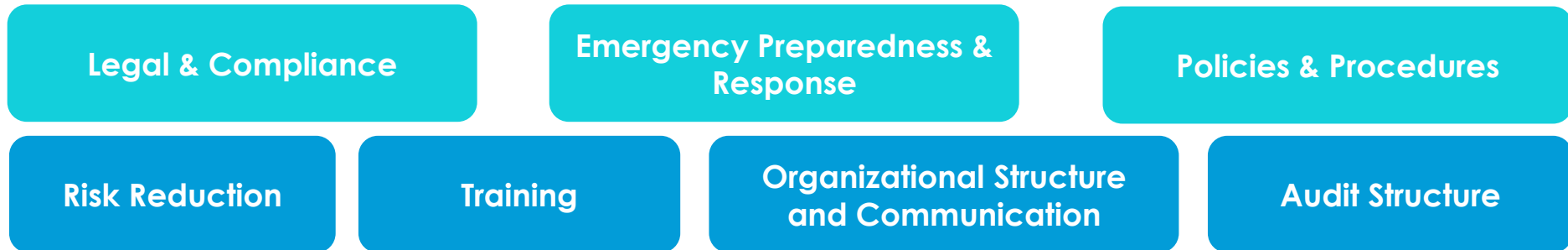



- › Rane Foundation (RF) is a **public charitable trust** founded by Rane's promoters in the year 1967
- › RF is the **main arm for Rane's Corporate Social Responsibility (CSR) initiatives** and is exclusively funded by the Rane companies
- › Initiatives are focused on **education, healthcare, environment and community development**

## Rane Polytechnic



### Education

- › Institution Development - Rane Polytechnic, Rane Vidyalaya
- › Vocational Training & Skill Development
- › Awareness programs



### Healthcare

- › Nutrition program
- › Health camps
- › Medical infrastructure & aid



### Environment

- › Plantation drives
- › Infrastructure for sustainability
- › Natural resource preservation



### Community Development

- › Providing amenities & sanitation
- › Improving quality of life
- › Rural infrastructure development program

## Rane Vidyalaya





# Thank You

For further information, please contact:

[investorservices@ranegroup.com](mailto:investorservices@ranegroup.com) or [diwakar.pingle@in.ey.com](mailto:diwakar.pingle@in.ey.com)

## **Rane Corporate Centre**

"Maithri" 132, Cathedral Road,  
Chennai - 600 086, India  
[www.ranegroup.com](http://www.ranegroup.com)

## Glossary of Abbreviations

Abbreviation	Expansion	Abbreviation	Expansion
ACMA	Automotive Component Manufacturers Association	OE	Original Equipment
AMP	Advanced Machining Processes	OEM	Original Equipment Manufacturer
bps	Basis point, 100 bps equal to 1%	OES	Original Equipment Supplier
BV	Book Value per share	OSD	Occupancy Safety Division
CII	Confederation of Indian Industry	PC	Passenger Car
CNG	Compressed Natural Gas	PV	Passenger vehicle
Cr	Crores	R&D	Research and development
CV	Commercial Vehicle	RBL	Rane Brake Lining Limited
ELR	Emergency Locking Retractor	REVL	Rane Engine Valve Limited
EPS	Earnings per share / Electronic power steering	RHL	Rane Holdings Limited
EV	Electric vehicle	RML	Rane (Madras) Limited
FT	Farm Tractors	RNSS	Rane NSK Steering Systems Pvt Limited
FY	Financial Year	SCV	Small Commercial vehicle
HPDC	High Pressure Die Casting	SE	Station Engine
HR	Human Resource	SGD	Steering Gear Division
Intl	International	TPM	Total Productive Maintenance
JV	Joint Venture	US	United States
LCV	Light Commercial Vehicles	USD	United States Dollar
LMCA	Light Metal Casting Inc., America	UV	Utility Vehicle
Ltd	Limited	VRS	Voluntary Retirement Scheme
M&HCV	Medium & Heavy Commercial Vehicles	YoY	Year-on-Year
M&M	Mahindra and Mahindra	ZRAI	ZF Rane Automotive India Pvt limited
NPD	New Product Development	2W/3W/4W	Two Wheeler/Three Wheeler/Four Wheeler

*This presentation may contain certain forward looking statements concerning Rane's future business prospects and business profitability, which are subject to a number of risks and uncertainties and the actual results could materially differ from those in such forward looking statements. The risks and uncertainties relating to these statements include, but not limited to risks and uncertainties regarding fluctuations in earnings, our ability to manage growth, competition (both domestic and international), economic growth in India and the target countries for exports, ability to attract and retain highly skilled professionals, government policies and action with respect to investments, fiscal deficits, regulations etc., interest and other fiscal costs generally prevailing in the economy. The company does not undertake to make any announcement in case any of these forward looking statement become materially incorrect in future or update any forward looking statements made from time to time by or on behalf of the Company.*