



Date: 21-11-2024

**BSE Limited
Department of Corporate Services,
P. J. Towers, Dalal Street,
Mumbai - 400 001
Scrip Code: 544244**

**National Stock Exchange of India Limited
Exchange Plaza, 5th Floor, Plot No. C/1, G
Block, Bandra Kurla Complex, Bandra (East),
Mumbai – 400 051
Scrip Name: GALAPREC**

Dear Sir/Ma'am,

Sub: Investor Presentation for the period ended September 30, 2024

In terms of Regulation 30 of the SEBI (Listing Obligation and Disclosure Requirements) Regulations, 2015, (as amended) we submit herewith a copy of Investors Presentation with respect to Business Overview for the Quarter and half year ended September 30, 2024, of Gala Precision Engineering Limited (“the Company”).

Further a copy of the same is also available on the website of the Company viz. www.galagroup.com.

Please take the same on your records.

Thanks & Regards,
For Gala Precision Engineering Limited

**Pooja Ladha
Company Secretary and Compliance Officer
Encl.: As above**

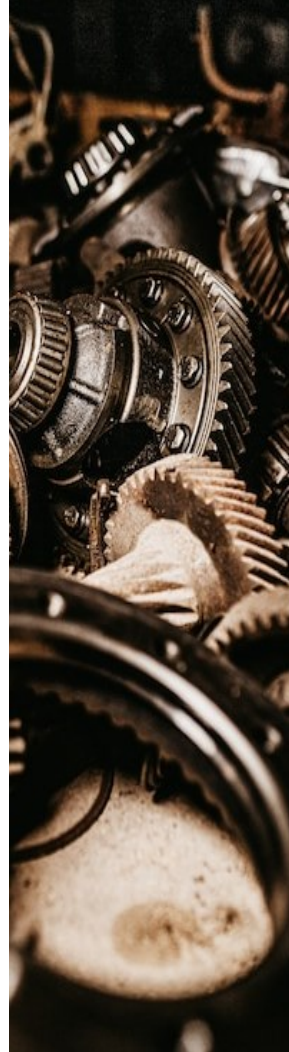
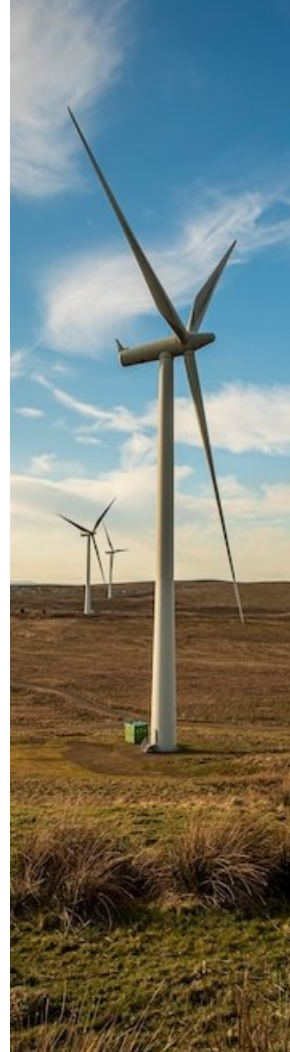
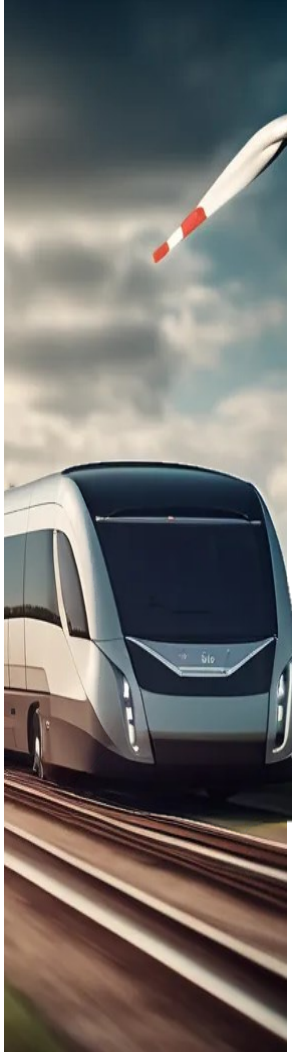

INVESTOR PRESENTATION

NOVEMBER 2024

SNAPSHOT



30+

Years of Operations



175+

Customers



750+

SKUs



Exporting to

25+

Countries



Domestic Renewal DSS
Market Share

70%



Certified by
**ISO 9001:2015/
IATF16949**

Quality standards



Revenue

24%

CAGR 2021-24



EBITDA

48%

CAGR 2021-24



PAT

110%

CAGR 2021-24



COMPANY OVERVIEW



COMPANY OVERVIEW



- Gala Precision Engineering is a renowned and preferred manufacturer of precision components in India.
- The company is supported by an experienced management team and a diverse, skilled workforce, driving consistent financial growth, operational efficiency, and high levels of repeat business.
- Leading manufacturer of Special Fastening Solutions (SFS) like High Tensile Fasteners such as Studs, Anchor Bolts, Cross Bolts, Hex Bolts, Nuts, Gallock Wedge Lock and Grip Lock Washers, as well as Disc & Strip Springs (DSS) and Coil & Spiral Springs (CSS), comprising of an extensive portfolio of 750+ SKUs.
- A diversified customer profile with more than 175 customers, with key clientele including major OEM's, Tier-1 & Channel Partners across various industries like Renewable Energy, Industrials and Mobility.
- Exporting to more than 25 countries with an office in Frankfurt, Germany and export revenues contributing to 37% in FY24.
- State-of-the-art manufacturing facilities, complemented by in-house tool design and development capacities, offer both scalability and flexibility, providing comprehensive solutions to its clients.

Operational Revenue & EBITDA Margins (%)

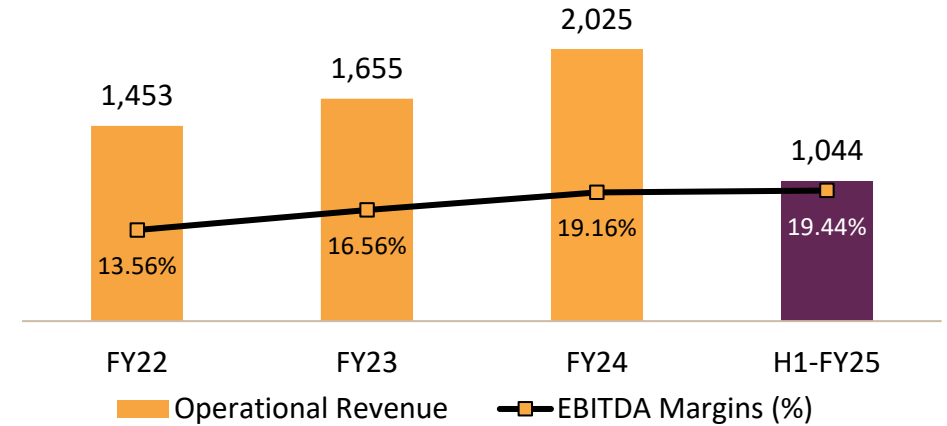

Product Break Up (H1-FY25)

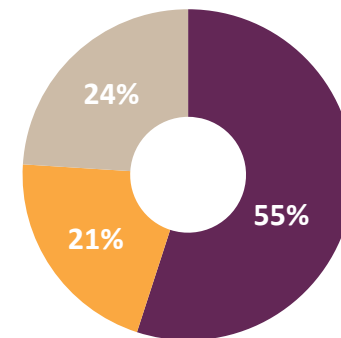

■ DSS ■ CSS ■ SFS

End User Industry Revenue Break Up (H1-FY25)

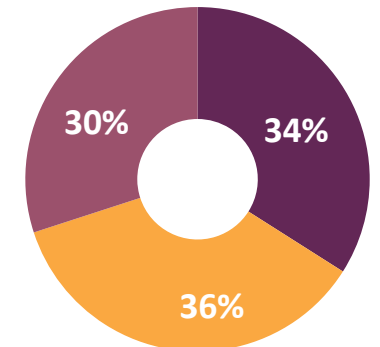

■ Industrial ■ Renewable Energy ■ Mobility

JOURNEY SO FAR

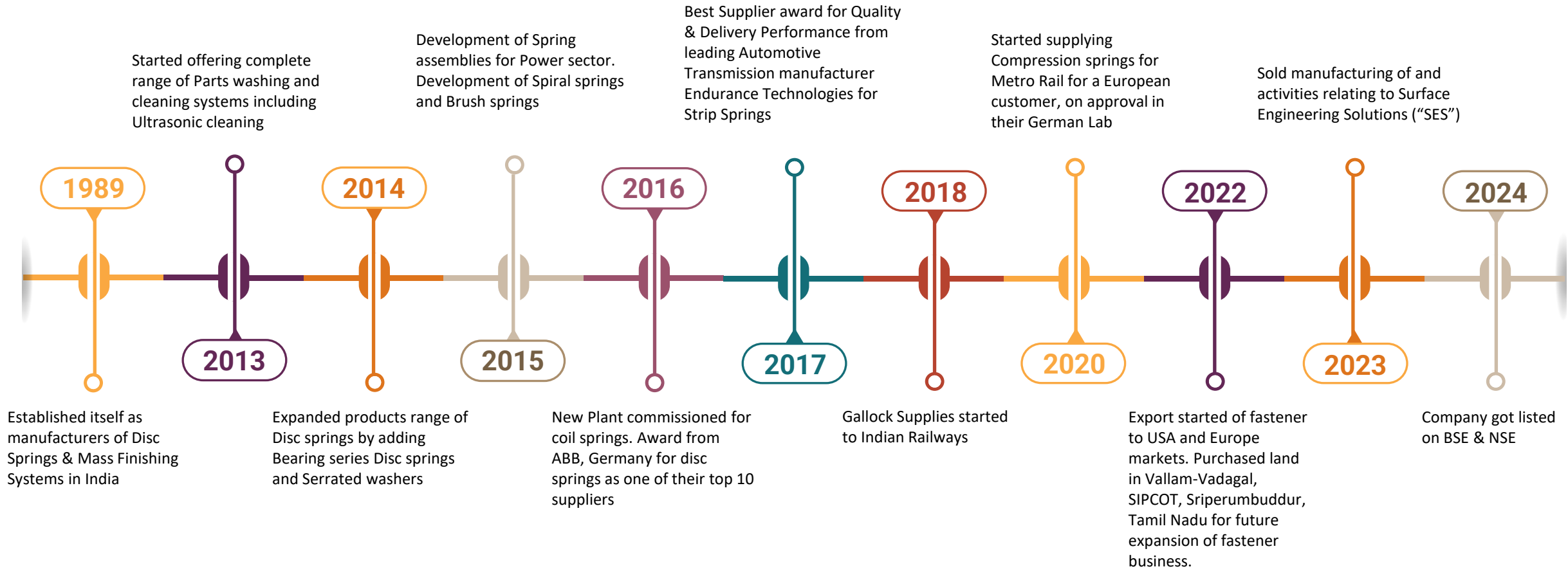

BOARD OF DIRECTORS



KIRIT GALA
CHAIRMAN & MD

- ❖ BE (Mech), MMS (Marketing) (Mumbai University)
- ❖ Speaks on topics : next generation of professional entrepreneurs, change management in VUCA world and strategy shastra



BALKISHAN JALAN
WHOLE TIME DIRECTOR (EXECUTIVE)

- ❖ Chartered Accountant-ICAI, B.com (Mumbai University)
- ❖ More than 25 years of industry experience
- ❖ Awarded as SAP ACE Excellence Awards (2010)



SATISH KOTWANI
WHOLE TIME DIRECTOR (MARKETING)

- ❖ Diploma in mechanical engineering from Board of Technical Examinations, Maharashtra (1991).
- ❖ Diploma in marketing management from the Bombay Institute of Management Studies (1996)



RAJENDRA GOGRI
NON-EXECUTIVE DIRECTOR

- ❖ Chairman & MD of listed company Aarti Industries Limited
- ❖ B Tech (Chemical)- Institute of Chemical Technology
- ❖ Recipients of UDCT Alumnus Award (1995)



SNEHAL SHAH
INDEPENDENT DIRECTOR

- ❖ PGDM (IIM-Bangalore), BE (Electrical)
- ❖ Associated with Fairwinds Asset Managers Limited as a Consultant



NEHA GADA
INDEPENDENT DIRECTOR

- ❖ Chartered Accountant- ICAI, B.com (Mumbai University), Limited Insolvency Examination from IBBI
- ❖ Awarded 1st place as a CA Woman Independent Director by ICAI (2023)
- ❖ In 4 Listed Companies, serve as an Independent Director



VARSHA GALVANKAR
INDEPENDENT DIRECTOR

- ❖ B.com (Mumbai University)
- ❖ Director at Ghalla Bhansali Consultancy Private Limited
- ❖ More than 31 years of professional experience



SUDHIR GOSAR
INDEPENDENT DIRECTOR

- ❖ B.tech (IIT-Bombay)
- ❖ More than 33 years of professional experience

GEOGRAPHICAL PRESENCE

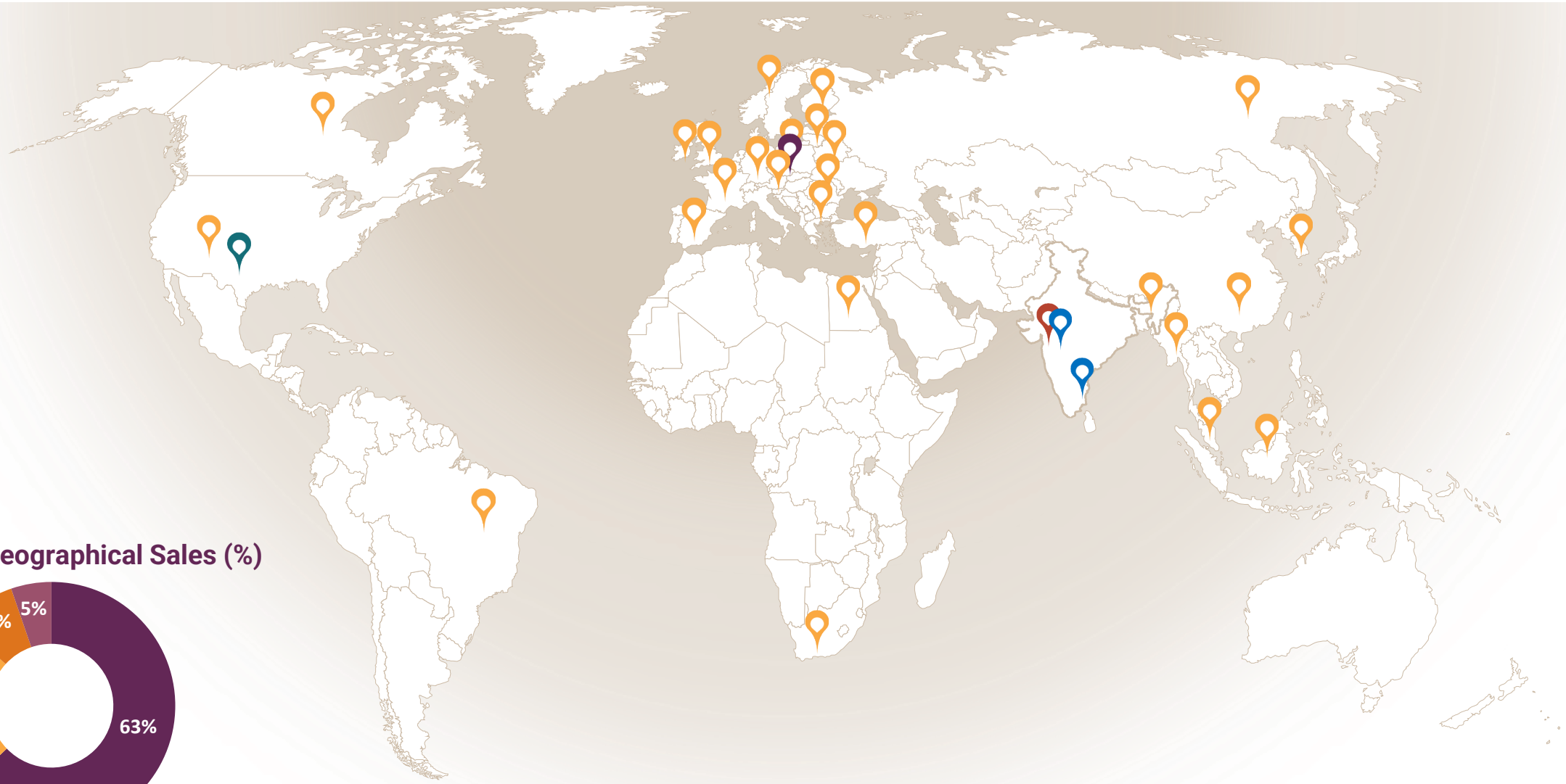

FY24 Geographical Sales (%)

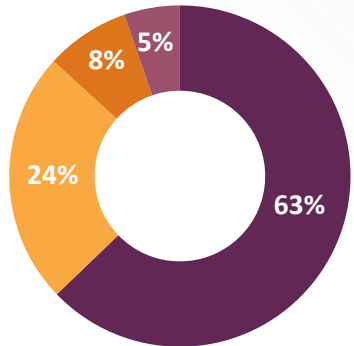

■ India ■ Europe ■ America ■ ROW



CORPORATE OFFICE



OFFICES



EXPORT COUNTRIES



FACTORY



REPRESENTATIVE

AWARDS / CERTIFICATIONS & ACCREDITATIONS

Year

Customer

Recognition

2015



Supplier of the year(DSS)

2018



Gold Category Award

2018



Appreciation certificate for positive Accomplishments

2023



High Quality & reliability supplier



Year

Institute

Recognition

2017



Star performer

2019



Certificate of Merit

2020



Silver Award, CCQC-20, Mumbai

2021



Par Excellence

2022



Best Energy Efficient Case Study

2023



Category-Mid Size Organizations

2024



India's Best Workplace in Manufacturing (Top 26-50)

MARQUEE CLIENTS



RENEWABLE ENERGY

Vestas

GE VERNOVA

ENERCON
ENERGIE FÜR DIE WELT

SENVION
wind energy solutions

Regal Rexnord



INDUSTRIAL

Schneider
Electric

LARSEN & TOUBRO

John Deere India Pvt Ltd

WÜRTH

legrand

LPS BOSSARD
Proven Productivity

BUEAB



MOBILITY

SCHAEFFLER

Wabtec
CORPORATION

HITACHI
Astemo

ENDURANCE
Complete Solutions

EXEDY
RACING CLUTCH

MSL

MANUFACTURING FACILITIES

FEW OF THE IN-HOUSE MANUFACTURING CAPABILITIES

 **Tool Design & Development**

 **Blanking & Forming**

 **Coiling**

 **Heat Treatment**

 **Shot Peening**

 **Grinding**

 **Thread Rolling**

 **CNC Machining**

**Manufacturing Plant at Wada, Near
Mumbai, Maharashtra**

Spread Across
(Land Area)

28,800 Sq Mtrs

EXISTING WADA PLANT, NEAR MUMBAI, MAHARASHTRA



UPCOMING PLANT AT VALLAM, NEAR CHENNAI, TAMIL NADU

**Upcoming Manufacturing Plant
at SIPCOT, Near Chennai, Tamil Nadu**

Spread Across
(Land Area)

6718 Sq Mtrs



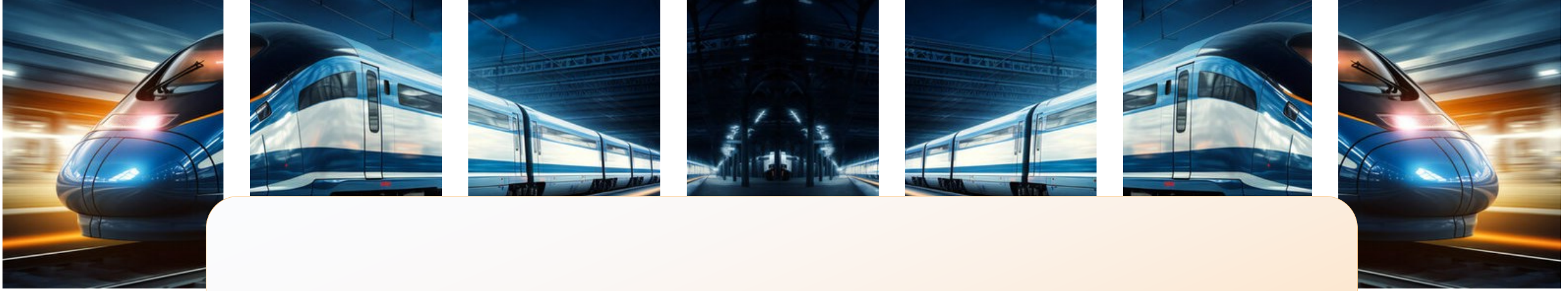







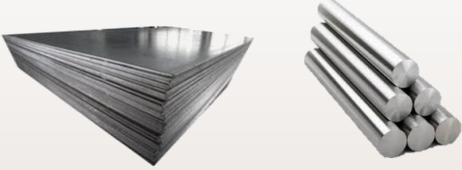







BUSINESS OVERVIEW



VALUE CHAIN

RAW MATERIAL	COMPONENTS	APPLICATIONS	END-USER INDUSTRIES
 <p>Steel Sheets Steel rods</p>	 <p>DSS & WLW</p>	<p>Renewables: Yaw brakes, thrust bearing mechanism Industrial: Transmission lines, dampening spring, elevator safety brakes Mobility: Couplers and brakes</p>	<p>Renewables: Wind turbines & hydroelectric power plants Industrial: Electricals, heavy machinery, & off-highway vehicles Mobility: Automobiles & Railways</p>
 <p>Steel wires</p>	 <p>CSS</p>	<p>Industrial: Actuators Mobility: Transmission, brakes, seating</p>	<p>Industrial: Control valves, off-highway vehicles Mobility: Automobiles, commercial vehicles & railways</p>
 <p>Steel rods</p>	 <p>SFS</p>	<p>Renewables: Foundation, tower, hydroelectric plants Industrial: Bridges Mobility: Railway tracks and bridges</p>	<p>Renewables: Wind turbines, hydroelectric power plants & solar panels Industrial: Off-highway vehicles, heavy machinery & electricals Mobility: Railways</p>

TOTAL ADDRESSABLE MARKET (TAM)

	RENEWABLE ENERGY		INDUSTRIAL				MOBILITY	
PRODUCTS	 Wind Energy	 Hydroelectric	 Off-highway	 Heavy Machinery	 Infrastructure	 Electrical	 Automotive	 Railways
DSS & WLW	●	●	●	●		●	●	●
CSS			●		●		●	●
SFS	●	●	●	●	●	●	●	●

DISC SPRING & WEDGE LOCK WASHERS

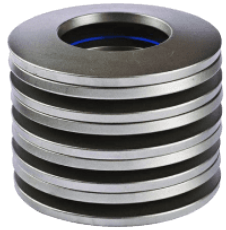

Disc Springs



Wedge Lock Washers

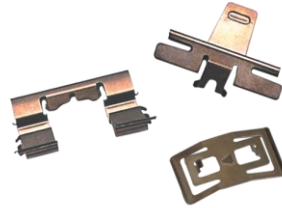

Strip Springs

- Disc spring, Strip Springs and fastening solutions used in industrial applications requiring force exertion. They offer significant spring forces in a compact design.
- These solutions are specifically designed for industrial applications, ensuring secure, vibration-resistant joints with exceptional longevity and reliability.
- Strip springs are precision-stamped components made from spring or stainless steel, designed to store and release energy under load.
- Disc springs developed through collaboration with German universities, focusing on high performance and excellent fatigue life under stress.
- Providing over 100 standard sizes (ex-stock) and online selection software, allowing for reduced spring sizes while meeting load and deflection requirements.
- **The installed capacity for DSS is 225,517,000 units, with an 85% utilization rate, contributing to 59.5% of the company's total revenue in FY2024.**

RENEWABLE ENERGY

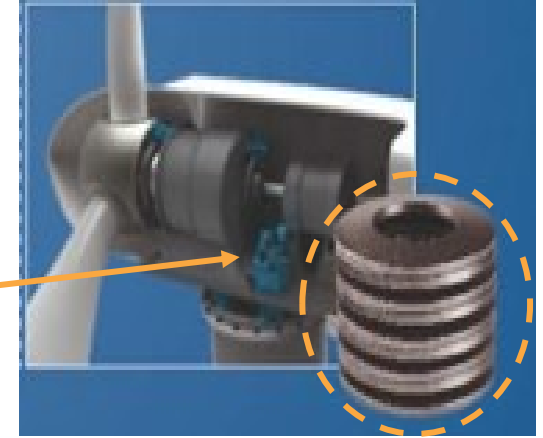

INDUSTRIAL



MOBILITY



COIL AND SPIRAL SPRINGS (CSS)



Coil Springs



Spiral Springs

- Coil Mechanical devices that store potential energy are made from wire twisted into a spiral shape, with various steel types to meet specific requirements.
- Began manufacturing CSS in 2015, utilizing expertise to produce springs for critical applications.
- CSS solutions are used in automotive, off-highway vehicles, commercial vehicles, and industrial infrastructure.
- Spiral Springs are made from rectangular metal strips wound into a flat spiral, designed to store and release rotational energy as torque.
- Spiral springs offer high durability, optimal space efficiency, various surface treatments, and cost options while meeting strict tolerances.
- **The installed capacity for CSS is 20,941,200 units, with a 78% utilization rate, contributing to 20% of the company's total revenue in FY2024.**

MOBILITY

Automotive

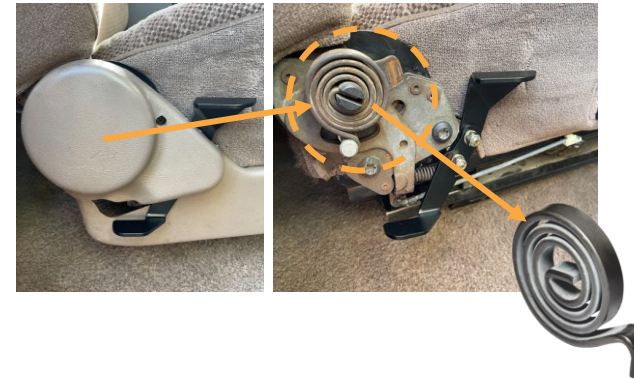

Railways



INDUSTRIAL



SPECIAL FASTENING SOLUTIONS (SFS)



Anchor bolts



Studs



Nuts

- Fasteners are hardware devices used to join or affix objects together, generally creating non-permanent joints.
- The company manufactures custom-made fasteners like studs, anchor bolts, and nuts, used in industries such as renewable energy, railways, off-highway vehicles, electrical, and heavy machinery.
- The company holds a 15% market share in the domestic specialized fastener solutions (SFS) market for wind turbines.
- **Specialty Fasteners and Systems has an installed capacity of 420,000 units with a capacity utilization of 69.94% in FY2024.**

RENEWABLE

Wind Turbine

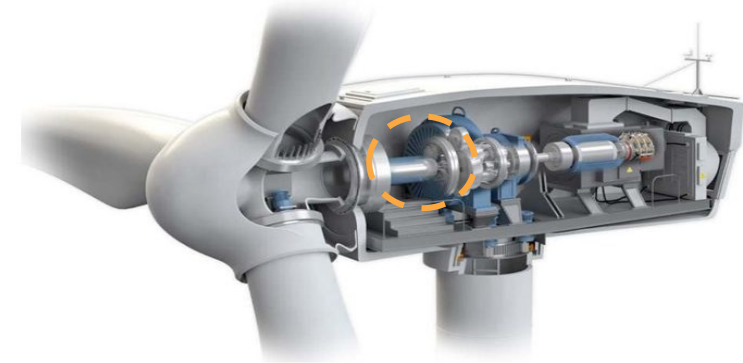

Hydro Electric Power Plant

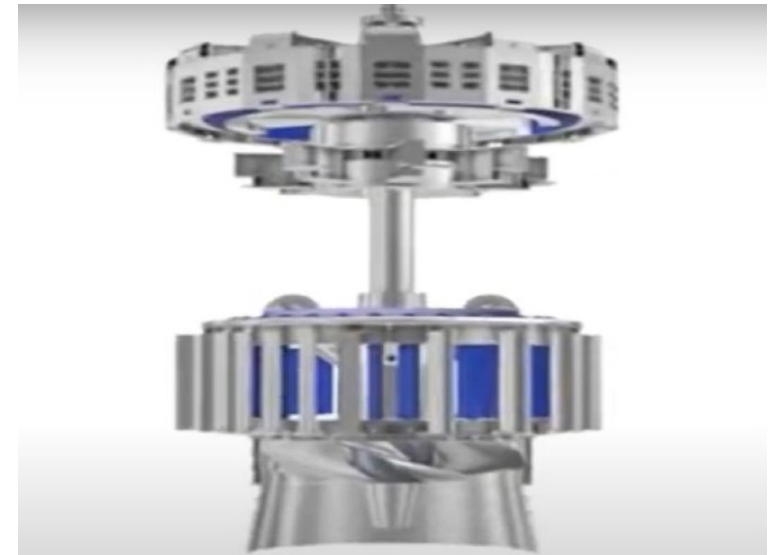

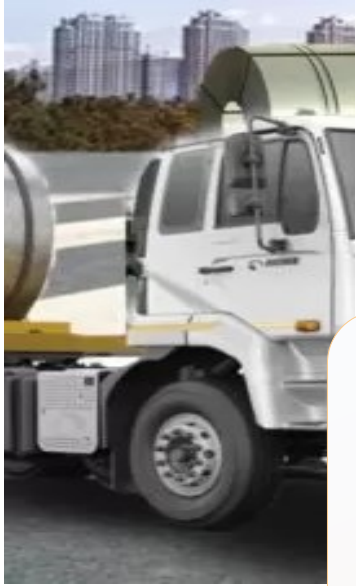

STRATEGIC OVERVIEW



KEY COMPETITIVE STRENGTHS



Well established manufacturer of precision engineering components with diversified product portfolio and diverse market

01



Long-standing customer relationships with both Indian and global OEM and Tier 1 players

02



Well-equipped manufacturing facilities along with in-house design and other capabilities which offer scale, flexibility and comprehensive solutions

03



Experienced management team supported by large, diverse and skilled work force

04



Track record of consistent financial growth and performance characterized by operational efficiency and high repeat business

05

STRATEGIC EXPANSION

RAMPING UP EXISTING CAPACITY AT WADA, NEAR MUMBAI, MAHARASHTRA



DSS facility

Current Installed Capacity (no's)

225,517,000

Capacity Utilization

85%



CSS facility

Current Installed Capacity (no's)

20,941,200

Capacity Utilization

78%



SFS Facility

Current Installed Capacity (no's)

420,000

Capacity Utilization

70%

CAPEX FROM IPO PROCEEDS

WADA PLANT, NEAR MUMBAI, MAHARASHTRA :

₹ 111 Mn

VALLAM PLANT, NEAR CHENNAI, TAMIL NADU :

₹ 370 Mn

SETTING UP NEW CAPACITY AT VALLAM, NEAR CHENNAI, TAMIL NADU

Proposed Capacity

4,600 MT

Area Sq Mtrs

4,000

Vallam – Vadagal

SIPCOT



STRATEGIC LOCATION ADVANTAGE

- Customers in close proximity
- Local job work vendors
- Nearby suppliers for raw material procurement

FUTURE GROWTH STRATEGIES

01



Strengthening our core capabilities in precision engineering for sustainability

02



Moving up the value chain from niche markets to large addressable markets

03



Leverage in-house design and development capabilities to grow our product offerings and capitalize on future trends

04



Strengthen relationships with our existing customers and expand customer base

05



Expand manufacturing capacity at our existing facilities and set-up additional strategically located facility



INDUSTRY OVERVIEW



DOMESTIC AND GLOBAL MARKET SIZE

DSS

CSS

SFS

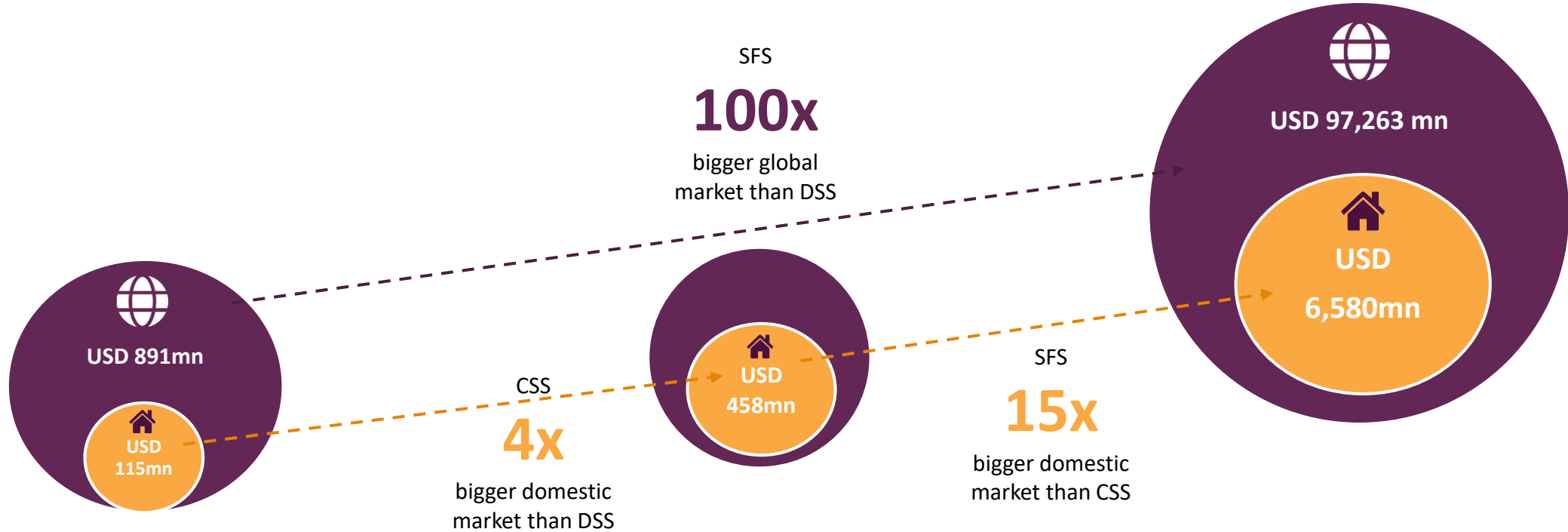

Started manufacturing of DSS products

1989



Global Market
CAGR CY24-CY26E

6.0%



Domestic Market
CAGR FY24-FY27E

6.6%

Started manufacturing of CSS products

2015



Domestic Market
CAGR FY24-FY27E

9.8%

Started manufacturing of SFS products

2018



Global Market
CAGR CY24-CY26E

6.7%



Domestic Market
CAGR FY24-FY27E

18.0%

DISC & STRIP SPRINGS AND WEDGE LOCK WASHERS

DISC & STRIP SPRINGS (DSS) INCLUDING WEDGE LOCK WASHERS (WLW)

End Industry Application (USD Mn)

CAGR FY23-26E

Global (%) **6.2%**

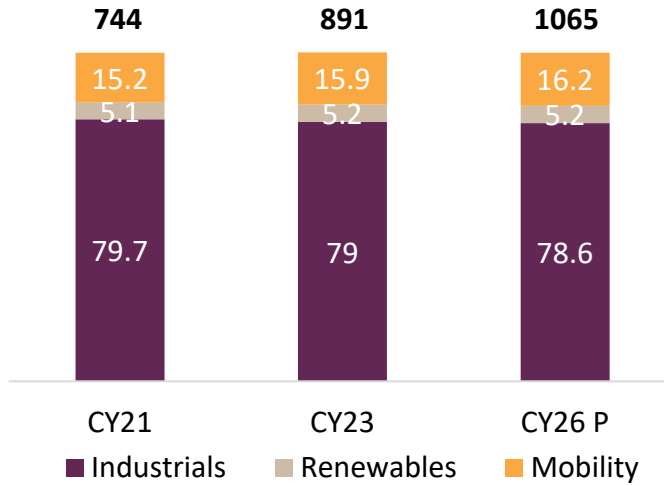

CAGR FY23-27E

Indian (%) **6.1%**

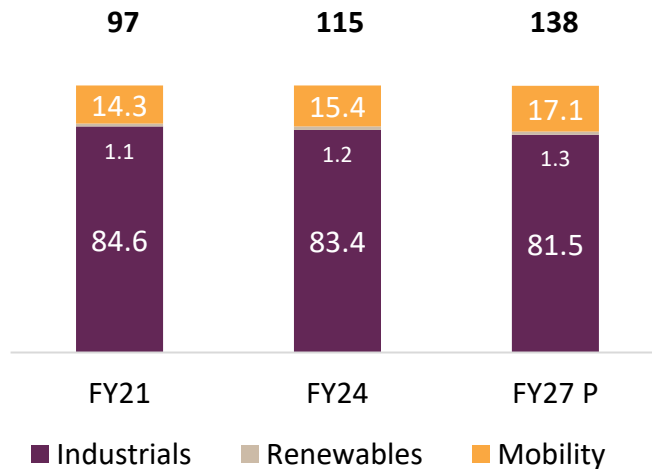

GROWTH DRIVERS



Equipment used in manufacturing and infrastructure contribute maximum revenue share



Increase in steel demand on account of rapid urbanization & construction needs



Increase consumption of passenger vehicle and increase capex toward Railway industry to fuel demand for precision products



Government favorable policies in conjunction with private capex in renewable sector such as wind and hydro has provided impetus precision products.

COIL SPRINGS & SPIRAL SPRINGS

COIL SPRINGS & SPIRAL SPRINGS

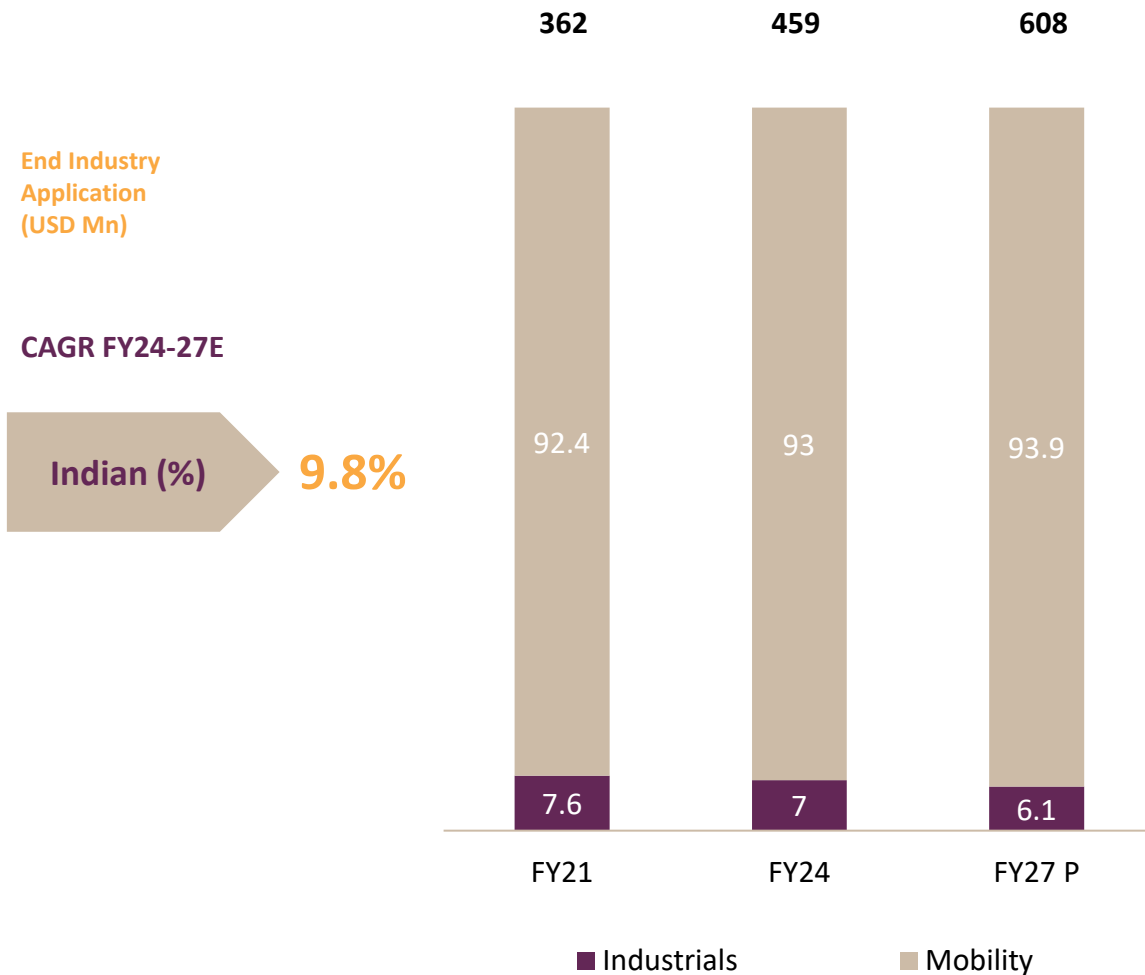

GROWTH DRIVERS



Coil spring assistance is essential for suspensions, engines, clutch, seat recliners and in-cabin shock absorbers in vehicles resulted in significant growth of the coil spring market



Upgradation of Indian railway system to high-speed rail and increased investment in metro rail has been instrumental in fueling demand for railway infrastructure



Rapid Urbanization will one of the determinant for demand of CSS products



PLI Scheme, import substitute, Urban Infrastructure will be key driver of CSS products in Industrial segment



Increase demand such as tractors, mowers, deep tillage equipment and spraying equipment has fuel demand for coil spring in advance mechanization of agriculture

SPECIAL FASTENING SOLUTIONS (SFS)

END INDUSTRY APPLICATION (USD Mn)

End Industry Application (USD Mn)

CAGR FY23-26E

GLOBAL (%)

6.7%

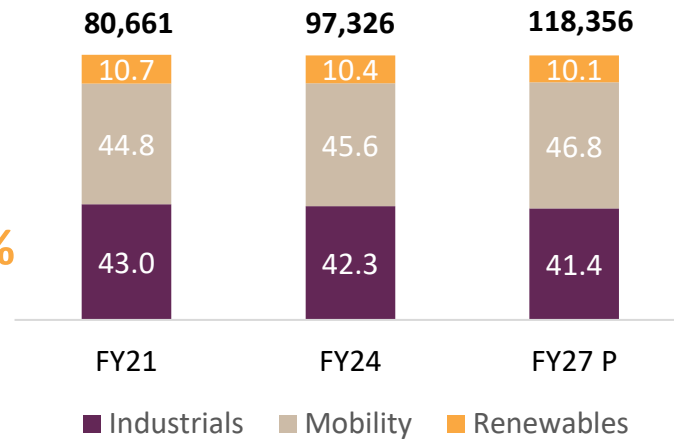

CAGR FY23-27E

INDIAN (%)

18.0%

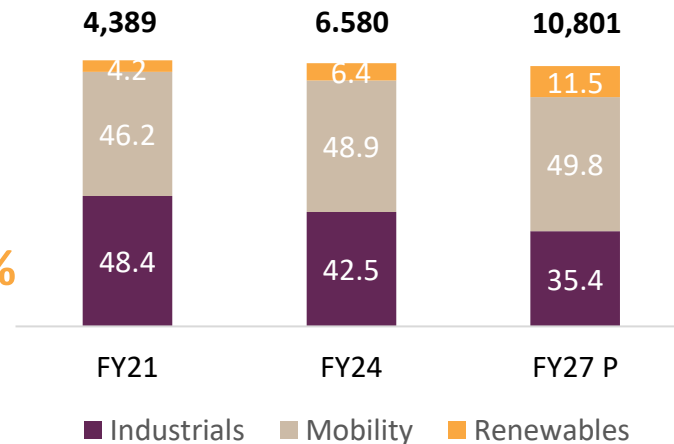

GROWTH DRIVERS



Renewable sources are projected to contribute 95% to the increased global power capacity from CY21-26. Rising demand for renewable energy will also lead to an increased need for fasteners used in constructing wind turbines, hydroelectric plants, and solar farms



Various government are focusing on replacing old age infrastructure with modern infrastructure thus fueling demand for fastening solutions



Government focus on infrastructure has led to increase in mining activity and construction has aided demand for fasteners

FURTHER OPPORTUNITIES IN DIFFERENT INDUSTRY



Note(s): CSS segment is not a focus area for us globally.

Product Category	Global Market Size (CY23 in US\$M)	Domestic Market Size (FY23 in US\$M)	Segment	Global Market Size (CY23 in US\$M)	Domestic Market Size (FY23 in US\$M)	Sub-segment	Global Market Size (CY23 in US\$M)	Domestic Market Size (FY23 in US\$M)
DSS + Wedge Lock Washers	891.2	114.8	Renewable energy	45.9	1.4	Renewable energy	45.9	1.4
			Industrial	703.9	95.8	Off-highway	397.5	77.4
						Electrical Equipment	281.5	17.5
						Heavy machinery	24.8	0.9
Mobility	141.4	17.7	Mobility	141.4	17.7			
CSS	NA	458.5	Industrial	NA	31.9	Off-Highway	NA	21.2
						Infrastructure	NA	10.8
			Mobility	NA	426.6	Commercial Vehicles	NA	22.6
						Automotive	NA	404.1
SFS	97325.5	6580	Renewable energy	10154.6	424.4	Renewable energy	10154.6	424.4
			Industrial	41184.3	2799.1	Off-highway	3953.8	539.5
						Electrical Equipment	1226.1	61.7
						Heavy machinery	36004.4	2197.8
			Mobility	44427.9	3217.3	Railway	5561.1	1236.1
						Automotive	38866.8	1981.2
Others	1558.8	139.3	Others	1558.8	139.3			
Total	98217	7153		98217	7153		98217	7153

A background image showing a business meeting with several people in suits. Overlaid on this are various financial and business icons: a large dollar sign, a circular refresh icon, a document with a dollar sign, and several line graphs and bar charts. The central text is contained within a light orange rounded rectangle.

FINANCIAL OVERVIEW



HALF YEARLY CONSOLIDATED STATEMENT OF PROFIT & LOSS



Particulars (INR Mn)	H1-FY24	H1-FY25	Y-o-Y
Revenue from Operations	957	1,044	9.1%
Total Expenses	779	841	8.0%
EBITDA	178	203	14.0%
EBITDA Margin (%)	18.60%	19.44%	84 Bps
Other Income	10	7	(30.0)%
Depreciation	34	39	14.7%
Finance Cost	30	23	(23.3)%
Profit before Exceptional Items and Tax	124	148	19.4%
Exceptional Items (Net)	(4)	(2)	(50.0)%
PBT	120	146	21.7%
Tax	24	31	29.2%
Non – Controlling Interest	-	-	-
PAT before Exceptional Item	100	117	17.0%
PAT Margin before Exceptional Item (%)	10.45%	11.21%	76 Bps
PAT after Exceptional Item	96	115	19.8%
PAT Margin after Exceptional Item (%)	10.03%	11.02%	99 Bps
Other Comprehensive Income	(1)	1	NA
Total Comprehensive Income	95	116	22.1%
EPS (INR)(not annualised)	9.37	10.81	15.4%

HISTORICAL CONSOLIDATED STATEMENT OF PROFIT & LOSS



Particulars (INR Mn)	FY22	FY23	FY24	H1-FY25
Revenue from Operations	1,453	1,655	2,025	1,044
Total Expenses	1,256	1,381	1,637	841
EBITDA	197	274	388	203
EBITDA Margin (%)	13.56%	16.56%	19.16%	19.44%
Other Income	27	16	18	7
Depreciation	63	61	69	39
Finance Cost	49	52	61	23
Profit before Exceptional Items and Tax	112	177	276	148
Exceptional Items (Net)	-	98	(23)	(2)
PBT	112	275	253	146
Tax	46	33	33	31
Non – Controlling Interest	-	-	(3)	-
PAT before Exceptional Item	66	144	246	117
PAT Margin before Exceptional Item (%)	4.54%	8.70%	12.15%	11.21%
PAT after Exceptional Item	66	242	223	115
PAT Margin after Exceptional Item (%)	4.54%	14.62%	11.01%	11.02%
Other Comprehensive Income	(3)	2	5	1
Total Comprehensive Income	63	244	228	116
EPS (INR)(not annualised)	6.44	23.56	21.77	10.81

HISTORICAL CONSOLIDATED BALANCE SHEET

Particulars (INR Mn)	FY22	FY23	FY24	H1-FY25
EQUITY AND LIABILITIES				
Equity				
Equity Share Capital	25	25	101	127
Other Equity	568	811	947	2,313
Non Controlling Interest	-	-	(3)	(4)
Total Equity	593	837	1,045	2,436
LIABILITIES				
Non-Current Liabilities				
Financial Liabilities				
-Borrowings	238	205	92	77
- Lease liabilities	-	15	11	10
- Other Financial Liabilities				
Provisions	40	46	53	60
Deferred Tax Liabilities (Net)	21	37	9	3
Current Liabilities				
Financial Liabilities				
- Borrowings	331	381	458	41
- Lease liabilities	-	3	3	4
- Trade Payables				
(A) total outstanding dues of micro & small enterprises	3	7	3	2
(B) total outstanding dues other than micro & small enterprises	135	74	133	187
- Other Financial Liabilities	57	84	64	108
Other Current Liabilities	12	9	11	13
Provisions	10	6	5	5
Current Tax Liabilities (Net)	17	-	-	-
Total Liabilities	863	867	842	510
Total Equity And Liabilities	1,456	1,704	1,887	2,946

Particulars (INR Mn)	FY22	FY23	FY24	H1-FY25
ASSETS				
Non-Current Assets				
Property, Plant and Equipment	384	382	413	415
Right of use assets	11	50	45	43
Capital Work-in-Progress	1	13	32	95
Investment Property	-	-	-	-
Goodwill	-	-	-	-
Other Intangible Assets	168	177	186	171
Intangible assets under development	29	35	33	53
Other Financial Assets	6	9	11	40
Non-Current Tax assets (net)	1	11	7	4
Other non-current assets	4	7	16	77
Current Assets;				
Inventories	497	558	577	698
Financial Assets				
- Trade Receivables	255	300	470	447
- Cash and cash Equivalents	5	5	14	2
- Bank balances other than cash and cash equivalents	21	115	27	778
- Loans	3	6	1	3
- Others financial assets	21	4	17	19
Other current assets	48	34	38	101
TOTAL ASSETS	1,456	1,704	1,887	2,946

FINANCIAL PERFORMANCE

Revenue from Operations (INR Mn)

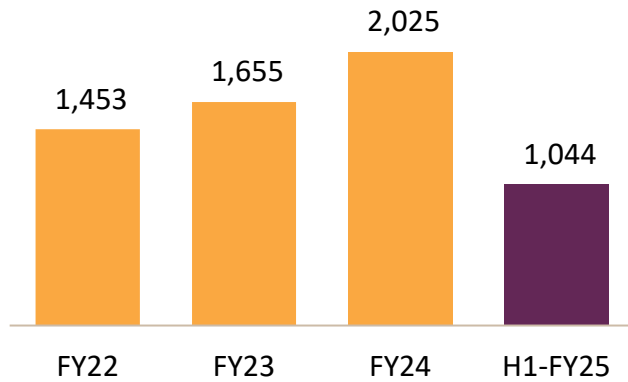

EBITDA (INR Mn) & EBITDA Margins %

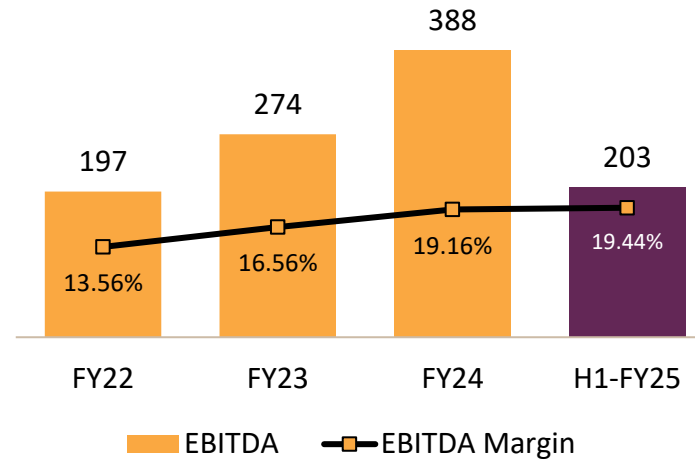

PAT (INR Mn) & PAT Margins % *

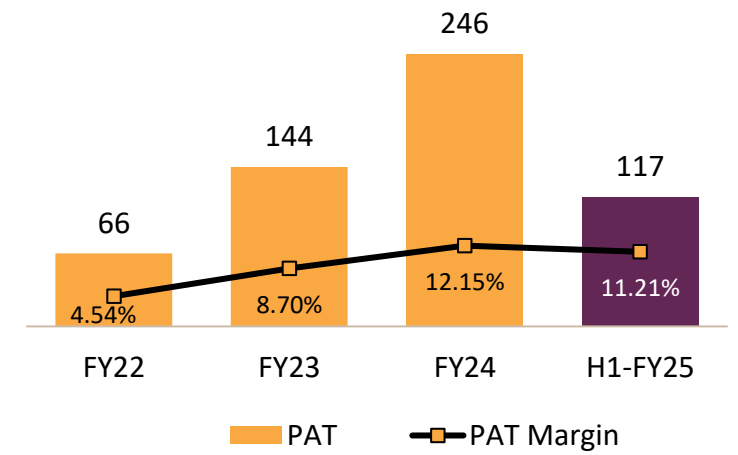

Net Worth (INR Mn)

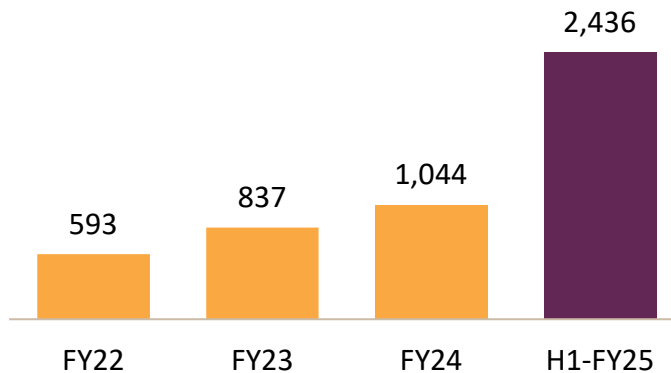

Working Capital Days

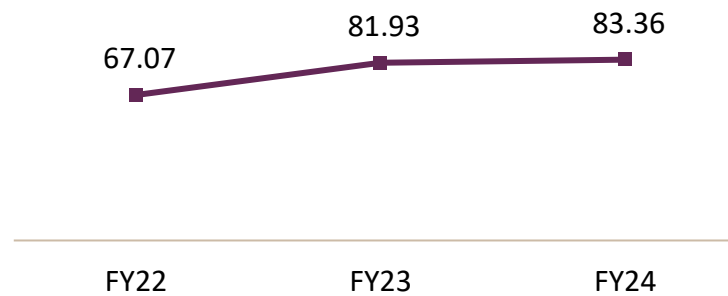

ROE* & ROCE %

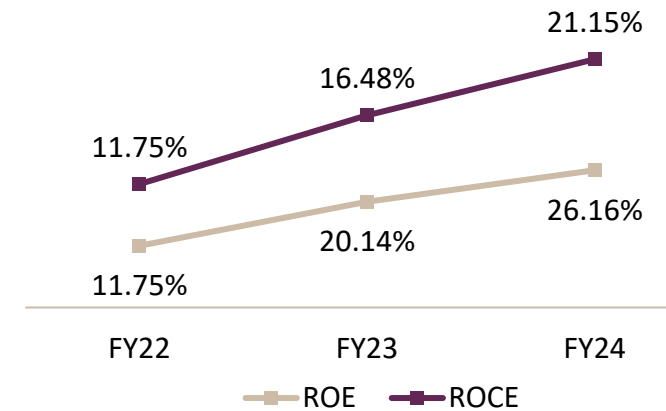

* - PAT, PAT margins & ROE calculations excludes exceptional items

CAPITAL MARKET SLIDE

9 Week Stock Performance (up to 13th November, 2024)

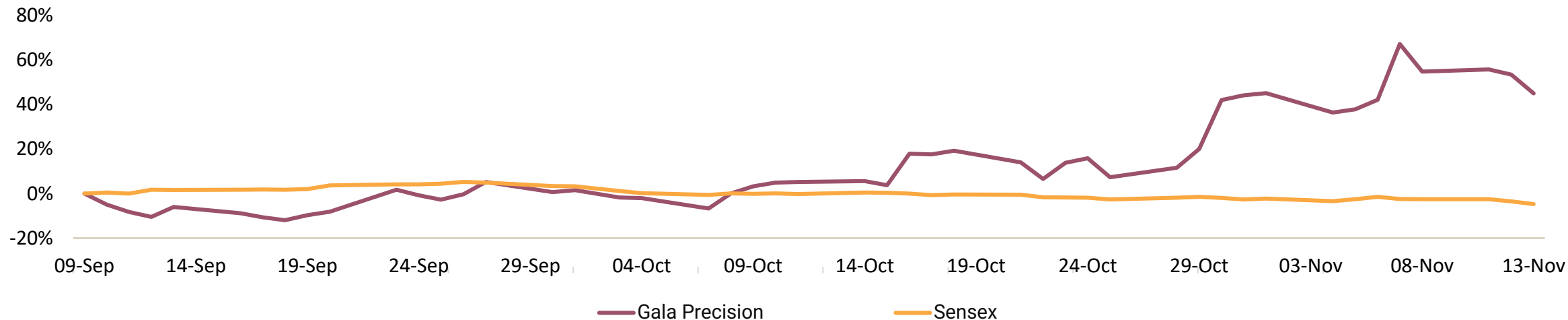

Market Data (As on 13th November, 2024)

Particulars	INR
Face Value	10.00
CMP	1,141.20
52 Week H/L	1,342.55 / 685.60
Market Capitalization (Mn)	14,459.00
Shares O/S (Mn)	12.67

Shareholding Pattern (As on 30th September, 2024)

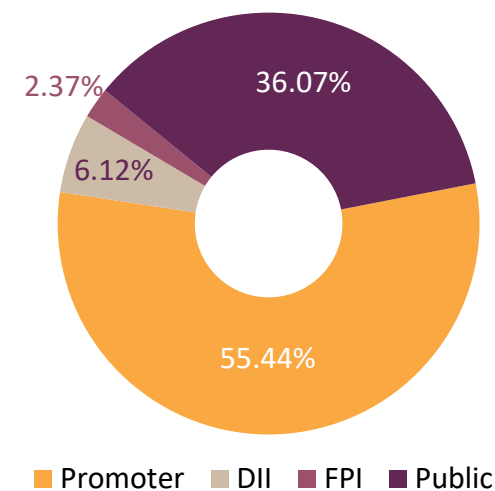

DISCLAIMER

Gala Precision Engineering Limited:

This presentation and the accompanying slides (the “Presentation”), which have been prepared by Gala Precision Engineering Limited (the “Company”), have been prepared solely for information purposes and do not constitute any offer, recommendation or invitation to purchase or subscribe for any securities, and shall not form the basis or be relied on in connection with any contract or binding commitment whatsoever. No offering of securities of the Company will be made except by means of a statutory offering document containing detailed information about the Company.

This Presentation has been prepared by the Company based on information and data which the Company considers reliable, but the Company makes no representation or warranty, express or implied, whatsoever, and no reliance shall be placed on, the truth, accuracy, completeness, fairness and reasonableness of the contents of this Presentation. This Presentation may not be all inclusive and may not contain all of the information that you may consider material. Any liability in respect of the contents of, or any omission from, this Presentation is expressly excluded.

This presentation contains certain forward looking statements concerning the Company’s future business prospects and business profitability, which are subject to a number of risks and uncertainties and the actual results could materially differ from those in such forward looking statements. The risks and uncertainties relating to these statements include, but are not limited to, risks and uncertainties regarding fluctuations in earnings, our ability to manage growth, competition (both domestic and international), economic growth in India and abroad, ability to attract and retain highly skilled professionals, time and cost over runs on contracts, our ability to manage our international operations, government policies and actions regulations, interest and other fiscal costs generally prevailing in the economy. The Company does not undertake to make any announcement in case any of these forward looking statements become materially incorrect in future or update any forward looking statements made from time to time by or on behalf of the Company.

Valorem Advisors Disclaimer:

Valorem Advisors is an Independent Investor Relations Management Service company. This Presentation has been prepared by Valorem Advisors based on information and data which the Company considers reliable, but Valorem Advisors and the Company makes no representation or warranty, express or implied, whatsoever, and no reliance shall be placed on, the truth, accuracy, completeness, fairness and reasonableness of the contents of this Presentation. This Presentation may not be all inclusive and may not contain all of the information that you may consider material. Any liability in respect of the contents of, or any omission from, this Presentation is expressly excluded. Valorem Advisors also hereby certifies that the directors or employees of Valorem Advisors do not own any stock in personal or company capacity of the Company under review.

For further details, please feel free to contact our Investor Relations Representatives:



VALOREM ADVISORS

“Your Partners in Value Creation”

Mr. Anuj Sonpal

Valorem Advisors

Tel: +91-22-49039500

Email: gala@valoremadvisors.com

THANK YOU



**GALA PRECISION
ENGINEERING LIMITED**