



30<sup>th</sup> July 2022

<b>BSE Limited</b> Phiroze Jeejeebhoy Towers Dalal Street Mumbai: 400 001 <b>Scrip Code: 500440</b>	<b>National Stock Exchange of India Limited</b> Exchange Plaza, 5th Floor Plot No. C/1, G Block Bandra Kurla Complex Bandra (East) Mumbai – 400 051 <b>Scrip Code: HINDALCO</b>
<b>Mr. Daniel Schammo</b> Banque Internationale A Luxembourg Societe Anonyme 69, Route d'Esch L-2953 Luxembourg Fax No. 00 352 4590 2010 Tel. No. 00 352 4590-1	

**Dear Sirs,**

**Sub: Annual General Meeting Notice, Integrated Annual Report 2021-22**

The Sixty Third Annual General Meeting (“AGM”) of the Company will be held on Tuesday, 23<sup>rd</sup> August 2022 at 03.00 p.m. IST through Video Conferencing / Other Audio-Visual Means.

Pursuant to Regulation 34(1) of Securities and Exchange Board of India (Listing Obligations and Disclosure Requirements) Regulations, 2015, we are submitting herewith the Integrated Annual Report of the Company along with the Notice of AGM for the financial year 2021-22 which is being sent to the Members, who have registered their e-mail addresses with the Company/ Depositories, through electronic mode.

The Integrated Annual Report containing the Notice is also uploaded on the Company’s website i.e [www.hindalco.com](http://www.hindalco.com).

This is for your information and records.

Thanking You,

For **Hindalco Industries Limited**

**Anil Malik**  
**President & Company Secretary**

**Hindalco Industries Limited**

6<sup>th</sup> & 7<sup>th</sup> Floor, Birla Centurion, Pandurang Budhkar Marg, Worli, Mumbai – 400030, India  
T: +91 22 66626666/62610555 | F: +912262610400/62610500 | W: [www.hindalco.com](http://www.hindalco.com)  
Registered Office : Ahura Centre, 1<sup>st</sup> Floor, B wing, Mahakali Caves Road, Andheri (East), Mumbai – 400093, India  
Corporate ID No: L27020MH1958PLC011238



## HINDALCO INDUSTRIES LIMITED

CIN No: L27020MH1958PLC011238

**Registered Office:** Ahura Centre, 1<sup>st</sup> Floor, B Wing, Mahakali Caves Road, Andheri (East), Mumbai- 400 093.

Tel: (91-22) 6691 7000, Fax: (91-22) 6691 7001, Email: [hilinvestors@adityabirla.com](mailto:hilinvestors@adityabirla.com), website: [www.hindalco.com](http://www.hindalco.com)

**NOTICE** is hereby given that, the **Sixty-third** Annual General Meeting ('AGM') of the Shareholders of Hindalco Industries Limited ("the Company") will be held on Tuesday, 23<sup>rd</sup> August, 2022 at 03:00 p.m. (IST) through Video Conferencing (VC) or Other Audio Visual Means (OAVM), to transact the following business:

### ORDINARY BUSINESS:

1. To receive, consider and adopt the Audited Financial Statements (including Audited Consolidated Financial Statements) for the year ended 31<sup>st</sup> March, 2022 together with Report of the Directors and the Auditors thereon.
2. To declare Dividend on equity shares of the Company for the year ended 31<sup>st</sup> March, 2022.
3. **To appoint a Director in place of Mr. Kumar Mangalam Birla (DIN: 00012813) who retires by rotation and being eligible, offers himself for re-appointment.**

"**RESOLVED THAT** pursuant to the provisions of Section 152 and other applicable provisions of the Companies Act, 2013, Mr. Kumar Mangalam Birla (DIN:00012813), who retires by rotation and being eligible, offers himself for reappointment, be and is hereby appointed as a Non-Executive Director of the Company, with the consent of the members of the Company, accorded under Regulation 17(1A) of the Securities and Exchange Board of India (Listing Obligations and Disclosure Requirements) Regulations, 2015."

4. **Appointment of Statutory Auditors of the Company**  
To consider and if thought fit, to pass the following resolution as an Ordinary Resolution:

"**RESOLVED THAT** pursuant to the provisions of Sections 139, 142 and other applicable provisions, if any, of the Companies Act, 2013 and the Companies (Audit and Auditors) Rules, 2014 (including any statutory modification(s) or re-enactment thereof for the time

being in force), and pursuant to recommendation of Audit committee and Board of Directors, M/s. Price Waterhouse & Co. Chartered Accountants LLP (Registration No. 304026E/E-300009) be and is hereby re-appointed as Statutory Auditors of the Company to hold office from the conclusion of this Annual General Meeting ("AGM") till the conclusion of the Sixty Eighth AGM to be held in the year 2027, at such remuneration, as may be mutually agreed between the Company and the Statutory Auditors from time to time.

**RESOLVED FURTHER THAT** the Board of Directors be and is hereby authorised to do all such acts, deeds, matters and things as may be considered necessary, desirable and expedient to give effect to this Resolution."

### SPECIAL BUSINESS:

- 5 **To ratify the remuneration of the Cost Auditors for the financial year ending 31<sup>st</sup> March, 2023 and in this regard to consider and if thought fit, to pass the following resolution, which will be proposed as an Ordinary Resolution:**

"**RESOLVED THAT** pursuant to the provisions of Section 148 and all other applicable provisions, if any, of the Companies Act, 2013 and the Companies (Audit and Auditors) Rules, 2014 (including any statutory modification(s) or re-enactment thereof, for the time being in force), the remuneration of ₹ 18,00,000/- per annum (Rupees Eighteen Lakhs only) plus taxes, as applicable and reimbursement of actual travel and out-of-pocket expenses for the financial year ending 31<sup>st</sup> March, 2023 to be paid to M/s R. Nanabhoy & Co., Cost Accountants, appointed by the Board of Directors of the Company to conduct audit of the cost records of the Company, be and is hereby ratified and confirmed.

**RESOLVED FURTHER THAT** the Board of Directors of the Company (including any Committee thereof) be and is hereby authorised to do all such acts, deeds and things and take all such steps as may be necessary, proper or expedient to give effect to this resolution."

**6 Adoption of the Hindalco Industries Limited Employee Stock Option and Performance Stock Unit Scheme 2022**

**To consider and if thought fit, to pass the following resolution as a Special Resolution:**

**"RESOLVED THAT** pursuant to applicable provisions of the Companies Act, 2013 ("Act") and Rules made thereunder; Regulation 6 and other applicable provisions, if any, of the Securities and Exchange Board of India (Share Based Employee Benefits and Sweat Equity) Regulations, 2021 ("SEBI SBEB & SE Regulations"); the Securities and Exchange Board of India (Listing Obligations and Disclosure Requirements) Regulations, 2015; any rules, guidelines and regulations issued by the Reserve Bank of India and such other laws, rules and regulations (including any statutory amendment(s) or modification(s) or re-enactment(s) thereof, for the time being in force) as may be applicable( collectively, the "Applicable Laws"), the relevant provisions of the Articles of Association of the Company and further subject to such other approvals, consent, permissions and sanctions as may be necessary from the appropriate authorities or bodies and subject to such conditions and modifications as may be prescribed or imposed by the above authorities and which may be agreed to and accepted by the Board of Directors (hereinafter referred to as the "Board" which term shall be deemed to include any duly constituted committee, including the Nomination, Remuneration and Compensation Committee to exercise its powers conferred by this Resolution), consent of the Members be and is hereby granted for adoption of the 'Hindalco Industries Limited Employee Stock Option and Performance Stock Unit Scheme 2022' ("the Scheme 2022"), the salient features of which are furnished in the explanatory statement to the Notice and the same be implemented through the Hindalco Employees Welfare Trust ("the Trust").

**RESOLVED FURTHER THAT** consent be and is hereby granted to the Board to create, grant, offer and issue in one or more tranches under the Scheme 2022, at any time to or for the benefit of the employees of the Company, whether working in India or outside India, including any

managing or whole-time directors of the Company, its Group Company(ies), as defined in the SEBI SBEB & SE Regulations, including holding / subsidiary or associate company (ies), such number of stock options (comprising of options and / or performance stock units, as the case may be) (the "Stock Options") exercisable into not more than 1,68,28,000 equity shares of ₹ 1/- each ("Equity Shares") being 0.75% of the paid-up equity share capital of the Company as on 31<sup>st</sup> March, 2022 (or such other number adjusted in terms of Scheme 2022 as per applicable law), at such price, in one or more tranches and on such terms and conditions as may be fixed or determined by the Board in accordance with the SEBI SBEB & SE Regulations or other provisions of law as may be prevailing at that time.

**RESOLVED FURTHER THAT** in case of any corporate action(s) such as rights issues, bonus issues, merger and sale of division or other reorganisation of capital structure of the Company, as applicable from time to time, the Board be and is hereby authorised to do all such acts, deeds, matters and things as it may deem fit in its absolute discretion and as permitted under applicable laws, so as to ensure a fair and reasonable adjustment to the Stock Options granted earlier. Further, the above ceiling of 0.75% i.e., 1,68,28,000 Equity Shares shall be deemed to be increased to the extent of such additional equity shares issued.

**RESOLVED FURTHER THAT** in case the equity shares are either sub-divided or consolidated, then the number of equity shares to be transferred on exercise of Stock Options and the exercise price of Stock Options shall automatically stand augmented or reduced, as the case may be, in the same proportion as the present face value of ₹ 1/- per equity share bears to the revised face value of the equity shares of the Company after such sub-division or consolidation, without affecting any other rights or obligations of the employees who have been granted Stock Options under the Scheme 2022.

**RESOLVED FURTHER THAT** the Board be and is hereby authorised to formulate, evolve, decide upon and implement the Scheme 2022 and determine the detailed terms and conditions of the aforementioned Scheme 2022 including but not limited to the quantum of the Stock Options to be granted per employee in each tranche, the exercise period, the vesting period, the vesting conditions, instances where such Stock Options shall lapse and to grant such number of Stock Options, to such employees and directors of the Company and its

group companies, including its holding / subsidiary and associate company (ies), at such time and on such terms and conditions as set out in the Scheme 2022 and as the Board may in its absolute discretion think fit, subject to applicable laws.

**RESOLVED FURTHER THAT** for the purpose of giving effect to the above resolution, the Board be and is hereby authorised to do all such acts, deeds, matters and things as it may, in its absolute discretion, deem necessary, expedient or proper and to settle all questions, difficulties or doubts that may arise in relation to formulation and implementation of the Scheme 2022 at any stage without requiring the Board to secure any further consent or approval of the Members of the Company to the end and intent that they shall be deemed to have given their approval thereto expressly by the authority of this resolution.

**RESOLVED FURTHER THAT** the Board be and is hereby authorised to make any modification(s), change(s), variation(s), alteration(s) or revision(s) in the Scheme 2022, as it may deem fit, from time to time or to suspend, withdraw or revive the Scheme 2022, from time to time in conformity with the provisions of the Act and rules made thereunder, the SEBI SBEB & SE Regulations and other applicable laws provided such variation(s), amendment(s), modification(s) or alteration(s) is not detrimental to the interest of the employees who have been granted Stock Options under the Scheme 2022.

**7 To approve extending the benefits of the Hindalco Industries Limited Employee Stock Option and Performance Stock Unit Scheme 2022 to the employees of the group companies including holding, Subsidiary and associate Companies of Company.**

To consider and if thought fit, to pass the following resolution as a Special Resolution:

**“RESOLVED THAT** pursuant to the applicable provisions of the Companies Act, 2013 (“Act”) and Rules made thereunder; Regulation 6 and other applicable provisions, of any, of the Securities and Exchange Board of India (Share Based Employee Benefits and Sweat Equity) Regulations, 2021 (“SEBI SBEB & SE Regulations”); the Securities and Exchange Board of India (Listing Obligations and Disclosure Requirements) Regulations, 2015, any rules, guidelines and regulations issued by the Reserve Bank of India and such other laws, rules and regulations (including any statutory modification(s) or amendment(s) thereto or re-enactment(s) thereof, for the

time being in force) as may be applicable (collectively, the “Applicable Law”), the relevant provisions of the and Articles of Association of the Company and further subject to such other approvals, consent, permissions and sanctions as may be necessary from the appropriate authorities or bodies and subject to such conditions and modifications as may be prescribed or imposed by the above authorities, and which may be agreed to and accepted by the Board of Directors (hereinafter referred to as the “Board” which term shall be deemed to include any duly constituted committee, including the Nomination, Remuneration and Compensation Committee to exercise its powers conferred by this Resolution) consent of the Members be and is hereby accorded to the Board to extend the benefits and coverage of the Scheme 2022 (referred to in the Resolution under Item No. 6 of this Notice) to such persons who are in employment of any present and future group company of the Company including holding, associate and subsidiary company(ies) of the Company who is working in India or outside India, including any managing or whole-time director(s) (selected on the basis of criteria decided by the Board) under the Scheme 2022 in the manner mentioned in the Resolution under Item No. 6 of this Notice on such terms and conditions as may be fixed or determined by the Board in accordance with the SEBI SBEB & SE Regulations or other provisions of law as may be prevailing at that time.

**RESOLVED FURTHER THAT** for the purpose of giving effect to the resolution, the Board be and is hereby authorised to do all such acts, deeds, matters and things as it may, in its absolute discretion, deem necessary, expedient or proper to settle any questions, difficulties or doubts that may arise in this regard.”

**8 To approve (a) the use of the trust route for the implementation of the Hindalco Industries Limited Employee Stock Option and Performance Stock Unit Scheme 2022 (“Scheme 2022”); (b) secondary acquisition of the equity shares of the Company by the trust; and (c) grant of financial assistance / provision of money by the Company to the trust to fund the acquisition of its equity shares, in terms of the Scheme 2022**

To consider and if thought fit, to pass the following resolution as a Special Resolution:

**“RESOLVED THAT** pursuant to the provisions of Section 67 and other applicable provisions, if any, of



the Companies Act, 2013 ("the Act") and Rules made thereunder; and other applicable provisions, if any, of the Securities and Exchange Board of India (Share Based Employee Benefits and Sweat Equity) Regulations, 2021 ("SEBI SBEB & SE Regulations"); the Securities and Exchange Board of India (Listing Obligations and Disclosure Requirements) Regulations, 2015, and any rules, guidelines and regulations issued by the Reserve Bank of India and such other laws, rules and regulations (including any statutory modification(s) or amendment(s) or re-enactment(s) thereof, for the time being in force) as may be applicable (collectively, the "Applicable Laws"), the relevant provisions of the Articles of Association of the Company and further subject to such other approvals, consent, permissions and sanctions as may be necessary from the appropriate authorities or bodies and subject to such conditions and modifications as may be prescribed or imposed by the above authorities and which may be agreed to and accepted by the Board of Directors (hereinafter referred to as the "Board" which term shall be deemed to include any duly constituted committee, including the Nomination, Remuneration and Compensation Committee to exercise its powers conferred by this Resolution) consent of the Members be and is hereby accorded to the Board to:

- (a) implement the Hindalco Industries Limited Employee Stock Option and Performance Stock Unit Scheme 2022 (the "Scheme 2022") through the Hindalco Employee Welfare Trust ("the Trust") in accordance with the SEBI SBEB & SE Regulations.
- (b) acquire, hold and deal in such number of equity shares of the Company, from the secondary market through the Trust, not exceeding 1,68,28,000 fully paid-up equity shares of the Company of face value of ₹1/- each (the "Equity Shares"), being below the ceiling of 5% of the paid-up equity share capital of the Company as on 31<sup>st</sup> March, 2022, as prescribed under the Applicable Laws.
- (c) extend an interest free financial assistance / provision of money to the Trust not exceeding ₹ 740 crores (rupees seven hundred and Forty crores only) in accordance with the Applicable Laws in one or more tranches, for acquisition of up to 1,68,28,000 Equity Shares of the Company from the secondary market through the stock exchanges, representing 0.75% of the paid-up equity share capital of the Company as on 31<sup>st</sup> March, 2022, for the

purpose of implementation of the Scheme 2022, in accordance with the provisions of the Act and Rules made thereunder and the SEBI SBEB & SE Regulations.

**RESOLVED FURTHER THAT** the Equity Shares that can be acquired from the secondary market in any financial year by the Trust shall not exceed 2% of the paid-up equity share capital (or such other limit as may be prescribed under the SEBI SBEB & SE Regulations from time to time) as at the end of the financial year preceding the date of the intended acquisition.

**RESOLVED FURTHER THAT** in case of any corporate action(s) such as rights issues, bonus issues, merger and sale of division or other reorganisation of capital structure of the Company, the number of Equity Shares of the Company to be acquired from the secondary market by the Trust shall be appropriately adjusted and to give effect to this resolution, the Board be and is hereby authorised to do all such acts, deeds, matters and things as it may deem fit in its absolute discretion and as permitted under applicable laws, so as to ensure a fair and reasonable adjustment to the Stock Options granted earlier. Further, the above ceiling of 0.75% equity shares shall be deemed to be increased to the extent of such additional Equity Shares issued

**RESOLVED FURTHER THAT** the financial assistance / money provided by the Company to the Trust shall be repayable to and recoverable by the Company from time to time during the term of the Scheme 2022 subject to exercise price being paid by the employees on exercise of stock options and performance stock units under the Scheme 2022.

**RESOLVED FURTHER THAT** the trustees of the Trust shall ensure compliance of the provisions of the SEBI SBEB & SE Regulations, the Act and all other applicable laws at all times in connection with dealing with the equity shares of the Company including but not limited to maintenance of proper books of account, records and documents as prescribed.

**RESOLVED FURTHER THAT** the Board be and is hereby authorised to delegate all or any powers conferred herein, to any committee of directors, with power to further delegate such powers to any executives/ officers of the Company to do all such acts, deeds, matters and things as also to execute such documents, writings, etc. as may be necessary in this regard."

**9 To re-appoint Mr. Praveen Kumar Maheshwari (DIN:00174361) as Whole-time Director.**

To consider and if thought fit, to pass the following resolution, which will be proposed as an Ordinary Resolution:

**“RESOLVED THAT** pursuant to the relevant provisions of the Articles of Association of the Company (hereinafter referred to as the “Articles”) and the Companies Act, 2013 (hereinafter referred to as the “Act”) including Section 160, Mr. Praveen Kumar Maheshwari (DIN No. 00174361) be and is hereby re-appointed as a Director of the Company, not liable to retire by rotation.

**RESOLVED FURTHER THAT** Mr. Praveen Kumar Maheshwari shall cease to be a director of the Company if he ceases to be a Whole-time Director of the Company.

**RESOLVED FURTHER THAT** pursuant to Sections 196, 197, 198 and all other applicable provisions of the Companies Act, 2013, read with Schedule V thereto and the Rules made thereunder, including the Companies (Appointment and Remuneration of Managerial Personnel) Rules, 2014 (including any statutory modification or re-enactment thereof, for the time being in force), and subject to the approval of the Central Government, if required, the re-appointment of Mr. Praveen Kumar Maheshwari as the Whole-time Director of the Company with effect from 28<sup>th</sup> May, 2022, be and is hereby approved, on the terms as to remuneration and otherwise as set out hereunder and with liberty to the Board (which term shall be deemed to include the Committee, if any, constituted by the Board from time to time) to alter the said terms and conditions in such manner as may be agreed to between the Board and Mr. Praveen Kumar Maheshwari in the best interests of the Company but subject to the restrictions, if any, contained in the said Act or otherwise as may be permissible at law

Terms and Conditions of appointment:

**A. Period:**

One Year w.e.f. 28<sup>th</sup> May, 2022 with the liberty to either party to terminate the appointment on three months’ notice in writing to the other.

**B. Remuneration:**

(a) Basic Salary ₹ 1,35,30,588/- (Rupees One Crore Thirty Five Lac Thirty Thousand and Five Hundred Eighty Eight only) per annum with such increments as the Board may decide from

time to time, subject however to a ceiling of ₹ 1,80,00,000/- (Rupees One Crore Eighty Lacs only) per annum as Basic Salary.

- (b) Special Allowance ₹ 1,49,81,016/- (Rupees One Crore Forty Nine Lac Eighty one Thousand and Sixteen only) per annum with such increments as the Board may decide from time to time, subject however to a ceiling of ₹ 2,04,00,000/- (Rupees Two Crore Four Lacs only) per annum. This allowance however, will not be taken into account for calculation of benefits such as Provident Fund, Gratuity, Superannuation and Leave encashment.
- (c) Annual Incentive Pay: Performance Bonus linked to the achievement of targets, as may be decided by the Board from time to time, subject to a maximum of ₹ 4,00,00,000/- (Rupees Four Crore only) per annum.
- (d) Long-term Incentive Compensation (LTIC) including Employee Stock Option, Restricted Stock Units, Stock Appreciation Rights, Phantom Restricted Stock Units as per the Scheme applicable to the Executive Directors and/or Senior Executives of the Company and/or its Subsidiaries and/or any other Incentives applicable to Senior Executives of the Company/Aditya Birla Group, in such manner and with such provisions as may be decided by the Board, considering the above.

**C. Perquisites:**

- (a) Housing: Company provided (furnished/unfurnished) accommodation and / or HRA in lieu of company provided accommodation as per the Company’s Policy.
- (b) House Maintenance: Reimbursement of expenses at actual pertaining to electricity, gas, water, telephone and other reasonable expenses for the upkeep and maintenance in respect of such accommodation as per the Company’s Policy
- (c) Medical Expenses Reimbursement: Reimbursement of all expenses incurred for self and family (including domiciliary and medical expenses and insurance premium for medical and hospitalization policy as applicable), as per the Company’s policy
- (d) Life Insurance: Life Insurance cover as per Company policy.
- (e) Accidental Insurance: Accidental insurance cover as per Company policy.

- (f) Leave Travel Expenses: Leave Travel Expenses for self and family in accordance with policy of the Company.
- (g) Car: Up to Two cars for use of the Company's Business, as per the Company's policy.
- (h) Other Expenses: Entertainment, travelling and all other expenses incurred for the business of the Company as per policy of the company.
- (i) Contribution towards Provident Fund and/or Superannuation Fund and/or National Pension Scheme or Annuity Fund as per the Company's Policy.
- (j) Gratuity and /or contribution to the Gratuity Fund of the Company as per the Company's Policy.
- (k) Club Membership: Fees of Two Clubs in India (including admission and annual membership fee).
- (l) Other Benefits: Leave and related benefits as per the Company's policy.
- (m) Other Allowances/benefits, perquisites: Any other allowances, benefits and perquisites as per the Rules applicable to the Senior Executives of the Company and/ or which may become applicable in the future and/ or any other allowance, perquisites as the Board from time to time decide.
- D. Subject as aforesaid, the Whole-Time Director shall be governed by such other Rules as are applicable to the Senior Executives of the Company from time to time.
- E. For the purposes of Gratuity, Provident Fund, Superannuation and other like benefits, if any, the service of Mr. Praveen Kumar Maheshwari, will be considered as continuous service with the Company from the date of his joining the Aditya Birla Group.
- F. The aggregate of the remuneration and perquisites as aforesaid in any financial year shall not exceed the limit from time to time under Sections 197, 198 and other applicable provisions of Companies Act, 2013 read with Schedule V thereto or otherwise as may be permissible at law.
- G. Though considering the provisions of Section 188 of the Companies Act 2013, and the applicable Rules thereunder, Mr. Praveen Kumar Maheshwari would not be holding any office or place of profit by his being a mere director of the Company's subsidiaries/Joint Ventures, approval be and is hereby granted by way of abundant caution for him to accept the sitting fees/ commission paid/payable to other directors for attending meetings of Board(s) of Directors/Committee(s) of subsidiaries/ Joint Ventures of the Company or companies promoted by the Aditya Birla Group.
- H. So long as Mr. Praveen Kumar Maheshwari functions as the Whole Time Director of the Company he shall not be subject to retirement by rotation.

**RESOLVED FURTHER THAT** if in any financial year, the Company has no profits or its profits are inadequate, the remuneration, including the perquisites as aforesaid, will be paid to Mr. Praveen Kumar Maheshwari in accordance with the applicable provisions of the Companies Act, 2013.

By Order of the Board of Directors  
For Hindalco Industries Limited

Place: Mumbai  
Date: 22<sup>nd</sup> July, 2022

Anil Malik  
Company Secretary  
Membership No.: A11197

## ANNEXURE TO NOTICE

Explanatory Statement pursuant to the provisions of Section 102 of the Companies Act, 2013

### Item No.4:

This explanatory statement is in terms of Regulation 36(5) of the SEBI (Listing Obligations and Disclosure Requirements) Regulations, 2015 ("SEBI Listing Regulations"), however, the same is not required as per Section 102 of the Act.

The Members at the Fifty-Eighth Annual General Meeting ("AGM") of the Company held on 13<sup>th</sup> September, 2017, had approved the appointment of M/s Price Waterhouse & Co. Chartered Accountants LLP with Firm (Registration No. 304026E/ E300009) (PWC), as Statutory Auditors of the Company, to hold office till the conclusion of the Sixty Third Annual General Meeting of the Company .

After evaluating and considering various factors such as industry experience, competency of the audit team, efficiency in conduct of audit, independence etc., the Board of Directors of the Company has, based on the recommendation of the Audit Committee, at its meeting held on 22<sup>nd</sup> July, 2022, proposed the re-appointment of M/s Price Waterhouse & Co. Chartered Accountants LLP (Registration No. 304026E/ E300009), as the Statutory Auditors of the Company, for a term of five consecutive years from the conclusion of Sixty-Third AGM till the conclusion of Sixty-Eighth AGM of the Company to be held in the year 2027, at a remuneration as may be mutually agreed between the Company and Statutory Auditors.

PWC have consented to their appointment as Statutory Auditors and have confirmed that if appointed, their appointment will be in accordance with Section 139 read with Section 141 of the Act.

The Board recommends the Ordinary Resolution set out at Item No. 4 of the Notice for approval by the Members.

None of the Directors and Key Managerial Personnel of the Company or their relatives is, in any way, concerned or interested in the Resolution set out at Item No. 4 of the Notice.

### Item No. 5:

The Board, on the recommendation of the Audit Committee, has approved the appointment and remuneration of M/s R. Nanabhoy & Co, Cost Accountants, Mumbai, to conduct the audit of the cost records of the Company for the financial year ending 31<sup>st</sup> March 2023.

In accordance with the provisions of Section 148 of the Companies Act, 2013, read with the Companies (Audit and Auditors) Rules, 2014, the remuneration payable to the Cost

Auditors has to be ratified by the shareholders of the Company.

Accordingly, consent of the members is sought for passing an Ordinary Resolution as set out at Item No. 5 of the accompanying Notice, for ratification of the remuneration payable to the Cost Auditors for the financial year ending 31<sup>st</sup> March, 2023.

The Board recommends the Ordinary Resolution set out at Item No. 5 of the Notice for approval by the shareholders.

None of the Directors / Key Managerial Personnel of the Company or their relatives are, in any way, concerned or interested, in the said resolution.

### Item nos. 6,7 and 8:

**Adoption of the Hindalco Industries Limited Employee Stock Option and Performance Stock Unit Scheme 2022 ("the Scheme 2022"); extending the benefits of the Scheme 2022 to employees of the group companies including holding, associate and subsidiary companies of the Company; approval for implementing the Scheme 2022 through the trust route, secondary acquisition of the equity shares of Company by the Trust and extending financial assistance /provision of money by the Company to the trust to fund the acquisition of its equity shares, in terms of the scheme 2022.**

The Board of Directors ("Board") of the Company at its meeting held on 22<sup>nd</sup> July, 2022, based upon the recommendation of the Nomination and Remuneration Committee ("NRC Committee") approved adoption of the 'Hindalco Industries Limited Employee Stock Option and performance Stock Unit Scheme 2022' ("the Scheme-2022") for the benefit of the eligible employees of the Company, and its group Company(ies) including Subsidiary Company(ies), Associate Company(ies) and Holding Company (as defined under the Securities and Exchange Board of India (Share Based Employee Benefits and Sweat Equity) Regulations, 2021 ("SEBI SBEB & SE Regulations").

The Company aims to provide competitive remuneration opportunities to its employees, including through annual incentive plans and long-term incentive plans. The Company believes that the presence of a long-term incentive plan and the resulting employee ownership can facilitate a performance driven culture and contribute to the success of the Company. The Company views stock options and units as long-term incentive instruments to enable the employees to share

the value they create for the Company in the years to come. Accordingly, the main objectives of the Scheme 2022 are:

- (i) to achieve sustained growth of the Company and create stakeholder value by aligning the interests of the employees with the long term interests of the Company;
- (ii) to attract and retain talent and as well as to motivate the employees to contribute to its growth and profitability;
- (iii) to recognise and reward the efforts of employees and their continued association with the Company and its Group Companies including associate company(ies) and Subsidiary Company(ies) and Holding Company; and
- (iv) to promote the culture of employee ownership, to enable the employees to have greater involvement in the existing plans of the Company and provide them an opportunity to share in the future growth and profitability of the Company, which should lead to improved employee engagement, motivation and retention.

The Board has nominated the NRC Committee to be designated as the Compensation Committee for the administration and superintendence of the Scheme 2022 in accordance with the SEBI SBEB & SE Regulations. Approval of the Members is being sought for grant of employee stock options ("Options") and / or performance stock units ("PSUs") (collectively "Stock Options") to the eligible employees as may be determined by the NRC Committee.

The Scheme 2022 shall be implemented through the Hindalco Employees Welfare Trust ("The Trust") The Trust will acquire Equity Shares of the Company through secondary acquisition such that the secondary acquisition in a financial year shall not exceed 2% of the paid-up equity share capital of the Company

as at the end of the previous financial year. Further, in terms of the SEBI SBEB & SE Regulations, the total Equity Shares to be held by the trust shall not exceed 5% of the paid-up equity share capital as at the end of the financial year immediately prior to the year in which the shareholder approval is obtained. As at 31<sup>st</sup> March, 2022, 5% of the paid-up equity share capital of the Company comprises of 11,23,58,636 Equity Shares.

In accordance with the SEBI SBEB & SE Regulations, approval of Members by way of special resolution is required to be passed, for adoption of the Scheme 2022 which is being implemented through a trust, extending the benefits of the Scheme 2022 to eligible employees of the group company(ies) including subsidiary company(ies), associate company(ies) and holding company and for provision of financial assistance / provision of money for secondary acquisition of equity shares of the company by the Trust. Accordingly, separate resolutions are being passed for the above.

Upon approval of the Members and after complying with the procedural and statutory formalities, the Trust is empowered to acquire in one or more tranches, upto 1,68,28,000 Equity Shares of the Company from the secondary market through the stock exchanges, representing 0.75% of the paid-up equity share capital of the Company as on 31<sup>st</sup> March, 2022, for the implementation of the Scheme 2022.

The Company will provide financial assistance / provision of money to the Trust up to ₹ 740,00,00,000 (Rupees Seven Hundred and Forty Crores only) in one or more tranches. The financial assistance / provision of money shall be interest free and will be utilised for implementation of the Scheme 2022. As and when the exercise price is recovered from the employees upon exercise of options, the Trust shall repay the money to the Company.

The relevant disclosures, as required, under Section 67 read with Rule 16 of the Companies (Share Capital and Debentures) Rules, 2014 and under the SBEB & SE Regulations and other applicable laws are as follows.

No.	Particular	Detail
(a)	A brief description of the scheme	The Company aims to provide competitive remuneration opportunities to its employees, including through annual incentive plans and long-term incentive plans. The Company believes that the presence of a long-term incentive plan and the resulting employee ownership can facilitate a performance driven culture and contribute to the success of the Company. The Scheme 2022 is being implemented through the Hindalco Employees Welfare Trust ("the Trust").
(b)	The total number of Stock Options to be granted	The aggregate number of Stock Options proposed to be granted under the Scheme 2022, shall not be exercisable into more than 1,68,28,000 equity shares equivalent to 0.75% of the overall ceiling of Equity Shares to be issued under the Scheme 2022 (which number shall be adjusted in lieu of adjustments/ re-organisation of capital structure of the Company from time to time). Upon exercise, each Stock Option entitles the relevant grantee to one Equity Share (i.e. one Option will entitle the grantee to one Equity Share and one PSU will entitle the grantee to one Equity Share).



		In case of any corporate action(s) such as rights issues, bonus issues, merger and sale of division, split or consolidation and others, a fair and reasonable adjustment needs to be made to the Stock Options granted. Accordingly, if any additional Equity Shares are issued by the Company to the grantees for making such fair and reasonable adjustment, the ceiling of 1,68,28,000 Equity Shares shall be deemed to be increased to the extent of such additional Equity Shares issued. Stock Options not vested due to non-fulfilment of the vesting conditions, vested Stock Options which the grantees expressly refuse to exercise, Stock Options (vested and not exercised and unvested) which have been surrendered and any Stock Options granted but not vested or exercised within the stipulated time due to any reasons, shall lapse and these Stock Options or the underlying Equity Shares will be available for grant under the present Scheme 2022 or under a new scheme, subject to compliance with applicable laws.
(c)	Identification of classes of employees entitled to participate and be beneficiaries in the Scheme -2022 and money is being provided for Purchase of shares.	<p>(a) An employee as designated by the company, who is exclusively working in India or outside India; or</p> <p>(b) A director of the Company, whether a whole time director or not, including a non-executive director who is not a promoter or member of the promoter group, but excluding an independent director; or</p> <p>(c) An employee as defined in sub-clauses (a) or (b) above, of a group company including subsidiary company or its associate company, in India or outside India, or of a holding company of the Company,</p> <p>but does not include—</p> <p>(1) an employee who is a promoter or belongs to the promoter group;</p> <p>(2) a director who either by himself or through his relatives or through any body corporate, directly or indirectly holds more than 10% (ten percent) of the outstanding equity shares of the Company.</p>
(d)	Requirements of vesting and period of vesting	<p>The Board or the NRC Committee may, at its discretion, lay down certain criteria including, but not limited to, the performance metrics which would include profitability, revenue, ESG metric or any other strategic metric as may be decided, on the achievement of which the granted Options would vest and which may be specified in the respective grant letters or the vesting letters to be issued in this regard.</p> <p>The Board or the NRC Committee shall lay down certain criteria including, but not limited to, the performance metrics which would include profitability, revenue, ESG metric or any other strategic metric as may be decided, on the achievement of which the granted PSUs would vest and which may be specified in the respective grant letters or the vesting letters to be issued in this regard.</p> <p>Vesting of Stock Options shall be subject to, amongst other things:</p> <p>(A) the condition that a minimum of one year has completed from grant date, except in case of death or permanent incapacity of the grantee, in which case the Stock Options, as the case may be, shall vest immediately, and</p> <p>(B) the condition that the grantee is:</p> <p>(i) in continuous employment with the Company or group company(ies) including subsidiary company (ies) or associate company(ies) or holding company;</p> <p>(ii) is not serving any notice of resignation / termination on the date of such vesting (except in case of (a) death of employee (b) permanent incapacity suffered by the grantee; (c) retirement; or (d) transfer or deputation to a group company, including holding company, subsidiary company, or an associate company); and</p>

		<p>(iii) is not subject to any pending disciplinary proceeding.</p> <p>In case of cessation of employment due to retirement or superannuation, Stock Options granted to such employees would continue to vest in accordance with the respective Vesting Schedules even after retirement or superannuation, subject to the discretion of NRC Committee, and in accordance with the Company's policies, and Applicable Laws.</p> <p>Vesting Period for Stock Options: The Stock Options granted shall vest not earlier than one year in one or more tranche and not later than four years from the date of grant for Stock Options or such other period as may be determined by the NRC Committee. The vesting schedule (i.e. exact proportion in which and the exact period over which the Options would vest) would be determined by the NRC Committee, subject to the minimum vesting period of one year from the date of grant of Stock Options (except in case of death and permanent incapacity).</p>
(e)	The maximum period within which the Stock Options shall be vested.	4 (four) years
(f)	Exercise price	<p>Exercise price for Options: The Equity Shares to be transferred pursuant to the exercise of the Options would be transferred at the market price of the equity shares at the time of grant of Options or at such other price as may be decided by the NRC Committee from time to time in compliance with the SEBI SBEB &amp; SE Regulations. Provided that the exercise price per Option shall not be less than the face value of the equity share of the Company</p> <p>Exercise price for PSUs: Upon exercise of the PSUs the Equity Shares may be transferred at face value of the equity share of the Company or at such price as may be determined by the Board or NRC Committee provided that the exercise price per PSU shall not be less than the face value of the equity share of the Company.</p>
(g)	Exercise period and process of exercise	<p>The exercise period shall not be more than a period of five years from the date of vesting of Stock Options or such other period as may be determined by the NRC Committee, subject to applicable law.</p> <p>The Stock Options will be exercisable by the employees through a written application to the Company / Trust accompanied by payment of the exercise price in such manner and on execution of such documents, as may be prescribed by the NRC Committee from time to time. The Stock Options will lapse if not exercised within the specified exercise period.</p>
(h)	The appraisal process for determining the eligibility of employees for the scheme	The appraisal process for determining the eligibility criteria of the employees will be specified by the NRC Committee, and will be based on criteria such as role/level of the employee, past performance record, future potential of the employee, and/or such other criteria that may be determined by the NRC Committee at its sole discretion.
(i)	The maximum number of Stock Options to be issued per employee and in aggregate.	<p>The maximum number of Stock Options and PSUs that can be granted to single employee under the Scheme 2022 shall not exceed 1 % of the paid – up equity share capital of the Company at the time of grant.</p> <p>The maximum number of Stock Options and PSUs that can be granted in aggregate is 1,68,28,000 equity shares, being 0.75 % of the paid- up equity share capital of the Company as on 31<sup>st</sup> March 2022.</p>
(j)	The maximum quantum of benefits to be provided per employee under a scheme.	Apart from grant of Stock Options and PSUs as stated above in item (i), no monetary benefits are contemplated under the Scheme 2022.

(k)	Whether the scheme(s) is to be implemented and administered directly by the company or through a trust.	The Scheme 2022 will be implemented through the Hindalco Employees Welfare Trust.																									
(l)	The particulars of the trustee in whose favour such shares are to be registered	Same as (m) below																									
(m)	The particulars of name, address of the trust, trustees, occupation and nationality of trustees and their relationship with the promoters, directors and key managerial personnel	<p>(1) Name : Hindalco Employees Welfare Trust</p> <p>(2) Address of the Trust: 1<sup>st</sup> Floor, Ahura Centre, B Wing, Mahakali Caves Road, Andheri (East), Mumbai : 400093.</p> <p>(3) Trustees:</p> <table border="1" data-bbox="457 610 1391 949"> <thead> <tr> <th>Sr. No.</th> <th>Name</th> <th>Occupation</th> <th>Address</th> <th>Nationality</th> </tr> </thead> <tbody> <tr> <td>1</td> <td>Mr. SK Chatterjee</td> <td>Service</td> <td>2<sup>nd</sup> Floor, B Wing, Mahakali Caves Road, Andheri: 400093</td> <td>Indian</td> </tr> <tr> <td>2</td> <td>Mr. Mukesh Agarwal</td> <td>Service</td> <td>2<sup>nd</sup> Floor, B Wing, Mahakali Caves Road, Andheri: 400093</td> <td>Indian</td> </tr> <tr> <td>3</td> <td>Ms. Anupama Mohan</td> <td>Service</td> <td>Aditya Birla Centre, 3<sup>rd</sup> Floor, A Wing, S K Ahire Marg, Worli: 400 030.</td> <td>Indian</td> </tr> <tr> <td>4</td> <td>Mr. Jayant Jain</td> <td>Service</td> <td>Aditya Birla Capital Limited , One India Bulls Centre, Tower-1, Senapati Bapat Marg, Mumbai: 400013.</td> <td>Indian</td> </tr> </tbody> </table> <p>None of the above Trustees and their respective relatives are related to Promoters, Directors and Key Managerial Personnel of the Company. Subject to the compliance of the provisions of applicable law, the aforesaid Trustees may be changed at any time. In accordance with the SEBI SBEB &amp; SE Regulations, none of the Trustees hold 10% or more beneficial interest in the Company.</p>	Sr. No.	Name	Occupation	Address	Nationality	1	Mr. SK Chatterjee	Service	2 <sup>nd</sup> Floor, B Wing, Mahakali Caves Road, Andheri: 400093	Indian	2	Mr. Mukesh Agarwal	Service	2 <sup>nd</sup> Floor, B Wing, Mahakali Caves Road, Andheri: 400093	Indian	3	Ms. Anupama Mohan	Service	Aditya Birla Centre, 3 <sup>rd</sup> Floor, A Wing, S K Ahire Marg, Worli: 400 030.	Indian	4	Mr. Jayant Jain	Service	Aditya Birla Capital Limited , One India Bulls Centre, Tower-1, Senapati Bapat Marg, Mumbai: 400013.	Indian
Sr. No.	Name	Occupation	Address	Nationality																							
1	Mr. SK Chatterjee	Service	2 <sup>nd</sup> Floor, B Wing, Mahakali Caves Road, Andheri: 400093	Indian																							
2	Mr. Mukesh Agarwal	Service	2 <sup>nd</sup> Floor, B Wing, Mahakali Caves Road, Andheri: 400093	Indian																							
3	Ms. Anupama Mohan	Service	Aditya Birla Centre, 3 <sup>rd</sup> Floor, A Wing, S K Ahire Marg, Worli: 400 030.	Indian																							
4	Mr. Jayant Jain	Service	Aditya Birla Capital Limited , One India Bulls Centre, Tower-1, Senapati Bapat Marg, Mumbai: 400013.	Indian																							
(n)	Whether the scheme(s) involves new issue of shares by the company or secondary acquisition by the trust or both.	The Scheme 2022 will only involve secondary acquisition of equity shares by the Trust through the recognised stock exchanges. The secondary acquisition of equity shares will be undertaken in compliance with the SEBI SBEB & SE Regulations and other applicable laws.																									
(o)	The amount of loan to be provided for implementation of the scheme(s) by the company to the trust, its tenure, utilization, repayment terms, etc.	The Company shall make interest free financial assistance /provision of money for an amount upto ₹ 740,00,00,000 (Rupees Seven Hundred and Forty Crores only) in one or more tranches to fund the acquisition of Equity Shares by the Trust from the stock exchanges through secondary acquisition, in terms of the Scheme 2022. The Exercise price received from the employees upon exercise of Stock Options shall be used for the purposes of repayment to the Company.																									
(p)	The maximum percentage of secondary acquisition (subject to limits specified under the regulations) that can be made by the trust for the purposes of the scheme(s).	The Trust may acquire equity shares through secondary acquisition such that secondary acquisition in a financial year shall not exceed 2% of the paid-up equity share capital of the Company as at the end of the previous financial year.																									

(q)	A statement to the effect that the company shall conform to the accounting policies specified in Regulation 15 of the SEBI SBEB & SE Regulations.	The Company shall follow the accounting policies specified in Regulation 15 of the SEBI SBEB & SE Regulations. In addition, the Company shall disclose such details as required under the Applicable Laws.
(r)	The method which the company shall use to value its options.	To calculate the employee compensation cost, the Company shall use the Fair Value Method for valuation of the Stock Options granted or such valuation method as may be prescribed from time to time in accordance with Applicable Laws.
(s)	Transferability of Stock Options	The Stock Options granted to an employee will not be transferable to any person and shall not be pledged, hypothecated, mortgaged or otherwise alienated in any manner.
(t)	Any interest of the key managerial personnel, directors or promoters in the Scheme 2022 or Trust and effect thereof	The Promoters and Promoter Group are not interested in the Scheme 2022 or the Trust. Directors and Key Managerial Personnel may be deemed to be interested to the extent of Stock Options as may be offered to them under the Scheme 2022.
(u)	The detailed particulars of benefits which will accrue to the employees from the implementation of the Scheme 2022	The employees can exercise Stock Options granted to them to get equity shares.
(v)	Details about who would exercise and how the voting rights in respect of the shares to be acquired under the Scheme 2022 would be exercised	The Trustees shall not exercise voting rights in respect of the Equity Shares held by the Trust pursuant to the Scheme 2022. The SEBI SBEB & SE Regulations provides that the Trustees of the Trust, which is governed under the SEBI SBEB & SE Regulations, shall not vote in respect of the shares held by such Trust, so as to avoid any misuse arising out of exercising such voting rights.

Pursuant to Section 102 of the Companies Act, 2013, the Board of Directors of the Company do hereby confirm that none of its Directors or Key Managerial Personnel (as defined under the Act) and their immediate relatives is concerned or interested, financially or otherwise, except to the extent that the stock options may be granted to them pursuant to the Scheme 2022.

The Board accordingly recommends the resolutions set out at item no. 6,7 and 8 of this Notice for your approval.

#### Item No.9

Mr. Praveen Kumar Maheshwari (DIN: 00174361) joined the Company as its Chief Financial Officer in December 2011. In this role, he is responsible for providing strategic leadership on financial matters across all operations of Hindalco with a focus on enhancing shareholder value. He plays a key role in various strategic decisions of the Company and its subsidiaries. At Hindalco he oversees various functions including Treasury, Accounts, Secretarial, Taxation, Risk Management, Investor Relations and Information Technology. He also worked as the

CEO of Copper business of the Company from 1<sup>st</sup> July 2019 to 30<sup>th</sup> April 2021.

Mr. Maheshwari was appointed as a Whole Time Director for a term of 5 years w.e.f. 28<sup>th</sup> May, 2016. Considering the contributions made by Mr. Maheshwari and based on the recommendation of the Nomination and Remuneration Committee, the Board of Directors in the meeting held on 21<sup>st</sup> May, 2021. Further subject to shareholders' approval and Central Government approval, if required, re-appointed Mr. Maheshwari as a Whole-time Director of the Company for a second term of one year with effect from 28<sup>th</sup> May, 2022 for which the resolution as in this item of the Notice is proposed for your approval.

Mr. Maheshwari satisfies all conditions as per the Companies Act, 2013 for being eligible for his reappointment and is not disqualified for being appointed as the Whole time Director.

The remuneration of the Whole-time Director as set out in the resolution is in line with the trend prevailing in the corporate

sector in the Country. The details of the last remuneration drawn by Mr. Maheshwari are provided in the Corporate Governance section and Annexure III to Directors' Report of the Integrated Annual Report.

The terms and conditions of the appointment of Mr. Maheshwari including the aforesaid documents, shall be electronically available for inspection by the Members, without payment of any fees, from the date of circulation of this Notice up to the date of AGM, i.e. Tuesday, 23<sup>rd</sup> August, 2022. Members seeking inspection of the aforementioned documents can send an email to [hilinvestors@adityabirla.com](mailto:hilinvestors@adityabirla.com).

Save and except Mr. Praveen Kumar Maheshwari and his relatives, to the extent of their shareholding interest, if any, in the Company, none of the other Directors/Key Managerial Personnel of the Company or their relatives are, in any way, concerned or interested, financially or otherwise, in the resolution set out at Item No. 9 of the Notice.

The brief resume in relation to the experience, functional expertise, memberships on other Companies' Boards and Committees in respect of Mr. Praveen Kumar Maheshwari, as required under Regulation 36 of the Securities and Exchange Board of India (Listing Obligations and Disclosure Requirements) Regulations, 2015 are set out in this Notice as an Annexure.

The Board of Directors accordingly recommends the resolution as set out in Item No. 9 of the Notice for your approval.

By Order of the Board of Directors  
For Hindalco Industries Limited

Place: Mumbai  
Date: 22<sup>nd</sup> July, 2022

Anil Malik  
Company Secretary  
Membership No.: A11197



## Annexure

### Details of Directors seeking appointment and re-appointment in Annual General Meeting to be held on 23<sup>rd</sup> August, 2022

#### A. Brief Resume including qualification, experience and expertise in specific functional area:

##### a. Mr. Kumar Mangalam Birla:

**Kumar Mangalam Birla** was appointed as a Non-Executive Chairman of our Company with effect from 19<sup>th</sup> October, 1995. He is the Chairman of the Board of Directors of your Company and the Chairman of Aditya Birla Group ("Group"), which operates in 36 countries across six continents. He is a Chartered Accountant and holds an MBA degree from the London Business School. Mr. Birla chairs the Boards of all major Group companies in India and globally. In the 27 years that he has been at the helm of the Group, he has accelerated growth, built meritocracy, and enhanced stakeholder value. In the process he has raised the Group's turnover by over 25 times. He has been the architect of over 40 acquisitions in India and globally, among the highest by any Indian multinational. Under his stewardship, the Group enjoys a position of leadership in all the major sectors in which it operates, from cement to chemicals, metals to textiles, and apparels to financial services. Over the years, Mr. Birla has built a highly successful meritocratic organization, anchored by an extraordinary force of 140,000 employees belonging to 100 different nationalities. Outside the Group, Mr. Birla has held several key positions on various regulatory and professional Boards. He was a Director on the Central Board of Directors of the Reserve Bank of India. He was Chairman of the Advisory Committee constituted by the Ministry of Company Affairs and also served on the Prime Minister of India's Advisory Council on Trade and Industry. As the Chairman of the Securities Exchange Board of India Committee on Corporate Governance, he framed the first-ever governance code for Corporate India.

Over the years, Mr. Birla has been conferred several

prestigious awards. In 2021, he received the TiE Global Entrepreneurship Award for Business Transformation, the first Indian business leader to receive this honour. He is also the first Indian Industrialist to be conferred an Honorary degree by the Institute of Company Secretaries of India. Mr. Birla is deeply engaged with Educational Institutions. He is the Chancellor of the Birla Institute of Technology & Science ("BITS") with campuses in Pilani, Goa, Hyderabad and Dubai. He is also the Chairman of India's premier management institute - Indian Institute of Management, Ahmedabad. On the global arena, Mr. Birla is an Honorary Fellow of the London Business School. In 2019, Mr. Birla constituted a £15mn scholarship programme at the London Business School in memory of his grandfather, Mr. B. K. Birla, marking the largest ever endowed scholarship gift to a European Business School. A firm practitioner of the trusteeship concept, Mr. Birla has institutionalized the concept of caring and giving at the Group. With his mandate, the Group is involved in meaningful welfare driven activities that distinctively enrich the lives of millions.

##### b. Mr. Praveen Kumar Maheshwari

**Praveen Kumar Maheshwari** is a Whole Time Director and Chief Financial Officer of the Company. He joined the Company as its Chief Financial Officer in December 2011. He was inducted in the Board as the Whole Time Director in May 2016. He also worked as the CEO of Copper business of the Company for the period from 1<sup>st</sup> July 2019 to 30<sup>th</sup> April 2021. Mr. Maheshwari, a Chartered Accountant with an MBA from IIM - Ahmedabad, has over 39 years of work experience in areas of General Management and Finance, including mergers & acquisitions, fundraising, investor relations in India and global financial markets. Prior to joining Hindalco, he has worked with a number of business houses engaged in different industries. His last assignment before joining the Company was as Group CFO & Executive Director – Finance of Bharat Forge Limited. He is reappointed for a period of one year w.e.f 28<sup>th</sup> May 2022 by the Board of Directors subject to necessary approval by shareholders.

**B. Other Details (as on 22<sup>nd</sup> July,2022)**

<b>Name of Director</b>	<b>Mr. Kumar Mangalam Birla</b>	<b>Mr. Praveen Kumar Maheshwari</b>
<b>Date of Birth; Age</b>	14/06/1967, 55 years	18/02/1961, 61 years
<b>Date of Appointment</b>	16/11/1992	28/05/2021
<b>Expertise in specific functional areas</b>	Industrialist	Finance
<b>Qualifications</b>	C.A., MBA	C.A., MBA (IIM-A)
<b>Relationship with other Directors, Managers and Key Managerial Personnel of the Company</b>	Son of Mrs. Rajashree Birla	Nil
<b>No. of Board meetings attended during FY 22</b>	7	7
<b>@List of outside Directorships held-Listed (L) and Unlisted (UL)</b>	<ol style="list-style-type: none"> <li>1. UltraTech Cement Ltd (L)</li> <li>2. Aditya Birla Capital Ltd (L)</li> <li>3. Aditya Birla Sunlife AMC Ltd (L)</li> <li>4. Century Textiles and Industries Ltd (L)</li> <li>5. Grasim Industries Ltd (L)</li> <li>6. Aditya Birla Fashion and Retail Limited (L)</li> <li>7. Aditya Birla Sunlife Insurance Co. Ltd (UL)</li> </ol>	<ol style="list-style-type: none"> <li>1. Utkal Alumina International Ltd. (UL)</li> </ol>
<b>Listed Entities from which he has resigned as Director in past 3 years</b>	<ol style="list-style-type: none"> <li>1. Vodafone Idea Limited</li> <li>2. Air India Limited</li> </ol>	<ol style="list-style-type: none"> <li>1. Hindalco Almix- Aerospace Limited</li> </ol>
<b>Pursuant to SEBI (Listing Regulations and Disclosures Requirement) Regulations, 2015 only two Committees viz. Audit Committee and Stakeholders' Relationship Committee are considered.</b>	Nil	Nil
<b>*Chairman/ Member of the Committee of the Board of Directors of other companies in which he/ she is a Director.</b>		
<b>a. Audit Committee</b>	Nil	Nil
<b>b. Stakeholders' Relationship Committee</b>	Nil	Nil
<b>#Including Shareholding as a Beneficial Owner.</b>	**901635	Nil

**Note:**

\*\* Including Shares held as Father and Natural Guardian of Ms. Ananyashree Birla. Additionally, he holds 6,48,632 equity shares as Karta of Aditya Vikram Kumar Mangalam Birla HUF.

@ In terms of the applicable provisions of the Act and SEBI Listing Regulations, total number of directorships:

- a. consist of directorships in all public limited companies (including deemed public company), whether listed or not;
- b. excludes this company, foreign companies, private limited companies and companies formed under section 25 of the erstwhile Companies Act, 1956 and under section 8 of the Act.

## NOTES:

### GENERAL:

1. In Pursuant to the General Circulars 2/2022 and 19/2021, other circulars issued by the Ministry of Corporate Affairs (MCA) and Circular SEBI/HO/CFD/CMD2/CIR/P/2022/62 dated May 13, 2022 issued by SEBI (hereinafter collectively referred to as "the Circulars"), companies are allowed to hold Annual General Meeting ('AGM') through video-conferencing ('VC')/ other audio-visual means (OAVM), without the physical presence of members at a common venue. Hence, in compliance with the Circulars, the AGM of the Company is being held through VC.
2. Pursuant to the provisions of the Companies Act, 2013, a member entitled to attend and vote at the AGM is entitled to appoint a proxy to attend and vote on his / her behalf and the proxy need not be a member of the Company. Since the AGM is being held in pursuant to the Circulars through VC/OAVM, physical attendance of the Members has been dispensed with. Accordingly, the facility for appointment of proxies by the Members will not be available for the AGM and hence the Proxy Form and Attendance Slip are not annexed to this Notice.
3. An Explanatory Statement pursuant to Section 102 of the Act, in respect of Item nos. 4 to 9 of the Notice set out above, is annexed hereto. The Board of Directors have considered and decided to include item nos. 5 to 9 as Special Business. The relevant details, pursuant to Regulation 36(3) of the Listing Regulation and Secretarial Standard on General Meetings issued by the Institute of Company Secretaries of India ('ICSI') in respect of Director seeking re-appointment at this AGM is annexed to this Notice.
4. In accordance with the Secretarial Standard – 2 on General Meetings issued by the ICSI read with Clarification / Guidance on applicability of Secretarial Standards - 1 and 2 dated 15<sup>th</sup> April, 2020 issued by the ICSI, the proceedings of the AGM shall be deemed to be conducted at the Registered office of the Company i.e. Ahura Centre, 1<sup>st</sup> Floor, 'B' Wing, Mahakali Caves Road, Andheri (East), Mumbai 400 093 which shall be the venue of the AGM. Since the AGM will be held through VC / OAVM, the Route Map is not annexed in this Notice.
5. Members attending the AGM through VC / OAVM shall be counted for the purpose of reckoning the quorum under Section 103 of the Act.
- i. The Register of Directors and Key Managerial Personnel and their shareholding, maintained under Section 170 of the Act, the Register of Contracts or Arrangements in which the Directors are interested, maintained under Section 189 of the Act, the certificate from the statutory auditors of the Company certifying that the ESOS Schemes of the Company are being implemented in accordance with the SEBI (Share Based Employee Benefits) Regulations, 2014 will be available for inspection by the Members through electronic mode during the AGM. The aforesaid documents along with documents referred to in the Notice will also be available electronically for inspection by the Members, without payment of any fees, from the date of circulation of this Notice up to the date of AGM, i.e. Tuesday, 23<sup>rd</sup> August, 2022. Members seeking inspection of the aforementioned documents can send an email to [hilinvestors@adityabirla.com](mailto:hilinvestors@adityabirla.com).
6. I. The Company has listed its shares at:
  - a) BSE Limited,  
Phiroze Jeejeebhoy Towers,  
Dalal Street, Mumbai – 400 001.
  - b) The National Stock Exchange of India Limited,  
5<sup>th</sup> Floor, Exchange Plaza,  
Plot No. C/1, G Block,  
Bandra-Kurla Complex,  
Bandra (E), Mumbai- 400 051.II. The Company has listed its Debentures at:  
The National Stock Exchange of India Limited,  
5<sup>th</sup> Floor, Exchange Plaza,  
Plot No. C/1, G Block,  
Bandra-Kurla Complex,  
Bandra (E), Mumbai – 400 051.

The listing fees of these Exchanges have been paid in time.
- 6 A The Members can join the AGM in VC/OAVM mode 30 minutes before and after the time scheduled for the AGM and shall be kept open throughout the AGM. The facility of participation at the AGM through VC/OAVM will be made available for minimum 1,000 members on 'first come first serve' basis. This will not include large Shareholders (Shareholders holding 2% or more equity shares), Promoters, Institutional Investors, Directors, key managerial Personnel, the Chairpersons of the Audit Committee, Nomination and Remuneration Committee

and Stakeholders' Relationship Committee, Auditors etc. who are allowed to attend AGM without restriction on account of 'first come first serve' basis.

#### **DISPATCH OF ANNUAL REPORT:**

7. In compliance with the aforesaid MCA Circulars and SEBI Circulars, Notice of the AGM along with the Integrated Annual Report 2021-22 is being sent only through electronic mode to those Members whose email addresses are registered with the Company/ Depositories. Members may note that the Notice and Integrated Annual Report 2021-22 will also be available on the Company's website [www.hindalco.com](http://www.hindalco.com) and websites of the Stock Exchanges i.e. BSE Limited and National Stock Exchange of India Limited at [www.bseindia.com](http://www.bseindia.com) and [www.nseindia.com](http://www.nseindia.com) respectively, and AGM notice is also available on NSDL website i.e. [www.evoting.nsdl.com](http://www.evoting.nsdl.com).

#### **DECLARATION OF RESULT:**

8. The Board of Directors has appointed Mr. B. Narasimhan, Proprietor, BN & Associates, Company Secretaries as a Scrutinizer to scrutinize the remote e-voting process and e-voting at the AGM in a fair and transparent manner.
9. The Scrutinizer shall, immediately after the conclusion of voting at the AGM, first count the votes cast during the AGM, thereafter unblock the votes cast through remote e-voting and make, not later than 48 hours of conclusion of the AGM, a consolidated Scrutinizer's Report of the total votes cast in favour or against, if any, to the Chairman or a person authorised by him in writing, who shall countersign the same.
10. The result declared along with the Scrutinizer's Report shall be placed on the Company's website [www.hindalco.com](http://www.hindalco.com) and on the website of NSDL <https://www.evoting.nsdl.com> immediately. The Company shall simultaneously forward the results to National Stock Exchange of India Limited and BSE Limited, where the shares of the Company are listed.

#### **BOOK CLOSURE:**

11. The Register of Members and Transfer Books in respect of Equity Shares of the Company will remain closed from Tuesday, 16<sup>th</sup> August, 2022 to Monday, 22<sup>nd</sup> August, 2022 (both days inclusive) for the purpose of payment of dividend.
12. SEBI has mandated the submission of PAN, KYC and nomination details by Members holding shares in

physical form by 31<sup>st</sup> March, 2023. Shareholders are requested to submit their PAN, KYC and nomination details at the registered office of the Company or e-mail at [hilinvestors@adityabirla.com](mailto:hilinvestors@adityabirla.com) with e-signed documents. The forms for updating the same are available at Company's website i.e. [www.hindalco.com](http://www.hindalco.com)

In case a holder of physical securities fails to furnish these details before the due date, the Company shall freeze such folios. The securities in the frozen folios shall be eligible to receive payments (including dividend) and lodge grievances only after furnishing the complete documents. If the securities continue to remain frozen as on 31<sup>st</sup> December, 2025, the Company shall refer such securities to the administering authority under the Benami Transactions (Prohibitions) Act, 1988, and / or the Prevention of Money Laundering Act, 2002. Members holding shares in electronic form are requested to submit their PAN to their Depository Participant(s).

#### **PAYMENT OF DIVIDEND:**

14. The final dividend, as recommended by the Board of Directors, if approved at the AGM, payment of such dividend subject to deduction of tax at source will be made on or after Tuesday, 23<sup>rd</sup> August, 2022 as under:
  - (i) To all Beneficial Owners in respect of shares held in dematerialized form as per the data as may be made available by the National Securities Depository Limited ("NSDL") and the Central Depository Services (India) Limited ("CDSL"), as of the close of business hours on Friday, 12<sup>th</sup> August, 2022;
  - (ii) To all Members in respect of shares held in physical form after giving effect to transmission or transposition requests, change of name lodged with the Company as of the close of business hours on Friday, 12<sup>th</sup> August, 2022 .

Equity shares that may be allotted upon the exercise of stock options granted under the Employee Stock Option Scheme before the book closure date shall rank pari passu with the existing equity shares and shall be entitled to receive the dividend, if approved at the meeting.

The Company shall make the payment of dividend to those Members directly in their bank accounts whose bank account details are available with the Company and those who have given their mandate for receiving dividends directly in their bank accounts through the Electronic Clearing Service ("ECS") / National Electronic Clearing Service ("NECS").

In terms of the MCA and SEBI Circulars, in case, the Company is unable to pay dividend to any Member by the electronic mode, due to non-availability of the details of the bank account, the Company shall dispatch the dividend warrant to such Member by post.

15. Members holding shares in dematerialized form are requested to intimate all changes pertaining to their bank details, National Electronic Clearing Service (NECS), Electronic Clearing Service (ECS), mandates, nominations, power of attorney, change of address, change of name, e-mail address, contact numbers, etc., to their Depository Participant (DP). Changes intimated to the DP will then be automatically reflected in the Company's records which will help the Company to provide efficient and better services. Members holding shares in physical form are requested to intimate such changes to the Company by email to [hilinvestors@adityabirla.com](mailto:hilinvestors@adityabirla.com).
16. To avoid the incidence of fraudulent encashment of dividend warrants, Members are requested to intimate the Company under the signature of the Sole / First Joint holder, the following information, so that the bank account number and name and address of the bank can be printed on the dividend warrants:
  - Name of Sole / First Joint holder and Folio number.
  - Particulars of bank account, viz.
    - i) Name of bank
    - ii) Name of branch
    - iii) Complete address of bank with PINCODE
    - iv) Account type, whether Savings (SB) or Current Account (CA)
    - v) Bank Account Number

Further, in case Members have not updated their bank account details, please do so by sending a copy of a cancelled cheque leaf (self-attested), with name, bank account number, bank address and IFSC code printed thereon. In case the cheque leaf does not contain the aforesaid details, please submit a copy of the first page of the bank account passbook showing the aforesaid details, duly attested and signed by the bank manager.

#### **DEDUCTION OF TAX AT SOURCE ON DIVIDEND:**

17. Pursuant to Finance Act 2020, dividend income will be taxable in the hands of shareholders w.e.f. 01<sup>st</sup> April, 2020 and the Company is required to deduct tax at source from dividend paid to shareholders at the prescribed

rates. For the prescribed rates for various categories, the shareholders are requested to refer to the Finance Act, 2020 and amendments thereof. The shareholders are requested to update their PAN with the Company (in case of shares held in physical mode) and depositories (in case of shares held in demat mode).

A Resident individual shareholder with PAN and who is not liable to pay income tax can submit a yearly declaration in Form No. 15G/15H. To avail the benefit of non-deduction of tax at source, the documents are to be submitted through URL <https://onehindalco.adityabirla.com/hilapex/shareholder> (You may access this link in browser Google chrome or Micro Soft Edge by entering Folio No./DP ID & Client ID) or email to [hiltlds@adityabirla.com](mailto:hiltlds@adityabirla.com) by 05<sup>th</sup> August, 2022. Shareholders are requested to note that in case their PAN is not registered, the tax will be deducted at a higher rate of 20%.

Non-resident shareholders can avail beneficial rates under tax treaty between India and their country of residence, subject to providing necessary documents i.e. No Permanent Establishment and Beneficial Ownership Declaration, Tax Residency Certificate, Form 10F, any other document which may be required to avail the tax treaty benefits by uploading the documents at aforesaid link or sending an email to [hiltlds@adityabirla.com](mailto:hiltlds@adityabirla.com). The aforesaid declarations and documents need to be submitted by the shareholders by 5<sup>th</sup> August, 2022

#### **UNPAID DIVIDEND AND SHARES & TRANSFER TO IEPF ACCOUNT:**

18. Pursuant to the provisions of Section 124 of the Companies Act, 2013 the unpaid/unclaimed dividend and Equity Shares related to unclaimed dividend for the financial year 2013-2014 has been transferred by the company to the Investor Education Protection Fund ("IEPF") established by the Central Government.

In terms of the provisions of Section 125(5) of the Act, dividend which remains unpaid/unclaimed for a period of seven years from the date of declaration will be transferred to the IEPF.

Further, in terms of the provisions of the Investor Education and Protection Fund Authority (Accounting, Audit, Transfer and Refund) Rules, 2016 ("IEPF Rules"), and amendment thereof the equity shares in respect of which dividend has not been paid or claimed for seven consecutive years of more from the date of declaration will also be transferred to an account viz. "Investor Education and Protection Fund Authority Ministry



of Corporate Affairs”, which is operated by the IEPF Authority pursuant to the IEPF Rules.

The unclaimed dividend amount for the financial year 2013-2014 and 3,87,767 Equity Shares related to unclaimed dividend for the financial year have been credited to Investor Education and Protection Fund (IEPF).

Shareholder can claim the unclaimed dividend amounts and shares credited to IEPF with a separate application made to the IEPF Authority, in Form IEPF-5, as prescribed under the Rules and are available at IEPF website i.e [www.iepf.gov.in](http://www.iepf.gov.in).

Shareholders, who have so far not encashed their dividend relating to the financial year 2014-15 are requested to do so by 15<sup>th</sup> September, 2022 by writing to the Secretarial Department at the Registered Office of the Company, failing which the dividend and the equity shares relating thereto will be transferred to the “Investor Education and Protection Fund Authority Ministry of Corporate Affairs”.

In compliance with the aforesaid Rules, the Company has already transferred equity shares for which dividend remained unpaid/unclaimed for a period of seven years from the date of declaration to the Investor Education and Protection Fund Authority Ministry of Corporate Affairs, after providing necessary intimations to the relevant shareholders. Details of unpaid/unclaimed dividend and such equity shares are uploaded on the website of the Company as well as that of the Ministry of Corporate Affairs, Government of India (“MCA”). No claim shall lie against the Company in respect of unclaimed dividend amount and equity shares transferred to the Investor Education and Protection Fund Authority and Ministry of Corporate Affairs, respectively, pursuant to the IEPF Rules. Members can however claim both the unclaimed dividend amount and equity shares from the IEPF Authority by making applications in the manner provided in the IEPF Rules.

Pursuant to Rule 5(8) of Investor Education and Protection Fund Authority (Accounts, Audit, Transfer and Refund) Rules, 2016, (‘IEPF Rules’) the Company has uploaded details of unpaid and unclaimed amounts lying with the Company on the website of the Company [www.hindalco.com](http://www.hindalco.com).

#### **DEPOSITORY SYSTEM:**

19. As per Regulation 40 of SEBI Listing Regulations, as amended, securities of listed companies can be

transferred only in dematerialized form with effect from, 01<sup>st</sup> April, 2019, except in case of request received for transmission or transposition of securities. In view of this and to eliminate all risks associated with physical shares and for ease of portfolio management, members holding shares in physical form are requested to consider converting their holdings to dematerialized form. Members can contact the Company in case of any queries by sending email to [hilinvestors@adityabirla.com](mailto:hilinvestors@adityabirla.com).

In terms of the Listing Regulations, it is mandatory to furnish a copy of PAN card to the Company in the following cases viz. deletion of name, transmission of shares and transposition of shares.

20. As per the provisions of Section 72 of the Act, facility for making nominations is now available to INDIVIDUALS holding shares in the Company. Members holding shares in physical form may obtain the Nomination Form from the Company’s Secretarial Department at its Registered Office. Members holding shares in electronic form have to approach their DPs for completing the nomination formalities.
21. Members are requested to make all correspondence in connection with the shares held by them by addressing letters directly to the Company quoting their Folio number or their Client ID number with DP ID number, as the case may be.
22. Shareholders are requested to read the “Shareholders’ Information” Section of the Integrated Annual Report for useful information.
23. In compliance with the provisions of Section 108 of the Act, read with the Companies (Management and Administration) Rules, 2014 as amended by the Companies (Management and Administration) Amendment Rules, 2015 and Regulation 44 of SEBI Listing Regulations and MCA circulars, the Company is pleased to provide its members the facility to cast their vote by electronic means on all resolutions set forth in this Notice. The Company has appointed National Securities Depository Limited (‘NSDL’) for facilitating voting through electronic means, as the authorized agency. The Members may cast their votes using an electronic voting system from a place other than the venue of the AGM (‘remote e-voting’). The instructions for e-voting are enclosed with this Notice.
24. In line with the Ministry of Corporate Affairs (MCA) Circular No. 17/2020 dated April 13, 2020, the Notice

calling the AGM has been uploaded on the website of the Company at [www.hindalco.com](http://www.hindalco.com). The Notice can also be accessed from the websites of the Stock Exchanges i.e. BSE Limited and National Stock Exchange of India Limited at [www.bseindia.com](http://www.bseindia.com) and [www.nseindia.com](http://www.nseindia.com) respectively and the AGM Notice is also available on the website of NSDL (agency for providing the Remote e-Voting facility) i.e. [www.evoting.nsdl.com](http://www.evoting.nsdl.com).

25. AGM has been convened through VC/OAVM in compliance with applicable provisions of the Companies Act, 2013 read with MCA Circular No. 14/2020 dated April 08, 2020 and MCA Circular No. 17/2020 dated April 13, 2020, MCA Circular No. 20/2020 dated May 05, 2020 and MCA Circular No. 2/2021 dated January 13, 2021.

#### **PROCEDURE FOR REMOTE E-VOTING AND VOTING DURING AGM:**

26. Members are requested to attend and participate in the ensuing AGM through VC / OAVM and cast their vote either through remote e-voting facility or through e-voting facility to be provided during the AGM.
27. The facility of e-voting during the AGM will be available to those Members who have not cast their vote by remote e-voting. Members, who have cast their vote by remote e-voting, may attend the AGM through VC / OAVM but will not be entitled to cast their vote once again on resolutions.
28. The remote e-voting period commences on Saturday, 20<sup>th</sup> August, 2022 at 09:00 A.M. and ends on Monday, 22<sup>nd</sup> August, 2022, at 05:00 P.M. The remote e-voting module shall be disabled by NSDL for voting thereafter. The Members, whose names appear in the Register of Members / Beneficial Owners as on the record date (cut-off date) i.e. 16<sup>th</sup> August, 2022, may cast their vote electronically. The voting right of shareholders shall be in proportion to their share in the paid-up equity share capital of the Company as on the cut-off date, being 16<sup>th</sup> August, 2022.
29. Members are encouraged to join the Meeting through Laptops for better experience.
30. Further Members will be required to allow Camera and use Internet with a good speed to avoid any disturbance during the meeting.
31. Please note that Participants Connecting from Mobile Devices or Tablets or through Laptop connecting via

Mobile Hotspot may experience Audio/Video loss due to Fluctuation in their respective network. It is therefore recommended to use Stable Wi-Fi or LAN Connection to mitigate any kind of aforesaid glitches.

32. Shareholders who would like to express their views/ask questions during the meeting may register themselves as a speaker and may send their request mentioning their name, demat account number/folio number, email id, mobile number at [hilinvestors@adityabirla.com](mailto:hilinvestors@adityabirla.com) during the period Tuesday, 16<sup>th</sup> August, 2022 at 09:00 A.M. to Thursday, 18<sup>th</sup> August, 2022 at 05:00 P.M.
33. Shareholders who would like to express their views/ have questions may send their questions in advance mentioning their name demat account number/folio number, email id, mobile number at [hilinvestors@adityabirla.com](mailto:hilinvestors@adityabirla.com) during the period Tuesday, 16<sup>th</sup> August, 2022 at 09:00 A.M. to Thursday, 18<sup>th</sup> August, 2022 at 05:00 P.M. The same will be replied by the company.
34. Those shareholders who have registered themselves as a speaker will only be allowed to express their views/ ask questions during the meeting.
35. Members are requested to make all correspondence in connection with the shares held by them by addressing letters directly to the Company quoting their Folio number or their Client ID number with DP ID number, as the case may be.

#### **PROCEDURE FOR CASTING VOTE ELECTRONICALLY USING NSDL E-VOTING SYSTEM AND JOINING THE AGM THROUGH VC/OAVM:**

##### **How do I vote electronically using NSDL e-Voting system?**

The way to vote electronically on NSDL e-Voting system consists of "Two Steps" which are mentioned below:

##### **Step 1: Access to NSDL e-Voting system**

##### **A) Login method for e-Voting and joining virtual meeting for Individual shareholders holding securities in demat mode**

In terms of SEBI circular dated December 9, 2020 on e-Voting facility provided by Listed Companies, Individual shareholders holding securities in demat mode are allowed to vote through their demat account maintained with Depositories and Depository Participants. Shareholders are advised to update their mobile number and email Id in their demat accounts in order to access e-Voting facility.

Login method for Individual shareholders holding securities in demat mode is given below:

Type of shareholders	Login Method
Individual Shareholders holding securities in demat mode with NSDL.	<ol style="list-style-type: none"> <li data-bbox="357 284 1399 560">1. Existing <b>IDeAS</b> user can visit the e-Services website of NSDL Viz <a href="https://eservices.nsdl.com">https://eservices.nsdl.com</a> either on a Personal Computer or on a mobile. On the e-Services home page click on the “<b>Beneficial Owner</b>” icon under “<b>Login</b>” which is available under ‘<b>IDeAS</b>’ section , this will prompt you to enter your existing User ID and Password. After successful authentication, you will be able to see e-Voting services under Value added services. Click on “<b>Access to e-Voting</b>” under e-Voting services and you will be able to see e-Voting page. Click on company name or <b>e-Voting service provider i.e. NSDL</b> and you will be re-directed to e-Voting website of NSDL for casting your vote during the remote e-Voting period or joining virtual meeting &amp; voting during the meeting.</li> <li data-bbox="357 560 1399 667">2. If you are not registered for IDeAS e-Services, option to register is available at <a href="https://eservices.nsdl.com">https://eservices.nsdl.com</a>. Select “<b>Register Online for IDeAS Portal</b>” or click at <a href="https://eservices.nsdl.com/SecureWeb/IdeasDirectReg.jsp">https://eservices.nsdl.com/SecureWeb/IdeasDirectReg.jsp</a></li> <li data-bbox="357 667 1399 983">3. Visit the e-Voting website of NSDL. Open web browser by typing the following URL: <a href="https://www.evoting.nsdl.com/">https://www.evoting.nsdl.com/</a> either on a Personal Computer or on a mobile. Once the home page of e-Voting system is launched, click on the icon “Login” which is available under ‘Shareholder/Member’ section. A new screen will open. You will have to enter your User ID (i.e. your sixteen digit demat account number hold with NSDL), Password/OTP and a Verification Code as shown on the screen. After successful authentication, you will be redirected to NSDL Depository site wherein you can see e-Voting page. Click on company name or <b>e-Voting service provider i.e. NSDL</b> and you will be redirected to e-Voting website of NSDL for casting your vote during the remote e-Voting period or joining virtual meeting &amp; voting during the meeting.</li> <li data-bbox="357 983 1399 1322">4. Shareholders/Members can also download NSDL Mobile App “<b>NSDL Speede</b>” facility by scanning the QR code mentioned below for seamless voting experience. <div data-bbox="644 1064 1077 1322" style="text-align: center;">  <p>The image shows a promotional banner for the NSDL Mobile App. At the top, it says "NSDL Mobile App is available on" in blue. Below this, there are two logos: the Apple App Store logo and the Google Play logo. Underneath each logo is a QR code for scanning to download the app.</p> </div> </li> </ol>
Individual Shareholders holding securities in demat mode with CDSL	<ol style="list-style-type: none"> <li data-bbox="357 1342 1399 1479">1. Existing users who have opted for Easi / Easiest, they can login through their user id and password. Option will be made available to reach e-Voting page without any further authentication. The URL for users to login to Easi / Easiest are <a href="https://web.cdslindia.com/myeasi/home/login">https://web.cdslindia.com/myeasi/home/login</a> or <a href="http://www.cdslindia.com">www.cdslindia.com</a> and click on New System Myeasi.</li> <li data-bbox="357 1479 1399 1554">2. After successful login of Easi/Easiest the user will be also able to see the E Voting Menu. The Menu will have links of <b>e-Voting service provider i.e. NSDL</b>. Click on <b>NSDL</b> to cast your vote.</li> <li data-bbox="357 1554 1399 1628">3. If the user is not registered for Easi/Easiest, option to register is available at <a href="https://web.cdslindia.com/myeasi/Registration/EasiRegistration">https://web.cdslindia.com/myeasi/Registration/EasiRegistration</a></li> <li data-bbox="357 1628 1399 1800">4. Alternatively, the user can directly access e-Voting page by providing demat Account Number and PAN No. from a link in <a href="http://www.cdslindia.com">www.cdslindia.com</a> home page. The system will authenticate the user by sending OTP on registered Mobile &amp; Email as recorded in the demat Account. After successful authentication, user will be provided links for the respective ESP i.e. <b>NSDL</b> where the e-Voting is in progress.</li> </ol>

Individual Shareholders (holding securities in demat mode) login through their depository participants	You can also login using the login credentials of your demat account through your Depository Participant registered with NSDL/CDSL for e-Voting facility. upon logging in, you will be able to see e-Voting option. Click on e-Voting option, you will be redirected to NSDL/CDSL Depository site after successful authentication, wherein you can see e-Voting feature. Click on company name or e-Voting service provider i.e. NSDL and you will be redirected to e-Voting website of NSDL for casting your vote during the remote e-Voting period or joining virtual meeting & voting during the meeting.
--	--

**Important note:** Members who are unable to retrieve User ID/ Password are advised to use Forget User ID and Forget Password option available at abovementioned website.

**Helpdesk for Individual Shareholders holding securities in demat mode for any technical issues related to login through Depository i.e. NSDL and CDSL.**

Login type	Helpdesk details
Individual Shareholders holding securities in demat mode with NSDL	Members facing any technical issue in login can contact NSDL helpdesk by sending a request at <a href="mailto:evoting@nsdl.co.in">evoting@nsdl.co.in</a> or call at toll free no.: 1800 1020 990 and 1800 22 44 30
Individual Shareholders holding securities in demat mode with CDSL	Members facing any technical issue in login can contact CDSL helpdesk by sending a request at <a href="mailto:helpdesk.evoting@cDSLindia.com">helpdesk.evoting@cDSLindia.com</a> or contact at 022- 23058738 or 022-23058542-43

**B) Login Method for e-Voting and joining virtual meeting for shareholders other than Individual shareholders holding securities in demat mode and shareholders holding securities in physical mode. How to Log-in to NSDL e-Voting website?**

1. Visit the e-Voting website of NSDL. Open web browser by typing the following URL: <https://www.evoting.nsdl.com/> either on a Personal Computer or on a mobile.
2. Once the home page of e-Voting system is launched, click on the icon "Login" which is available under 'Shareholder/ Member' section.
3. A new screen will open. You will have to enter your User ID, your Password/OTP and a Verification Code as shown on the screen.

Alternatively, if you are registered for NSDL eservices i.e. IDEAS, you can log-in at <https://eservices.nsdl.com/> with your existing IDEAS login. Once you log-in to NSDL eservices after using your log-in credentials, click on e-Voting and you can proceed to Step 2 i.e. Cast your vote electronically.

4. Your User ID details are given below :

Manner of holding shares i.e. Demat (NSDL or CDSL) or Physical	Your User ID is:
a) For Members who hold shares in demat account with NSDL.	8 Character DP ID followed by 8 Digit Client ID For example if your DP ID is IN300*** and Client ID is 12***** then your user ID is IN300***12*****.
b) For Members who hold shares in demat account with CDSL.	16 Digit Beneficiary ID For example if your Beneficiary ID is 12***** then your user ID is 12*****
c) For Members holding shares in Physical Form.	EVEN Number followed by Folio Number registered with the company For example if folio number is 001*** and EVEN is 101456 then user ID is 101456001***

5. Password details for shareholders other than Individual shareholders are given below:
  - a) If you are already registered for e-Voting, then you can use your existing password to login and cast your vote.
  - b) If you are using NSDL e-Voting system for the first time, you will need to retrieve the 'initial password' which was communicated to you. Once you retrieve your 'initial password', you need to enter the 'initial password' and the system will force you to change your password.
  - c) How to retrieve your 'initial password'?
    - (i) If your email ID is registered in your demat account or with the company, your 'initial password' is communicated to you on your email ID. Trace the email sent to you from NSDL from your mailbox. Open the email and open the attachment i.e. a .pdf file. Open the .pdf file. The password to open the .pdf file is your 8 digit client ID for NSDL account, last 8 digits of client ID for CDSL account or folio number for shares held in physical form. The .pdf file contains your 'User ID' and your 'initial password'.
    - (ii) If your email ID is not registered, please follow steps mentioned below in **process for those shareholders whose email ids are not registered.**
6. If you are unable to retrieve or have not received the "Initial password" or have forgotten your password:
  - a) Click on "**Forgot User Details/Password?**" (If you are holding shares in your demat account with NSDL or CDSL) option available on [www.evoting.nsdl.com](http://www.evoting.nsdl.com).
  - b) **Physical User Reset Password?** (If you are holding shares in physical mode) option available on [www.evoting.nsdl.com](http://www.evoting.nsdl.com).
  - c) If you are still unable to get the password by aforesaid two options, you can send a request at [evoting@nsdl.co.in](mailto:evoting@nsdl.co.in) mentioning your demat account number/folio number, your PAN, your name and your registered address etc.
  - d) Members can also use the OTP (One Time Password) based login for casting the votes on the e-Voting system of NSDL.
7. After entering your password, tick on Agree to "Terms and Conditions" by selecting on the check box.
8. Now, you will have to click on "Login" button.
9. After you click on the "Login" button, Home page of e-Voting will open.

## **Step 2: Cast your vote electronically and join AGM on NSDL e-Voting system.**

### **How to cast your vote electronically and join AGM on NSDL e-Voting system?**

1. After successful login at Step 1, you will be able to see all the companies "EVEN" in which you are holding shares and whose voting cycle and General Meeting is in active status.
2. Select "EVEN" of company for which you wish to cast your vote during the remote e-Voting period and casting your vote during the General Meeting. For joining virtual meeting, you need to click on "VC/OAVM" link placed under "Join Meeting".
3. Now you are ready for e-Voting as the Voting page opens.
4. Cast your vote by selecting appropriate options i.e. assent or dissent, verify/modify the number of shares for which you wish to cast your vote and click on "Submit" and also "Confirm" when prompted.
5. Upon confirmation, the message "Vote cast successfully" will be displayed.
6. You can also take the printout of the votes cast by you by clicking on the print option on the confirmation page.
7. Once you confirm your vote on the resolution, you will not be allowed to modify your vote.



### General Guidelines for shareholders

1. Institutional shareholders (i.e. other than individuals, HUF, NRI etc.) are required to send scanned copy (PDF/JPG Format) of the relevant Board Resolution/ Authority letter etc. with attested specimen signature of the duly authorized signatory(ies) who are authorized to vote, to the Scrutinizer by e-mail to [narasimhan.b8@gmail.com](mailto:narasimhan.b8@gmail.com) with a copy marked to [evoting@nsdl.co.in](mailto:evoting@nsdl.co.in). Institutional shareholders (i.e. other than individuals, HUF, NRI etc.) can also upload their Board Resolution / Power of Attorney / Authority Letter etc. by clicking on "**Upload Board Resolution / Authority Letter**" displayed under "**e-Voting**" tab in their login.
2. It is strongly recommended not to share your password with any other person and take utmost care to keep your password confidential. Login to the e-voting website will be disabled upon five unsuccessful attempts to key in the correct password. In such an event, you will need to go through the "Forgot User Details/Password?" or "Physical User Reset Password?" option available on [www.evoting.nsdl.com](http://www.evoting.nsdl.com) to reset the password.
3. In case of any queries, you may refer the Frequently Asked Questions (FAQs) for Shareholders and e-voting user manual for Shareholders available at the download section of [www.evoting.nsdl.com](http://www.evoting.nsdl.com) or call on toll free no.: 1800 1020 990 and 1800 22 44 30 or send a request to Ms. Soni Singh at [evoting@nsdl.co.in](mailto:evoting@nsdl.co.in)

### **Process for those shareholders whose email ids are not registered with the depositories for procuring User id and password and registration of email ids for e-voting for the resolutions set out in this notice:**

1. In case shares are held in physical mode please provide Folio No., Name of shareholder, scanned copy of the share certificate (front and back), PAN (self attested scanned copy of PAN card), AADHAR (self attested scanned copy of Aadhar Card) by email to [hilinvestors@adityabirla.com](mailto:hilinvestors@adityabirla.com).
2. In case shares are held in demat mode, please provide DPID-CLID (16 digit DPID + CLID or 16 digit beneficiary ID), Name, client master or copy of Consolidated Account statement, PAN (self attested scanned copy of PAN card), AADHAR (self attested scanned copy of Aadhar Card) to [hilinvestors@adityabirla.com](mailto:hilinvestors@adityabirla.com). If you are an Individual shareholders holding securities in demat mode, you are requested to refer to the login method explained at **step 1 (A)** i.e. **Login method for e-Voting and joining virtual meeting for Individual shareholders holding securities in demat mode.**
3. Alternatively shareholder/members may send a request to [evoting@nsdl.co.in](mailto:evoting@nsdl.co.in) for procuring user id and password for e-voting by providing above mentioned documents.
4. In terms of SEBI circular dated December 9, 2020 on e-Voting facility provided by Listed Companies, Individual shareholders holding securities in demat mode are allowed to vote through their demat account maintained with Depositories and Depository Participants. Shareholders are required to update their mobile number and email ID correctly in their demat account in order to access e-Voting facility.

### **THE INSTRUCTIONS FOR MEMBERS FOR e-VOTING ON THE DAY OF THE AGM ARE AS UNDER:-**

1. The procedure for e-Voting on the day of the AGM is same as the instructions mentioned above for remote e-voting.
2. Only those Members/ shareholders, who will be present in the AGM through VC/OAVM facility and have not casted their vote on the Resolutions through remote e-Voting and are otherwise not barred from doing so, shall be eligible to vote through e-Voting system in the AGM.
3. Members who have voted through Remote e-Voting will be eligible to attend the AGM. However, they will not be eligible to vote at the AGM.
4. The details of the person who may be contacted for any grievances connected with the facility for e-Voting on the day of the AGM shall be the same person mentioned for Remote e-voting.

#### **INSTRUCTIONS FOR MEMBERS FOR ATTENDING THE AGM THROUGH VC/OAVM ARE AS UNDER:**

1. Member will be provided with a facility to attend the AGM through VC/OAVM through the NSDL e-Voting system. Members may access by following the steps mentioned above for **Access to NSDL e-Voting system**. After successful login, you can see link of "VC/OAVM link" placed under "**Join meeting**" menu against company name. You are requested to click on VC/OAVM link placed under Join Meeting menu. The link for VC/OAVM will be available in Shareholder/Member login where the EVEN of Company will be displayed. Please note that the members who do not have the User ID and Password for e-Voting or have forgotten the User ID and Password may retrieve the same by following the remote e-Voting instructions mentioned in the notice to avoid last minute rush.
2. Members are encouraged to join the Meeting through Laptops for better experience.
3. Further Members will be required to allow Camera and use Internet with a good speed to avoid any disturbance during the meeting.
4. Please note that Participants Connecting from Mobile Devices or Tablets or through Laptop connecting via Mobile Hotspot may experience Audio/Video loss due to Fluctuation in their respective network. It is therefore recommended to use Stable Wi-Fi or LAN Connection to mitigate any kind of aforesaid glitches.
5. Shareholders who would like to express their views/have questions may send their questions in advance mentioning their name demat account number/folio number, email id, mobile number at [hilinvestors@adityabirla.com](mailto:hilinvestors@adityabirla.com). The same will be replied by the company suitably.

For ease of participation by Members, provided below are key details regarding the AGM for reference:

Sr. No.	Particulars	Details of access
1.	Link for live webcast of the AGM and for participation through VC / OAVM	<a href="https://www.evoting.nSDL.com/">https://www.evoting.nSDL.com/</a> by using e-voting credentials and clicking on video conference
2.	AGM queries and speaker registration and period of registration	By email to <a href="mailto:hilinvestors@adityabirla.com">hilinvestors@adityabirla.com</a> . Period of registration: Tuesday, 16 <sup>th</sup> August, 2022 at 09:00 A.M. to Thursday, 18 <sup>th</sup> August, 2022 at 05:00 P.M.
3.	Link for remote e-voting	<a href="https://www.evoting.nSDL.com">https://www.evoting.nSDL.com</a>
4.	Username and password for VC	Members may attend the AGM through VC by accessing the link <a href="https://www.evoting.nSDL.com">https://www.evoting.nSDL.com</a> by using the remote e-voting credentials. Please refer the instructions provided in the Notice.
5.	Helpline number for VC participation and e-voting	Contact NSDL at 1800-1020-990 or write them on <a href="mailto:evoting@nSDL.co.in">evoting@nSDL.co.in</a> or visit website: <a href="http://www.evoting.nSDL.com">www.evoting.nSDL.com</a>
6.	Cut-off date for e-voting	Tuesday, 16 <sup>th</sup> August, 2022
7.	Time period for remote e-voting	From 20 <sup>th</sup> August, 2022 - 09.00 A.M. to 22 <sup>nd</sup> August, 2022 - 05.00 P.M.
8.	Book closure dates	Tuesday, 16 <sup>th</sup> August 2022 to Monday, 22 <sup>nd</sup> August, 2022 (both days inclusive)
9.	Last date for publishing results of the e-voting	Wednesday, 25 <sup>th</sup> August, 2022
10.	Registrar and Transfer Agent - contact details	Hindalco Industries Limited, In- House Investor Service Department Ahura Centre, B Wing, 1 <sup>st</sup> Floor, Mahakali Caves Road, Andheri (East), Mumbai-400 093. Email id: <a href="mailto:hilinvestors@adityabirla.com">hilinvestors@adityabirla.com</a>
11.	Hindalco Industries Limited– contact details	<b>Registered Office Address:</b> Ahura Centre, B wing, 1 <sup>st</sup> Floor, Mahakali Caves Road, Andheri (East). Mumbai- 400 093. Email id: <a href="mailto:hilinvestors@adityabirla.com">hilinvestors@adityabirla.com</a>

**NEW AGE.  
NEW PARADIGMS.  
NEW IDEAS.**



INTEGRATED ANNUAL REPORT

**2021-22**

HINDALCO INDUSTRIES LIMITED

**BIG IN YOUR LIFE**



Mr. Aditya Vikram Birla

**We live by his values**

**Integrity, Commitment, Passion, Seamlessness and Speed**



## Message from the Chairman



Over the years, corporations have tried to find a balance between efficiency and resilience, with successive decades of growth having swung the pendulum in the direction of efficiency. The events of the last two years have again taught us all the virtues of reserves and resilience.

This era of disruption also presents a unique opportunity for renewal. The exigencies of this disruption have pushed the boundaries of innovation. A world where traditional rules didn't apply, freed thinking from its conventional shackles. And we are clearly staring at a **new age**, with **new paradigms** and **new ideas**.

### **Global Economy: The Storm Before the Calm?**

The Global economy recovered from the pandemic shock in 2022 on the back of supportive fiscal and monetary policies and mass vaccination programmes. However, at the end of FY2021-22, the war in Ukraine and the subsequent economic sanctions on Russia posed a large shock. It disrupted energy markets and supply chains and added to the already evolving inflationary pressures and concerns over consumer demand. Consequently, growth forecasts have been slashed. The International Monetary Fund (IMF) now expects the world economy to grow by 3.6% in CY2021-22, which is 0.8 percentage points lower than its pre-war projections.

Many economies have experienced a sharp surge in inflation recently, particularly in food and fuel prices, taking their inflation rates to multi-decade highs. Central banks have been forced to respond to surging prices with aggressive rate hikes. The pace of monetary tightening is turning out to be quite swift as central bankers attempt to catch up with the rising inflation from their ultra-accommodative stance during the pandemic.

### **Dear Shareholders,**

For many years, we have been talking about increasing volatility and unpredictability. The events of the last 24 months have heralded a new era of uncertainty where both the amplitude and frequency of shifts have vastly exceeded anything we have seen in recent decades.

The unprecedented pandemic was followed by supply chain whiplash, and further disruption was brought on by the Russia-Ukraine war. We are now staring at the spectre of a high-interest rate and high-inflation regime globally.



# Message from the Chairman

Across businesses and markets, our evolution is a story of continuous renewal and regeneration, as we aggressively invested in growth and created long-term value for all stakeholders.

As the stance of monetary policy shifts, there is greater turbulence in currency markets. The dollar has strengthened, while emerging economies have witnessed downward pressure on their currencies. At the same time, energy and commodity markets have witnessed heightened volatility. Global supply chain disruptions due to pandemic-induced lockdowns have been replaced by new disruptions caused by the war in Ukraine and the economic sanctions.

While the global economic backdrop remains challenging, there are reasons to remain optimistic. First, despite the slowdown, IMF's projection of world GDP growth in CY 2021-22 is still tracking the pre-pandemic average. Second, fiscal support in developed economies remains above the pre-pandemic trend, even if somewhat diluted, versus past years. Third, mega-trends around sustainability, green investments, digitisation, and disintermediation remain well-entrenched and will support growth and productivity enhancement in the medium term.

Thus, while businesses will need to remain on guard regarding financial market volatility and cost pressures this year, one could expect the medium-term growth recovery to remain on track.

## India: An Engine of Global Growth

The Indian economy has not remained unscathed by these global developments. Partly on account of the elevated commodity prices in global markets, India's inflation has pushed higher than the target of the Reserve Bank of India (RBI). To control inflationary risks, and reduce the pressure on the rupee, RBI has been selling reserves and unwinding the extraordinary liquidity support provided by it during the pandemic.

On the positive side, economic activity in India has witnessed a sharp recovery to pre-pandemic levels on the back of a rapid and widespread rollout of the vaccination programme. A strong digital ecosystem, fiscal and monetary policy and various government schemes helped small and medium enterprises and the worst affected sections of the population to survive while reviving demand and bringing the economy back on track.

Even as the global headwinds are being felt, India's growth recovery is progressing well, and most estimates peg economic growth during FY 2022-23 around the 7% range. India, therefore, is poised to be the fastest-growing major economy in the world and an engine of global growth.

India's exports are exhibiting a strong buoyancy, and economic sentiment has been supported by a robust pipeline of infrastructure projects as well as the government's pragmatic policies, such as the production-linked incentives schemes. Many industries have witnessed fresh project investment announcements. Foreign direct investment flows have remained strong. The burden of non-performing assets in the banking sector seems to have peaked out and is easing. Dynamism in India's digital ecosystem, diversification of global supply chains, away from China, and the greater emphasis of investors on sustainable finance offer new opportunities for India.

The trends lend confidence to a robust economic narrative for India in the medium term, which augurs well for the corporate sector as well.

## Aditya Birla Group: Dynamism and Resilience at Play

The Aditya Birla Group's pace of activity, range of businesses, and depth of global presence provides a useful compass to navigate this age of disruption. Against the backdrop of our long history as a Group, dynamism leaps out as a common theme. Over the years, we have witnessed multiple business cycles.

Across businesses and markets, our evolution is a story of continuous renewal and regeneration, as we aggressively invested in growth and created long-term value for all stakeholders. This institutional dynamism and resilience helped us navigate an unprecedented business environment in FY2021-22.

The pandemic inordinately impacted the future of work, workforce, and workplace. We have moved with the new work ethic by focusing on a holistic employee experience that puts equal emphasis on growth, engagement, and wellbeing.

Our employees value and appreciate the One ABG culture, which is profoundly embedded across the organisation. This culture gives the ultimate competitive edge in a world where business models are easily upended.

It has been a matter of great pride for us that our employee engagement has continued to be strong despite the stresses of the pandemic. 87% of our employees stated in a survey that they have a colleague/friend at work to lean on during difficult times. 96% of our employees experienced considerate behaviour from their managers during this period.

## We Are Only as Strong as Our People

The Group's continued focus and investment in its People Processes in good times have helped us build and sustain a robust and agile workforce that is able to be nimble and responsive at all times. When corporates across the world are facing a rather unusual phenomenon - The Great Resignation - our employee survey score for Intent to stay remained strong. It is higher than the Global High Performing organisations and almost similar to pre-COVID levels. This strong affinity is a testimony to our relentless commitment to delivering a world of opportunities with care to our employees.

Internal employee movements of over 5,000 (within the businesses) were up 18% from the average of the last two fiscals. We also focussed on bringing in young talent, with 73% of new hires being under 35 years of age. Last year, over 9,000 new employees joined the Group refreshing our competence base.

Building an aspirational workplace for a diverse workforce was identified as one of the important aspects of our new HR strategy. Enhancing the diversity of our Group is a journey, and it is getting strengthened with targeted efforts over time. Our commitment to gender diversity is evident through the appointment of 7 women to senior leadership roles. 21% of all new hires were women, and we had 102 women engineering graduates join us at plant locations.

We have always looked for opportunities to showcase the power of our women leadership. This year, our cement business, UltraTech launched India's first 'all-women' operated Ready-Mix Concrete (RMC) manufacturing plant at Bhugaon, Pune. Our list of firsts includes Aditya Birla AMC's all-women Mutual Fund branch in Bhilai, Chhattisgarh and Aditya Birla Fashion and Retail's Madura manufacturing plants in the South zone, which has 85% women employees.

Internal employee movements of over 5,000 (within the businesses) were up 18% from the average of the last two fiscals. We also focussed on bringing in young talent, with 73% of new hires being under 35 years of age. Last year, over 9,000 new employees joined the Group refreshing our competence base.

Our learning strategy evolved continually to adapt in response to the dynamic external environment. This was achieved by re-designing innovative learning properties and methodologies focussing on building contemporary and contextual skills. We shifted gears across digital, blended, and now hybrid learning, making it easier to shift across modes of learning for different sets of learners. We strategically increased the adoption and penetration of our digital learning platform (Gyanodaya Virtual Campus) to cover 94% of our employees in the management cadre. Leveraging the power of internal and external networks, 500+ high-quality digital content modules were created on various themes and topics across ABG.

The spirit of ABG's resilience and dynamism was displayed at an individual, team and business level. This has been reflected in the business results for FY2021-22.

This year also saw the launch of new businesses, units, capacity, products, and brands. This happened seamlessly, presenting a unique human story of innovation and grit; and bringing alive our Group values of commitment and passion. We have together navigated an unprecedented period of disruption and emerged stronger and sharper—demonstrating that care, empathy, and results are mutually compatible. Especially so in periods of turmoil.

## Your Company's Performance

Your Company delivered its exceptional financial and operational performance consolidated performance in FY2021-22, backed by favourable macros, better cost control and operational efficiencies. This record performance was delivered despite challenges like the ongoing pandemic, a steep inflation in input costs, volatility in commodity prices, and global supply chain disruptions due to the geopolitical situations.

Despite these headwinds, your Company registered an all-time high consolidated business EBITDA of ₹30,056 Crore on a turnover of ₹1,95,059 Crore in FY2021-22. Your Company's aluminium business in India and Novelis continued to deliver a record financial performance, despite tough market conditions caused by inflationary challenges and rising input costs.

The major enablers were improved macros, thrust on operational efficiencies and improved performance of India downstream business and a strong revival of demand. All the plants operated at their designed capacities during the year in both Aluminium and Copper. Hindalco's consolidated EBITDA continued to be delinked from the volatility of the global aluminium prices taking together the EBITDA of Novelis, Copper and India Aluminium downstream VAP.



## Message from the Chairman

Your Company retained its position of being World's Most Sustainable Aluminium Company (as per S&P Dow Jones Sustainability Indices Corporate Sustainability Assessment 2020 & 2021) and the only aluminium company in the DJSI World Index 2021.

As a step towards the downstream expansion plans in India, your Company acquired Hydro's aluminium extrusions business in Kuppam, Andhra Pradesh, aligned with its strategy to increase downstream capacity to meet the growing market demand, further expand product portfolio and increase revenue from value-added products. The Kuppam plant will also serve as an archetype for Hindalco's upcoming state-of-the-art extrusions plant in Silvassa in Western India. Your Company intends to build a larger value-added product portfolio over the next few years.

Your Company's Copper business, delivered a strong performance across all fronts amid challenges posed by the pandemic, rise in LME, and supply chain disruptions. In FY2021-22, your Company acquired Polycab's CCR unit, Ryker (now Asoj) having a capacity of 2,25,000 MT of copper rods in Gujarat. Post this acquisition, Birla Copper now ranks among the world's Top-3 copper rod players outside of China. The cathode production was 359 kt in FY2021-22 versus 262 kt in the prior year. The Continuous Cast Rod production was higher at 259 kt in FY2021-22, versus 235 kt in the previous year.

Novelis reported yet another remarkable performance this year with a record shipment of 3,858 kt, adjusted EBITDA of \$2.045 Billion. The adjusted EBITDA/tonne of \$530 was also the highest ever. Novelis continues to improve its product mix with the share of beverage can sheet at 58%, Automotive body sheets at 17%, Specialties at 23% and Aero at 2% in FY2021-22. Novelis reported the share of recycled contents at 57% in FY2021-22, and continues to be world's largest recycler. Your Company continues to focus on strengthening the balance sheet with the consolidated Net Debt-to-EBITDA at 1.36 times at the end of the FY2021-22 from the peak of 3.83 times at the end of June 2020 post the closure of the Aleris acquisition and 2.59 times at the end of March 2021.

On the back of this strong and exceptional performance and with a strong balance sheet, your Company announced a total capital expenditure of nearly \$8 Billion to be spent over the next five years in India and Novelis together. All these investments are directed towards your Company's focus on transformational organic growth through expansion in the downstream businesses in Novelis and India. This investment includes Novelis' identified more than \$4.5 Billion worth of potential organic opportunities to serve the growing demand for sustainable aluminium products. In the India business, your Company has announced a capex investment of around \$3-3.3 Billion that shall be allocated to high-growth downstream projects in the growing segments of EVs, E-Mobility, Packaging, Batteries, Building & Construction, and Consumer Durables.

During FY2021-22, your Company retained its position of being World's Most Sustainable Aluminium Company (as per S&P Dow Jones Sustainability Indices Corporate Sustainability Assessment 2020 & 2021) and the only aluminium company in the DJSI World Index 2021. In addition to this, your Company also achieved the prestigious

Gold Class Distinction in the 'S&P Global Sustainability Yearbook' of 2022. This sustainability-led approach to business has enabled your Company to strengthen its balance sheet and set global benchmarks on sustainable business practises. These affirmations inspire your Company to continue to walk the path of sustainability.

### Conclusion

The forces of change engulfing the world are creating a whole new set of exciting possibilities and unbelievable opportunities. Many that didn't even exist yesterday. We are uniquely privileged that we are not passive recipients of changing circumstances but can actively shape our destiny. And this tomorrow is for us to discover and build.

Across businesses, we are at the cusp of a transformational growth cycle. As a business house, we have always made investment decisions based on long-term fundamental drivers like market opportunity, demography, technology, etc. Our strong leadership position across key businesses has come on the back of bold but calibrated long-term bets. Given the inherent strengths of your Company, we are again at a moment where we are uniquely positioned to invest for long-term growth and explore new paradigms. An exciting journey beckons.



**Kumar Mangalam Birla**  
Chairman

# Aditya Birla Group (ABG), a global conglomerate with a turnover of \$60 Billion, is in the league of Fortune 500 companies.

Headquartered in India, the Group has a diversified business portfolio and presence across 14 industry sectors, employing more than 1,40,000 employees belonging to 100 nationalities. It has achieved global and national market leadership in several sectors like metals, pulp and fiber, chemicals, textiles, carbon black, cement, financial services, and fashion retail.

All the Group companies are driven by five core values – Integrity, Commitment, Passion, Seamlessness and Speed. ABG believes in following

a sustainable business model with responsible stewardship, stakeholder engagement and future proofing as its three pillars.

ABG has now embarked on sustainability journey 2.0 with a focus on mainstreaming ESG. Our sustainability journey follows a four-dimensional approach which considers industry, sectoral and operational uniqueness, geographies of operation, value chain approach to include key stakeholder expectations, and short- and long-term time horizons.

## Aditya Birla Group Presence



For more details visit:

[www.adityabirla.com](http://www.adityabirla.com)

## CONTENTS

### Corporate Overview

- 07 About the Report
- 09 New Age. New Paradigms. New Ideas.
- 10 Our Businesses at a Glance
- 14 Our Global Footprint
- 16 Leadership Team
- 18 Board of Directors
- 20 ESG Highlights
- 22 Assimilating Industry 4.0
- 24 Digitalisation at Hindalco
- 26 Message from the Managing Director

### Strategic Overview

- 30 Our Business Model
- 32 Our Strategic Priorities
- 34 Building Resilience
- 40 Stakeholder Engagement
- 44 Materiality Assessment

### Our Capitals

- 46 Financial Capital
- 54 Manufactured Capital
- 68 Human Capital
- 92 Intellectual Capital
- 100 Natural Capital
- 130 Social and Relationship Capital

### Statutory Reports

- 164 Management Discussion & Analysis
- 182 Financial Highlights
- 186 Directors' Report
- 225 Social Report
- 230 Business Responsibility and Sustainability Report
- 246 Corporate Governance Report
- 262 Shareholder Information

### Financial Statements

- 274 Consolidated Financial Statements
- 443 Standalone Financial Statements
- 582 Independent Assurance Statement on Integrated Report



## About the Report

We are proud to present our second Integrated Annual Report showcasing our efforts to create global sustainability benchmarks. The report is based on the Value Reporting Foundation's Integrated Reporting Framework. The Value Reporting Foundation is a global non-profit organisation comprising the International Integrated Reporting Council (IIRC) and Sustainability Accounting Standards Board (SASB).

This report covers the disclosure of our performance across six key capitals - Financial, Manufactured, Intellectual, Natural, Human, as well as Social and Relationship. Apart from our performance, the report highlights our value creation efforts for our stakeholders, identifies risks, opportunities and mitigation plans in the backdrop of a fast-changing external environment and our long-term strategy.

### Reporting Principle

The non-financial performance has been reported in accordance with the Global Reporting Initiative (GRI) 2021 Standards. The report is also aligned with Business Responsibility and Sustainability Report (BRSR), principles of the United Nations Global Compact (UNGC), Sustainability Accounting Standards Board (SASB) as well as the United Nations Sustainable Development Goals (UN SDGs).

The financial and statutory details disclosed in this report are as per the requirements of the Companies Act, 2013 (including the rules made thereunder); Indian Accounting Standards; the Securities and Exchange Board of India (Listing Obligations and Disclosure Requirements) Regulations, 2015; and the Secretarial Standards issued by the Institute of Company Secretaries of India.

### Reporting Period

The information is reported for the period from 1<sup>st</sup> April, 2021 to 31<sup>st</sup> March, 2022.

### Scope and Boundary

The report covers the financial and non-financial parameters of Hindalco Industries Limited. This includes our India operations of aluminium and copper businesses; along with our wholly owned subsidiary, Novelis Inc.

### Independent Assurance

The standalone and consolidated financial statements contained in the Financial Statement section are audited by independent auditors Price Waterhouse & Co. Chartered Accountants LLP. The non-financial assurance is carried out by Ernst and Young Associates LLP. The assurance is based on International Standard on Assurance Engagements (ISAE) 3000 and AccountAbility 1000 Assurance Standard (AA1000AS). The assurance statement is part of this report.

### Forward-looking Statement

There are few statements in the report that refer to our future operations and performance. The forward-looking statements and the identified risks are necessarily based on projections and trends in the industry and could differ from the actual results. These statements include all the statements other than historical facts, performance highlights, strategy and mitigation plans, and objectives.

### Feedback

We publish our reports annually. The previous **Integrated Annual Report** was published in July 2021, and is available on our website. We value your feedback, which will continue to enable us to disclose relevant information in the most effective and transparent manner. We would be happy to address any queries or suggestions that you may have with respect to our performance or this report. You may write to us at [hilinvestors@adityabirla.com](mailto:hilinvestors@adityabirla.com) or contact us on (+91-22) 6691 7000.





# NEW AGE. NEW PARADIGMS. NEW IDEAS.

Growth propelled through our emphasis on Digital and ESG.

Over the years, Hindalco has built a responsible, resilient and agile business, making great strides in our journey towards a greener, stronger and smarter future. Guided by our strong risk management practices we have responded seamlessly to challenges during the pandemic and thrived in a world rife with the uncertainties.

In FY2021-22, as part of our downstream expansion strategy, we acquired two facilities in India: Asoj, a CCR unit in Gujarat and Kuppam, and a high-end extrusions facility at Andhra Pradesh. Despite strong headwinds, we reported our best ever financial performance in the 2022 fiscal.

This was possible due to our continued focus on sustainable business practices and the relationship of trust we have built with our customers, suppliers and the community at large, over the years. Through this enriching journey, we have prepared ourselves to make the most of the opportunities that the post-pandemic world has presented before us, by embracing new ideas and new paradigms in ESG and digitalisation. We are building on this momentum and advancing from being a manufacturing company to a manufacturing solutions provider, as we embark on the next phase of organic expansion.

Thinking and acting proactively on ESG has become imperative for businesses to grow. We have integrated ESG into our core strategy, risk management and business objectives across functions of the organisation. Through our continued

efforts we have been recognised as the World's Most Sustainable Aluminium Company in the world according to the Dow Jones Sustainability Index (DJSI). Hindalco has also maintained its position as an Industry Leader in 2021 and entered the DJSI World Index.

The rapid development in technology across the world has transformed the fundamentals of creating value. To keep up with the changing times, we have embarked on a journey towards 'Smart Hindalco'. We are turning factories into smart factories with swift deployment of automation. We are supporting our people with the insights of powerful analytics and augmentation. Our collaborations with Industry leaders in the digital space have enabled us to speedily deploy technologies across the value chain providing solutions to complex problems.

Through the lens of the six-capitals, our Integrated Annual Report provides a narrative of our strategic vision, our overall performance and the way we create value for stakeholders and the community at large.



# Our Businesses at a Glance



## Hindalco Industries Limited is the metals flagship company of the Aditya Birla Group.

We are the world's largest aluminium rolling and recycling company. One of Asia's largest producers of primary aluminium (Ex. China), we are also the largest aluminium downstream player in India providing customised solutions in flat rolled products and extruded aluminium solutions.

Novelis, our wholly owned subsidiary, is the world's largest aluminium Flat Rolled Products (FRP) producer and aluminium recycler, recycling over 82 Billion cans annually. Novelis' diversified product portfolio caters to beverage cans,

automotive, aerospace and specialties end markets. Our copper facility in India comprises a world-class copper smelter, downstream facilities and a captive jetty. Hindalco is India's largest copper producer, contributing significantly to India's domestic refined copper requirements.

Our global footprint spans 17 manufacturing units and 21 mining operations in India and 33 units overseas. We aim to advance from being a manufacturing company to one that provides comprehensive manufacturing solutions. In fact, in pursuit of sustainable (and green) growth, our aluminum business is making a step change extending its ambition from being an upstream player to building

a differentiated B2B and B2C business, focussing on materials and value-added products and solutions.

With an ambition to be the world's leading provider of low carbon and sustainable aluminium solutions, we have committed to become carbon neutral by 2050, in addition to other ESG commitments. Guided by our purpose of building a greener, stronger, smarter world, we provide innovative solutions for a sustainable planet. In recognition of our sustainability practices, we were named the world's most sustainable aluminium company in the Dow Jones Sustainability Indices (DJSI) for two consecutive years 2020 and 2021.

### Integrity



Honesty in every action

### Commitment



On the foundation of integrity, doing what it takes to deliver, as promised

### Passion



Missionary zeal arising out of an emotional engagement with work

### Seamlessness



Thinking and working together across functional silos, hierarchy levels, businesses, and geographies

### Speed



Responding to stakeholders with a sense of urgency

# Our Businesses at a Glance

## Products and Markets: Our Diversified Offerings

We are an industry leader operating in mainly three business verticals- aluminium, copper, and chemicals. More details of our assets and offerings can be found in the manufactured capital in later chapters.

### Aluminium

- Primary aluminium
- Aluminium value added
  - Flat Rolled Products (FRP)
  - Extrusions
  - Foils and packaging solutions
- Metallurgical alumina

#### Markets Served

- Beverage packaging
- Automotive and transport
- Aerospace
- Pharmaceuticals and food packaging
- Consumer durables and kitchenware
- Building and construction
- Electricals and electronics
- Industrial applications

### Copper

- Cathodes
- Continuous Cast Rods (CCR)
- Gold and Silver
- By-products
  - Di-Ammonium Phosphate (DAP)
  - Sulphuric acid

#### Markets Served

- Automotive and transport
- Consumer durables
- Electrical equipment including wire and cable
- Railway electrification
- EV and renewables

### Chemicals

- Calcined alumina
- Alumina hydrate

#### Markets Served

- Advanced ceramics and catalysts
- Refractories
- Polishing
- Glass
- Electrical and electronic equipment
- Water treatment (Alum/PAC)
- Fire retardant fillers: cables and composites







# Our Global Footprint

We are primarily involved in the business of aluminium and copper, operating across 10 countries with 50 established units. Our operational footprint across India has been indicated on the map.



1 Aditya Aluminium	●●	13 Hirakud S&P	●●
2 Renukoot	●●●●	14 Asoj	●
3 Alupuram	●	15 Hirakud FRP	●
4 Renusagar	●	16 Baphlimali	●
5 Belagavi	●	17 Mouda	●
6 Utkal Alumina	●●	18 Kathautia	●
7 Belur works	●	19 Muri	●●
8 Samri	●	20 Gare Palma	●
9 Dahej	●●	21 Mahan	●●
10 Netarhat	●	22 Talaja	●
11 HAAL	●	23 Kuppam	●
12 Lohardaga	●		

● CPP ● Refinery ● Smelter ● Extrusion/FRP/Foil ● Bauxite ● Coal ● Copper

## Our Key Associations

We have been associated with several reputed trade and industrial bodies. Some of the associations are mentioned below:

- International Aluminium Institute
- Aluminium Association, U.S.A
- European Aluminium Association
- International Copper Association
- Aluminium Association of India
- Federation of Indian Chambers of Commerce and Industry
- Confederation of Indian Industry
- Automotive Research Association of India
- Indian Electrical and Electronics Manufacturers' Association
- Indian Primary Copper Producers Association
- Federation of Indian Export Organisations

## Novelis' Global Operations

### North America and South America

Novelis Inc.	
1 US	■ ■ ■ ■ ● ● ● ● ▲
2 Canada	■ ■ ■ ●
3 Brazil	■ ● ● ● ● ▲

### Europe and the UK

4 Germany	■ ■ ■ ● ● ● ● ▲
5 UK	● ▲
6 Switzerland	■ ■ ■ ● ● ●
7 Italy	■ ● ● ● ▲

### Asia

8 China	■ ● ● ●
9 South Korea	■ ■ ■ ● ● ● ● ▲

■ R&D/Technology Centre ■ Automotive Finishing ■ Cold Rolling ● Finishing Lines ● Casting ● Hot Rolling ▲ Recycling Facility

Note: The map is not to scale and an artistic representation only.





# Leadership Team



## Left to right standing

### Mr. B. Arunkumar

Head – Aluminium Downstream  
Strategic Projects

### Mr. Rajesh Kumar Gupta

Head-Mining & Minerals

### Mr. V.R. Shankar

Head – Legal

### Mr. Satish Pai

Managing Director

### Mr. Nilesh Koul

Head – Downstream Aluminium Business

### Mr. N. Nagesh

Head – Renukoot Cluster

### Mr. Kailash Pandey

Head – Sambalpur Cluster

### Mr. Praveen Kumar Maheshwari

Chief Financial Officer

### Mr. Sanjay R. Agarwal

Head – Strategic Procurement

## Left to right sitting

### Mr. Mazharullah Beig,

Unit Head – Utkal Alumina International Limited

### Mr. Bibhu Mishra

Head – Manufacturing Centre for Excellence

### Mr. Saurabh Khedekar

Head – Chemicals Business

### Mr. Anil Malik

Company Secretary

### Mr. Rohit Pathak

CEO, Copper Business

### Mr. Aniruddha Kulkarni

Chief Strategy Officer

### Mr. Anil Mathew

Head – Policy Advocacy and Chief Risk Officer

### Mr. Samik Basu

Chief Human Resources Officer



# Board of Directors

**Mr. Kumar Mangalam Birla**  
Non-Executive Chairman



NRC

**Mrs. Rajashree Birla**  
Non-Executive Director



CSRC

**Mr. Satish Pai**  
Managing Director



RMC SRC CSRC PIT FC

**Mr. Yazdi Piroj Dandiwala**  
Independent Director



AC NRC CSRC PIT

**Dr. Vikas Balia**  
Independent Director



AC

**Ms. Alka Marezban Bharucha**  
Independent Director



- AC Audit Committee
  - CSRC CSR Committee
  - NRC Nomination and Remuneration Committee
  - RMC Risk Management & ESG Committee
  - SRC Stakeholder Relationship Committee
  - PIT Prevention of Insider Trading (PIT) Regulations Committee
  - FC Finance Committee
- Chairman     ■ Member

**Mr. Praveen Kumar Maheshwari**  
Whole time Director & CFO



RMC

**Mr. Askaran Agarwala**  
Non-Executive Director



SRC CSRC RMC FC

**Mr. Kailash Nath Bhandari**  
Independent Director



AC SRC NRC RMC

**Mr. Sudhir Mital**  
Independent Director



**Mr. Anant Maheshwari**  
Independent Director







# ESG Highlights



## Environment

- Energy and GHG Emissions Management
- Water Management
- Waste and Hazardous Material Management
- Air Emissions
- Compliance Management

- **2.89 Million GJ** energy saved through 170 energy and emissions reduction projects
- **100% increase** in cumulative **Renewable Energy Capacity** to 100MW\*
- **9%** reduction in specific fresh-water consumption for aluminium operations (baseline FY2018-19)\*
- **86%** waste recycled and reused; **6%** (basis points) increase compared to FY2020-21
- **18%** reduction in specific GHG emissions for aluminium operations (baseline FY2011-12) \*
- **\$140 Million** allocated for identified green bond projects by Novelis
- **82+ Billion** used beverage cans recycled annually by Novelis
- **57%** recycled content across Novelis portfolio.
- **10%** yoy increase in Greenbelt **4.53 Lakh** trees planted in FY2021-22\*
- **GreenPro Certification /Eco Label** received for Eternia products and Everlast
- **ASI certification** awarded to Mouda plant in India, in addition to 14 plants at Novelis already ASI certified



## Social

- Occupational Health & Safety
- Employee well-being
- Community Relations
- Security and Human Rights

- **₹87.6 Crore** investment on community development projects
- **Novelis Neighbor-** global programme for community development
- **1.26+ Million** beneficiaries through our community development programmes\*
- **23,212 Self Help Group (SHG) members** supported with financial literacy and conceptual training\*
- **367 students** received scholarships\*
- **3,379 people** received disaster relief support\*
- **64%** Net Promoter Score (Hindalco extrusion) \*
- **₹1,48,236 Crore** Procurement spend
- **7.22%** women in total workforce; 30%+ women among campus hire
- **3.5 Million** hours of training
- **39%** reduction in **LTIFR** over last financial year\*
- **85% VIBES** employee survey score (employee engagement index) \*
- **Great Place to Work™** certified and recognised as GPTW's Best employers among Nation builders\*



## Governance

- Ethics and Integrity
- Economic Performance
- R&D Innovation and Technology
- Compliance Management

- **Highest ever** consolidated revenues at **₹1,95,059 Crore** with **47%** yoy increase
- **₹716 Crore** spent on R&D
- **40** new products developed
- **Acquired two** downstream facilities in India-Asoj (Cu) and Kuppam (Al)
- All employees covered under the **POSH training** programme
- One ERP '**Ekaayan**' phase-wise rollout

\*The details provided are for Hindalco India operations.



# Assimilating Industry 4.0

We intend to LEAD industry by digitally transforming business processes, thereby creating an accelerated pathway for growth.

## Unlocking Value with Digital Transformation

We are accelerating digital innovation by leveraging partnerships within Aditya Birla Group and encouraging a digital culture across the organisation. Our focus has been on improving efficiency through technological upgrades, deploying analytical solutions to augment human intelligence and nurturing workforce with required skills to lead the digital era.

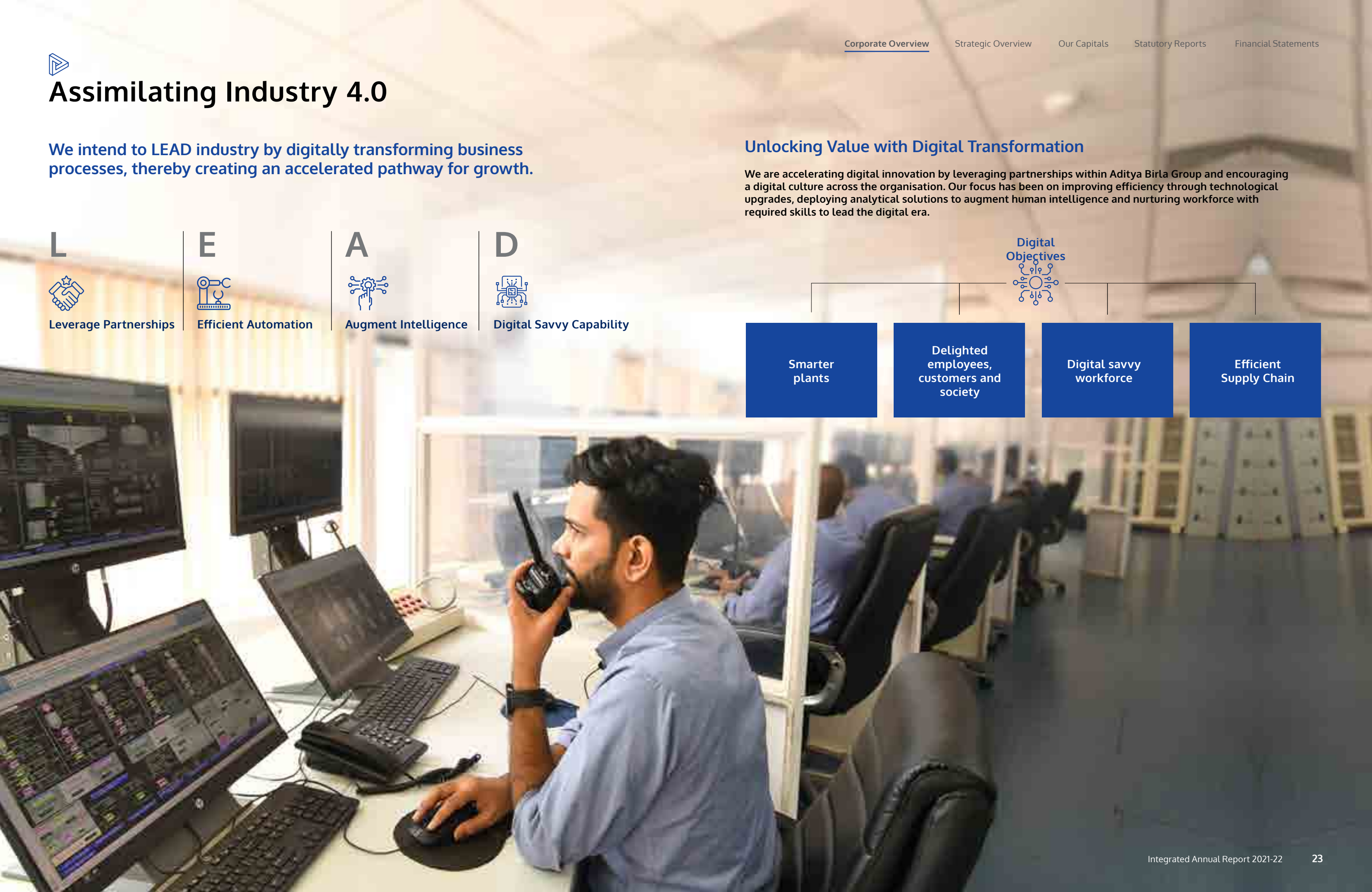
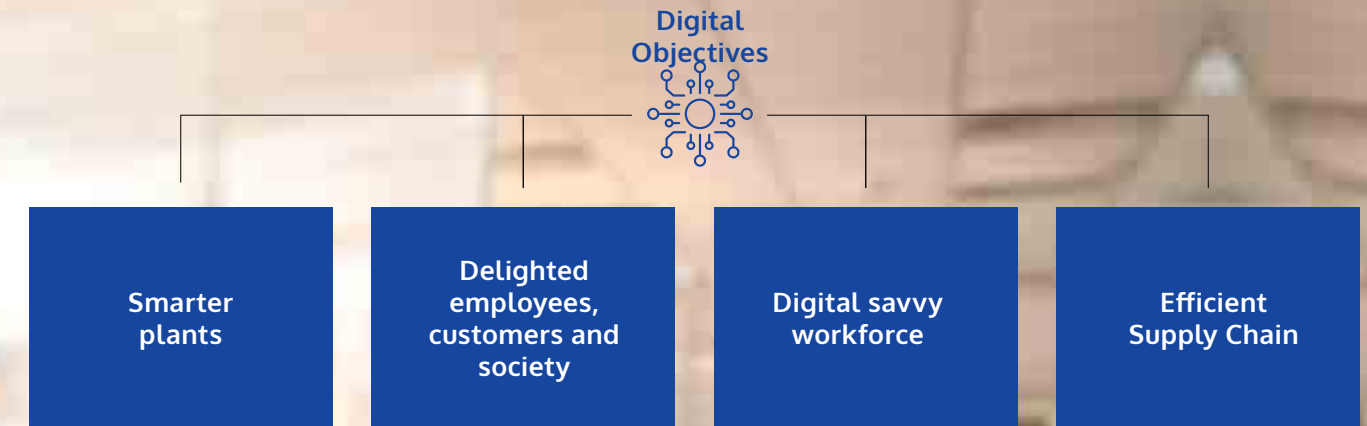
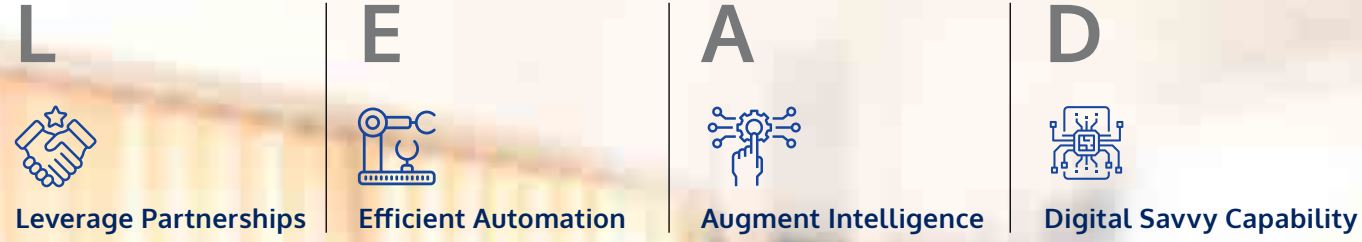





# Digitalisation at Hindalco

## Overall Impact ₹75+ Crore estimated



### DIGITAL INITIATIVES

70+ across value chain



### SMART FACTORY

Driving downstream manufacturing processes through Industrial IoT



### LOGISTICS

End-to-end digitisation at 7 locations using AI platform, Logistics Insights Tower



### ASSET RELIABILITY

Predictive Asset Maintenance at 5 locations for 200+ Assets



### PRODUCTIVITY

RPA and Drones eliminating repetitive activities resulting in 1,000's of hours saved



### PROCUREMENT

Machine Learning based Price Forecasting Models for market shocks



### YIELD & QUALITY

Multiple Machine Learning models and Digital Twin solutions to improve core metrics by up to 1%



### BASIC INFRA

L2 integration, Historian systems etc. to ensure Basic infra at all locations



### OPERATIONS

Rapid deployment of AR during early days of COVID in response to travel restrictions resulting in seamless operations



### SAFETY

Integrated Digital Safety solution through VEDA, Confined Space monitoring and sensors



### CAPABILITY

Reached 2,000+ employees through the DISHA programme and created 175+ Citizen Data Scientists





# Message from the Managing Director

## Sustainability on a global scale

### Dear Stakeholders,

In a globalised marketplace, the industry is increasingly prone to extreme disruptions. In recent times, we have already witnessed the volatility associated with global pandemics, climate events and war. At Hindalco, and the Aditya Birla Group at large, the organisational ethos is built on resilience and willingness to take on all challenges. There is another credo equally at play – our ability to welcome change. To anticipate the rising of a new age, replete with new ideas. To embrace new paradigms and the opportunities that arise. That is the essence of sustain-ability at Hindalco.



Through the years and despite the buffets of market volatility, our operational focus has consistently been on smart and strategic growth, shaped by the shift towards digital technologies and driven by our ESG commitments. Our efforts to stay future ready has allowed us to reach and retain the position of World's Most Sustainable Aluminium Company (as per S&P Dow Jones Sustainability Indices Corporate Sustainability Assessment 2020 & 2021). You may be pleased to note that we are the only aluminium company in the DJSI World Index 2021.

Our growth journey has taken us to 10 countries and 4 continents, making Hindalco-Novelis one of the world's largest non-ferrous companies. Novelis is the world's largest rolling products and recycling company in the world. In the past year, Novelis has announced several expansion projects including a \$365 Million highly-advanced automotive recycling centre in Guthrie, North America and a \$375 Million investment to expand its rolling and recycling capabilities in Zhenjiang, China. In India, Hindalco has invested in extending our downstream footprint, thus making us the largest fully integrated aluminum player going from alumina right to value-added and customised products.

Our efforts to stay future ready has allowed us to reach and retain the position of World's Most Sustainable Aluminium Company. You may be pleased to note that we are the only aluminium company in the DJSI World Index 2021.

### Resilience in Action

Hindalco delivered an exceptional financial and operational performance despite it being a tough year. There were several challenges such as the pandemic, a steep inflation in input costs, volatility in commodity prices, and global supply chain disruptions. In the face of these headwinds, Hindalco persevered and delivered record-breaking profitability for the year. Consolidated Net Profit for the year grew four times to ₹13,730 Crore. Consolidated EBITDA was up 59%, at ₹30,056 Crore in FY2021-22. The powerful financial performance has further strengthened the Company's balance sheet. It has significantly reduced consolidated net leverage ratios from 2.59x in FY2020-21 down to 1.36x at the end of FY2021-22.

We achieved notable milestones across all business segments:

#### Novelis

- Novelis' capacity crossed 4 Mn MT reinforcing our position as the world's largest FRP (Flat Rolled Products) producer
- Net sales peaked to an all-time high of \$17.1 Billion
- Net income crossed the \$1 Billion mark

**₹30,056 CR**  
EBITDA

**₹13,730 CR**  
Net Profit

**1.36x**  
Net Leverage ratio

- Operating cash flows touched \$1 Billion This strong financial performance has significantly reduced net leverage ratios from the peak of 3.8x post-Aleris acquisition, down to 2.2x at the end of FY2021-22

#### India Aluminium

All our aluminium plants achieved record production with lowest raw material consumption.

We successfully commissioned the 5,00,000 tonne brownfield alumina facility at Utkal amid the pandemic, ramping it up to rated capacity in less than a week. With our continued focus on operational excellence and cost control, supported by strong macros, Aluminium India business EBITDA touched ₹13,025 Crore, a 139% growth yoy. EBITDA margins at 41% remained one of the highest in the industry. The results were bolstered by an improved performance by our downstream business validating our strategy of building a sustainable business model isolated from metal cycles.



## Message from the Managing Director

We made a bold move last year when we unveiled our vision for sustainability, with strong commitment towards achieving carbon neutrality, water positivity, no net loss on biodiversity and zero waste to landfill by 2050.

We also decided to put interim targets for India operations on specific energy reduction by 25% from FY2012, specific freshwater reduction by 20% from FY2019 per tonne of Aluminium, water positivity in downstream and mining verticals, 300 MW Renewable Energy capacity and Zero liquid discharge across units by 2025. We have done exceptionally well on all fronts this year and our sustainability performance is a testament to that.

We completed the acquisition of Hydro's aluminium extrusions business in Kuppam, Andhra Pradesh. The acquisition is aligned with Hindalco's strategy to increase downstream capacity to meet the growing market demand and increase revenue from value-added products. The Kuppam plant will also serve as an archetype for Hindalco's upcoming state-of-the-art extrusions plant in Silvassa in Western India.

### Copper

Birla Copper delivered a strong performance across all fronts amid challenges posed by the pandemic, rise in LME and global supply chain disruptions. The business achieved its highest ever domestic sales on the back of stable operations and a sharp market focus. EBITDA for the year showed a 60% growth yoy at ₹1,390 Crore.

In FY2021-22, we completed the acquisition of Ryker's 2,25,000 tonne copper rod facility in Gujarat. Birla Copper now ranks among the world's top-3 Copper Rod players outside of China.

We also entered two new segments— i) Cu-Mg Alloy rods for railways, and ii) Inner Groove Tubes for ACs, where we successfully qualified under the PLI scheme to manufacture these in India. With Copper being a key metal in India's accelerating journey towards Electrification, Urbanisation, Renewables and E-Mobility, Birla Copper is on the cusp of a strong growth trajectory.

### Specialty Alumina

The Specialty Alumina business recorded impressive growth in the face of multiple pressures. Specialty Alumina is a very versatile product with applications across various industries

like ceramics, wires and cables, electrical, electronics, refractories (for steel, cement and glass) as well as niche applications like water treatment, solid surfaces, medical and petrochemicals.

In FY2021-22, the business diversified its product offering with multiple new high-tech products for value-added applications in the wire and cables, refractories and abrasives segments. The industry is growing at about 5% globally, and domestically, between 10% to 18% with elevated growth on the higher-end of VAP range. We believe we are well-poised to capitalise on the opportunity with our cutting-edge value-added product range.

### Seeding New Growth

The sound financial performance and strong balance sheet positions Hindalco well to embark on a new wave of growth. We have announced a total capital expenditure of about \$8 Billion over the next five years. Our focus is on driving transformational organic growth by expanding the downstream business in Novelis, and India. Novelis has identified potential investment opportunities of more than \$4.5 Billion to serve the increasing demand for sustainable aluminium products. In the India Business, we have announced a capex of nearly \$ 3 Billion. 70% of our consolidated cash flows will be allocated towards high-growth downstream segments - EVs, Mobility, Packaging, Batteries, B&C, Consumer durables.

### The Greener, Stronger, Smarter Way

We have taken bold bets to achieve our targets of carbon neutrality, water positivity, no net loss on biodiversity and zero waste to landfill by 2050. We have progressed on all fronts:

- We have reduced specific freshwater consumption by 9% and 27% in India Aluminium and

Copper businesses respectively, over the FY2018-19 baseline. This is towards our target of 20% reduction by 2025.

- We have met our current targets of 100 MW renewable capacity, and going ahead, we intend to achieve a renewable capacity of 300 MW by FY2024-25, including 100 MW solar power capacity with hybrid storage.
- Zero waste to landfill is being pursued by all units through external collaborations. Our waste recycling is at 86% this year, up 6 percentage points. We achieved 114% ash utilisation, and near 100% utilisation of red mud at three of our refineries.
- Our goal for No Net Loss on Biodiversity at sites by 2050 is being roadmapped by our partnership with IUCN. We have been implementing biodiversity management plans at five of our sites this year and are adding nine more. The cumulative green belt in FY2021-22 has grown by 10% over the previous year.
- We are leading the nation in Sustainable Mining through our engagement with Xynteo. The seven thematic areas and related KPIs is a unique framework which holds the key to sustainable mining.

Many of our efforts and practices have been recognised globally, but we are not resting on our laurels. ESG is a serious commitment to the future.

### People come First

We respect and uphold the human rights of all stakeholders. Employees are one of our strongest pillars. Many of our people initiatives have borne fruit. Gender diversity is a key focus area for us and we have pushed for greater diversity hiring at the entry level. Consequently, hiring of

women GETs has gone up from 18% in 2018 to 41% in 2022.

Another noteworthy initiative is the Hindalco Technical University – an online open learning platform that offers world-class learning programmes to our engineers, supervisors and workers on the shopfloor. During the pandemic, HTU delivered 289 learning programmes, benefitting over 60% of technical role holders. Our initiatives for various segments of the workforce make for a great employee experience. Our efforts were recognised with the Great Place to Work Certification by Great Place to Work® Institute (India).

Despite our many successes, sadly, two fatalities were recorded last year. On the positive side, Hindalco has surpassed all its previous safety performances. This can be attributed to the implementation of the 'Serious Injuries and Fatality (SIF) prevention programme', a new and unique initiative in Indian manufacturing which standardises contractor safety management processes across Hindalco.

Guided by the Aditya Birla Group's social vision, Hindalco has been engaged in meaningful welfare driven activities to uplift the lives of underprivileged communities. Our CSR initiatives have touched over 1.26 Million lives across India. Our community expenditure for FY2022 stands at ₹55 Crore.

During the waves of COVID, we made considerable efforts to protect employees across ranks as well as our communities. We increased and improved medical infrastructure at our plant hospitals and healthcare centres, set up oxygen lines in remote locations, and broadened medical coverage to include contract workers, 3<sup>rd</sup> party employees and their families. As an organisation,

## 1.26 MN

lives touched through our CSR activities across India

## 289

learning programmes benefiting 60% of technical role holders

## 41%

Of women in GET hires in 2022

we stood strong with our people. I am especially proud of the care shown by our employees to support each other and our communities.

### Anticipating the Future

Our successes as well as the learnings from our failures inspire us to raise the bar every single time. We believe high performance organisations are by nature sustainability-focused and future ready. Hindalco's achievements are due to the collaborative teamwork of our employees and I take this opportunity to thank everyone for their efforts which resulted in the Company's pathbreaking performance in FY2021-22. I also thank all our stakeholders for your unflinching trust and support. I am pleased to share with you the Integrated Report for FY2021-22 and look forward to your sustained trust in us.



**Satish Pai**  
Managing Director

# Our Business Model

Our business model represents the way our business manages resources for long-term value creation. It is a gear that converts inputs into outcomes and outputs and helps us manufacture materials that make the world greener, smarter, and stronger.

It links our business to the strategic priorities. Through our business, we contribute to the Sustainable Development Goals (SDGs) and have linked the capital to the SDGs.

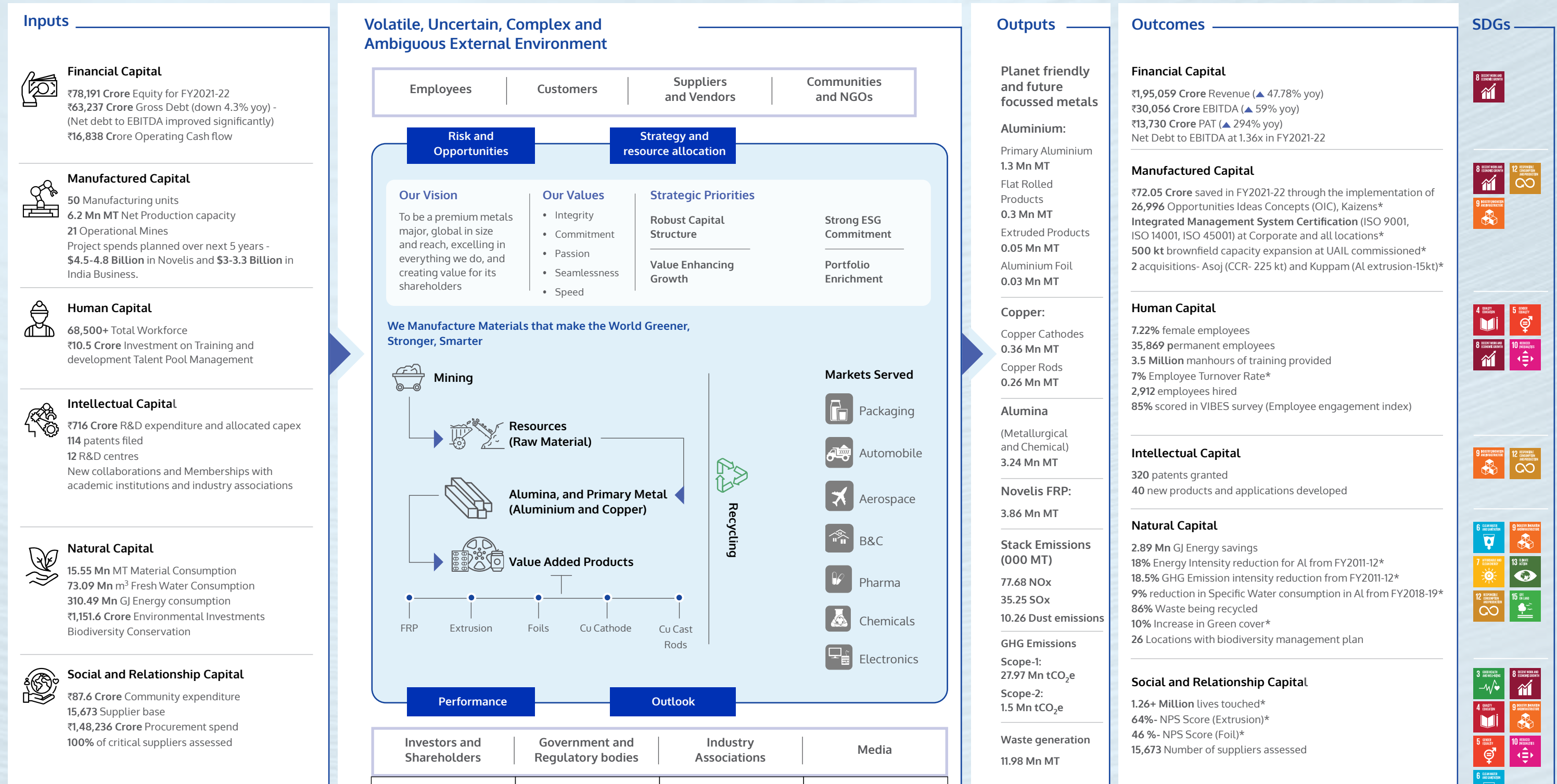

\* The details provided are for Hindalco India operations





# Our Strategic Priorities

At Hindalco, our sharp focus on key strategic priorities has helped us showcase best ever financial and operational performance. In the backdrop of geopolitical uncertainty, shifts in global economic outlook and inflationary pressures, among others, we are embarking on a new journey to achieve new paradigms of growth.

We have defined four strategic priorities in line with our goal of advancing from a manufacturing company to a comprehensive manufacturing solutions provider. With aluminium and copper markets projected to double in the next decade, we plan to leverage on these growth opportunities with the help of strategic priorities to stay ahead of the curve.

The identified strategic priorities are aligned with our growth and ESG commitments. Our approach towards our strategic priorities has led us to achieve positive outcomes during the year.

The rising prominence of ESG related requirements as well as regulations, and increasing awareness related to adoption of greener products has helped us identify key risks and opportunities in these areas.

**SP-1**

## Robust Capital Structure



### Our Approach

- Robust approach to capital allocation framework
- Enhanced focus on shareholder return
- Growth capex directed towards value-added downstream expansion projects

### Outcome

- Deleveraging target achieved well ahead of time
- Stronger balance sheet and enhanced focus on shareholder return
- Achieved a net debt reduction of around 15%

**SP-2**

## Value Enhancing Growth



### Our Approach

- Strong focus on expanding capacities in various business segments and diversifying our portfolio to provide products and solutions
- Expansion of Utkal Alumina to 500 kt ahead of scheduled time
- Expanded our downstream aluminium and copper business with acquisitions of Hydro's SAPA (Kuppam) extrusions facility and Polycab's Ryker copper rods facility (Asoj), both in India

### Outcome

- Higher value creation for our customers.
- Among the top three copper rod manufacturers globally outside of China

**SP-3**

## Strong ESG Commitment



### Our Approach

- Focus on ESG by taking sustainability initiatives across the value chain with clear roadmap for achieving our commitments
- Novelis, the largest aluminium recycler in the world, recycles over 82 Billion cans annually

### Outcome

- Sustainable growth and strong performance
- Retained the title of the most sustainable aluminium company for the second consecutive year by DJSI
- Part of the DJSI World Index (only aluminium company)
- Contribution towards circular economy

**SP-4**

## Portfolio Enrichment



### Our Approach

- Advancing from manufacturing company to manufacturing solution provider
- Greater focus on new and high-value added products

### Outcome

- Higher market share in value-added products segment
- Introduction of new products in segments like aerospace, building and construction, new age mobility etc.





# Building Resilience



In a Volatile, Uncertain, Complex, Ambiguous (VUCA) world, no individual or organisation can predict the 'Unknowns'. But organisations need to prepare for an uncertain and volatile future.

To build this quality of resilience in an organisation, work needs to be done on three fronts:

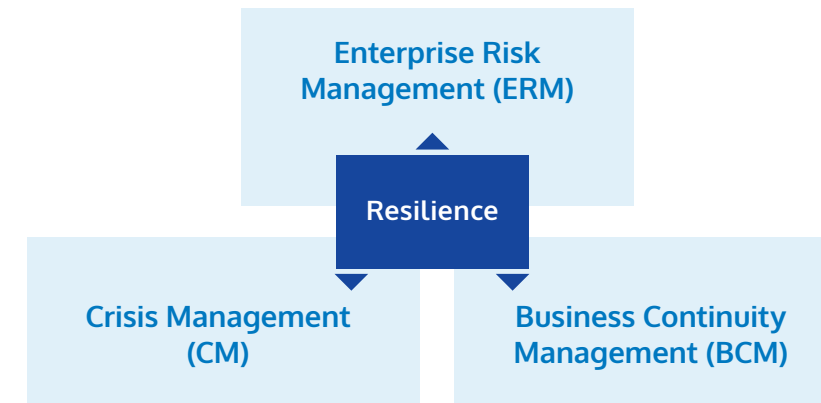

Resilience = Enterprise Risk Management + Crisis Management + Business Continuity Management

ERM tries to REDUCE the impact of the risk before it materialises; CM takes care of the RESPONSE strategy for people/asset safety in times of a crisis event; BCM ensures continuity of operations and RECOVERY from the loss after the event has subsided.

Organisations need to proactively identify risks from all perspectives and ensure efforts to reduce the risk impact through mitigation practices. At Hindalco, we follow a robust ERM process with a set policy, framework and procedure followed uniformly across all plants and corporate functions. Risk identification exercise happens through multiple channels bottoms-up (from units built up to the enterprise), top-down (from enterprise objectives drilled down to individual plants) and outside-in (from external stakeholders, industry challenges, etc.). A risk register is maintained and reviewed at multiple levels in our organisation (from departments to BOD). The action plan on the top risks is critically reviewed and ownership of the mitigation plan is assigned to respective stakeholder, which is monitored continuously. The risks are bucketed into Strategic, Operational, ESG related and Project based.

Even after implementing a well-functioning ERM process, there will always be unknown events- black swans or grey rhinos, that can impact our operations. In such cases, we need to be seamless in our decision making to

ensure safety of our people and other assets. Therefore, crisis management/ emergency response process are implemented at each unit. The crisis management manual details out all the actions that need to be taken, all the stakeholders that need to be informed, the flow of communication and key personnel involved in decision making. These plans are to be stress tested and reviewed annually for their effectiveness, and if need be, modified as per the situation.

Aluminium smelters are of the nature of continuous operations and run 24x7. Interruptions in operations from any plant can have considerable cascading implications across the whole value chain. To ensure continuity of operations for critical and bottleneck processes, we are building resilience in terms of adopting recovery strategies (mainly looking at make-shift arrangement and alternative options) to keep the process running in times of crisis. BCM exercise is currently in its final phase and the final plans at each plant would be ready by second quarter of FY2022-23.

As a culture, resilience is rooted in the way we work and all the three aspects mentioned above were tested during the COVID-19 pandemic. The pandemic was broken down into two risk categories: risks emerging due to lockdown and risks emerging due to the medical crisis. The COVID-19 situation was assessed based on key indicators from other countries like China, US, Italy, Spain, and UK and consequently mitigation plans included working on financial stress testing, solving supply chain issues, arranging for alternate vendors and customers etc. Being a continuous process industry, it was of critical importance to plan for the same, while keeping the safety and health of our employees as the topmost priority.

We have also integrated Task Force on Climate-related Financial Disclosures (TCFD) recommendations in our daily business operations. As a part of the ERM framework, we have identified climate-related risks and opportunities and we have been taking relevant mitigation actions accordingly. Apex sustainability committee is responsible for identifying and mitigating climate related risks and opportunities, which is further supported by our dedicated sustainability team at plants for effective implementation.

The climate-related risks and opportunities are integrated in our strategy by conducting a detailed scenario analysis to understand the impact of climate change on our organisation. We have already implemented resilience measures to mitigate high risk of climate change and tapped several climate-related opportunities by developing diverse product portfolio. More details about our climate related risks and opportunities can be found in the TCFD report available on our website.

Details about the key enterprise risks and their mitigating actions have been mentioned in the table ahead.



# Building Resilience

Description of Risk	Significance	Mitigating Actions	Capitals Affected	Strategic Priorities
<b>R1</b> <b>Increased focus on Decarbonisation</b>	Increased focus on decarbonisation can affect our operations since coal is one of our primary sources of energy. This increases the carbon footprint of the Company.	Coal being one of the primary sources of energy for the Indian operations. Being a continuous process industry, it is difficult to replace with renewable energy source because of the challenges in reliability and storage. However, we have been investing in solar projects to run other operations and the townships on renewable energy. Currently, we have a total renewable capacity of 100 MW. We are also evaluation other energy option including increasing the usage of bio-mass in power plants. We have also been working on carbon capture as well as energy storage.	Natural Capital	SP-3
<b>R2</b> <b>Supply chain risks</b>	Disruption in supply chain would lead to disruption in operations impacting our profitability and therefore sustainability. We are operating at a global level when it comes to procuring and selling products. A large part of our business depends on international trade.	We believe in building strong long-term relations and hence, we have been engaging with our suppliers and logistics partners by signing long-term contracts. Appropriate procurement levers along with stringent vendor management helps to combat the increasing pricing and single vendor dependence. By hedging base commodity coal, Furnace oil also help in containing price increase.	Social and Relationship Capital Financial Capital Manufactured Capital	SP-3
<b>R3</b> <b>Price volatility of Aluminium</b>	The fluctuations in the price of aluminium in INR terms can have a significant impact on the profitability of our business.	We follow commodity and currency hedging strategy through forward contracts. Our approach involves regular reviews and stress tests to optimise the hedge levels. Price offset hedging is followed in copper business to insulate the business from commodity price and currency fluctuations.	Financial Capital Social and Relationship Capital	SP-2 SP-4

Description of Risk	Significance	Mitigating Actions	Capitals Affected	Strategic Priorities
<b>R4</b> <b>Increased import of Aluminium</b>	The increased import of aluminium including scrap may impact our market share.	We proactively engage with our customers to understand and modify customer value offerings. Our downstream product mix strategy is also built to limit the impact from import threats. At present the Finance Ministry has imposed ADD on some of the aluminium products.	Financial Capital Social and Relationship Capital	SP-2 SP-4
<b>R5</b> <b>Solid Waste Management</b>	At present the Finance Ministry has imposed ADD on some of the aluminium products. Proper disposal of waste from operations is essential for environment protection, safety. Some of the waste are stored in secured area where substantial area of land is required. Land availability is becoming difficult and storage of waste in 'ponds' has its own risk as well. New stringent regulations has to be implemented on time bound basis.	We have set up a yoy target of 5% of recycling and reusing waste generated to reach zero waste to landfill by 2030. Several initiatives such as Bauxite residue backfilling, Bauxite residue in road building, long-term contract setup with cement/road developers are in the pipeline and are being monitored on a regular basis.	Natural Capital	SP-3
<b>R6</b> <b>Depletion of natural resources</b>	Natural resource depletion is a risk faced all over the world. This can eventually impact our immediate environment as well operations. Our business growth depends on coal supply, bauxite, copper concentrate, and water etc. Evolving regulations is one of the major risks that we foresee.	We have planned several initiatives for water recycling and rainwater harvesting at various plants. Our aim is to achieve Zero Liquid Discharge and water positivity across mining and downstream verticals by 2025.	Natural Capital	SP-2 SP-3

## Building Resilience

Description of Risk	Significance	Mitigating Actions	Capitals Affected	Strategic Priorities
<b>R7</b> <b>Shareholders/ Lenders focus on ESG</b>	ESG is being viewed as one of the critical areas in the holistic performance of companies. With increased focus on carbon neutrality, transparent business operations, wellbeing of the people and society and the rapid evolving regulations, it makes it imperative for a company to direct its attention towards these aspects.	We are deeply committed to caring for our environment and the people and are aware of the impacts that we have on them. We have set clear goals with respect to E, S & G impacting our business.	Intellectual Capital Social and Relationship Capital Natural Capital Human Capital Manufactured Capital Financial Capital	<b>SP-2</b> <b>SP-3</b>
<b>R8</b> <b>Product development strategy risks</b>	Evolving customer demands and the market is a risk that may impact our profitability.	We have our innovation centres that focus on regularly developing new products. Our commercial team collaborates with key customers to drive joint development projects.	Intellectual Capital Social and Relationship Capital	<b>SP-2</b> <b>SP-4</b>
<b>R9</b> <b>Changes in the regulatory requirements</b>	Being in mining and metals industry, regulations play an important role in shaping the business. Frequent Regulatory changes give rise to uncertainty in the surrounding environment. Our value chain is highly dependent on the resources available with the government.	We continuously engage with Government agencies and work on policy advocacy at various levels. We also actively participate in industry associations activities. This helps us in proactively engaging with the government and be prepared for any regulatory changes.	Financial Capital	<b>SP-2</b> <b>SP-3</b>
<b>R10</b> <b>Cyber Security &amp; Data Protection risks</b>	Organisations are always prone to cyber security risks that can directly impact our business operations, reputation, and customer base.	Focus on formulation of industry standard policies, frameworks along with adopting best practices such as Information Security, Disaster Recovery & Business Continuity Management, IT Risk Management, etc. helps to strengthen the current systems. Periodic assessment of entire IT systems landscape and governance framework from vulnerability and penetration perspective through reputed expert agencies and addressing the identified observations in a time-bound manner.	Intellectual Capital Social and Relationship Capital	<b>SP-3</b>



Plantation on reclaimed mine at Utkal Alumina

### Emerging Risks

We have identified emerging risks as a part of our risk management framework. These risks are complex, and can have unexpected impacts on earnings and market positioning. Additionally, they have the potential to affect our operations and may require us to review our strategy and business model on a regular basis. The identified emerging risks may become significant in due course and impact us directly or indirectly.

### Biodiversity

Loss to biodiversity is one of the risks that is continuously being stressed upon. Our natural habitats are being exploited leading to endangering of various species of flora and fauna. Some of these activities can have irreversible consequences on our planet. The global risk report 2022 by the World Economic Forum has also identified biodiversity loss as one of the top three risks. Loss of biodiversity can impact our operations

significantly since it can attract stringent regulatory policies that can even lead to disruption in business operations. To deal with these issues, we have developed biodiversity management plans, especially for our mines. We have developed four Biodiversity Management Plans for five sites last year in India. Now, we have another five BMPs spanning 10 sites near completion, that will take the total to fifteen sites with detailed 4-season BMPs. The total sites having BMPs stands at 26 out of the 32 critical sites having exposure to biodiversity impacts. Further, details on our approach towards biodiversity management can be found under the Natural Capital section of this report.

### Climate Action Failure and Climate Breakdown

Climate-related risks are being identified as one of the most severe risks for businesses and economies going forward. The world is already witnessing climate change in the form

of unpredictable natural disasters such as floods, extreme temperature, droughts, among others. Currently, the problems that we are facing are complex and dynamic that require everybody to simultaneously engage and work towards a shared goal. Integrating technology, economy and society to transition to a low-carbon future would require combined efforts from all stakeholders including businesses, policymakers and society at large. Failure in transition within the stipulated timelines, could account for societal and geopolitical conflicts, which can have a significant impact on the world. We have undertaken TCFD based assessment to identify climate-related risks and formulate effective mitigation strategies for the long run. Additionally, we have also streamlined our processes to minimise the carbon footprint and move towards net zero goal.





# Stakeholder Engagement

We engage with our stakeholders to identify their key concerns and make continuous efforts to address them collectively and proactively.

Engaging with our stakeholders-both internally and externally on a regular basis, offers us the opportunity to understand their expectations and concerns and subsequently address them in a timely manner. Our Group-level stakeholder engagement policy acts as a guiding principle for undertaking our stakeholder engagement process. It helps in creating long-term value for our key stakeholders.



To engage our stakeholders effectively, we follow a three-step approach:

Identification and prioritisation of key stakeholder groups

Engaging with key stakeholders within each stakeholder groups







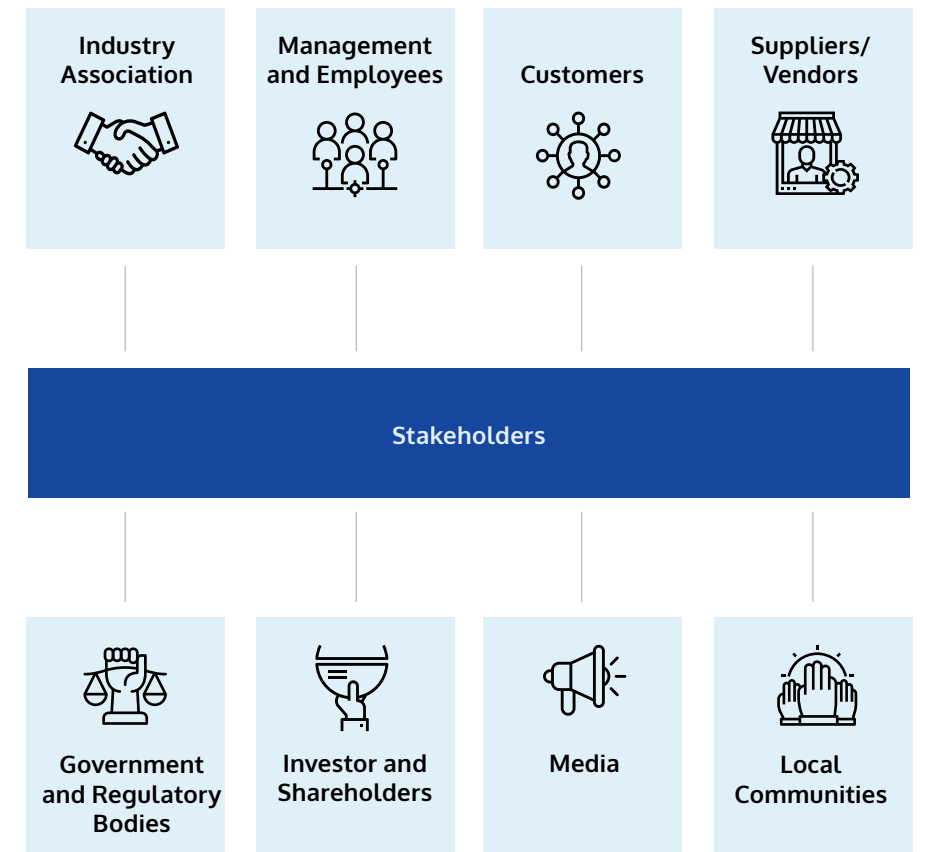

Understanding stakeholder expectations and developing action plans to address concerns, if any.

Key stakeholder groups comprise employees, customers, suppliers and vendors, communities, investors and shareholders, government and regulatory bodies, NGOs, industry associations, and media.









Our engagement is carried out through various modes of channels such as websites, emails, newsletters, social media, physical or virtual conferences and interactions, and by conducting surveys.



# Stakeholder Engagement

Stakeholder	Significance of the relationship	Modes of engagement	Key concerns and expectations	Our approach
 <b>Employees</b>  Continuous	Our employees are an integral part of our journey towards transformational, responsible and sustainable change.	<ul style="list-style-type: none"> <li>E-mails and meetings</li> <li>HI-intranet and knowledge management portals</li> <li>Intranet and Shillim newsletters</li> <li>Leadership townhalls</li> <li>Unit level journals</li> <li>Employee satisfaction surveys</li> <li>Training programmes and workshops</li> <li>Feedback mechanism</li> <li>Performance appraisal reviews</li> <li>Employee engagement programmes</li> <li>Grievance redressal mechanism</li> <li>COVID-19 care</li> <li>Social media platforms</li> </ul>	<ul style="list-style-type: none"> <li>Fair wages and equal opportunities</li> <li>Training and skill development with career growth</li> <li>Rewards and recognition</li> <li>Employee well-being</li> <li>Occupational health and safety</li> <li>Transparent communication</li> <li>Medical facilities and operational continuity</li> </ul>	<ul style="list-style-type: none"> <li>60% of the employees are covered under the provision of collective bargaining at Hindalco</li> <li>100% compliant in terms of payment in minimum wages</li> <li>Providing technical and behavioral training</li> <li>E-learning events and development programmes by Hindalco Technical University (HTU)</li> <li>Awareness programmes on health and wellness</li> <li>Fatality prevention programmes</li> <li>Occupational health and safety training</li> <li>Disaster management plan sufficient notice period regarding any significant operational change</li> <li>COVID-19 management</li> </ul>
 <b>Customers</b>  Continuous	Customers drive sales and are key to process improvements, Quality enhancement, Service performance and Cost optimisation. Hence, our business cannot continue to exist without them.	<ul style="list-style-type: none"> <li>E-mails and meetings</li> <li>Customer satisfaction surveys</li> <li>Periodical site visits</li> <li>Grievance redressal mechanism</li> <li>Social media platforms</li> </ul>	<ul style="list-style-type: none"> <li>Post-sales support</li> <li>Chinese and local competition</li> <li>Sustainable products offerings and solutions</li> <li>Health and safety</li> </ul>	<ul style="list-style-type: none"> <li>Key account management to ensure best possible servicing</li> <li>Net Promoter Score (NPS) model, combination of top down and bottom-up approach</li> <li>Production of aluminium and copper with London Metal Exchange (LME) specification</li> </ul>
 <b>Suppliers/ vendors</b>  Continuous	Suppliers are the brand ambassadors of our products. They play an indispensable role in the product life cycle.	<ul style="list-style-type: none"> <li>E-mails and meetings</li> <li>Vendor assessment and review</li> <li>Supplier audits</li> <li>Training workshops and seminars</li> <li>Stakeholder engagement surveys</li> </ul>	<ul style="list-style-type: none"> <li>Continuity of orders</li> <li>Capacity building</li> <li>Pricing and negotiation</li> <li>Embedded sustainability in supply chain</li> </ul>	<ul style="list-style-type: none"> <li>Policy for supply chain and procurement</li> <li>Supplier code of conduct</li> <li>Risk assessment for suppliers</li> <li>Contractor safety management system</li> <li>Management framework involving ethics and transparency</li> </ul>
 <b>Government and Regulatory bodies</b>  Whenever required	Promote and regulate our actions, ensuring business continuity through compliance with laws.	<ul style="list-style-type: none"> <li>Annual Reports</li> <li>Communication with regulatory bodies</li> <li>Formal dialogues and collaborations</li> <li>Policy advocacy</li> </ul>	<ul style="list-style-type: none"> <li>Tax and royalties</li> <li>Pollution prevention</li> <li>Community development</li> <li>Green economy</li> </ul>	<ul style="list-style-type: none"> <li>Regular payment of applicable taxes and royalties</li> <li>Adoption of cleaner technologies and strengthening of emission monitoring</li> <li>Adoption of renewable energy</li> </ul>

 Frequency of engagement

Stakeholder	Significance of the relationship	Modes of engagement	Key concerns and expectations	Our approach
 <b>Local communities</b>  Continuous	Community engagement enhances our operational efficiency and positive outlook as responsible corporate. It fosters a positive workplace culture and values	<ul style="list-style-type: none"> <li>Stakeholder engagement</li> <li>Surveys</li> <li>Training and workshops</li> <li>Regular meetings</li> <li>Need assessment and satisfaction surveys</li> <li>CSR reports and newsletters</li> <li>COVID-19 care</li> </ul>	<ul style="list-style-type: none"> <li>Infrastructure development</li> <li>Training and livelihood programmes</li> <li>Local employment</li> <li>Participation in social services</li> <li>Community relation through volunteering</li> </ul>	<ul style="list-style-type: none"> <li>Development of community infrastructure in villages such as approach roads, check dams and bus stops</li> <li>Providing skill development programmes for women</li> <li>Focus on livelihood and skill development programmes</li> <li>Social awareness camps</li> <li>Responsible mining</li> <li>Focus on societal reforms</li> <li>Conducting socio-economic baseline study and assessment</li> <li>COVID-19 awareness and provision of medical aid</li> </ul>
 <b>Investor and Shareholders</b>  Quarterly	Provides financial resources to compound business growth	<ul style="list-style-type: none"> <li>Board meetings</li> <li>Annual reports</li> <li>Newsletters</li> <li>Regular business interaction</li> <li>Social media platforms</li> </ul>	<ul style="list-style-type: none"> <li>Sustainable growth and returns</li> <li>Market share</li> <li>ESG commitment and disclosure</li> <li>Operational and financial performance</li> <li>Risk management</li> <li>Corporate governance</li> <li>Ethics and integrity</li> </ul>	<ul style="list-style-type: none"> <li>Continuous operational performance</li> <li>Focussing on cost optimisation and value-added products</li> <li>Enterprise risk management framework</li> <li>Corporate governance framework</li> </ul>
 <b>Industry associations</b>  Periodically	Significant impact on corporate sustainability and offers in-depth advisory on industry trends. These are the routes to interact with industry and the government	<ul style="list-style-type: none"> <li>Meetings and seminars</li> </ul>	<ul style="list-style-type: none"> <li>Regulations</li> <li>Compliance with industry standards</li> <li>Business collaborations</li> </ul>	<ul style="list-style-type: none"> <li>Participation in meetings, conferences and discussions related to industry</li> </ul>
 <b>Media</b>  Periodically	Media helps in projecting our vision and strategy to various stakeholders and, hence, drives growth	<ul style="list-style-type: none"> <li>Digital platforms such as social media and websites</li> <li>Press releases</li> <li>Interviews</li> </ul>	<ul style="list-style-type: none"> <li>Community relations</li> </ul>	<ul style="list-style-type: none"> <li>Transparent communication</li> <li>Communication of our initiatives through integrated report</li> </ul>

 Frequency of engagement



# Materiality Assessment

Materiality assessment helps us in identifying, refining and assessing potential environmental, social and governance issues that could have an impact on our business, and are of interest to our stakeholders. During FY2021-22, we carried out a dedicated materiality assessment exercise to identify material ESG topics.

We identified 12 critical topics that are material to both our stakeholders and our business performance. The material topics were identified based on interaction with our internal and external stakeholders after considering various other relevant factors such as industry research and benchmarking of internal and external forces.

All the issues presented in the matrix are aligned with our principal risks and strategic priorities.

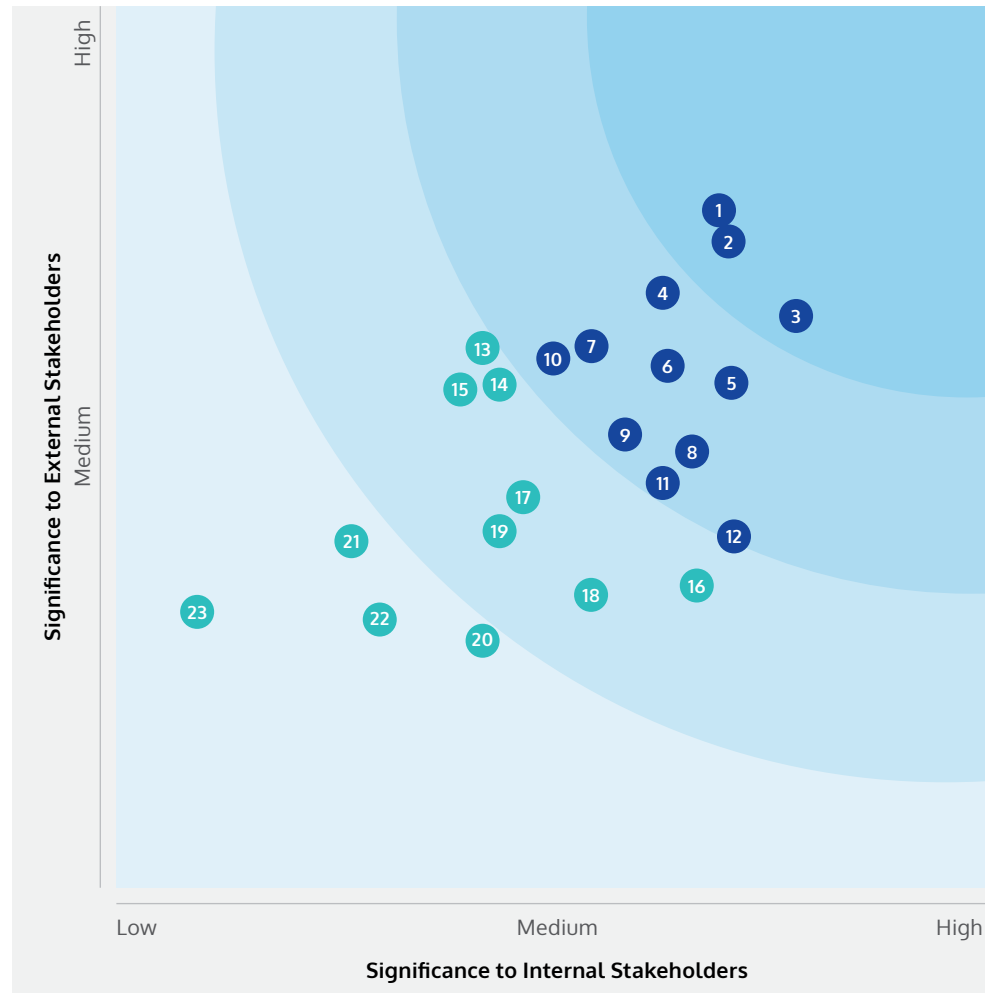

- 1 Energy & GHG Emissions Management
- 2 Water Management
- 3 Occupational Health and Safety
- 4 Ethics and Integrity
- 5 Employee Wellbeing
- 6 Community Relations
- 7 Economic Performance
- 8 Security and Human Rights
- 9 Compliance Management
- 10 R&D Innovation and Technology
- 11 Air Emissions
- 12 Waste and Hazardous Materials Management
- 13 Material Management
- 14 Product Stewardship
- 15 Supply Chain Transformation
- 16 Market Presence
- 17 Biodiversity Impacts
- 18 Digitalisation and Cyber Security
- 19 Diversity and Inclusion
- 20 Communicable Disease and Public Health
- 21 Macro-Economic Fluctuations
- 22 Land Use
- 23 Artisanal and Small-Scale Mining

Material Topic	GRI Topic	SDG alignment	Reference in the Integrated Report	Alignment with Strategic Priority and Risk
Energy and GHG Emissions Management	Energy	7 AFFORDABLE AND CLEAN ENERGY, 12 RESPONSIBLE CONSUMPTION AND PRODUCTION, 13 CLIMATE ACTION	Natural Capital	SP-3 R1
Water Management	Water	6 CLEAN WATER AND SANITATION, 12 RESPONSIBLE CONSUMPTION AND PRODUCTION	Natural Capital	SP-3 R6
Occupational Health and Safety	Occupational Health and Safety	3 GOOD HEALTH AND WELL-BEING, 8 DECENT WORK AND ECONOMIC GROWTH	Human Capital	SP-3 R9
Ethics and Integrity	Ethics and Integrity	16 PEACE, JUSTICE AND STRONG INSTITUTIONS	Corporate Governance	SP-3 R2
Employee Wellbeing	Employment	3 GOOD HEALTH AND WELL-BEING, 8 DECENT WORK AND ECONOMIC GROWTH, 10 REDUCED INEQUALITIES	Human Capital	SP-3 R7
Community Relations	Local Communities	11 SUSTAINABLE CITIES AND COMMUNITIES	Social and Relationship Capital	SP-2 SP-3 R7
Economic Performance	Economic Performance	17 PARTNERSHIPS FOR THE GOALS	Financial Capital	SP-1 SP-2 R3 R4
Security and Human Rights	Human Rights Assessment	16 PEACE, JUSTICE AND STRONG INSTITUTIONS	Human Capital	SP-3 R7 R9
Compliance Management	Environmental Compliance, Socioeconomic Compliance	16 PEACE, JUSTICE AND STRONG INSTITUTIONS	Natural Capital, Social and Relationship Capital	SP-3 R9
R&D Innovation and Technology	Non-GRI	9 INDUSTRY, INNOVATION AND INFRASTRUCTURE, 17 PARTNERSHIPS FOR THE GOALS	Intellectual Capital	SP-4 R8 R10
Air Emissions	Emissions	13 CLIMATE ACTION	Natural Capital	SP-3 R1 R7
Waste and Hazardous Materials Management	Effluents and Waste	12 RESPONSIBLE CONSUMPTION AND PRODUCTION	Natural Capital	SP-3 R5



- R1:** Increased focus on Decarbonisation
- R2:** Supply chain risks
- R3:** Price volatility of aluminium
- R4:** Increased import of aluminium
- R5:** Solid waste management
- R6:** Depletion of Natural Resources
- R7:** Shareholders/ Lenders focus on ESG (Environmental, Social, and corporate Governance)
- R8:** Product development strategy risks
- R9:** Changes in the regulatory requirements
- R10:** Cyber security and Data Protection Risks





# Financial Capital



## Strong, Consistent Performance

Hindalco delivered an exceptional financial performance despite headwinds from rising input costs, pandemic-related disruptions and global inflationary pressures. Our strength was enabled by robust volumes, better operational efficiencies, strategic product mix and improved performance in our downstream business. We are entering new-age markets where we aim to create value out of niche, high-value products. We plan to build on this momentum and prepare to enter the next phase of organic growth with focus on sustained profitability, stronger balance sheet and strategic capital allocation.

### Key Highlights

**₹30,056 CR#**  
EBITDA

**₹13,730 CR**  
PAT

**₹16,838 CR**  
Operating Cash Flow

**1.36x**  
Net Debt/EBITDA

#Exceptional Income/(Expenses) for the the year ended 31<sup>st</sup> March, 2022, exclude ₹418 Crore, which represents the principal portion of (a) PIS/COFINS related tax credit income in Brazil of ₹358 Crore (net of litigation cost of ₹9 Crore) and (b) tax rebates for sales to Manaus, Brazilian Free Trade Zone of ₹60 Crore, as it is included in the results of Novelis segment and is part of EBITDA

### Contributions to SDGs



### Value Enhancing Growth

**SP-1**

Robust capital structure

**SP-2**

Value enhancing growth

### Interlinkages with Material Topics and Other Capitals

#### Material Topics

Economic Performance

Macro-Economic Fluctuations

#### Capitals Connected

Manufactured Capital

Human Capital

Intellectual Capital

Natural Capital

Social & Relationship Capital



### Our Focus Areas

Value Enhancing Organic Growth by Capitalising on Demand Drivers

Sustainable Profitability through Product Mix Enrichment

Strong Balance Sheet

Strategic Capital Allocation Directed Towards Organic Growth



# Financial Capital

## Economic Value Creation (FY2021-22)

Particulars	FY2021-22 (in ₹ CR)	FY2020-21 (in ₹ CR)
Revenue from Operations	1,95,059	1,32,008
Other Income	1,136	1,199
<b>Economic Value Generated</b>	<b>1,96,195</b>	<b>1,33,207</b>
Operating Costs	1,28,686	85,103
Employee Wages and Benefits	11,936	10,782
Payment to providers of capital	4,435	3,960
Payments to government	3,801	1,881
Community expenditure	88	89
Depreciation and other expense	32,509	25,080
<b>Economic Value Distributed</b>	<b>1,81,455</b>	<b>1,26,895</b>
<b>Economic Value Retained*</b>	<b>14,740</b>	<b>6,312</b>

\* Economic value retained = Direct economic value generated - Economic value distributed



## Exceptional Financial Performance

In FY2021-22, our operational and financial performance improved significantly despite headwinds from rising input costs and inflationary challenges. Our continued focus on cost efficiency and integration helped us deliver record financial performance in terms of Revenue, EBITDA, PAT and Earnings per share this year. We are also prepared to enter the next phase of organic growth on the back of a strong balance and healthy ratios.

## Key Financial Highlights (Consolidated)

### Revenue (₹ Crore)

**₹1,95,059 CR**

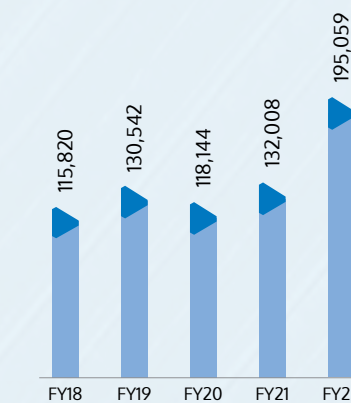

### EPS (₹)

**₹62**

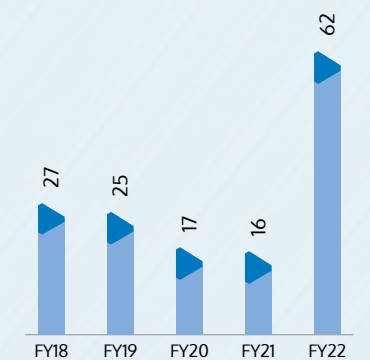

### EBITDA (₹ Crore) EBITDA Margin (%)

**₹30,056 CR**

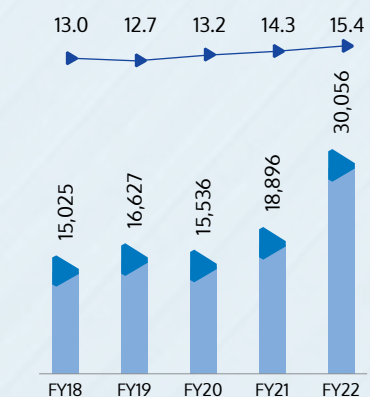

### PAT (₹ Crore) PAT Margin (%)

**₹13,730 CR**

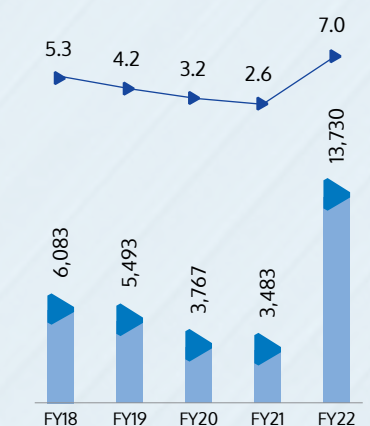



# Financial Capital

## Key Return Ratios (Consolidated)

Debt Equity (in times)

**0.81** Times

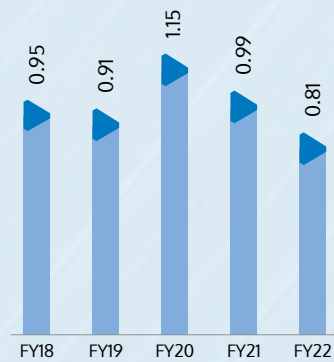

ROE (%)

**18.97%**

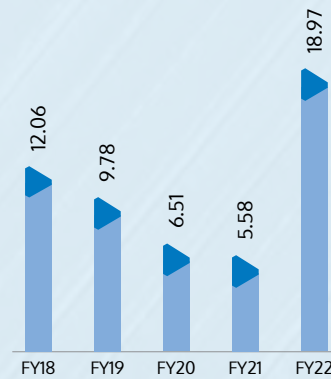

ROCE (%)

**16.61%**

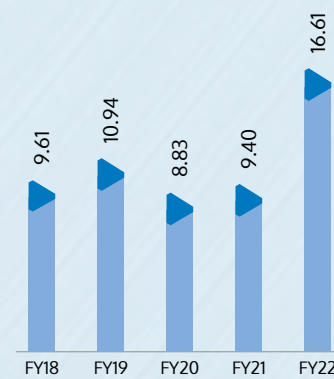

Net Interest Cover (in times)

**7.87** Times

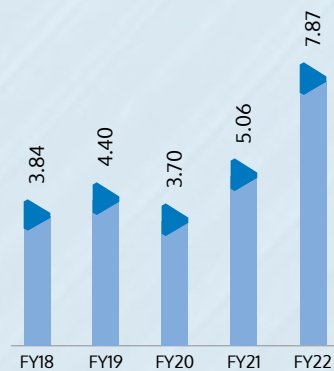

Asset Turnover (in times)

**1.37** Times

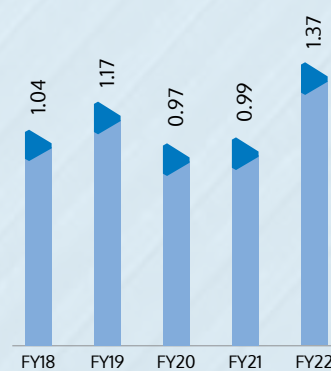

Dividend Payout (%)

**400%**

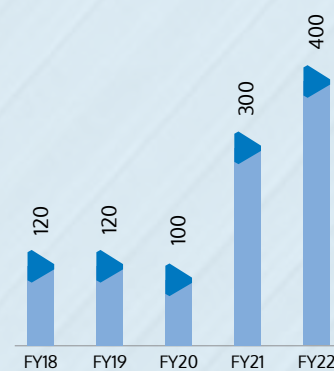

### Value Enhancing Organic Growth by Capitalising on Demand Drivers

As the world's largest flat rolled aluminium producer catering to beverage packaging, automotive body sheets, specialty products and aerospace segments, Novelis is well-placed to gain from the CAGR of 4% in global FRP aluminium consumption from 30 Mn MT in 2021 to 36.3 Mn MT in 2026.

The beverage can segment constitutes 58% of Novelis' FRP shipment, catering to North American, European, South American and Asian markets. Two key factors are expected to drive revenue from the North American markets – rise in consumer demand for FRP products in beverage segment and support for domestic production. The aggressive sustainability targets of key American beverage producers and the demand-

supply gap in beverage can segment, together are expected to contribute significantly towards future growth in this region. Greater adoption of aluminium products and favourable pricing in all markets served by Novelis, are contributing towards the Company's overall growth in this segment.

Despite the headwinds from the pandemic and supply chain challenges over the past two years, the automotive body sheet segment is poised to recover at a healthy rate; supported by pent-up demand for vehicles. Gradual global transition to electric vehicles is also expected to contribute towards growth of Novelis' Automotive Body Sheet (ABS) segment by 2026. Global automotive aluminium FRP demand is expected to grow at a CAGR of 11% between 2021 and 2028.

We also expect strong growth in our high-value specialty segment catering to housing, automobile and packaging

industries, driven by sustainable packaging preferences of consumers. We are positioned to benefit from the recovering aerospace industry.

In India, aluminium demand is expected to double to 8 MMTPA in the next 10 years. This will be driven by the demand from premium urban projects in the building & construction segment, growth in Electric Vehicles (EV), demand from pharmaceutical and food & beverages sectors, along with other industrial applications.

This translates into a CAGR of 6-8% across all major segments. Copper consumption is also expected to more than double in a decade fuelled by demand from infrastructure for smart cities, electric mobility and green energy, among others. This translates to a CAGR of 6-12% in various end user segments.



Utkal Alumina is among the producers of lowest cost, highest quality alumina in the world



# Financial Capital



With the acquisition of Asoj, Birla Copper has strengthened its copper rod manufacturing capacity

## Sustainable Profitability through Product Mix Enrichment

Our margins have improved through stringent cost control and a diversified product mix which has an increased share of high-end value-added products.

### Product-Mix Enrichment:

**In Novelis:** Novelis' strategic investments over the last decade helped us capitalise on favourable market trends of lightweight and sustainable aluminium products as we diversify and optimise our product portfolio. As a global leader in the aluminium and aluminium beverage packaging industries, we leveraged our new capacity and global footprint to increase our sales and capture markets, which improved the pricing for beverage packaging and specialties products. We also increased shipments of premium automotive products which further enhanced product mix.

**In India:** We are expanding our aluminium downstream capacity from the existing 350 kt to around 600 kt by FY2026-27 in the categories of Flat Rolled Products, Extrusions and other value-added products. During the year, we acquired Hydro's Kuppam Extrusions facility to expand our presence in the high-end value-added extrusions and fabricated solutions market. Strategy for copper also focusses on downstream value-added products. We acquired Polycab's Ryker Copper Rods facility in Gujarat of 225 kt to strengthen its copper rod manufacturing capacity by providing a time-to-market advantage taking its total capacity of CCR to 540 kt. We plan to make strategic investments in high-value intermediary component segment of Air conditioning systems with two products, coated aluminium AC fins and copper Inner Groove Tubes (IGT).

## Cost Optimisation Initiatives:

At Novelis, our investments enabled us to increase the amount of scrap recycling. By maximising scrap inputs, driving operational efficiencies and higher utilisation rates, we were able to control and optimise our fixed cost structure. The acquisition of Aleris in 2020 has been highly accretive both in terms of market positioning and synergies.

At our India operations, we have taken several cost optimisation initiatives across the value chain to improve efficiency and reduce the overall cost of production at all our facilities. Access to low cost alumina through Utkal Expansion, better coal mix and other cost saving initiatives, have helped us reduce our cost of production. As a result, we continue to remain in the first quartile of the global cost curve in FY2021-22.

## Strong Balance Sheet

### Ready to fuel the next phase of organic growth

Deleveraging has consistently been one of the core focus areas for our Company in FY2021-22. Company's dedicated efforts on this front have facilitated significant reduction in Net Debt/Adj. EBITDA ratio is halved in FY2021-22 compared to the last year to 1.36 times as on 31<sup>st</sup> March, 2022, vs the leverage ratio from 3.8x as on 30<sup>th</sup> June, 2020.

This provides the company an immense opportunity to fuel its next phase

of organic growth via capacity expansions in both Novelis and India to capitalise on the growing market demand across all the product categories. The company announced its expansion plans of nearly \$8.0 Billion including the projects under appraisal to be spent over next five years, that shall be funded by the Company's internal accruals in line with its capital allocation framework.

## Consolidated Net Debt to EBITDA (x) Trend

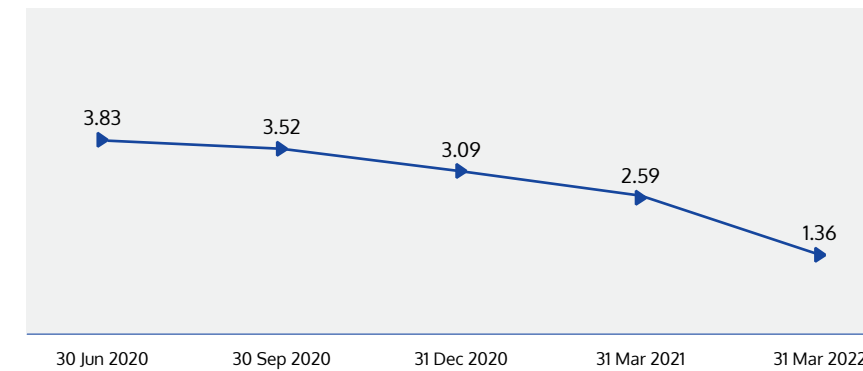

## Strategic Capital Allocation Directed Towards Organic Growth

### Capacity Expansions

Novelis' investment towards organic expansion between FY2018-19 and FY2021-22 stood at \$655 Million; in US, China, and Brazil. Between FY2022-23 and FY2026-27, investment in new capacities and facilities is expected to be more than \$4.5 Billion. This investments to be made in the US, China, South Korea, Germany and Brazil, will cater to the entire portfolio of offerings. Out of the total investment, \$2.5 Billion would go towards a greenfield project of 600 kt low-carbon recycling and rolling plant in Bay Minette, Alabama, primarily to meet the growing demand for cans in North America.

In India business, we have acquired Hydro's SAPA extrusions facility and Polycab's Ryker CCR facility for a total sum of \$79 Million. Utkal alumina expansion of 500 kt, completed this year, takes our Alumina production capacity at Utkal to 2.2 Million MT. The estimated investments in India, spread over next five years, in Aluminium, Copper, Specialty Alumina and Resource Securitisation, is expected to be in the range of \$3 to \$3.3 Billion. This includes certain projects which are currently under appraisal. All these investments are mainly targeted towards downstream capacity expansion which will cater to the growing demand in global and domestic markets. These projects include 34 kt greenfield aluminium extrusions plant in Silvassa, and a 170 kt flat-rolled products facility in Hirakud; aimed at enhancing our value-added product mix. In alumina operations, further debottlenecking is planned at Utkal Alumina refinery for another 350 kt. We have also planned for debottlenecking of smelting capacity by 50 kt at Aditya and Mahan. At Belagavi and Aditya, we would expand specialty alumina capacity by 150 kt in precipitates, white hydrates and synthetic aggregates.





# Manufactured Capital



Striving for excellence with a vision to lead the aluminium industry as the partner of choice for innovative solutions.

We proudly produce metals for the new age which will play a key role in India's transition to Net zero. Aluminium and copper will shape the coming decade, supporting industry megatrends of urbanisation and digitalisation, clean energy & renewables, e-mobility & storage, and electricity as the primary source of energy.

We are the largest flat rolled aluminium producer in the world and the largest downstream aluminium player in India, with a geographical spread across 10 countries with 50 manufacturing units. We are the largest copper player in India serving more than half the requirement of the country. We are working on developing downstream products that will be important in the context of these megatrends.

### Key Highlights

**17**  
Manufacturing units in India

**2**  
facilities acquired - Asoj (Cu CC Rods) and Kuppam (Al extrusions)

**2**  
Operational captive Coal mines

**19**  
Operational Bauxite mines

**33**  
overseas units of Novelis

**500 kt**  
Alumina Utkal brownfield expansion completed

### Contributions to SDGs



### Value Enhancing Growth

<b>SP-2</b> Value enhancing growth	<b>SP-3</b> Strong ESG Commitment	<b>SP-4</b> Portfolio Enrichment
---------------------------------------	--------------------------------------	-------------------------------------

### Interlinkages with Material Topics and Other Capitals

Material Topics	Capitals Connected
Economic Performance	Financial Capital
	Human Capital
	Intellectual Capital
	Natural Capital
	Social & Relationship Capital



### Our Focus Areas

Expanding downstream capacities	Driving operational excellence
Process digitalisation	ESG integration



# Manufactured Capital

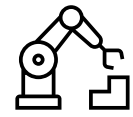

## Production Capacity

**3.6** MN MT

Alumina

**0.36** MN MT

Specialty Alumina

**1.3** MN MT

Primary aluminium

**0.35** MN MT

Aluminium VAP

**0.42** MN MT

Copper cathode

**0.54** MN MT

Copper rods

**4.0** MN MT

Novelis rolling capacity

**2.5** MN MT

Novelis recycling capacity

Our strong focus on world-class facilities, backward and forward integration in the value chain, and our competent workforce makes us one of the world's leading producers of aluminium and copper. This is achieved by our investments in manufacturing capability growth, equipped with robust control measures over our operations and processes. Our manufacturing operations span across the globe with a major market share in aluminium and copper sales.

Our aluminium operations in India encompass the entire value chain from bauxite mining, alumina refining, coal mining, captive power generation to

aluminium smelting, downstream value addition of aluminium rolling, extruding and foils of different specifications. This makes us the largest fully integrated aluminium player in India. Our Utkal Alumina refinery is among the lowest cost, best quality producers of alumina in the world.

At Dahej, we have one of the largest custom copper smelters at a single location in Asia consisting of refinery, and manufacturing of value-added products. Copper operations also include oxygen plants, sulphuric acid plants and precious metals recovery units supported by a co-gen captive power plant.

Novelis, our wholly owned subsidiary, is the world's largest flat rolled aluminium producer and recycler with a rolling capacity of 4 Million MT and recycling capacity of 2.5 Million MT. Our Novelis operations cater to the requirements of the customers of the aerospace and automotive industries in 9 countries with 33 operating units. Out of these 33 units, 15 units have recycling capabilities. This helps us to achieve the objective of sustainability by increasing recycling capabilities and capacities, innovating new technologies, optimising processes, and increasing low carbon logistics.

## Our Production during FY2021-22

### Aluminium



Hindalco India	FY2018-19	FY2019-20	FY2020-21	FY2021-22
Alumina	2,893	2,768	2,699	3,235
Aluminium Metal (Primary)	1,295	1,319	1,229	1,294
Flat Rolled Products (FRP)	289	291	233	301
Aluminium Extrusions	47	41	37	50
*Aluminium Foils and Converted Products	17	18	19	28

### Copper



Copper Cathode	347	326	262	359
Copper Cast Rods	245	245	235	259

\*Foil is a part of FRP production

## Growing our Manufacturing Capability

As a part of our strategic focus on portfolio enrichment, we are expanding downstream capacities in various business segments. On the back of robust domestic aluminium demand, our estimated market share in downstream FRP is expected to grow by 47%. Extrusion and foil market shares are expected to rise to 11% and 15%. We have invested ₹609 Crore in Silvassa to build new extrusions plants with a planned capacity of 34 KTPA. This will serve the fast-growing market for extruded aluminium products in Western and Southern India.

We are entering two new segments in copper– Cu-Mg Alloy rods for railways and Inner Groove Tubes for ACs. The latter is qualified under the Government of India's PLI scheme. With this, Birla Copper is on the cusp of a strong growth trajectory.

### Expanding Geographic Footprint

Despite the pandemic, we effectively used the opportunity to strengthen our manufactured capital. We have expanded our scale by the successful acquisition of two facilities-Kuppam and Asoj.

Kuppam, formerly Hydro's SAPA extrusions facility, has a 15 KTPA capacity with high-end value addition capabilities for surface finishing and fabrication. The Kuppam facility, acquired at ₹247 Crore of enterprise value, offers custom aluminium extrusion products and solutions for auto, building and construction and industrial applications. This will further extend Hindalco's footprint in the Southern part of India, which is the country's second largest extrusions market. The aluminium extrusions market in India is expected to grow from the current level of around 373 KTPA to reach about 850 KTPA by 2030. With the addition of Kuppam



The acquisition of Ryker plant strengthens our portfolio of Copper downstream value-added products

and Silvassa, our total aluminium extrusions capacity will jump from 60 KTPA to 109 KTPA.

The acquisition of Ryker Base Private Limited, now Asoj, is a key step in enriching our downstream portfolio of copper rods. The acquisition made at an enterprise value of ₹323 Crore, provides several strategic benefits, including increasing the Company's presence as a copper rod manufacturer, time-to-market advantage and diversifying its product and customer portfolio.

Also, the plant is well aligned with Hindalco's ESG focus. Asoj's copper wire rod facility uses German technology, consumes less energy and has significantly low carbon emissions.

### Future Growth and Expansion Plans

With the objective of expanding our aluminium downstream business, we have announced various projects. The 34 KTPA capacity extrusions plant at Silvassa is scheduled to produce its first billet in FY2022-23. We have started to expand the FRP production capacity at Aditya Aluminium and Hirakud plants by 170 KTPA with a planned investment of about ₹2,690 Crore.

To support the increased volume of downstream production, we are planning brownfield expansions at Utkal Alumina, Aditya Aluminium and Mahan Aluminium. Utkal Alumina has already expanded by 500 kt in FY2021-22 at a rough investment of ₹1,788 Crore and another 0.2 MMTPA increase in capacity is planned this year. Our plants at Aditya and Mahan are due to get an 18-pot expansion each at a cost of ₹417 Crore and ₹429 Crore

Under the Prime Minister's Atmanirbhar Bharat campaign, we are adding AC coated fin-stock capacity of 26 KTPA at Taloja under the Production Linked Incentive (PLI) scheme. This project will serve the requirements of downstream customers.

Novelis has also announced a \$2.5 Billion (₹18,997.50 Crore) greenfield, fully integrated rolling and recycling plant in the US to support strong demand for aluminium beverage packaging and automotive solutions. This will be the first fully integrated aluminium facility built in the US in 40 years. It is expected to provide up to 1,000 high-paying jobs in modern manufacturing. The plant will make significant use of state-of-the-art automation including Artificial Intelligence, augmented reality and robotics. In addition, we are well-positioned to efficiently expand capacity at this facility in the future – above the 600 KTPA announced previously – to capture ongoing strong demand.

# Manufactured Capital

## Project Management Framework

We have developed a Project Management Framework (PMF) to establish a consistent approach to manage complex capital project over their lifecycle and ensure we achieve the cost and time targets. This will enable better visibility and accountability on project execution and strengthen our decision making. Key processes in the PMF are:

## Reinforcing Operational Excellence : Way to Continuous Improvement

We strive to accomplish operational excellence by investing in right capabilities and capacities. To boost yields and improve efficiency, we rapidly adopt new-age technology solutions and streamline costs, processes and methodologies. Our initiatives such as Maintenance Strategy and Execution Framework (MSEF), introduction of Opportunities, Ideas and Concepts (OICs), etc., complement our aim to achieve operational excellence. We carry out World Class Manufacturing (WCM) and several other initiatives to enhance the current processes.

As a part of our efforts to strengthen our management system and processes, all our corporate offices and 17 of our manufacturing units have been certified with integrated management systems. This includes all the necessary certifications for Quality Management System (ISO 9001), Environment Management System (ISO 14001) and Occupational Health and Safety Management System (ISO 45001). In addition, six of our units - Aditya Aluminium, Utkal Alumina, Renukoot complex, Mahan Aluminium, Hirakud Power and Smelter and Birla Copper at Dahej are ISO 50001 certified.

In the world of rapid digitalisation and dependence on information technology systems, data security has become critical to business and consumers. Hence, we have further strengthened

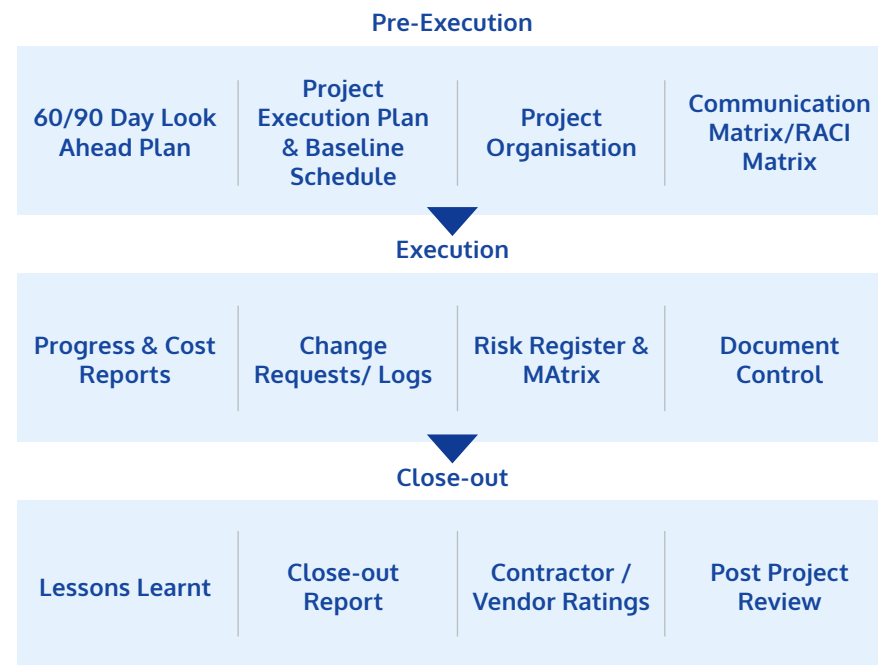

our systems and implemented the Information Security Management System (ISO 27001) across our operations in the previous financial year.

Our Alupuram extrusion, Renukoot downstream and Hindalco-Almex Aerospace Limited (HAAL) plants are certified with AS 9100 certifications, qualifying them to make automobile and aerospace grade products. Additionally, our Mouda plant has been granted a Bureau of Indian Standards (BIS) license and has received the approval for manufacturing of marine class supplies. Along with Alupuram, Belur and Renukoot downstream plants have also qualified for NABL ISO/IEC 17025 certification. Our Taloja operation has received IATF 16949 certificate for high quality automobile grade aluminium production. Mouda has become our first plant to achieve Aluminium Stewardship Initiative (ASI) performance standard certification. All our products are Restriction on Hazardous Substance (ROHS) compliant, and we conduct periodical testing

through National Accreditation Board for Testing and Calibration Laboratories (NABL) accredited labs to ensure that we do not exceed the prescribed limit of restricted materials.

To meet the requirements and expectations of our customers, all the Novelis's manufacturing sites are certified with internationally recognised management systems – ISO 9001 or ISO/TS 16949 Quality Management System Standards. Over 80% Novelis locations are ISO 14001 or EMAS certified, while seven sites have internally certified Environment Management System.

Novelis also caters to the requirements of aerospace customers through two certified plants at Koblenz, Germany and Zhenjiang, China. Both these plants are certified with accreditations of DIN EN ISO 9001, EN 9100/AS 9100, ISO 14001, NADCAP – Heat Treating, and NADCAP – Non-destructive Testing.

## Maintenance Strategy and Executive Framework

Maintenance is one of the key levers to deliver business outcomes. For a manufacturing unit, it is imperative to have a sustainable equipment management policy to ensure that there are no unplanned or unforeseen breakdowns of equipment or systems. To avoid such circumstances and minimise the magnitude of risk, we have developed a comprehensive asset management policy, termed as Maintenance Strategy and Execution Framework (MSEF). Successful implementation of MSEF has helped us achieve better plant uptime.

The entire framework is based on a continuous loop of Plan, Do, Check, Act (PDCA) principles. This constitutes dipstick testing on a bi-annual basis, formulation of an implementation plan, implementation assistance, re-checking improvements in the next assessment, and the cycle of maintenance continues.

The framework is divided into multiple sub-process areas which directly or indirectly aids in equipment maintenance. Each sub-area has a collection of best practices either in form of strategic initiatives, practices, or results that are produced. The MSEF audit is a robust system which uses a lifecycle approach to manage assets.

## Downstream reliability

We have been continuously upgrading our current installations to deliver value to our customers. Some notable technological upgrades for Reliability & Productivity Improvement in Hindalco Downstream are:

- New CBL Line @ Renukoot – Augmenting capacity of Circle Blanking by 700 MTPM.
- New Degreasing Line at @ Renukoot – 2000 MTPM.
- New 6" Press @ Renukoot Extrusion – Press No. 9 – approx. 4000 MTPA - With advanced quenching system, Log Heater facility- Giving Recovery & productivity advantage and higher specific pressure enabling to cater critical profiles.



All of Novelis's manufacturing sites are certified with internationally recognised management systems



# Manufactured Capital

## MSEF framework checklist

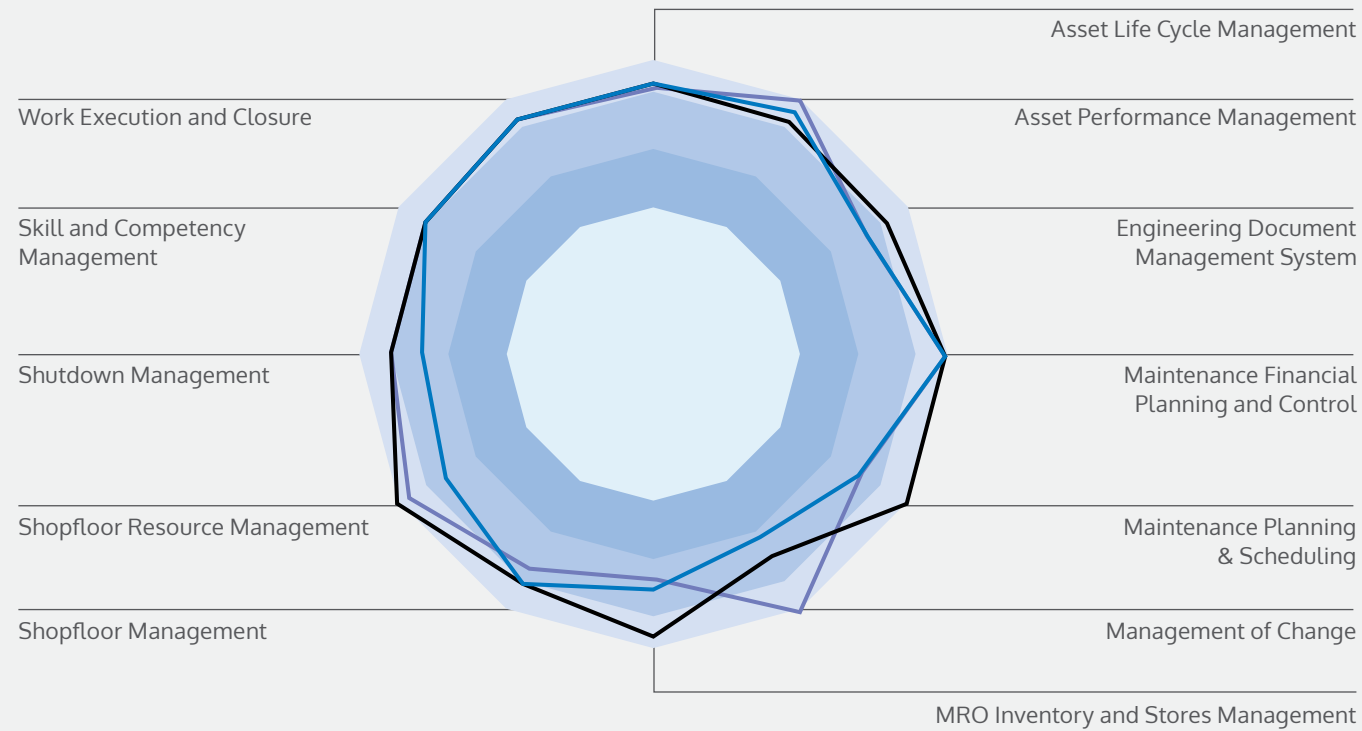

- Downline Upgrade at Press 2 – By Sunwoo, Korea giving us advantage to serve critical products and cater the market where manual dragging is prohibited.
- X Ray Upgrade at Belur SMS Mill – Upgraded to IMS from earlier Thermofisher make - giving Reliability advantage, almost 3% jump in Utilisation.
- New Anodising station at Taloja.
- Re-Commissioned RFI & Overhauled EMS (Electro Magnetic Stirrer) at Hirakud DC4 Cast House for critical product casting like CBS.

### ARTIFICIAL INTELLIGENCE (AI) IN PREDICTIVE MAINTENANCE FOR ASSET RELIABILITY

Appreciation Asset maintenance is critical for maintaining manufacturing plant efficiencies. We are leveraging the technologies available in the new digital era of Industry 4.0. Digital sensors are being mounted on equipment to monitor the health of the equipment. Data collection, data analysis, failure prediction and prescriptive maintenance are being followed depending upon the criticality of equipment.

We have partnered with leading technology providers to drive predictive maintenance initiatives across our plants. How equipment responds to process variation is mapped by a Machine Learning algorithm which triggers alerts when inputs cross a certain threshold.



Hindalco's deployment of mechanical and robotic automations has helped us improve process efficiencies

## Progressing Towards Industry 4.0

At Hindalco, we have identified and deployed several mechanical and robotic automations opportunities to improve equipment reliability, productivity and process efficiency. Our team engaged with leading industrial robotic solution providers to implement suitable solutions to the identified opportunities.

Advancements of new technologies have helped us to improve process efficiencies, optimise resource consumption, and deliver better quality and energy reduction. Below are some of the key technological and digitalisation initiatives taken by plants in collaboration.

- Caustic reduction in alumina refineries through new filtration technology
- In-house patented new cathode design change for energy efficiency improvement
- In-house magnetic compensation loop for pot lines

- Digital twin for smelters and refineries.
- Equipment health prediction with data analytics.

### Machines at Work

We are working on several projects and solutions to drive the Company's digitalisation and automation projects through use of robotics.

### WORKPLACE SAFETY IN CONFINED SPACES

To ensure workplace safety, we have deployed robotic system with a remote operation to perform hazardous operation of sludge cleaning in a risk-free manner.

This technology can be used to remove the sludges from confined spaces like tanks, vessels, pits, sumps, underground drains, and cooling tower basins without manual intervention.

### ROBOTICS IN RELIABILITY ENGINEERING

There are many digital survey activities, inspections, Non-Destructive Testing (NDT), etc., being carried out at our plants, utilising advanced methods such as-

- Drone survey of stacks to eliminate huge scaffolding erection works and associated risk with height works.
- Robotic lizard-crawler with ultrasonic thickness measurement instruments to measure the thickness of tanks, vessels, chimneys, boiler tube thickness mapping.
- Digital scanning to develop drawings for the entire steel and civil structure in a complex including static asset condition appraisal etc.



# Manufactured Capital



## Future of Technology

### HOT METAL HANDLING AREA – SAFE WORK PRACTICE IN HARSH ENVIRONMENT

To protect our workers from workplace hazards and prevent or minimise work-related injuries and diseases, we pursued a developmental initiative with one of the service providers. We will make use of robotics for skimming of dross from moulds of the ingot casting machines.

Our Manufacturing Centre of Excellence (MCoE) team along with the plant team is exploring options to automate this process. One of the viable solutions that has been considered is Automatic Tuyere Punching Machine for PS Converter. The tuyere hole punching operation will be done from remote location and thus, the operator need not be experiencing hot and harsh environment. This will eliminate manual intervention and thus improve workplace safety.

### DIGITISATION AT BIRLA COPPER: POWERING DIGITAL TRANSFORMATION WITH INDUSTRY 4.0

**Key digitisation initiatives undertaken through FY 2021-22 include:**

**Acoustic Steam Leak Detection system (ASLD)**  
Implementation of ASLD has helped in detecting the sound waves emanating from the steam leak or tube leakage transforms into electronic voltage signal, which is then amplified, filtered and processed. This system indicates the quantum of steam leak and the location. By using these methods, the leaks were detected and secondary damages and unscheduled outages were avoided.

**Electronic Level Drum Indicator (ELDI)**  
The importance of water level monitoring in a boiler drum cannot be over-emphasised. We installed Electronic Level Drum Indicator (ELDI) that helps in monitoring water level including alarm and tripping at pre-set levels. This eliminates the need for periodic maintenance or calibration unlike other level monitoring solutions.

## Working Towards a Common Goal

As a part of Hindalco’s Operation Collaboration projects, our teams across different plants have taken up various projects to improve operational efficiency. One such significant project is reducing Auxiliary Power Consumption (APC) in Captive Power Plants (CPP). At Hindalco, we have CPPs operational at Aditya, Mahan, Hirakud and Renuagar. As part of the mega collaboration initiative across these four locations, our teams worked together with the objective of finding possible ways to reduce APC. The result was encouraging and led to a significant reduction in APC from 8.2% in 2015-16 to 7.6% in FY2021-22. This also resulted in reduction of 55,000 tCO<sub>2</sub> GHG emission.

## Consistent reduction in the Auxiliary power consumption in CPP Benefits - 180cr/Annum as per baseline figure

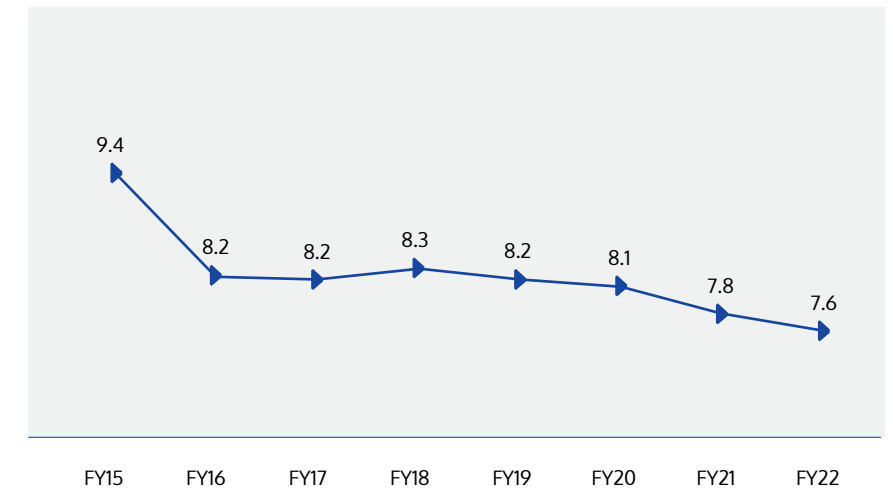

Hindalco has a comprehensive quality management process to ensure customer satisfaction

## Improving Downstream Quality through Build Quality in Process (BQiP) Framework

We continue to monitor quality and delivery parameters in downstream businesses. To complement the effort, we developed BQiP framework which helps in identifying the strengths and opportunities for improvement in downstream operations.

The BQiP assessment is carried out at Hirakud, Taloja, Renukoot FRP and Extrusion, Belur, Mouda and Alupuram. The evaluation process comprises 24 criteria including Material Handling, Packing and Storage Standard, RCA & Horizontal replication of learning (Reliability Calls), Computerised Maintenance Management System (CMMS), and others. The result of the BQiP assessment shows a 4% yoy improvement for the FY2021-22 over FY2020-21.

During the year, we implemented additional process improvement projects resulting in efficient utilisation of resources, reduced energy consumption and enhanced product quality and safety.



## Manufactured Capital



### Some of the additional process improvement projects taken up by our units in FY2021-22 as below:

#### Alupuram

Alupuram completed several process improvements projects such as log heater reliability improvement, "D"-furnace temperature uniformity improvement, and tear off concept - deep tongue die. To improve the reliability of log heating system, we undertook a series of actions. For instance, we started to track the use of data history for

troubleshooting of any log heater issue and avoided illogical discard by installing two new sensors in line.

As a result of it, log heater utilisation has improved substantially over the last years. We were also able to save cost and improve efficiency by elimination of manpower and time involvement for cutting billets and its transportation.

#### Mouda

Mouda took up a project to improve the running speed and utilisation of M5 Finishing mill from 60% to 75%. In foil business, we use M5 finishing mill which caters to the entire light gauge product portfolio. However, during the manufacturing process, we observed flatness issue. With the objective to resolve the flatness issue of light gauge foil, our team collected and analysed data for eight to ten months.

After comparing different combinations of coil specifications, we found the importance of entry tension in the physical shape of light gauge foil.

As a result of the implementation of project, there was a drastic reduction in the number of bad shape coils over the month. We developed a dashboard in Intelligent Plant Framework (IPF) platform for close monitoring of critical KPI's related to M5 flatness and interlinked SMS alert in case of any deviation against standard operating range of rolling parameters.

We also created a digital platform to integrate parameters of upstream process for ease in data analysis on a daily basis. The project is in its early stage and is targeted to achieve the desired outcome by December 2022.

### NOVELIS DELIVERING VALUE-ADDED PRODUCTS (VAPS)

Our subsidiary Novelis is among the world's leading suppliers of high-quality aluminum rolled products for the aerospace and industrial plate industries. To support aerospace customers' sustainability targets, we built a 151-feet (46 m) multi-spindle, five-axis Computerised Numerical Control (CNC) milling machine in our Zhenjiang, China facility.

The goal was to automate the manufacturing process that can offer products with improved buy-to-fly ratio. With multi-spindle CNC, we were able to reduce cycle time and improve productivity.



### IMPROVING SMELTER PRODUCTION USING COPPER COLLECTOR BAR (CUCB)

To improve the current distribution and productivity, copper-inserted collector bar has been proven as a standard choice. During the year, we undertook several initiatives to reduce energy consumption such as:

- New lining design incorporating copper insert collector bar pots
- Digital twin in trial phase for predicting and improving pot performance
- Improving current efficiency by operating at optimised pot parameters

- Better pot instability control and temperature control
- Pot voltage adjustment in CuCB pots by optimising Force Convection Network (FCN).

As a result, we were able to achieve an average current of 368.8 ka at Mahan and 367.5 ka at Aditya, respectively. This led to a production gain of 5.7 kt in FY2021-22.





# Manufactured Capital



Hindalco has focused on operational efficiencies under WCM to stay future ready

## World-Class Manufacturing

The concept of 'World-Class Manufacturing' helps us to implement best practices, focus on operational efficiency and develop cost-efficient methods which keep us future-ready in today's fast growing and competitive world.

We held Kaizen competitions across all our mining units. With the implementation of 1,067 Continuous Improvement (CI) projects, we were able to achieve a saving of ₹72.05 Crore in FY2021-22. A total of 25,919 Kaizens were submitted from our employees across locations demonstrating active participation.

**₹72.05 CR**  
Saved through continuous improvement projects

## Aditya

A total of 4,519 Kaizen projects were submitted by the employees working at Aditya aluminium. The team submitted a project with an objective of achieving sustained improvement in the processes by reducing auxiliary power consumption by 50 kWh/pump in Aditya CCP.

As a result, the unit was able to save power of 80 kWh/pump and overall annual saving of 3.5 Million kWh. It resulted in a total cost saving of ₹1.3 Crore in FY2021-2022.

## Mahan

Mahan submitted 6,492 innovative ideas, completed 101 CI projects and was able to save ₹1.71 Crore from the implemented projects in FY2021-22.

These activities were targeted at improving operational efficiency and reducing overall costs. Following are some of the projects which have resulted in changes at various levels:

- Enhancement of productivity in coal handling plant by installing 50 additional carrying idlers and reducing space between idlers from 1,200 mm to 400 mm
- The existing hexagonal bolt was replaced with counter shrunk to avoid breakdown time of Cast House Tending Assembly (CHTA) block gear box assembly

## Hirakud Complex

Our employees at Hirakud submitted a total of 5,943 kaizens, aimed at improving asset reliability and efficiency. Some of the projects are:

- Eliminating the issue of bladder safety valve damage, resulted in saving of ₹3 Lakh in two months
- Enhancing coolant quality by avoiding mixing of sludge and hence minimising the regrinding of roll. With this initiative, we were able to save a total of ₹50,000



## IDEAS OF ALL SIZES- EMPLOYEE-LED INNOVATION PROJECTS

Our culture of innovation and technological excellence has led to process improvement. This was evident again at our Utkal operation. Our Utkal plant experienced a sudden breakdown at Rotating Magnetic Field (RMF) due to which support beam of the pressing plate filter got damaged and production was halted. The OEM team gave a timeline of 10 months to deliver the spare, which was not feasible for the plant. Hence, we fabricated the same at the workshop.

Our team came up with a solution to convert the existing lathe machine to planner machine by reversing the operation of the lathe machine (tool fixed on to the chuck and job on the tool piece). Because of this, we were able to avoid ₹28.33 Crore of production loss. This was an example of operational excellence achieved by our teams.

Some of the other kaizens that resulted in optimised performance at reduced production cost are:

- Avoided plant blackout in case turbine generator in island mode trips, resulting in a cost saving of ₹1.59 Crore
- Installed screw charger in place of table feeder to control the dust in Milk of Lime (MOL) area. This project is expected to save ₹1.07 Crore/year

Utkal has been able to submit a total of 132 Kaizens and 126 completed CI projects in FY2021-22.





# Human Capital



## Nurturing our talent

Our people are our biggest asset and the key drivers in our journey towards building a Greener, Stronger and Smarter future. They have delivered seamlessly with resilience, passion, empathy, care, and speed throughout the pandemic and continue to do so.

With a workforce of more than 68,500 across the globe, we remain committed to building an agile, responsive and productive work environment in line with our strategic priorities of value enhancing growth and strong ESG commitment.

At Hindalco, through employee-centric systems and processes, we ensure the overall wellbeing, health and safety of our employees. We invest in capacity and capability building with specific focus on new ideas and skillsets catering to an evolving business landscape.

### Key Highlights

**7.22%**  
Women employees

**₹10.5 CR**  
Investment in trainings and skill development

**2,912**  
New hires

**3.5 MN**  
Training hours

### Contributions to SDGs



### Value Enhancing Growth

SP-2

Value enhancing growth

SP-3

Strong ESG Commitment

### Interlinkages with Material Topics and Other Capitals

#### Material Topics

Employee well-being

Diversity and Inclusion

Occupational Health and Safety

#### Capitals Connected

Financial Capital

Intellectual Capital

Social & Relationship Capital



### Our Focus Areas

Organisation Effectiveness

Human capital Development

Diversity and Inclusion

Employee well-being and Human Rights

Occupational Health and Safety



# Human Capital



Hindalco's focus on building an empowering culture helps us create a High Performance Contemporary Organisation

We make continuous efforts to enhance employee experience, instill a better sense of ownership and build an empowering culture that helps us create a thriving, high speed and 'High Performance Contemporary' organisation.

As we focus on value-driven growth, we continue to nurture a culture of excellence. Over the years, our employee-centric policies, processes and practices have helped us build a safe and progressive work environment. We reinforce workplace safety by continuously identifying areas for improvement and work towards implementing them from time to time.

We are an equal opportunity employer and have zero tolerance towards discrimination and harassment at workplace. We uphold human rights and work in alignment with international standards to protect the rights of our employees. Our feedback platforms enable employees to report grievances, which are addressed in a time-bound manner.

## Organisation Effectiveness

Our employee-centric approach improves efficiency and productivity. We make continuous efforts to engage our employees through various tailored programmes.

## Employee Productivity

Enhancing productivity and keeping our employees motivated during these challenging times has been our priority. We embarked upon this journey through innovative initiatives to improve organisation effectiveness. We organised virtual wellness sessions focussing on mental and physical health during and post the pandemic. These expert-led sessions were attended by more than 1,400 employees. We also started 'Art of Parenting' session for our employees and their spouses to understand parenting in changing times and support them through this crucial phase of life.

Our Group's five Values of Integrity, Passion, Commitment, Seamlessness and Speed are the guiding force for our employees and businesses.

Some of our business level initiatives like 'Brainbooster' and 'Avishkar' for all our Hindalco units are innovative ways through which we ensure our employees live by these core values. Brainbooster focussed on enhancing customer experience by leveraging our Values. For all our Hindalco units, we organised Avishkaar competition wherein our managers designed artwork based on our Values. More than 350+ future leaders of Hindalco participated in these competitions.

Another unique initiative is our Values month celebration across plants, mines and corporate locations covering almost 85% of our employees through initiatives like values quiz and recognition, storytelling sessions, trekking, sports, art and craft activities, exhibitions, leadership talks, etc.

At Hindalco, we strongly believe that listening to employees improves job satisfaction and employee productivity. Through our listening initiative 'MEffect', we sought feedback from our employees on overall managerial capability of

their managers. Each manager received feedback from his or her team, based on which the managers prepared action plans for future.

Furthermore, we conduct a biennial survey known as VIBES and TEAM VIBES with the help of a third-party agency. This survey is available in various languages for the ease of employees. The survey helps us seek inputs from employees on various parameters such as agility and alignment, employer brand, performance culture, and manager effectiveness. This survey is carried out across the organisation for management cadre employees.

During the reporting period, survey witnessed 91% participation with score of 85% in employee engagement against a target of 90%.

In recognition of our efforts towards building a culture of High-Trust and High-Performance, we have been certified as a Great Place to Work by the Great Place to Work Institute in 2021. This reflects a strong emotional connect employees have with the organisation as well as the brand's contribution to society which the employees are extremely proud of.

### A DAY TO APPRECIATE THE EFFORTS OUR EMPLOYEES

We celebrated Appreciation Day on 4<sup>th</sup> March, 2022, to acknowledge the talent of our capable and committed workforce. Despite market disruptions, pandemic and an ever-changing external environment, our workforce delivered the best results, adding value to our Company. Furthermore, we made appreciation notes and festive-like arrangements to make this event special for our employees.

### APNI ZIMMEDARI - DRIVING CULTURE AT HINDALCO

At Hindalco, hundreds of our managers meet annually with a goal to further strengthen a contemporary culture that is centred around ownership, openness, inclusion, collaboration, and meritocracy. During our first meet at Shillim, we drafted our Purpose statement- 'We manufacture materials that make the world Greener, Stronger and Smarter'. Eventually, these annual meets came to be known as the Shillim Movement.

The purpose of these meets is to bring teams together to shape the future path of Hindalco. This year, the fifth edition of Shillim, our theme was 'Apni Zimmedari' which translates to 'Our Responsibility'. We inspired people to step up and take ownership for a more accountable, responsive, inclusive, collaborative, and agile culture. During this meet, we align our plans to build a solid foundation for the global 'High Performance Contemporary Organisation' that we aspire to become.







# Hindalco Organisation Effectiveness (OE) Calendar FY2021-2022

## Integrator



### People Champion

Workshops for  
Wellness Champs  
Q1

Wellness workshops  
for Managers  
Q2-Q3

Wellness Awareness  
Session  
One every month

Hygiene Charter &  
Awareness Camps  
Q1-Q4



### Values

Values Celebration  
December and  
February

Values  
Reinforcement  
Q1 – Q4

## Enabler



### Recognition

Pride Awards  
Cycle 1: Q1  
Cycle 2 : Q3

Champion of  
Champions  
Q4

Employee  
Appreciation Day  
Q4 - February

Praise Platform  
Q1-Q4

Chairman's Award  
Q3 – Q4



### Scholarship

AWOO & Pratibha  
Scholarship  
Q1-Q4

AWOO Donation  
Campaign  
Q2

## Change Agents



### Shillim

Shillim 5.0 at  
Business  
Q4

Shillim 5.0 at Units  
Q4



### Employee Voice

MEffect Survey and  
Manager Action Plan  
Q4

Manager Vibes Report  
and Action Plan  
Q4

Vibes Survey

GPTW  
Q3

## People Champion



### Diversity

Gender Intelligence  
& Unconscious Bias  
Sessions  
Q2-Q4

Interaction with  
Women Employees  
Q2-Q4

Psychological Safety  
Sessions for Managers  
Q2-Q4

WAH Conclave  
Q4

POSH Awareness  
Q1 - Q4



### Communication

Business Townhall  
May, Aug, Nov, Feb

Cluster/Unit  
Townhall  
April, Sept, Jan

# Human Capital

## Employee Strength

The breakdown of employees for our India operations is given in the table below. We have 2 expats from USA, while rest of the employees are Indian.

Employees (Breakdown by Numbers) (FY2021-22)			
Employee Category	Aluminium and mines	Copper	Total
Manpower Strength	49,936	4,961	54,897
Management & Staff	7,477	575	8,052
Management & Staff (Male)	6,894	537	7,431
Management & Staff (Female)	583	38	621
On-roll workmen	13,221	1,013	14,234
On-roll workmen (Male)	13,132	1,008	14,140
On-roll workmen (Female)	89	5	94
Contract workmen	29,156	3,508	32,664
Contract workmen (Male)	28,079	3,278	31,357
Contract workmen (Female)	1,159	95	1,254

Number of Management Employees (Age-wise)			
Year	>50 years	30-50 years	<30 years
FY2018-19	1,188	2,395	473
FY2019-20	1,232	2,436	598
FY2020-21	1,137	2,582	601
FY2021-22	1,348	2,437	579

Number of Staff Employees (Age-wise)			
Year	>50 years	30-50 years	<30 years
FY2018-19	606	2,053	945
FY2019-20	648	2,019	913
FY2020-21	568	2,068	914
FY2021-22	662	1,947	1,079



Hindalco has created a robust talent retention strategy

We do not discriminate with respect to sexual orientation, race or ethnicity in our hiring process. Novelis' employee strength is approximately 12,690.

During the reporting period, we hired 890 employees in India, and 2,022 employees at Novelis. Percentage of our open positions filled by internal candidates was 14.16%. Our average hiring cost per employee is ₹25,948. Breakdown of new employees hired in FY2021-22 with respect to age and gender has been provided in the table below.

New employees hired in FY2021-22	
Category	Total
Total employees hired	890
Employees hired - Male	747
Employees hired - Female	143
Employees hired (> 50 years old)	24
Employees hired (30- 50 years old)	330
Employees hired (<30 years old)	536
Junior management	778
Middle management	17
Senior management	95

## Employee Turnover Rate

For this reporting year, our voluntary employee turnover rate was 4.6%. Details of the classification of total employee turnover rate are mentioned in the table below.

Total employee turnover	Number of Employees Separated	Rate (%)
Total employee turnover	404	5.02
Employee turnover – Male	355	4.78
Employee turnover – Female	49	7.89
Employee turnover (> 50 years old)	44	2.19
Employee turnover (30-50 years old)	187	4.27
Employee turnover (< 30 years old)	173	10.43

## Talent Retention Strategy

We are committed to building a diverse workforce and vibrant work culture that provides holistic growth and development opportunities. Following are our talent retention strategies:

- **Ring Fencing** - At Hindalco, we use this strategy for setting aside funds in the form of deferred compensation for our key employees.

- **Market correction** - It is offered to our top performing employees to be positioned strongly in the market, in terms of salary.

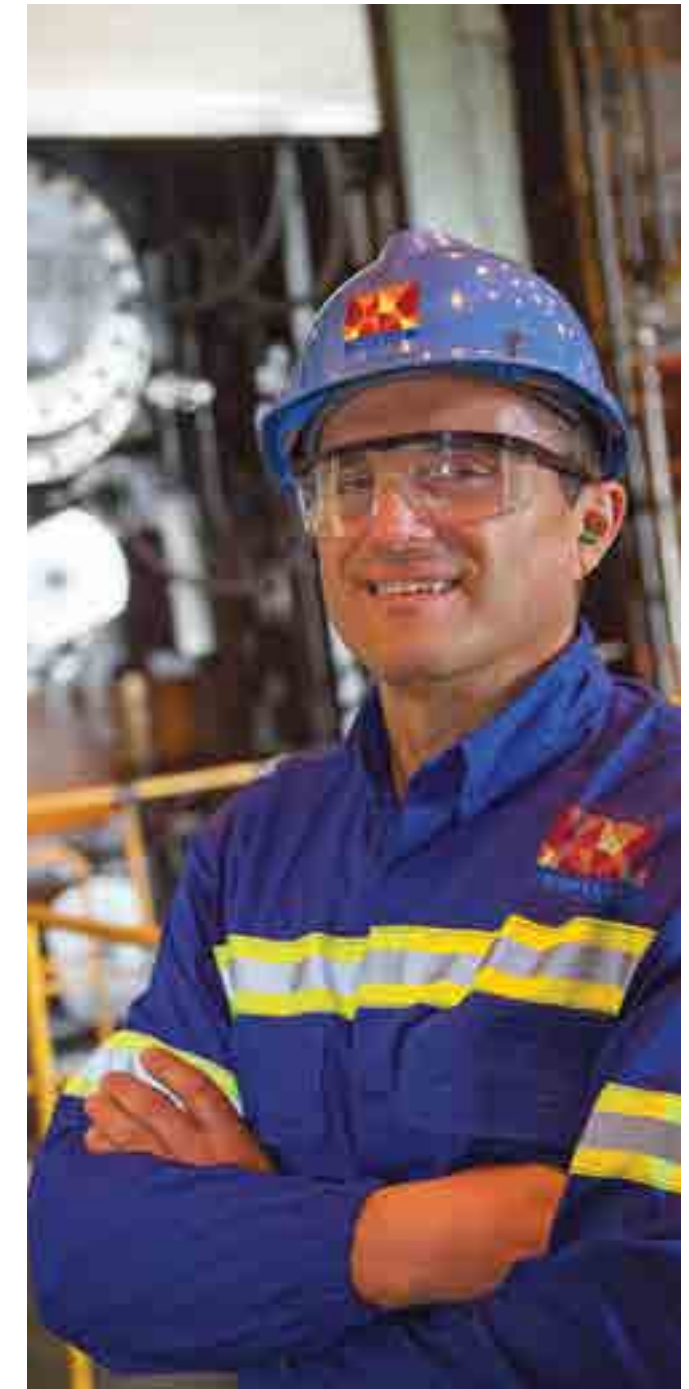



# Human Capital

## Performance Evaluation

Our performance evaluation process is systematically structured to recognise and reward employee performance through a transparent evaluation mechanism. The process starts with goal setting by employees at the beginning of the year. These goals are set in alignment with business needs, and a roadmap is created along with timelines, to achieve the goals. Mid-year assessment and yearly performance reviews are undertaken to evaluate and assess employee performance. The manager evaluates performance on a five-point rating scale.

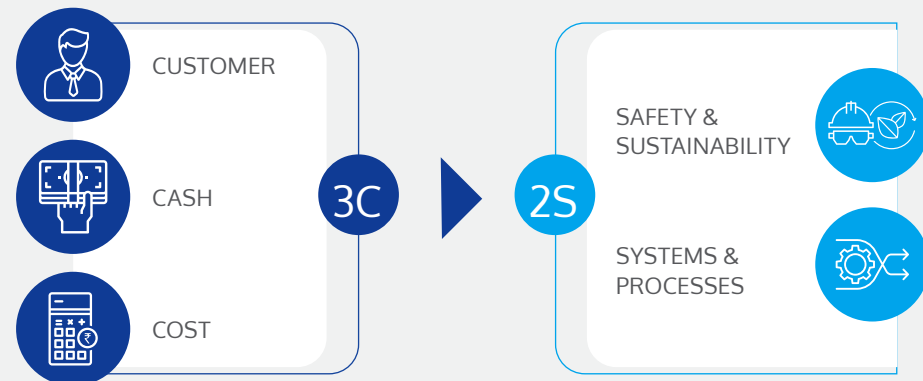

Our Review Framework aligns organisational objectives with individual goals. With this framework, we concentrate on critical aspects of our overall business. The 3C + 2S framework plays a key role in boosting employee productivity. The performance evaluation is based on goal-wise assessment, career aspirations and relative performance of team members.

Managers take support of 360-degree feedback, with use of our bespoke platform "PingMe", for employees, to help them further in their career growth. To ensure transparency and fairness

of performance evaluation, employee ratings are validated by multiple levels of reviews from top management.

The Managing Director's goals are defined by the Company's 3C + 2S principle. Customer centricity and product development is a focus area with dedicated objectives on sales and customer satisfaction. The cash and cost goals focus on profitability, cash flows, production and cost optimisation. The sustainability goals cover Hindalco's performance in air, water, waste, biodiversity, climate management and overall ESG performance. System and process goals cover digitalisation,

HR planning and driving culture. Performance evaluation is linked to the achievement of these goals. ESOPs are allocated based on performance, and vesting depends on the performance of the business in the preceding year.

We also have a focussed learning intervention for people managers on managing biases. Apart from individual performances, we also encourage our employees to participate in team-building exercises and collective thinking to tackle professional challenges. All our employees receive regular performance and career development reviews.

## Human Capital Development

### Talent management strategy

Talent management strategy is a core principle of Hindalco's people policy. A few pillars of our strategy include:

Hiring of young talent	Learning and Development	Gender Diversity	Focus on building technical/specialist capability	Increased people movements
700+ from campuses over the last 5 years	Structured training and development programmes during the first-three years of hiring	30%+ female hires from campus	42 employees selected for special skills training	10% yoy increase

## Learning and Development

We believe in holistic development of our employees and want them to excel in technical skills, behavioural competencies as well as functional capabilities. Our learning and development efforts include internal and external trainings, focussed group trainings, e-learnings, coaching, mentoring, on-the-job training (OJT), workshops and seminars. Each employee is guided by their manager to develop their skill roadmap through My Development Plan (MDP) on ABG's central HR platform, Poornata.

### Capability Development for Future Leaders

In order to nurture future leaders through specialist technical career paths, in the reporting year, we identified 42 employees to develop special skills and expertise and sent them to United Arab Emirates for a year for training. Plans are afoot to deploy 25 employees to Novelis for a three-year period to acquire skills related to downstream business.

We have designed leadership programmes for our future leaders i.e., managerial employees to build the right competencies at every career stage. Our top talent is encouraged to undergo these leadership programmes.

Some of the key development programmes are:

- **Ascend Sales Academy** - This three-month programmes focusses on building interpersonal skills and creating business effectiveness for sales and marketing employees.
- **XSEED (Excellence in Skill Enhancement and Employee Development)** - A leadership programme for our junior managers on team development, goal setting, building agility and resilience.
- **FLY (Future Leaders in You)** This programme focusses on self-development of junior managers and leading a team in a digital environment.

- **FFFD (Fit for Future by Design)**- This 15-month programme is about discovering self, developing business acumen necessary for transition in career from a specified function or operational path.
- **Copper Leadership Series** - This programme is targeted towards middle managers to deliver superior performance and be result oriented in their current roles, take accountability and drive initiatives on their own to enhance performance. The above-mentioned trainings helped groom our future leaders and enabled them to build capabilities for better teamwork, time management, risk taking and communication.

### Training for our Board of Directors (BODs)

We follow structured orientation and a training programme known as 'Familiarisation Programme' for the Independent Directors to understand the business and operations of Hindalco. We welcome a new Director to the Board of Directors by sharing various documents like introduction of Hindalco, profile of BODs and senior management, code of conduct, latest annual and sustainability reports, etc. This reporting year, the Familiarisation Programme was attended by six of our Independent Directors for a consolidated training time of 30 hours.

## Approach for Identifying New Training Programmes

Our human resources team is responsible for supporting training and development activities for management and non-management level employees.



The details of programmes identified by HR and attended by our employees is tracked by our Cornerstone on Demand (CSOD) platform.



Employees of Birla Copper's Asoj plant

# Human Capital

## Other Trainings

### E-learning

The outbreak of COVID-19 led us to shift the majority of our trainings to a virtual platform. We promoted Gyanodaya Virtual Campus (GVC) application and other digital platforms to encourage e-learning and approximately 2,482 employees downloaded the application.

### Sustainability

ESG focussed trainings were conducted to hone the skills of people as 'Water Champions', learn biodiversity management, waste accounting and waste-to-value models and build greenbelt development capacity. The e-learning courses include environment, law, reporting, disaster management, and other topics.

### Risk Management

Our employees undergo several risk management trainings as it is important for us to identify and mitigate any threats or risks pertaining to our operations. Enterprise Risk Management (ERM) sessions are organised for our employees monthly in collaboration with Hindalco Technical University. These sessions are carried out on rotation for three to four plants and 50-100 nominated participants. Apart from this, sessions on ERM framework and business continuity management are conducted monthly by our risk managers and risk champions at units. We are planning to create a pre-recorded course for our employees who wish to deepen their knowledge of ERM. We also conduct quarterly Board meetings on ERM to discuss the current market trends.

Employee training category	Unit	Aluminium and Mines	Copper	Total
Risk Management trainings	Hours	1,624	406	2,030
E-learning hours	Hours	334,287	23,560	3,57,846
Sustainability/ESG trainings	Hours	6,017	181	6,198
Safety trainings	Hours	1,85,504	15,560	2,01,604
Human Rights trainings	Hours	2,171	0	2,171

Average training hours per Employee for Hindalco are mentioned below. Average amount spent per Full Time Employee (FTE) on training and development is ₹2,927.

Category	Hindalco						Novelis	Total (Hindalco and Novelis)
	Aluminium and Mine			Copper				
	Male	Female	Total	Male	Female	Total		
Total training man-days	1,07,099	3,584	1,10,683	6,448	156	6,605	3,24,186	4,41,474
Training man-days (Management & Staff)	63,762	3,339	67,101	3,568	136	3,705	1,62,510	2,33,316
Training man-days (On-roll workmen)	43,337	245	43,582	2,880	20	2,900	1,61,676	2,08,158
Average training hours per employee	43	42	43	33	29	33	191	98
Average training man-days per employee	5.32	5.21	5.32	4.16	3.63	4.15	23.86	12.31

We also continuously measure the impact and effectiveness of these trainings for our employees by implementing the Kirkpatrick Model of evaluation. We have classified the evaluation process into four levels.

- L1 Evaluation (Feedback on Content and Trainer by the participants after the session)
- L2 Evaluation (Post training assessment to check the knowledge gained by participants)

Applicable only for certification programmes of HTU).

- L3 Evaluation (Change in behaviour of participants after 60 days)
- L4 Evaluation (To meet the training objective and Return on Investment)
  - (i) L4-A: Meeting the Training Objective
  - (ii) L4-B: Calculating Return on Investment



Augmented Reality training is a major thrust area

### Hindalco Technical University

The Hindalco Technical University (HTU), established in 2017, offers programmes tailored by technical experts to ensure relevance with current trends and operational requirements.

HTU has created schools for Power, Smelter, Mining and Refinery in association with industry professionals. These schools have run 43 programmes involving 3,406 participants till date totaling 17,989 learning hours. These programmes are designed and tailored to industry requirements and in line with our motto 'Technical Competency building through Schools of the people, for the people, by the people'. Going forward, we are planning to open schools catering to copper manufacturing and downstream operations.

### New Training Initiatives at HTU

During FY2021-22, we started three new training initiatives for our employees to strengthen their skills in niche areas.

- Specialty Knowledge Integration Programme (SKIP) - This initiative was started to ensure focussed learning on specialty chemicals business as we plan to expand our portfolio of specialty chemicals. We started this initiative at Muri and have conducted six sessions to date with more than 150 participants
- Intellectual property rights (IPR) – This training strengthens the IPR portfolio and protects the intellectual property of technical resources. We have carried out five sessions on IPR with participation of more than 200 employees
- Data Analytics through Artificial Intelligence (AI) and Machine Learning (ML) - In this initiative, we help our plant professionals to understand key crucial process parameters through big data analysis. We have conducted one session on this so far and more sessions are planned for the future

### HTU: Key Highlights FY2021-22

- 30+ programmes in collaboration with external partners covering 900+ participants
- 179 training programmes with participation of more than 14,000 employees from Aditya Birla Group Businesses
- 24 safety and sustainability programmes attended by more than 3,000 employees

As a way forward, we plan to develop more intellectual property by encouraging and building internal training resources. We aim to broaden HTU's programmes to include supervisors and workmen. We are in the process of further strengthening our programmes through strategic collaborations with academic experts and research institutions.



# Human Capital

## DOWNSTREAM TRAINING INITIATIVES

To understand and operate our fully automated aluminium extrusion plant at Silvassa efficiently, we selected 42 of our employees from diverse educational backgrounds for a structured capability building programme in Dubai, UAE to be a part of this one-year training provided by prominent extrusion leaders in the world.

The learning method adopted was 70-20-10 wherein 70% of training was covered by industrial visits and operations of Kuppam and Silvassa plant. 20% of the training was covered by subject matter experts and mentors in India with the help of a review process. The remaining consisted of classroom and online training. This training helped our employees comprehend better about the essential process in our fully automated plant.

## ALUMINIUM STEWARDSHIP INITIATIVE (ASI) PROGRAMME

To train our employees on global responsible business practices, we started the Aluminium Stewardship Initiative (ASI) certification. Our employees from select departments at Renukoot, Taloja, Belur, Mouda, Alupuram and Hirakud FRP participated in this programme held on 24<sup>th</sup> and 25<sup>th</sup> March, 2022 in Kolkata.

The programme concentrated on implementing ASI performance standard, to meet customer expectations, demonstrating sustainable practices to external stakeholders and addressing sustainability aspects in the value chain. The training also focussed on business integrity, policy and management, transparency, material stewardship and case studies.

## LEADING INCLUSIVELY - DIVERSITY AND INCLUSION INITIATIVE AT NOVELIS

To work towards our commitment of a more inclusive workplace, Novelis designed 'Leading Inclusively Workshops' for managers to help them on their journey to become more inclusive leaders. The workshop sessions offered some strategies for leading inclusively as a first step in our commitment to make Novelis an inclusive workplace. These workshops were facilitated by diversity and inclusion Subject Matter Experts (SMEs) and Novelis Culture Champion. The facilitators helped our leaders to:

- Understand concepts of Unconscious Bias
- Learn strategies to interrupt unconscious bias and be a more inclusive leader
- Value diversity and the opinions of others
- Learn concepts of micro-aggressions and psychological safety



Hindalco promotes a diverse and inclusive workplace

Through various Organisational Effectiveness (OE) programmes, we pursue diversity by appreciating the differently abled. We have 13 differently abled permanent employees. We remain committed to safeguarding our employees by providing equal opportunities. We strictly adhere to our organisational policy as to not differentiate between our employees based on their colour, caste, creed, gender, nationality, religion, and race.

Harassment, whether sexual or non-sexual, is a way of discrimination. At Hindalco, we respect the dignity of every person and interdict all forms of harassment. We make planned efforts to support our employees with a gender-neutral, bias-free and healthy working environment. We abide by the Prevention of Sexual Harassment (POSH) policy which ensures strict actions on any employee found guilty of sexual harassment. New joiners are sensitised to the POSH concepts and company POSH policy during their induction process. To ensure compliance with

POSH Act, 2013, we have formed Internal Complaint (IC) committees at all our locations. Circulars released by IC are regularly communicated to employees and cases are reported and registered through the IC, portals and helplines.

This year we reported six cases and took appropriate action. We did not receive any cases against discrimination at workplace during this reporting year.

## Diversity and Inclusion

Workplace diversity not only drives more creativity and innovation but also enhances the capability of an organisation to tackle several challenges by bringing in a more holistic perspective. At Hindalco we focus on diversity not just in terms of numbers but also harness diverse talent to build a stronger and more resilient organisation.

Our share of women in total workforce increased from 7.00% in FY2020-21 to 7.68% in FY2021-22 for our India operations. We achieved this by hiring women from campuses, promoting women to senior roles and at the executive level. Furthermore, our Board of Directors comprise two female representatives. We plan to increase the percentage of women in STEM to 5.75% by FY2022-23. Our approach towards diversity is bottom-up and we continue to focus on developing a strong pipeline of home-grown women managers. Over 30% of our management trainee hires have been women over the last few years.



Hindalco has sent women from Silvassa plant for international exposure to extrusion plants in Dubai

	Current Share During FY2021-22	Target for FY2022-23
<b>Representation of Women</b>		
Share of women in total workforce (as % of total workforce)	7.68	8.50
Share of women in all management positions, including junior, middle and top management (as % of total management positions)	7.37	8.50
Share of women in junior management positions, i.e., first level of management (as % of total junior management positions)	7.74	9.00
Share of women in top management positions, i.e., maximum two levels away from the CEO or comparable positions (as % of total top management positions)	-	2.50
Share of women in management positions in revenue-generating functions (e.g., sales) as % of all such managers (i.e., excluding support functions such as HR, IT, Legal, etc.)	4.80	6.00
Share of women in STEM-related positions (as % of total STEM positions)	4.70	5.75

# Human Capital

## Diversity and Inclusion Initiatives

- ‘Soaring High’ programme for our women managers to build leadership capabilities and accelerate their growth. We ensure women are adequately represented in cross-functional team projects.
- ‘Springboard’ programme for women employees comprising classroom teaching and cross-functional/ business projects spread over 18 months.
- ‘Dual Career Policy’ enables employees and their spouses to pursue their careers within the Company by offering positions at same location.
- ‘Women at Hindalco’ series for our women employees giving them an opportunity to listen to inspirational women leaders, join in discussions, build POSH awareness and recognising exceptional Women at Hindalco.
- 46% of the IC Members participated in POSH refresher programme and they, in turn, trained 3,000+ employees across all our units.
- We have an e-learning course on diversity and inclusion on Gyanodaya portal which provides all the details regarding POSH Act and the need for inclusion across gender and geographies.

### WOMEN AT HINDALCO

With more and more women joining manufacturing, this industry is witnessing a change in the workforce demographics. At Hindalco, we support a diverse and inclusive culture through policies to ensure safe and comfortable working environment for women employees.

Our ‘Women at Hindalco’ initiative is encouraging women to work on the shopfloor. We help our employees climb the corporate ladder by inspiring them to take on key responsibilities and challenging tasks and break out of their comfort zone.



**Ankita Ekka, Alumina operations at Renukoot**

“Operators se meri dosti ki shuruyat chai se hui thi” - Ankita Ekka from Renukoot’s Alumina operations. Working at the alumina plant environment in Renukoot is a scary proposition. Working 8-hour shifts

in areas full of dust and caustic fumes which cause skin irritation is another downside. Plus, being area-in-charge of A or B shift entails handling production, quality, manpower management and operator discipline at once. This is a tall order for anybody and many girls were unwilling to take up these shifts because of the awkward environment.

Tea was a great place to start. Ankita started taking her cup over to the operators shed during tea breaks. “Initially, it was a bit uncomfortable for all of us, but I started asking them to share their safety concerns – which is a big issue in any plant. Initially, they were hesitant to speak but when they saw that I had made it a daily practice, they began to come to me with their problems,” says Ankita.

Today, Ankita manages 25 to 30 operators in a shift. If there’s a problem to be solved or a leakage to be handled, she stays with them till the end of the shift to ensure everything is in order. She is visible and very much in charge and the operators have accepted her as one of them. “The shopfloor is my favourite place – I like talking to people and being a part of the process of creating something and this is where the action is,” says Ankita.

There are many such women at Hindalco, persevering through all challenges and making their mark on the shopfloor.

## Employee Well-Being and Human Rights

Medical insurance to self and family members	Plant township accommodation	Group personal accident insurance	Hospital facility	Commute arrangements to employees
--	------------------------------	-----------------------------------	-------------------	-----------------------------------

Employee well-being is a key pillar of our HR strategy and we are committed to enrich the lives of our employees across the value chain. All our permanent employees are entitled to various benefits and programmes such as paternity leave, maternity benefits, health insurance, life insurance, etc.

We encourage collective bargaining and freedom of association to our employees as good practice even at the contractors’ end. A total of 60% of our on-roll workmen are a part of trade unions and are covered by collective bargaining agreements. We always respect the law of the land and India’s constitutional framework.

According to our organisational policy and Maternity Benefit Act, all our management and staff employees are entitled to avail parental leave. Our maternity support programme is aligned with our vision of being an ‘aspirational place to work’ for women. It supports our employees in one of their critical life events, of becoming a mother while continuing to excel in their professional journey.

The programme design enables employees to integrate their personal and professional commitments seamlessly during this period (until the child turns two) without any negative impact on their compensation, employment status, performance rating and talent rating. To the expecting women employees, we offer benefits like:

- **Maternal leave** - A female employee is entitled to 26 weeks of paid leave with an option to add 60 additional days by combining privileged leaves. A provision to avail a total of 5 paternal leaves is also present for male employees.
- **Support in local commute to work for expecting mothers in metro and mini-metros** - Designed to offer a safe and comfortable local travel to work for expecting mothers.
- **Accompanied outstation travel for mothers (infant and caregiver)** - Support a new mother in her transition back to work and ensure that she does not miss out on important official travel.
- **Healthy pregnancy programme** - To provide easy access to health education and online solutions to take care of herself and her baby during and after pregnancy.
- **Phase back programme for seamless transition** - We offer flexible work options like work from home, work from satellite office and part-time working to new mothers and mothers-to-be, enabling them to seamlessly transition into maternity leave and join back work.
- **Transition guide** - To guide employees on emotional well-being and aspects of balancing personal and professional commitments during this critical juncture.
- **Career management support** - To ensure minimal impact of maternity on the career of an employee by securing her performance and talent ratings.
- **Child adoption leave** - To offer comprehensive leave support to women employees and enable them to assimilate the adopted child in the family.
- **Miscarriage leave** - All women employees can avail six weeks leave in case of a miscarriage, in alignment with the Maternity Benefit Act 1961.
- **Childcare facilities** - Our corporate mothers can avail the new childcare facility at our head office.

Some other employee benefits include:

- **Privilege leave** - All employees are eligible for privilege leave, which can be availed for taking a leave for more than three days. Annually, a total of 30 PLs are provided at locations having 6-day work week and 26 PLs are provided at locations having 5-day work weeks. These leaves can also be accrued and later cashed out. This gives the employees more time with their loved ones.
- **Flexible working hours** - At Head Office (HO), employees can start any time from 7 am to 10 am and can opt for 4 days a month as work from home.



# Human Capital

To address employee grievances, we have a grievance redressal process in place in accordance with the Whistleblower policy wherein our employees at all Hindalco units can register their complaints. These complaints are addressed by the supervisors, and we try and resolve them swiftly and seamlessly.

Salaries and remuneration are strictly driven by the qualifications and experience of our employees. At present, there is no female representation at the Executive level. We offer salary and remuneration ratio of 1:1 for female to male at executive level.

In management positions, average male base salary is ₹5,71,641 (₹19,39,143 total remuneration) while average female salary is ₹399,381. (₹14,30,935 total remuneration). For non-management employees, the average base salary for males is ₹1,87,910, while for females it is ₹1,57,398.

## STEPS TAKEN FOR EMPLOYEES DURING COVID-19 PANDEMIC

During the pandemic, we extended our medical coverage to our employees, their families and contractual workers. We vaccinated more than 20,000 of our employees and contractual workers.

This year, we started setting aside a particular amount to save lives so that there is no financial burden on our employees. We gave additional rewards to our employees for going the extra mile during these challenging times.

To protect the interest of our employees in case of any operational changes, we offer a notice period of 60-90 days for our employees and 21 days for our workers as per Section-9 of Industrial Disputes Act, 1947.

During this reporting year, 8,052 employees were entitled to parental leave.

Parameters	Male	Female	Total
Total employees who took parental leave during FY 2021-22	212	5	217
Total number of employees who returned to work in the reporting period after parental leave ended	211	5	216
Total number of employees who returned to work after parental leave ended and are still employed 12 months after their return to work in 2021-22	205	4	209
Return to Work Rate (%)	97.00	100	99.53
Retention Rate (%)	97.61	100	98.13

## HINDALCO WELLNESS CIRCLE

In the Hindalco wellness circle, we focus on four key pillars: physical, emotional, financial and social. Our first pillar 'Physical' focusses on the physical wellbeing of our employees. We carry out regular health check-up camps and nutrition sessions for our employees led by experts. We promote hygiene awareness in all our units and carry out fun activities like Zumba sessions, marathons and sport days.

'Emotional' part concentrates on mental health of our employees. We have dedicated 'Mpower' grief management sessions for our employees who have lost their loved ones.

Our employees undergo one-on-one sessions with trained counselors to deal with emotional distress. We have carried out 48+ sessions which helped

our employees to deal with the loss of their loved ones. We have trained 54 volunteers from all Hindalco units to become an emotional ally to provide support and point employees in the right direction if they require professional assistance. Our emotional first aiders are trained to promote good mental health recovery and protect those who are of harm to themselves.

'Financial' pillar emphasises on investment and retirement plans of our employees to secure their future. Our last pillar 'Social' focusses on employee and community wellbeing. It is mandatory for our employees to engage in community service once every quarter. Recognising the importance of employee wellness, we have built recreational centres and hobby clubs for employees to spend their leisure time.

## MENTAL WELLBEING

We organised mental health sessions from 5<sup>th</sup> to 11<sup>th</sup> May, 2021 for all our employees and their families who were COVID-19 positive or were quarantined. Our employees reported that these sessions helped them deal with the uncertainty more effectively and helped them stay calm even during these challenging times.



In its remote locations, Hindalco offers a range of activities for employees and families to unwind

## Human Rights

At Hindalco, we are committed to protecting our employees and abide by our human rights policy. We have policies in place to safeguard our employees and contractual workmen against harassment and discrimination. These policies are aligned with the principles of the following laws:

- International Labour Organisation (ILO)
- United Nations Global Compact (UNGC)
- Data Privacy Policy
- Prevention of Sexual Harassment (POSH)
- Equal opportunity employer policy
- Indian labour laws (Child labor, Women migrant labour, Abolition Act, etc.).

## Protecting our Employees and Workers

Our Contract Labour Management System makes sure that our workforce registered is above 18 years of age.

Further, the risks related to human rights are captured by our risk management framework called Hindalco

Management Framework (HMF) at all plant locations. Rojnama, an online compliance tool has been introduced at our units. Our HR teams ensure that the compliance details are fed into this tool regularly. This data is audited by an external agency, with follow-ups done by legal compliance audits that incorporate human rights and labour laws. To ensure risk mitigation related to human rights, a risk register is maintained relating to working environment, human rights, legal and occupational issues along with health and safety across all the units. The risk mitigation plan addresses risks associated with employees and local communities. All our units and mines comply with this plan. We have prepared a Human Rights Due Diligence tool which takes inputs from Sedex Members Ethical Trade Audit (SMETA) tool. This tool has been introduced as a pilot project at Utkal and it will be implemented across Hindalco units after receiving feedback and inputs. We also make sure that the minimum wages received by our workers are in accordance with The Minimum Wages Act, 1948. We have a system in place for identifying and mapping human rights risks in new business relations and all identified risks are periodically reviewed through our ERM process

annually. This reporting year, we did not report any human rights violations, hence, no remediation actions were required.

We carried out training programmes for our employees as well as our security personnel. All our security personnel are covered under human rights training programmes for prevention and mitigation of any human rights violation. The total training man-hours provided to security personnel and our employees are provided in the table.

Category	Total
Total training man-hours provided to security personnel for human rights training	226
Total training man-hours with respect to human rights for employees	2,171

## Protecting Indigenous Communities

We had zero cases reported against us related to violation against rights of indigenous people. Our HR department at all Hindalco units are responsible for handling such incidents. We work in co-operation with our communities and local bodies to support the indigenous people of the area.



# Human Capital



Hindalco's Zero Harm policy includes a robust safety framework

## Occupational Health and Safety

At Hindalco, our goal is zero work related casualties. This goal led to the creation of a 'Zero Harm' policy for which we have designed a robust safety framework. This framework includes our state-of-the-art health and safety management system. The entire system covers all our employees, contractors, business associates, visitors and the community as well.

We have attained ISO 45001 (2018) certification for our manufacturing units and mines. Being an advocate of 'Zero Harm', it is imperative that we identify high risk activities in our manufacturing units and assess them thoroughly to take required preventive measures. To ensure better safety monitoring, we have installed

CCTV cameras and Video Enabled Data Analytics (VEDA). We have also installed a sustainability data management system called Enablon to monitor Behavior-based Safety (BBS).

Apex Safety Board, which is at the top of our safety hierarchy further consists of Unit Safety Boards. Each of the units have six safety sub-committees namely Safety Standard Implementation sub-committee, Incident Investigation sub-committee, Safety Audit and Assurance sub-committee, Safety Training sub-committee, Behavior Based Observation sub-committee and Contractor Safety Management sub-committee. These sub-committees are responsible for implementing and monitoring safety protocols across the organisation.

Some of the key initiatives undertaken in occupational health and safety are mentioned:

- Management of Change (MOC)- A document that gives information on procedures at the time of a process change covering impact assessment procedure, risk management and risk mitigation.
- Robotic descaling of tank
- E-permit system
- Residual life assessment with crawler for structural stability (RLA)
- Infrared automation for hot-spot detection in green anode plants
- Monitoring and inspection of work done at height through drone technology

## Safety Trainings

We develop and focus on relevant safety training modules for all our employees and contractual workers during induction. Three days of safety training is compulsory for each employee, and it is a part of the refresher course on corporate policies, standards and safe work practices for occupational hygiene hazards.

With respect to safety audit findings, history of incidents, safety department inputs, our Corporate Safety function identifies new training for individuals based on work profile. Our safety training and programmes are carried out by safety professionals who are highly trained and competent. They are assisted by the line managers under the guidance of our Corporate Safety Cell. Furthermore, standard implementation sub-committees also help to recognise employees who need specific knowledge skills. We make sure that our employees have all certifications and licensing as required by applicable government regulations.

Due to COVID-19, we arranged most of our training programmes either virtually or physically in small batches to ensure that we follow all the precautions and maintain social distancing. With the new trend of a hybrid working model, we introduced a training course on COVID-19 appropriate behaviours at office and home. This year, we introduced 29 training programmes based on the identification of training needs.

- Emergency preparedness
- Work at height
- Scaffolding safety
- Electrical safety
- Defensive driving
- Machine guarding

This year, we conducted training sessions for our subject matter experts and members of the task forces to update them on safety topics. The training sessions included a wide range of topics like hazard identification using Job Safety Analysis (JSA), chemical safety, hot work and fire safety, mobile crane safety, role, and responsibilities of Field Contract Administrator (FCA).

Evaluating the effectiveness of the safety training is vital to us. So, to get

a perspective on further improvement of the training, we collect feedback from participants and managers immediately post training. Each training module contains a pre-defined questionnaire to measure its effectiveness. Workers with less than 80% score are supposed to take the safety training again. Training feedback is also taken from the manager or HOD in order to evaluate the need for any further training. The table highlights the training hours for the reporting year.

Category	Unit	Aluminium and mines	Copper	Hindalco (Total)
Training on Safety - Management Staff	Numbers	5,431	467	5,898
	Hours	1,85,504	15,560	2,01,064
Training on Safety - Permanent Workmen	Numbers	12,552	1,023	13,575
	Hours	3,76,409	23,465	3,99,914
Training on Safety - Contract Employees	Numbers	16,203	3,451	19,654
	Hours	8,12,218	3,20,301	1,132,519



Hindalco adopts the hierarchy of control to manage safety risks



# Human Capital



## E-PERMIT IMPLEMENTATION ACROSS HINDALCO

At Hindalco, we involve skill-based manpower to carry out day-to-day manufacturing functions. To ensure there is no deviation from Permit to Work (PTW) procedure, we have introduced an e-permit system. Through this web-based system, it is possible to apply, approve and issue permits. The permits can be raised by authorised personnel or permit applicants (PA) from his handheld device. After physical verification, the Approving Authority sanctions the permit.

The table highlights work-related injuries for the reporting year.

Category	Unit	Aluminium and mines		Copper		Novelis		Hindalco +Novelis (Total)
		Employees	Contractual workers	Employees	Contractual workers	Employees	Contractual workers	
Lost Time Injuries	Number	17	15	2	3	23	12	72
Total recordable injuries	Number	49	38	4	7	88	25	211
Fatal accidents	Number	0	1	0	1	0	1	3
Lost Time Injury Frequency Rate (LTIFR)	Number/ Million hours	0.37	0.22	0.71	0.21	0.73	0.65	0.39
Total Recordable Injury Frequency Rate (TRIFR)	Number/ Million hours	1.06	0.55	1.42	0.48	2.81	1.35	1.16
Total man-hours worked	Hours	4,60,78,868	6,92,55,082	28,15,192	1,43,95,685	3,13,49,199	1,84,35,497	18,23,29,523

During the reporting period, we regret the occurrence of two fatalities for our contractual workers at our India operations and one fatality at our Novelis operations. However, we reported zero fatalities for our employees at India and Novelis operations.

To ensure the safety of all our employees and contractual workers and to work towards a goal of zero fatality and life-threatening diseases, we have formed task forces and sub-committees at all

Hindalco units. The task forces comprise JSA subject matter experts guided by nine technical safety standards, eight administrative standards and eight corporate guidelines. Our two prime focus areas in limiting the number of injuries is Contractor Safety Management (CSM) and Operational Discipline. All Hindalco units follow CSM, and all the manpower is deployed as per CSM procedure. Secondly, operational discipline has been identified as a major focus area for FY2021-22.

As a part of this initiative, all Hindalco units have identified 'in line of fire' activities and have taken measures to eliminate the hazards. At our Apex safety Board meeting chaired by the MD, we discuss all serious unsafe observations made under the serious injury and fatality prevention programme. This programme also allows circulation of safety alerts across all Hindalco units.

## Occupational Health Services

We have adopted a three-pronged approach to safeguard our employees with focus on working conditions, working environment and promotion of workers' health. Based on these areas, our Group Sustainability cell has developed 'Occupational Health Management (OHM)' standard. OHS services are delivered in accordance with this OHM standard. We carry out Qualitative Exposure Assessment (QIEA) by evaluating the quality of the working environment through surveillance at the workplace, according to ILO Convention 161.

To analyse the exact pollutant load to which an individual or a group is exposed to, we carry out Quantitative Exposure assessment (QnEA). QIEA and QnEA are integral tasks of the Hindalco OHS and all mines comply with the recommendations coming from them. Both QIEA and QnEA studies are carried out by certified industrial hygienists and live pollutant samples are taken and analysed by national/international laboratories. Further, medical checks are carried out for individuals or groups based on the pollutant they are exposed to. The findings of the QnEA studies are benchmarked with NIOSH standards and Indian Factories and Boilers regulation standards.

We also conduct pre-employment and routine medical examinations for our permanent and contractual employees such as prescribed by national statute/ international guidelines.

We follow occupational health standards for First Aid and health emergency management, HIV, TB and malaria management. There are medical centres at all our sites with qualified industrial health physicians available to employees at all times. Also, there is a corporate level 'Integrated Health Committee' chaired by Senior leader from the mines cluster and consists of industrial health physicians and subject matter experts.



The committee discusses and implements the best practices at all our units. For the second consecutive year, we did not observe any work-related ill health. We trained 200 hygiene champs to improve hygiene infrastructure at all units. To manage stress in a better way, we are in the process of creating an Occupational Stress Management standard.

We have adopted Occupational Health Risk identification and Management standard. This standard mandates us to reduce the concentration of pollutants at source and reduce the exposure duration. We provide Personal Protective Equipment (PPE) wherever necessary. We strictly follow the hierarchy of Occupational Health Risk Assessment & Management to ensure reduction at source by implementing engineering controls first, then the administrative controls and lastly, we provide PPE where required.

We have a Group level policy in place to avoid discrimination of any form against HIV and TB patients. Hindalco, as a part of Aditya Birla

Group, is a signatory to Safe Water, Sanitation and Hygiene (WASH) pledge movement of World Business Council for Sustainable Development (WBCSD) and all recommendations of WBCSD are implemented in letter and spirit.

## Safety risk assessment

We have comprehensive standards for Safety and Occupational Health Hazard identification and Risk assessment and Management. In FY2021-22, a comprehensive review of risk assessment using Job safety analysis (JSA) was undertaken. JSA is a structured technique which reviews all the activities identified by the respective departments of all units. We have mandated 'no work without risk- assessment' and all work-related activities are reviewed before commencement. All our plants are assessed and audited by third party entities or statutory authorities.

We have Hazard Identification and Risk Assessment (HIRA) subject matter experts at each Hindalco unit, who are deployed after receiving a five-day comprehensive training followed by a

# Human Capital

post training assessment. All activities with risk rating of '8' and above are regulated by implementation of necessary control measures to bring the risk at 'As Low as Reasonably Practical (ALARP)'. Also, to perform this activity, 'Permit to work' recognised by competent authority is mandatory.

To report unsafe activities, conditions, and practices, we have created various platforms like safety committees at each unit, complaint boxes, Behavior Based Safety Observations (BBSO) etc. We encourage our contractual workers to always report any incidents through 'near miss and potential incident card system' or by taking it up with their managers. There are several rewards and recognition schemes for motivating safe behavior and promoting the identification of unsafe conditions and practices. Our workers are rewarded for reporting unsafe activities and behaviours and the safety performance of the unit has a bearing on the annual incentives of all unit employees. We spread awareness on safety related critical matters through the 'safety theme of the month' initiative.



## LEADING INDICATOR INDEX (LII)

At Novelis, we introduced LII to change our safety culture and to allow Safety Management System to focus on proactive safety activities. The idea of LII is based on three metrics namely risk reduction, corrective action focused on hierarchy of controls and leadership engagement. Each Novelis plant is given a score depending on how they perform against each metric. At every unit, a database is maintained tracking activities related to each metric.

The introduction of LII led to multiple benefits including reduction in risks, injuries, and fatalities. Furthermore, LII promoted excellent leadership engagement with corrective and preventive action plans. LII was introduced in FY2021-22 with a target of 95% by the end of year, but Novelis outperformed by 190%, exceeding the initial target.

## THINKSAFE360

Employee safety is our biggest concern, and we take all actions to eliminate the risk of hazards in the workplace. Novelis Europe started an initiative named ThinkSafe360, with an aim of achieving zero accidents or near miss case related to heavy loads and mobile equipment; using systematic risk elimination methods, based on employee exposures at the facilities from the entrances to the exits of the plants. This programme targeted three areas of concern: plant layout and conditions, machine centers, and employee behaviors and risk awareness. Using these three areas of concern and systematically following the material flow throughout the facility, all sites assessed potential hazards where employees could be hit, struck, pinched, or crushed by a coil, ingot, scrap, machine parts, train, forklift, truck, or crane. Based on the risk assessment, site leaders developed solutions to eliminate the hazard or to reduce the risk to an

acceptable level. Web conferences were held every month to share practices, hold accountability and provide updates on the various projects throughout Europe.

Due to the ThinkSafe360 initiative, numerous benefits were realised. Because site layout was considered, several areas were identified where additional barriers needed to be constructed to protect pedestrians. In some situations, full areas were completely redesigned to eliminate employee exposure to mobile equipment. In addition to layouts, sites began implementing anti-collision and proximity detection technology systems on mobile equipment, which uses sensors to provide warnings to pedestrians and operators to prevent accidents. Novelis Europe will continue with ThinkSafe360 initiative for the FY2022-23 since it has resulted in tremendous reduction in risk.

## HOUSE OF SAFETY

We initiated the House of Safety programme in Novelis South America to create a robust EHS management system and incorporate EHS subjects in our daily routines. With an aim of a safe workplace, HOS engages entire manufacturing units, tracks leading KPIs and encourages employees in EHS solutions. An elected EHS committee has weekly meetings discussing KPIs. In our monthly safety meetings, all manufacturing units share their results, present best practices, and recognise employees that contribute to making EHS excel.

The committee consists of employees from different functions which gives a comprehensive approach while addressing safety issues and working towards a safer environment. Having a multifunctional group with different mindsets provides better solutions to drive actions and results with their multi-functional knowledge. Since the initiation of this programme, there have been zero SIFs and DAW.

## ROBOTIC DE-SCALER AND MINI DOZER FOR REFINERY TANKS OVERHAULING

Descaling activity consists of removing heavy scales which fall from the side walls and rake arms of the tank. This activity can result in caustic mud splash on body or injury due to hand-held tool slip, trip and fall. In order to eliminate the risks associated with this activity, we have started a pilot initiative of using an automatic descaling robot using electro hydraulically driven de-bricking machines and mini dozer for safe and remote material handling at Belagavi in a mud washer tank.

The prime objective of this pilot is to reduce manpower deployment and enhance safety by minimising risk of injury due to manual descaling. This pilot activity will also focus on reducing the current turnaround time (TAT) of 14 days, increasing availability of equipment and reducing time spent on maintenance.

## Health and Safety Future Goals

**Short term**  
10% improvement yoy in LTIFR and TRIFR.  
Zero fatalities.

**Medium term**  
Best in manufacturing Industry in LTIFR, TRIFR performance.

**Our Vision**  
Zero  
Harm to all our stakeholders.



At Hindalco, awareness on critical safety related matters is spread through the Safety theme of the month





# Intellectual Capital



## Turning new ideas into possibilities

Aluminium and copper offer endless possibilities for creating new shapes and forms, unlocking the potential of technology. Our R&D efforts are two pronged. We tap internal expertise in product development, manufacturing, design; and we partner with recognised institutions to meet the fast-growing demand for new-age products.

Digital technologies have been a key driver in innovation at Hindalco and we are leveraging the digital transformation of our business and processes to deliver superior products to our customers. Our R&D capabilities have enabled us to enter and succeed in the high-end downstream product segments in a big way.

### Key Highlights

**114**

Patents filed

**320**

Patents granted

**₹716 CR**

Research and Development (R&D) investments

**40**

New products and applications developed

### Contributions to SDGs



### Value Enhancing Growth

<b>SP-2</b>	<b>SP-3</b>	<b>SP-4</b>
Value enhancing growth	Strong ESG Commitment	Portfolio Enrichment

### Interlinkages with Material Topics and Other Capitals

Material Topics	Capitals Connected
R&D innovation and Technology	Financial Capital
	Manufactured Capital
	Natural Capital



### Our Focus Areas

Strengthening R&D for downstream products	New technological solutions
Product quality and performance	Digitalisation



# Intellectual Capital



All of Hindalco's plants are equipped with their own research and development centers and technical cells

beverage can and specialties markets. Our Spokane centre in Washington specialises in molten metal processing. Gottingen center conducts R&D for new products and processes that can be added to our portfolio. At Koblenz and Zhenjiang we have innovation centers for aerospace. We also have centers in Ulsan and Detroit.

## Development of Products

This year we took significant strides on new product development and will continue our efforts in the years to come to expand to other segments. As aluminium and copper are key metals and will be essential in future megatrends, we are exploring solutions and products that can be developed to cater to the market.

For aluminium-related products and processes, our focus is on developing specialty alumina-based products and their application in refractory castable and improving the efficiency of the Bayer's process. We are innovating aluminium-based solutions for coaches and railway wagons, recyclable packaging, and new-generation aluminium-based solutions. In the areas of EV and mobility, we plan to jointly develop aluminium-based solutions for Original Equipment Manufacturers (OEMs). The OEM's commitment to sustainable, lightweight, and high-performance products opens an opportunity for us to develop products in this sector.

We are focusing on developing new downstream products as well as value-added products from copper slag, electrorefining, electrowinning of copper, and mass balance of impurities from copper smelting and refining. We have developed two applications which have been accepted by the customers and two applications are at pilot stage in lab.

that all our labs are technically and analytically sound. In addition to that, all the plants are equipped with their own research and development centres and technical cells.

Our centres encompass the full spectrum of research and development, applied technology, and market-led innovation. At HIC-Belagavi, we conduct R&D related to bauxite, specialty alumina & hydrate and Bayer's process. At Taloja, we have HIC Tribology and HIC Semi-fab. We conduct R&D related to oil and lube at HIC Tribology, and aluminium-related metallurgical applications at HIC Semi-fab. HIC-Dahej specialises in R&D related to copper smelting, copper refining, byproduct applications and copper-related services.

Novelis is working on expanding the portfolio by introducing new technologies. It has eight research centers and four Customer Solution Centers (CSC) across the globe. At the Georgia, Shanghai and Sierre locations, we conduct innovations for applications of aluminium in the automotive,

## Innovation at Hindalco

We foster a culture of innovation throughout the development cycle of our products and processes. Our focus is to strengthen the R&D capacity to develop downstream products and bring new technological solutions as we contribute toward India's Net-Zero Goal.

With support of a strong R&D team, we filed 114 patents in FY2021-22 and 320 patents were granted including patents applied in previous years. We invested ₹716 Crore in the R&D portfolio in FY2021-22.

We have four Hindalco Innovation Centers (HIC) at Belagavi, Taloja and Dahej with world-class R&D facilities. Our HICs are recognised by the Department of Scientific & Industrial Research (DSIR), Government of India. Quality assurance is important for us, and all our labs are accredited by the National Accreditation Board for Testing and Calibration Laboratories (NABL) with standard 17025:2005. The accreditation assures

At Novelis, we are continuously focusing on reduction of energy, waste, water as well as carbon footprint. On the technological front, we have developed BPA<sub>n</sub>i coating for can end sheets, coating products and coffee capsules made with high recycled-aluminium content sheets.

HIC	Products and applications developed and accepted by customers	New products and applications developed in lab
HIC Belagavi	9	7
HIC Tribology	2	5
HIC Semi-fab	3	5
HIC Dahej	2	2



Novelis has eight research centers and four customer centers across the globe

## Development of Hydrate to Produce EN45545/HL Composite for Railway Metro (Equivalent to ON904)

Railway vehicles are categorised as per the fire-safety Hazard Level (HL) associated with their operation and design. EN45545/HL is the European standard for fire safety with HL1, HL2, and HL3 as hazard levels, where HL1 is the lowest and HL3 is the highest. We have developed a special hydrate for EN45545/HL-3 composite for polymeric composite products. Our hydrate will be used as filler in the composite materials

of railways and metros and will make the coaches safer to travel. The Total Global sales potential is 130 KTPA and Indian Potential is 3 KTPA. Our product is commercialised as grade name HLV213 and is approved in Europe.

## Development of Low Soda Submicron reactive alumina

Reactive alumina comprises fine particles with high thermal reactivity and low water absorption capacity. We have developed reactive alumina with low soda content with improved high-temperature mechanical properties.

It is produced through extensive milling by using specialised grinding aid to avoid agglomeration. Due to its properties, it is used in fine and advanced electro-ceramics and castable refractories. The plant trials of the product are completed, and the commercialisation of the product is in progress.



# Intellectual Capital

## Development of Precipitated Superfine Hydrate



We have developed a precipitated superfine hydrate to replace the halogen filler in fire retardants. Our product can bear temperature and has better flame resistance compared to conventional fillers and is developed through a precipitation process. We have completed the plant trials and the patent has been filed for the process. We will supply the hydrate to manufacturers of polymeric cable, composite silicone insulators and fire retardants. We plan to expand the capacity from 30 KTPA to 60 KTPA in the future.

## Development of bimodal reactive alumina



We have developed bimodal reactive alumina for self-flow refractory castable. We developed this product by controlling milling of two feeds and by using grinding aid. We are also testing this value-added product in low cement castable composition to check the flowability and the strength. The process is developed at the lab and tested at the plant scale. We have also started commercialisation of the products.

### DEVELOPMENT OF EPOXY BASE COAT FOR AC FINS AT TALOJA

AC fin stocks are used in domestic and industrial Heating, Ventilation and Air conditioning (HVAC) applications, and have stringent performance requirements of strength and formability. Epoxy coats are applied to the fins for protection and durability. Under Govt. of India's PLI scheme, at Taloja, we are planning to put an AC fin coating line.

As coating material is one of the major contributors to the cost of manufacturing coated fins, we have developed an in-house epoxy coat for AC fins. With this development, we expect a 30% cost reduction for coated AC fins.

### ALUMINIUM E-BIKE PROTOTYPE

A large segment of urban last mile delivery service segment is being catered to by the e-bicycle segment. Aluminium frames are a preferred choice for these bikes and the market is currently reliant on imports to meet the demands.

Considering this as an opportunity, our HIC Semi-fab has designed and assembled an e-bicycle using aluminium frame manufactured by Hindalco Extrusions. We are also exploring preliminary CAD tools for frame designs and automating frame performance feasibility analysis under various load cases.

### BB590- ALUMINIUM BUSBAR ALLOY

We have developed a new patented aluminium busbar alloy BB590 in association with Renukoot FRP for application in two-wheeler electric vehicles. BB590 is characterised by excellent formability and electrical conductivity. This product has best-in-class current carrying capacity and corrosion resistance. It also significantly improves electrical and thermal conductivity making it ideal for electrical applications. Actual application has shown a consistent 25% increase in wire pull-off load in assembly, thereby improving the reliability of the battery pack. We have tested the alloy successfully passed resistivity, corrosion and welding tests. We are currently manufacturing Busbar prototypes for testing at battery pack level.

## Delivering High Quality

Aluminium has become the metal of choice for manufacturers across the globe. It is being used in a myriad of applications with expectations of different performance attributes. Hindalco is an industry leader, well known for delivering high-quality products with strict adherence to the customer's requirements and international quality standards.

Our R&D centres are constantly working to enhance the value provided to the customers through improvements in product performance and quality. To improve the process and ensure quality delivery of products, we conduct Life Cycle Assessment (LCA) at all our plants. We identify the potential impacts of products and services during their entire lifespan and take measures to reduce the impacts.

In FY2021-22, we initiated a refresh of the LCA for products from five of our downstream plants, out of which we have completed the assessment for Mouda.

### QUALITY IMPROVEMENT OF LIBERATOR CATHODE AT COPPER REFINERIES

At the Birla copper, the electrolyser collects about 120-160 m<sup>3</sup>/day of electrolyte to control the concentration of copper and impurities (As, Bi, Sb) in the electrolyte. Copper from the solution is recovered in the liberator section by an electrowinning process using a Pb-Ca-Sn alloy as the anode. The reprocessing or recycling of liberated cakes is a challenge due to high levels of contamination. We have developed two processes to reduce the impurities in the liberator cathode and the inventory of copper. Before

electrowinning, the electrolyte must go through flocculation and centrifugation. At the same time, the quality of the existing liberator cathode inventory can be improved by grinding and screening. In this case, the impurities are separated into finer fractions and can be recycled.

With the application of the two processes, we observed improvement in the quality of the liberator cathode with a 90% reduction of arsenic and reduction in copper inventory.

### ALLOY QUALITY IMPROVEMENT- DURANIUM™ BETA

In FY2020-21, we developed and patented a new alloy, Duranium™. This alloy provides superior strength and a better surface finish. In FY2021-22, we launched window systems made with this alloy.

This year we have developed a beta version of this alloy which seeks to enhance mechanical properties by approximately 20% as compared to the first-generation Duranium™ alloy which itself is a superior product compared to the competition.



# Intellectual Capital

## COLD CLADDING TECHNOLOGY

The cladding technology in the aluminium industry currently has inherent drawbacks leading to poor recovery, high cost and inconsistent quality. After initial lab development in collaboration with IIT Madras, we conducted pilot trials for one-side clad in FY2020-21. These trials demonstrated extremely good metallurgical bond between the core and liner alloy, and lab brazing simulations gave promising results. We also attempted two side cladding in these trials. Material produced from these trials was subjected to customer evaluation. We carried brazing

trials in a production furnace and performance evaluation was done by the customers.

Clad layer characterisation showed improved thickness percentage and uniform Silicon particle distribution with the novel method. The customer feedback that we received has been encouraging, and commercial qualification trials have been requested. We have completed the basic engineering of the technology and specifications have been agreed with the customer for commercial trials in FY2022-23.

and Technology Centre. For aluminium-based rechargeable battery and MELD on solid-state additive manufacturing technology, we have collaborated with Graphene Manufacturing Group. For the development of coated current collectors, collaboration with Birla Carbon and Novelis is underway.

We are also developing a solution for utilising processed copper slag in cement industry and are trying to implement an arsenic recovery process from the liberator cake waste of our copper plant. We are working with IIT Gandhinagar for extended process development for Ag/Au recovery from primary dore-slag from Precious Metal Recovery (PMR) plant.

We are partnering with Manush Labs, a startup incubator platform, to find innovative startups for finding solutions to alternative non-plastic packaging and Flue Gas De-sulphurisation (FGD) waste utilisation. We are working with IIT Bombay on a Bauxite residue neutralisation project, using flue gas from a power plant and polymeric bricks from waste Bauxite residue and fly ash, the latter project nearly at commercial stage.

## Digital Hindalco

We have embarked on a journey of digital transformation and are continuously working to create best-in-class Information Technology (IT) infrastructure with robust cybersecurity. We have developed an IT policy to protect data and improve digital security. In addition, 90% of our IT infrastructure is certified with ISO 27001 Information Security Management System. We test our IT infrastructure twice a year for any potential cyberattacks and conduct external verification to identify the cyber threats and possible impacts on business.

We have a defense-in-depth strategy, which includes access on a need basis, 24x7 Security Operation Centre (SOC) to detect anomalous activity and incident threats, with Incident Review (IR) system and security controls at

different levels. We have introduced advanced technologies like Endpoint Detection Response (EDR), Secure Web Gateway and Network Access Control to further safeguard the infrastructure from threats. We have made updates to the existing Security Information and Event Management (SIEM) system, which identifies the patterns that could indicate cyberattacks, including other technologies like Security Orchestration, Automation, and Response (SOAR). In addition, we are focussing on introducing a Web Application Firewall (WAF) with Protocol Analysis Module as an engine, to block the users who don't comply with our firewall policy.

We keep our employees informed and updated about information security and cyber security through e-trainings and frequent communications. We conduct an annual information security week to increase awareness on digital security and cyber security. We have also developed a capability development programme, DISHA (Digital Shiksha), to upskill the workforce on the Internet of Things (IoT), Analytics, Augmented Reality (AR), asset maintenance, and other digital technologies. We educate all the newly joined employees about information security at the orientation programme. In the event of suspicious activity, the employees can register a complaint at the intranet portal, and then further actions are taken.

Our Directors and the executive committee members are involved in the decision-making related to information technology and cyber security. The Risk Management Committee looks after our cyber security strategy. Our Chief Information Security Officer (CISO) oversees the preparedness against cyber-attacks and ensures appropriate action is taken to safeguard company assets. As a result, we received no complaints regarding loss of data, breaches, and thefts, and the entire system was protected from cyber-attacks in FY2021-22.

## TRACK AND TRACE

To track and trace our shipments sent by road, railways, and sea, we have adopted end-to-end digitalisation using IoT. Our domestic shipments are sent by road and railways and international by sea. To keep a bird's eye view over several outbound shipments, we track the shipments sent by road transport by GPS powered by digital dashboard. This enables us to get complete visibility and ensures security of the shipment. In case of emergency situations, the system notifies the drivers in the locality for help and also lists out nearby police stations to call for assistance. Through this system,

we can also predict delays and plan for mitigation actions.

We use the Indian railway's database for tracking shipments sent by rail. We track time live status, estimate the delay time, if any, and plan for the unloading of the shipments using data from this system.

The shipments that we send by sea are tracked by a third-party integrated platform which helps us keep an eye on our shipments, any potential stoppages and plan for quick delivery. We also detail out the mitigation actions for anticipated delays in the future.

## BLOCKCHAIN SUSTAINABILITY SYSTEM FOR WASTE MANAGEMENT

Blockchain system is ideal for waste management as it stores data in blocks, provides a transparent and secure records ensuring that no one can tamper those records. At Hirakud, we installed a blockchain sustainability system for waste management to efficiently track waste from generation to end-of-life cycle transparently which aligns to UN-SDG for quantification into sustainability

metrics. The platform also enables us to authenticate certification for waste processing from the vendors, ensuring that the waste is actually being processed and does not get disposed unethically in the value chain. After the successful application of the technology at Hirakud, we also plan to implement this blockchain technology solution at our other plants.

## Associations for Innovation

Hindalco's strong association with industry-leading technology providers and research institutions has enabled us to deliver high quality products and resolve complex problems across our operations.

Our collaborative research with Aditya Birla Science and Technology Center (ABSTC) continues to deliver benefits in various technology areas. We developed a new in-house design for 400+ ka cell

technology for stage-wise amperage increase. We have also developed Novel process flow sheets for production of 99.99% high purity alumina. With these innovations we have filed three patents.

We partnered with IIT Bombay, IIT Madras, Fraunhofer Institute, and Brandenburgische TU, Germany for projects on additive manufacturing of aluminium. The project worth is approximately €5,00,000 (₹41.2 Million) and is funded by Indo-German Science



Hindalco leverages its industry connect to find unique solutions to complex problems





# Natural Capital

## Conserving, Preserving and Restoring

In alignment with our strategic priority for strong ESG Commitment, we were able to position ourselves as an industry leader in aluminium in the S&P Global Dow Jones Sustainability Index Corporate Sustainability Assessment 2021, for the second consecutive year. We believe we can accelerate value creation by catering to society's increasing demand for sustainable solutions, which will benefit our Company, stakeholders and communities.

We see the need and urgency to go beyond our limits and drive a positive change through our environmental endeavours. We bolster our natural capital in alignment with our commitment to the UN Decade on 'Ecosystem Restoration'. Our key focus areas have been defined to contribute to prevent, halt and restore, the impacts that we have on the ecosystem and bring about a positive change.

### Key Highlights

**100%**

Increase of renewable energy installed capacity from FY2020-21

**18.5%**

Reduction in specific GHG emissions for aluminium from base year FY2011-12

**18%**

Reduction in specific energy consumption for aluminium from base year FY2011-12

**86%**

Waste utilisation with 6 basis points increase from FY2020-21

### Contributions to SDGs



### Value enhancing growth

**SP-3**

Strong ESG Commitment

### Interlinkages with Material Topics and Other Capitals

#### Material Topics

Water Management

Compliance Management

Air Emissions

Waste and Hazardous Materials Management

Energy and GHG Emissions Management

#### Capitals Connected

Financial Capital

Manufactured Capital

Intellectual capital

Human Capital

Social & Relationship Capital



### Our Focus Areas

Net Carbon Neutrality	Zero Waste to Landfill	Emphasis on recycled content and Circular Economy
Water positivity and Zero Liquid Discharge (ZLD)	Sustainable Mining of coal and bauxite	Biodiversity Conservation with No Net Loss

# Natural Capital

## Key Highlights:

**114%**

Ash utilisation with 24 basis points increase from FY 2020-21

**10%**

YoY increase in greenbelt

**10.7 MN m<sup>3</sup>**

Within and beyond fence rainwater collection storage capacity

**9%**

Reduction in specific freshwater consumption for aluminium from base year FY2018-19

## Environment Management

Environment Governance at Hindalco starts with the Board of Directors, with the Risk Management & ESG committee providing strategic inputs. Our Apex sustainability committee, having representation from two Executive Directors, tracks implementation of sustainability initiatives in the organisation through monthly performance reviews. We have instated task forces for each material work area to implement initiatives as per the direction of the governing bodies.

We also conduct Environmental Impact Assessment (EIA) for our new operations as a regulatory requirement, as per applicable law. We continually strive to improve our environmental performance by integrating sound environmental systems and practices. We have formulated an Environment Policy and Sustainability Policy to ensure our compliance. During the reporting period, we faced two incidents of environmental non-compliance. However, no penalty was paid, and as a mitigation strategy, corrective actions have been taken. Further, all our operations are running with necessary permits and clearances.

We have undertaken TCFD based assessment to identify the climate related risks and opportunities to align our business strategy to the global climate transition, and the details of the same can be found on our website with our detailed TCFD report. We have ISO 14001:2015 certification for all sites of Hindalco. In FY2021-22, we spent ₹413.9 Crore in Capex and ₹601.1 Crore in revenue expenditure on Environment management. At Novelis, we spent \$16 Million (₹121.5 Crore) in Capex and \$2 Million (₹15.2 Crore) in operational expenditure on environment management.

### Towards Decarbonisation

With global temperatures rising and climate impacts becoming more evident, there is an urgency to act. Acknowledging the energy-intensive nature of our business, we at Hindalco believe that our decarbonisation strategy will enable us to contribute towards the global commitment of limiting global warming to 1.5 degrees Celsius. We have started our journey towards Net Carbon Neutrality and aim to achieve it by 2050. In line with this target, we aim to reduce the specific energy consumption and specific GHG emissions by 25% by 2025

from the base year of FY2011-12. For our Novelis operations, we plan to reduce the carbon footprint by 30% by 2026 and reduce energy intensity by 10% by 2026.

The path towards decarbonisation has opened a diverse pool of opportunities for us. The levers on which we are relying for decarbonisation are energy mix and energy efficiency, increasing focus on value-added products and product stewardship. We are tapping opportunities for increasing renewable energy generation, improving energy efficiency through innovative projects and exploring modern technologies like green hydrogen, low carbon fuels, and Carbon Capture Utilisation and Storage (CCUS). We are expanding downstream manufacturing capacity to develop value-added products that utilise less energy and have much less impact over their lifecycle. We are also accelerating the development of low-carbon products to cater to upcoming markets.



## Internal Carbon Pricing

Internal Carbon Pricing (ICP) is an effective tool for managing carbon risk and opportunities, and to enable more carbon efficient projects to get approved through the investment decision process. We have adopted the ICP mechanism to monitor the cost of carbon. This initiative will help us to prepare for upcoming regulations, Emission Trading Schemes (ETS), Carbon Tax and taking investment decisions related to low carbon growth initiatives.

We initiated a solar project at Bagru with a capacity of 500 kWp with 390 kWh of battery storage. Before the initiation of the project, we used the ICP tool to calculate the Internal Rate of Return (IRR) and Net Present Value (NPV). With the ICP tool, our IRR and NPV increased, and the project got a boost in return metrics which made approvals easier. The ICP tool considers the direct returns from the project, hidden savings/cost from fuel, electricity, and hidden savings/costs of carbon.

## Energy Consumption

It has been a fruitful year for us with the production and sales figures soaring at an all-time high. The total energy consumption for Hindalco and Novelis amounted to 310.49 Million GJ in FY2021-22.

Our Hindalco operations consumed 270.8 Million GJ of energy in FY2021-22. Out of the total energy consumption, 96% was by our aluminium and mines operations and 4% by our copper operations. We purchased 0.13 Million GJ of renewable energy and around 8.03 Lakh Non-solar REC & 0.25 Lakh Solar REC in FY2021-22. Six of our sites are certified with ISO 50001 i.e. Energy and Carbon Technical standard.

We took several initiatives to increase the share of renewable energy at Hindalco. In FY2021-22, we added 51 MW of renewable energy capacity, taking the total installed capacity to 100 MW. We are also in the process of executing 24 MW clean energy projects and finalising another 55 MW of projects. Our target is to expand the renewable energy capacity to 300 MW by 2025, including 100 MW with storage. We are also planning to take up projects on a large scale through third-party round-the-clock renewable power sourcing, to the tune of 100-300 MW in the near future.

Our Novelis operations consumed 39.69 Million GJ of energy. The increased energy consumption was due to the expansion of our global operations. To reduce the energy consumption from conventional fuels, we are in the process of preparing a roadmap for renewable energy consumption. We have also carried out site assessment for Photovoltaic (PV) panel installation. We plan to implement two new renewable projects in the upcoming future.

## Renewable Energy Consumption

(Million GJ)

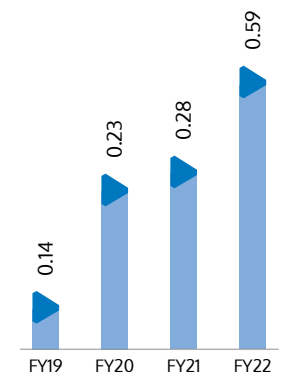

Year	(Million GJ)			
	Renewable Energy	Non – Renewable Energy	Total	
FY2018-19	Hindalco	0.14	276.64	276.78
	Novelis	-	30.27	30.27
	<b>Total</b>	<b>0.14</b>	<b>306.91</b>	<b>307.05</b>
FY2019-20	Hindalco	0.23	272.73	272.96
	Novelis	-	30.51	30.51
	<b>Total</b>	<b>0.23</b>	<b>303.23</b>	<b>303.47</b>
FY2020-21	Hindalco	0.28	254.90	255.18
	Novelis	-	37.28	37.28
	<b>Total</b>	<b>0.28</b>	<b>292.18</b>	<b>292.46</b>
FY2021-22	Hindalco	0.59	270.21	270.80
	Novelis	-	39.69	39.69
	<b>Total</b>	<b>0.59</b>	<b>309.90</b>	<b>310.49</b>





Solar plant at Aditya

Energy Type (Million GJ)						
Year		Fossil Fuels	Electricity Purchased	Renewable Energy source	Steam/Heating/Cooling and Other Energy (Non-Renewable) Purchased	Total Non-Renewable Energy (Electricity and Heating & Cooling) Sold
FY2019-20	Hindalco	273.79	3.03	0.23	0.002	4.1
	Novelis	21.55	8.69	0	0.27	-
	<b>Total</b>	<b>295.34</b>	<b>11.72</b>	<b>0.23</b>	<b>0.27</b>	<b>4.1</b>
FY2020-21	Hindalco	255.65	1.9	0.28	-	2.7
	Novelis	25.64	11.42	-	0.21	-
	<b>Total</b>	<b>281.29</b>	<b>13.32</b>	<b>0.28</b>	<b>0.21</b>	<b>2.7</b>
FY2021-22	Hindalco	269.72	2.68	0.59	0.01	2.2
	Novelis	29.34	10.05	-	0.3	-
	<b>Total</b>	<b>299.06</b>	<b>12.73</b>	<b>0.59</b>	<b>0.31</b>	<b>2.2</b>

**Energy Intensity**

We measure specific energy consumption for our aluminium and copper operations. For aluminium, our specific energy consumption is the energy consumed per tonne of primary aluminium across our smelter, alumina refinery and anode plant operations. For copper, our specific energy consumption is the energy consumed in copper operations per tonne of copper cathode produced. Our efforts to increase the operational efficiency in aluminium and copper verticals have resulted in reduced specific intensity for aluminium and copper.

**Energy Intensity Aluminium (GJ/MT)**

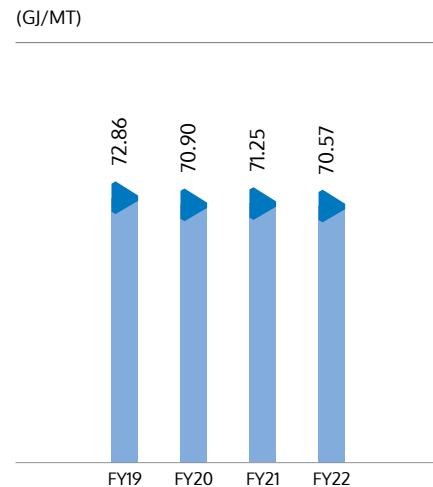

**Energy Intensity Copper (GJ/MT)**

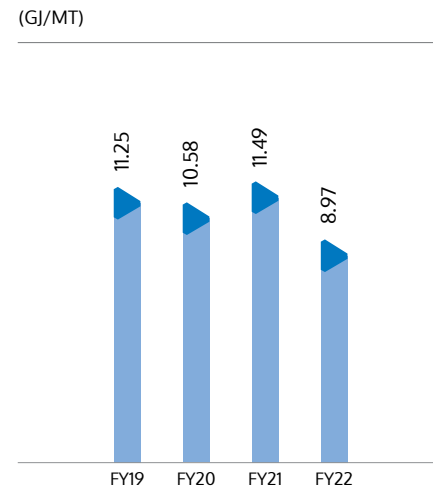

**Emission Management**

Reducing energy consumption is important for reducing GHG emissions, but we aim to go beyond. We have initiated projects for transition to low emission fuels and are working with the public sector to ensure availability of such fuels at the sites. We are planning to operate a portion of our smelter operations at Aditya using LNG in place of coal at the power plant.

To strengthen the monitoring of our emissions, we have started monitoring emissions for mines along with the aluminium and copper manufacturing processes. Along with Scope 1 and Scope 2, we also have started monitoring Scope 3 emissions for our aluminium operations. Scope 3 emissions are more material to our downstream operations. In FY2021-22, total GHG emissions at Hindalco were at 27.14 Million tCO<sub>2</sub>e for Scope 1 and Scope 2. The rise in our GHG emissions is due to the expansion of the Utkal alumina refinery. We monitored Scope 3 emissions for three downstream plants in five categories which were found to be material. These include purchased goods and services, fuel and energy-related activity, upstream transportation and distribution, waste generation and transportation and downstream transportation and distribution.

In FY2021-22, the GHG emissions for our Novelis operations were at 2.3 Million tCO<sub>2</sub>e for Scope 1 and 2 and 17.92 Million tCO<sub>2</sub>e for Scope 3. The rise in emissions is due to the expansion of activities at Novelis. Though, with the use of recycled aluminium, we avoided 16.7 Million tCO<sub>2</sub>e emissions in FY2021-22.

Together at Hindalco and Novelis, our GHG emissions amounted to 29.47 Million tCO<sub>2</sub>e for Scope 1 and Scope 2 and 17.92 Million tCO<sub>2</sub>e for Scope 3.



Pear plantation at Samri mines

Emissions - Hindalco (Million tCO <sub>2</sub> e)					
Year	Scope 1		Scope 2		Total (Scope 1 + 2)
	Aluminium + Mines	Copper	Aluminium + Mines	Copper	
FY2018-19	26.07	1.15	0.51	0.04	27.77
FY2019-20	25.94	1	0.58	0.11	27.63
FY2020-21	24.33	0.83	0.39	0.04	25.59
FY2021-22	25.76	0.79	0.45	0.14	27.14

Emissions - Novelis (Million tCO <sub>2</sub> e)				
Year	Scope 1	Scope 2	Total (Scope 1 + 2)	Scope 3
FY2019-20	1.38	1.12	2.5	1.85
FY2020-21	1.48	1.12	2.60	11.82
FY2021-22	1.39	0.91	2.3	17.92*

\*Novelis has started tracking Scope 3 emissions of several new categories resulting in the increase

**GHG Emissions - Aluminum + Mines (Million tCO<sub>2</sub>e)**      **GHG Emissions - Copper (Million tCO<sub>2</sub>e)**

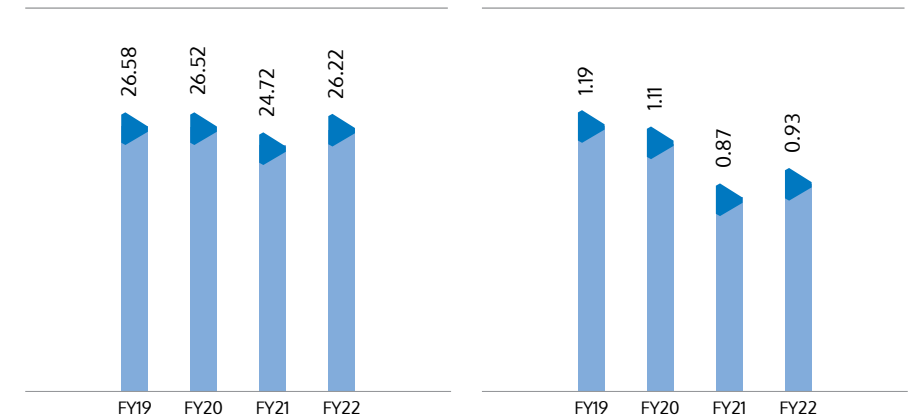



# Natural Capital



## GHG Emission Intensity

We report GHG emission intensity for our aluminium and copper operations including downstream. Our GHG emission intensity can be seen decreasing due to various efficiency measures taken at our plants.

The GHG emission intensity at Novelis amounted to 5.34 tCO<sub>2</sub>/MT, which is higher compared to FY2020-21. We are taking measures to reduce the emission intensity as we expand.

GHG emission intensity - Aluminium (tCO<sub>2</sub>/MT)

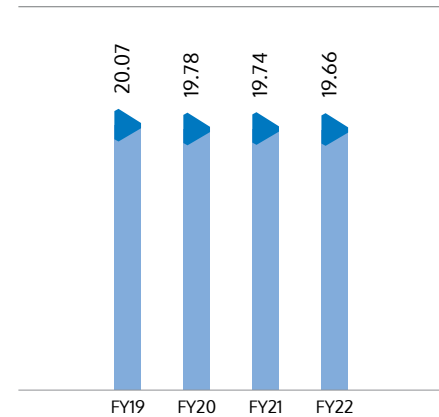

GHG emission intensity - Copper (tCO<sub>2</sub>/MT)

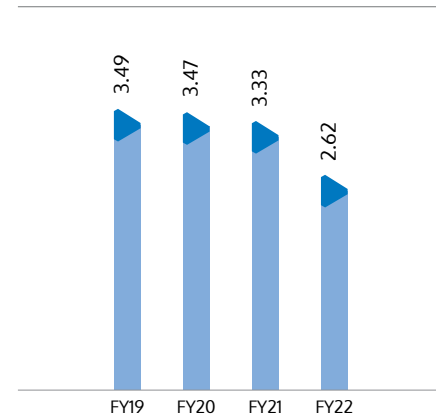

GHG emission intensity - Novelis (tCO<sub>2</sub>/MT)

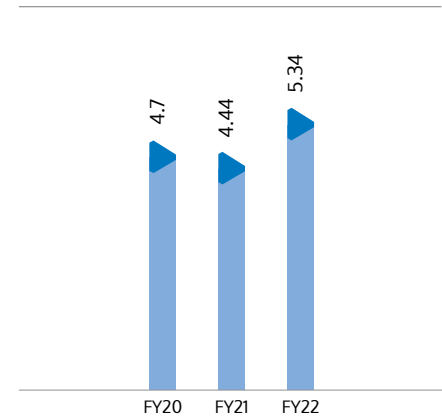

## Stack Emissions

Our non-GHG air emissions occur because of burning of fuel and in the production process itself. Our aluminium smelting process contributes to fluoride emissions while the burning of fossil fuels contributes to Oxides of Sulphur (Sox), Oxides of Nitrogen (NOx) and Particulate Matter (PM). Hence, we monitor these pollutants regularly for processes and fuel consumption as part of our operations. We track emissions through the Continuous Emission Monitoring System (CEMS) and by NABL accredited third parties on a regular basis.

Pollutants	Air Emissions ('000 MT)							
	Hindalco- Aluminium			Hindalco- Copper			Novelis	Hindalco + Novelis
	Process	Fuel	Total	Process	Fuel	Total	Total	Total
Oxides of Sulphur (Sox)	6.43	70.23	76.66	0.48	0.38	0.85	0.17	77.68
Oxides of Nitrogen (Nox)	4.25	28.65	32.90	0.00	0.12	0.12	2.23	35.25
Total Particulate Matter (PM)	2.21	7.10	9.31	0.09	0.12	0.22	0.73	10.26
Fluoride	0.05	0.00	0.05	0.00	0.00	0.00	0.00	0.05



Novelis' Ulsan plant in South Korea

We carry out ambient air quality assessments as fugitive emissions are material in the upstream plants. We calculate Air Quality Index (AQI) and ensure that the index stays within healthy limits so there is minimum impact on the workforce and the communities at large.

We are taking up several projects to minimise emissions from our operations. We are installing pilot Flue Gas Desulphurisation (FGD) units at Mahan, Aditya, and Renuagar. For the first time in India, Mahan and Aditya, will use semi-dry technology from Black and Veatch which consumes less water.

At Renuagar we will use catalyst-based technology from WL Gore, US, which will be the first large-scale implementation in the world. We are also finalising the pilot unit for Utkal. We are deploying automatic lime feeding system for lime dosing at Hirakud and Muri power plants. These projects have a committed cashflow of over ₹400 Crore, and we are conceptualising other projects worth ₹2,500 Crore for the cause.

At Ulsan Aluminium plant of Novelis, we have Regenerative Thermal Oxidizers (RTOs) to reduce Total Hydrocarbon (THC) emissions. Since the installation, the THC emissions have reduced to

non-detectable levels. We also have Selective Catalytic Reduction (SCR) at Ulsan Aluminum plant to reduce NOx (nitrogen oxide) emissions. Our NOx emissions have reduced from an average of 157 ppm prior to the installation of SCR, to an average of 39 ppm since the installation of SCR.



# Natural Capital

## MEASURES TO REDUCE EMISSIONS AT BIRLA COPPER

At Birla copper, we have a captive thermal power plant (CPP). To store the different types of coal for the power plant, we have a coal yard with 1 Lakh MT of capacity. We consume 30,000 MT of imported coal every month at a gross calorific value of 5,500 kcal/kg. The day-to-day handling of coal leads to fugitive dust emissions. To tackle fugitive emissions and improve the air quality, we have taken various initiatives at the coal yard.

We have installed windscreen of approximately 1,000 metres in the

periphery of the coal yard to contain the dust emissions from spreading. We have installed a water tank to store cooling tower blowdown water, having high turbidity. We reuse this water in the sprinkler system, where we have installed sprinklers with 34 nozzles in the periphery of coal yard and conveyor. To reduce the emissions generated while unloading the coal we have also installed a central sprinkler system with 78 nozzles. Two anti-smog guns are in place to spray water and help the dust particles to settle.

At the thermal power plant, a crusher house is the place where the coal is crushed into a particular size. The crusher house is one of the sources of high fugitive dust emissions, which is why we have installed screens around the house to reduce the emissions. We have also installed an automated lime feeding system to control SOx coming out of the CPP stack.



## Perfluorocarbon (PFC) Emissions

PFC emissions represent PFC kg CO<sub>2</sub> eq per tonne of aluminium produced. Due to the technological challenges in smelter potlines, we observed higher PFC generation. To reduce the PFC emissions, we have taken several initiatives on better process control. We are also collaborating with Aditya Birla Science and Technology Company (ABSTC) for the reduction of Anode Effect Frequency (AEF) by changing the process control logic and implementing a programmable logic controller.

## Direct PFC emissions (kg PFC / MT)

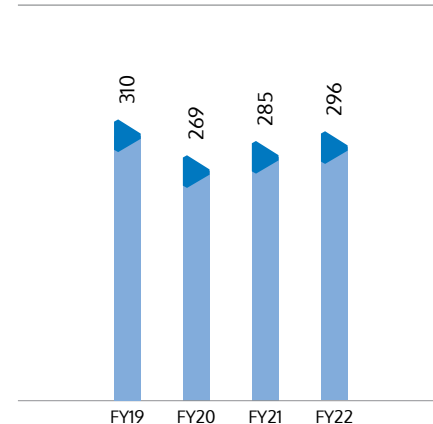

## Ozone Depleting Substances (ODS)

We contributed 0.28 kg of CFC-11 eq ODS during FY2021-22 which is slightly higher than FY2020-21. The major contributor to this was the replenishment of fire retardants and refilling of gases in Air Conditioning systems.

## Ozone Depleting Substances (kg of CFC-11 eq)

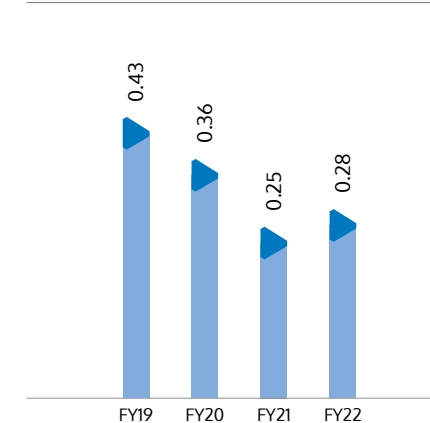

## Initiatives for Energy and Emission Reduction

In FY2021-22, we at Hindalco took 144 initiatives across our sites which resulted in saving a total of 28,89,926.45 GJ of energy and 5,43,327.38 tCO<sub>2</sub>e of emissions.

Our capital expenditure for these projects account for ₹259.5 Crore which resulted in a cost-saving of ₹146.75 Crore. At our Novelis operations, we took 26 new projects with a capital expenditure of \$5.9 Million USD (₹44.78 Crore) which resulted in energy saving of 211.75 GJ and emission saving of 12.36 tCO<sub>2</sub>e. It also resulted in saving \$3.1 Million (₹23.53 Crore)

## Total Projects taken at Hindalco and Novelis- 170

28,90,138.20 GJ Energy Saved	5,43,339.74 tCO <sub>2</sub> e Emissions Saved	₹170.28 Crore Cost Saving
---------------------------------	---	------------------------------

## Perform, Achieve and Trade (PAT)

During FY2021-22, Hindalco received 1,91,171 ESCerts (Energy Saving Certificates) for surpassing target reduction of PAT Cycle-2 (Assessment year - FY2018-19) in which seven units including Utkal Alumina were involved. In this cycle, a net Energy Saving of 0.39 Million TOE (MT of oil equivalent) and an overall reduction of 8.9% was achieved against a target of 4.7%. Hirkud unit had fallen short of the target in Cycle-1 primarily due to plant disruption caused by the flood, while surpassed target in Cycle-2. While Belagavi unit fell short of the target in Cycle-2, actions have been

initiated to meet the target in next cycle (assessment year FY25).

Aditya Aluminium unit was included in PAT Cycle-3 (based on its year of commissioning) and for which M&V (monitoring and verification) audit was under taken in FY21. This unit has also surpassed its target and the audit report is currently with BEE for final approval. The next applicable cycle is Cycle-7, for which targets have been announced and assessment year is FY25.

Designated Consumers	Cycle I	Cycle II	Cycle III	Cycle VII
Renukoot	■			
Hirkud	■			
Muri				■
Belagavi	■			
Taloja	■			
Mahan		■		
Utkal		■		
Aditya			■	

■ Included in PAT cycle



Novelis' recycling plant in Nachterstedt, Germany

# Natural Capital

## ELECTRIC FORKLIFTS AT MAHAN

At our Mahan plant, we produce more than 360+ kt of metal every year which is then converted into various products in the cast house. At the cast house, we produce more than 1,000 MT of molten metal every day. To process the material at various stages, we use

58 different vehicles. These vehicles are a major source of consumption of non-renewable fossil fuels like diesel. Every year, these vehicles consume diesel worth ₹5 Crore and contribute to 1,955 MT of CO<sub>2</sub> emissions. To solve this problem, we introduced electric

forklifts which are easy-to-use, have high capacity and stability, and are low-maintenance vehicles. With the introduction of these electric forklifts, we had an annual cost saving of ₹3 Lakh and 19.5 MT less CO<sub>2</sub> emission.



## ENERGY EFFICIENCY MEASURES AT CAPTIVE POWER PLANT (CPP) CRITICAL AREA, MAHAN

Due to the settling of coal ash and temperature change in the CPP control area at Mahan, the conventional lighting system gets damaged frequently. The frequent damage affected the lux (Luminous intensity) level at the plant. We decided to replace the conventional lighting with LED to maintain the lux level and reduce the emission footprint. With the replacement, we obtained a desired level of lux. In FY2021-22, CPP area had the lowest auxiliary power consumption which resulted in saving 9,89,124 kWh of power and a cost saving of ₹29.5 Lakh.



## ENERGY EFFICIENT PROCESS FOR COPPER ROD PRODUCTION

At the Continuous Cast Copper Rod (CCR) Plant at Birla Dahej, there is a shaft furnace where the solid copper cathode is converted into molten copper. We use Liquefied Natural Gas (LNG) as a source of energy for

the copper cathode melting. The shaft furnace has 19 gas-fired burners divided in Row-A, Row-B and Row-C to melt the copper cathode. The molten copper metal is then converted into a continuous solidified cast bar,

which undergoes rolling process and converts the cast bar into final finished rod of different sizes. To reduce the LNG consumption in furnaces and increase productivity, we adopted a methodology as follows.

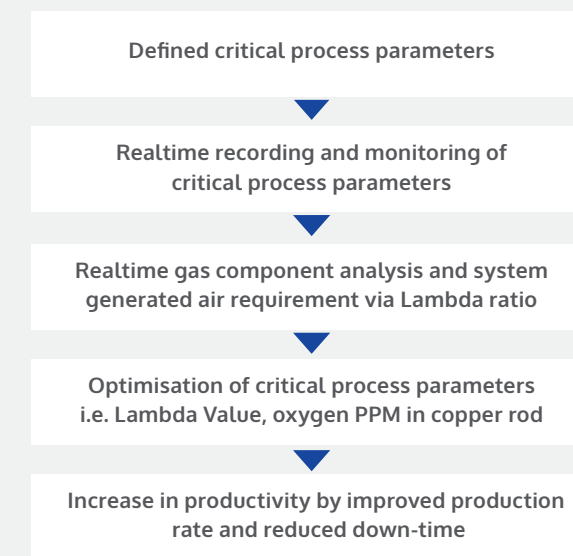

With this initiative, we reduced the LNG consumption by 6.4% from Planning and Budgeting (P&B) target of 39 SCM/MT to 36.52 SCM/MT in FY2021-22. This resulted in a total cost saving of ₹1.46 Crore from P&B cost.

## ENERGY SAVING USING COPPER INSERT COLLECTOR BARS IN POTLINE

With the aim to reduce carbon footprint and to improve pot cell performance, Aditya Aluminum collaborated with ABSTC and initiated a project of low energy lining in the copper insert collector bar.

As copper is more conductive than mild steel, we changed the collector bar design and material of construction. With the use of copper in the collector bar, the horizontal current is reduced which helped us in running at a lower specific energy consumption. The

use of copper also helped reduce the cathode voltage.

At Aditya, we seal the copper collector bar's cathodes in the plant. The process goes through various steps of cleaning (shot blasting), pre-heating and sealing. Both the copper collector bars and the cathodes are pre-heated separately. After the pre-heating process, the collector bar is sealed with the cathode using cast iron. The process is carried out at temperatures of 1320°C-1380°C. The modified

lining composed of insulating bricks, refractory bricks and cathodes is done diligently in the lining shop.

We started the pilot project at three pots and with the consistent results we replicated the same in 228 pots in FY2021-22. With this initiative, we reduced the DC power consumption to 13,266 kWh/t which is 260 kWh/t lower than the standard design. The efficiency of copper insert collector bar pots is 94.8% which is 1% higher than the standard design.



# Natural Capital

## Responsible Consumption

Natural raw materials are elementary to our business. While consuming these resources, it becomes important for us to optimise their utilisation to bring about efficiencies that synergistically reduce costs. In FY2021-22, we consumed 11,586 kt of raw material. Expansion in our business and production has led to an increase in consumption compared to the previous year, with major contribution from the increased bauxite consumption to support the expanded alumina production.

We consumed 6.7 kt of packaging materials of which wood accounted for 4.3 MT. We recycled 7,372 MT of aluminium scrap procured from the external market and reused it in our operations. We are continuously exploring new markets for the recycling of aluminium and copper scrap.

## Raw Material Consumption (000MT)

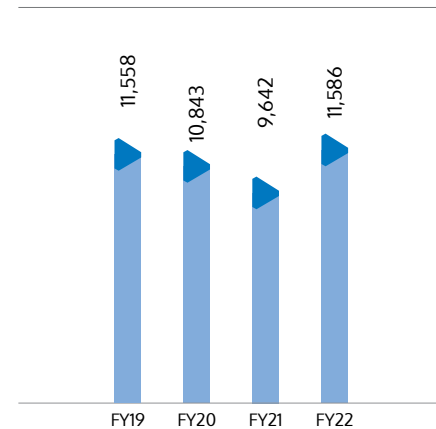

At our Novelis operations, we consumed 3,968 kt of raw materials out of which 2,214 kt was recycled material and 1,754 kt were other materials like alloys and sheet ingot. In FY2021-22, we used 57% of the recycled material in our operations, primarily using used in beverage cans.

Material type ('000 MT)	FY2018-19	FY2019-20	FY2020-21	FY2021-22
Bauxite	8,987.99	8,511.77	8,097.12	9,598.77
Aluminium Fluoride	21.20	19.44	17.82	21.78
Calcined Petroleum Coke	473.73	518.99	447.70	465.67
Caustic Soda	276.88	222.49	206.24	254.36
Pitch	105.74	113.05	100.69	137.77
Ammonia	77.11	56.10	1.02	0.02
Rock Phosphate	480.57	363.77	-	-
Copper Concentrate	1,134.83	1,037.30	770.90	1,108.06

### EFFORTS TO OPTIMISE NATURAL RESOURCE CONSUMPTION

We consume around 33,818 wooden pallets every year at Renukoot. With the aim to preserve our natural resources and to minimise our carbon footprint, we introduced an innovative design for the pallets which was successfully implemented in FY2021-22. We started by analysing the design of pallets used by other plants and used Computer-aided Design (CAD) to develop new and efficient structural models. We successfully developed a design with the same loading strength as the older one, and implemented the modified pallet in WRM coil packing. This project helped us achieve a saving of 5 kg or 0.23 cu.ft. of wood per pallet. The total saving of wood, thus accounted to 7,778 cu.ft. and cost savings of ₹34.8 Lakhs.

We also carried out a study on the production data and size of the billets used throughout the year. Feasibility was assessed to recollect the used wood runner between Renukoot and Mahan in every two months. After carrying out the studies, we started reusing the wood runner for billets and we were able to save ₹18 Lakh in FY2021-22.

Altogether with above mentioned initiatives for reduction of wood consumption, we were able to save 641 trees in FY2021-22, which resulted in cost saving of ₹52.8 Lakh.



## Waste as a Resource

We make conscious efforts to manage our waste in an environment-friendly manner. We follow 5R+1S approach (Reduce, Redesign, Recover, Rehabilitate, Recycle, and Store) to achieve our aim of becoming Zero Waste to Landfill by 2050. At Novelis, our target is to reduce waste to landfill intensity by 20% by 2026.

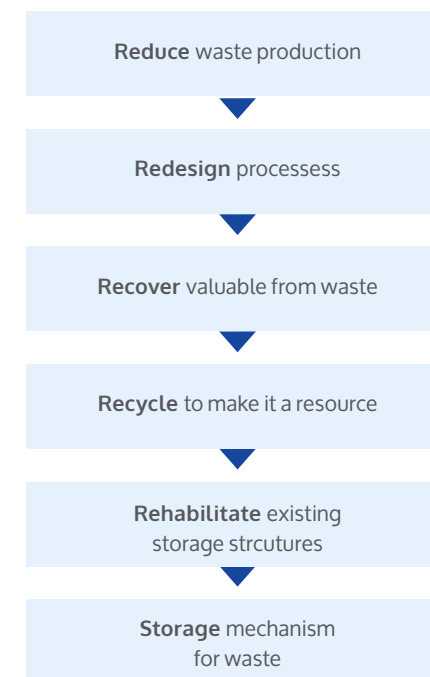

We have instated a task force for waste management at every unit. Our Waste Management Task Forces (WaMTF) have team members from different line functions who streamline the waste management process and prepare emergency preparedness and response plan. The WaMTF also identifies alternative technologies for waste management with support from the corporate leads. Our corporate sustainability team, including the Chief Sustainability Officer (CSO) conducts half-yearly reviews of the waste-related practices and projects.



Flyash is transported to cement plants via covered rakes

At Novelis, we have established a global committee for waste reduction. The waste data is entered into digital database and validated on quarterly basis by the EHS team. We conduct annual onsite audits to ensure ground implementation of waste related projects identified and implemented by the team.

In FY2021-22, our total waste generation for Hindalco and Novelis accounted for 11.98 Million MT out of which 11.6 Million MT was generated at Hindalco and 0.38 MT was generated at Novelis. Major wastes generated by our aluminium business are bauxite residue, fly ash, bottom ash, Spent Pot Lining (SPL), aluminium dross and vanadium sludge. Our copper business generates copper slag and fly ash as major waste. A total of 86% of our total waste was recycled. To reduce waste generation, we are improving efficiency across the value chain, some of these initiatives are mentioned in this report.

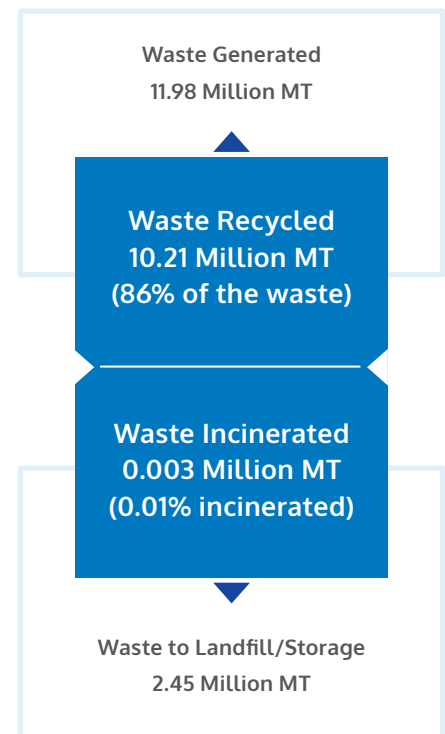

# Natural Capital

## Non-Hazardous Waste

In FY2021-22, we generated 11.44 Million MT of non-hazardous waste at Hindalco and Novelis. Over 93% of the non-hazardous waste generated comprises ash and bauxite residue categorised as HVLE (High Volume Low Effect) waste. The increase in waste generation is attributed to the expansion at our Utkal Alumina refinery. We are running multiple research projects to further increase the bauxite residue utilisation, especially at Utkal alumina, including road development, mine backfilling, polymerised bricks, soil amelioration and carbon capture projects.

In FY2021-22, eight of our sites have become Single-Use Plastic Free, certified by the Confederation of Indian Industry (CII). We are planning for another six sites to get certified in FY2022-23. As per Plastic Waste Management Rules on Extended Producer Responsibility, we are registered as brand owners and are complying with relevant EPR regulations and plastic recycling, with 100% of plastics being brought into the market, getting recycled through authorised recyclers. Our e-waste constitutes electrical and IT waste, which we sell to the authorised vendors. We also dispose-off the e-waste that we generate to authorised vendors for recycling and reuse.

### Non-hazardous Waste (Million MT)

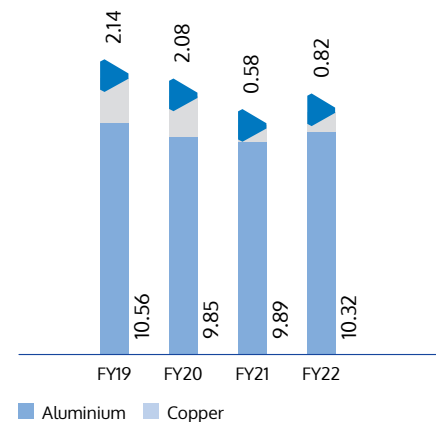

Our Municipal Solid waste (MSW) is generated by domestic households and canteens. We faced non-compliance for the burning of MSW and inadequate measures taken to control the fugitive emission from the raw material handling and fly ash transportation areas at Renusagar under the Air (Prevention and Control of Pollution) Act, 1981. We were levied ₹0.28 Crore; no fines were paid, and we took corrective actions. We initiated a proper mechanism for waste

segregation and disposal. The waste is segregated into compostable and non-compostable waste and we convert compostable waste to manure for use in our greenbelts, and send the non-compostable waste for further processing with a focus on recycling. To control the fugitive emissions, we installed water sprinklers and rain guns in the Coal Handling Plant (CHP) and initiated fly ash transportation by closed vehicles.

Type of Utilisation (Million MT)	Hindalco			Novelis		Total
	FY 2018-19	FY 2019-20	FY 2020-21	FY 2021-22	FY 2021-22	FY 2021-22
Recycled & reused	7.73	7.78	9.31	9.61	0.29	9.9
Landfill/TSFD	0.01	0.01	0.01	0	0.03	0.03
Stored in approved structures	5.69	4.28	2.14	2.31	0	2.31
Incineration	0	0	0	0	0	0
<b>Total</b>	<b>13.43</b>	<b>12.07</b>	<b>11.46</b>	<b>11.92</b>	<b>0.32</b>	<b>12.24</b>



Hindalco has industry leading waste utilisation practices

## Eight Sites Certified as Single Use Plastic-free by CII



## Hazardous Waste

In FY2021-22, we generated 0.52 Million MT of hazardous waste at Hindalco and Novelis. All the hazardous waste is handled with proper care, following applicable regulations, and ensuring the safety of our people. We have been able to make breakthroughs in the recycling of hazardous waste, especially in dross and spent potline, which has resulted waste to in high utilisation.

Novelis have a Spill Prevention Performance Standard for the handling of hazardous materials. This standard also applies to the contractors. We also have the Contractor Management Performance standard and all the contractors are given training at our sites annually. We conduct third-party audits for regulatory and performance standard compliance. Each of our sites undergoes a third-party audit once every four years.



Hindalco has taken a stand to move away from landfilling

### Hazardous Waste (Million MT)

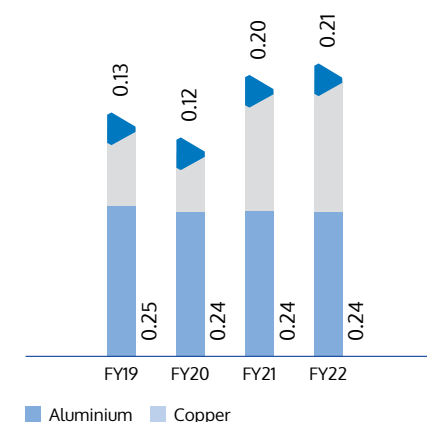

Type of Utilisation (Million MT)	Hindalco			Novelis		Total
	FY 2018-19	FY 2019-20	FY 2020-21	FY 2021-22	FY 2021-22	FY 2021-22
Recycled and reused	0.13	0.24	0.28	0.37	0.05	0.42
Landfill/TSDF	0.09	0.09	0.08	0.09	0.007	0.097
Stored in approved structures	0.09	0.03	0.08	0.01	0	0.01
Incineration	0	0	0	0	0	0
<b>Total</b>	<b>0.31</b>	<b>0.36</b>	<b>0.44</b>	<b>0.47</b>	<b>0.06</b>	<b>0.53</b>



# Natural Capital

## Maximising Circularity

We consider waste as a resource and make efforts to maximise its use and to scale down the use of new materials, in our industry as well as the others that we collaborate with. We have partnered with several cement companies to use our ash and bauxite residue as raw materials. In FY2021-22, we reused 102% of the bauxite residue from three alumina refineries. We utilised 114% fly ash in cement making, brick making, ready-mix concretes, and filling in low lying areas inside the plant boundaries. We have also installed in-house dross processing units to increase the utilisation of aluminium dross.

Novelis is the global leader in aluminium can recycling. At Novelis, we have established a close looped recycling system, where we produce aluminium from aluminium scrap that is procured from our customers. We have carried out several initiatives to recycle and reuse waste.

To increase the recycling of the used refractory, we initiated a project at Pinda, wherein we started the proper separation of waste during the furnace rebuild. The waste refractory was sent to a new off-site facility for recycling. The recycled refractory served as a raw material for new brick products. This initiative led to the reduction of 459 MT of refractory previously landfilled and saving ₹8.58 Lakh.



## Bauxite residue utilisation\* (%)

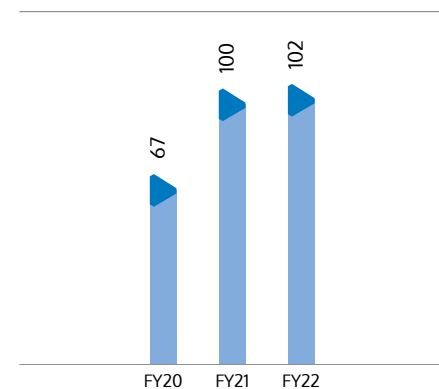

\* Bauxite Residue utilisation from 3 out of 4 refineries

## Ash utilisation (%)

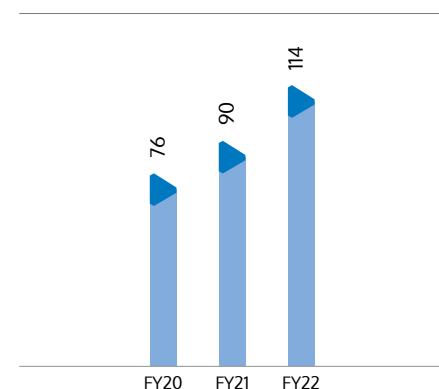

Red mud composite bricks

## REDUCTION OF HAZARDOUS SOLID WASTE AT BIRLA COPPER

The hazardous effluent generated during the copper production is transported to the Effluent treatment plant (ETP) and around 250 TPD of hazardous sludge is generated at the ETP. The hazardous waste sludge, containing Arsenic, Lead, Cadmium and Selenium, is disposed at the secured landfill sites. To reduce the volume of the effluent waste sludge at the ETP, we have developed an innovative process with the capability to reduce the waste sludge generation by 80%.

Our process involves three-stage neutralisation with selective pH control. It will generate around 60,000 MT of byproduct gypsum per annum which will be utilised as an additive in the cement plants and for the preparation of gypsum boards, plasters and blocks. We have completed the plant scale trials with the basic engineering activities.



## REPLACEMENT OF SAND BY COPPER SLAG IN READY-MIX CONCRETE (RMC)

To preserve precious river sand and increase the utilisation of the Cu-slag, we initiated a project to replace the 30-50% sand in RMC with Cu-slag. Copper slag (Cu-slag) is the byproduct of the smelting process of copper and is successfully used in many other applications. In the trials, we found that 50% of the sand can be replaced in the RMC while maintaining the required strength and performance.

After the successful trial, we started the commercialisation process. We sent Cu-slag to Ultratech Cement Limited (UTCL). We follow a three-stage procedure to utilise Cu-slag in RMC applications. In the first stage, we reduce the size of the Cu-slag at the source by process modification, as finer particles are required to mix in the RMC. After the size is reduced, in the second stage we start the screening process on the rack at the copper slag yard. We have deployed a third party for taking samples from the respective sites and transporting them to UTCL. In the third stage, finer materials are mixed in RMC to match the particle size requirements

at UTCL. At present UTCL replaces 30-40% of the sand with approximately 5000 TPM Cu-slag.

We are further modifying the processes for Cu-slag application. We also carried out feasibility for copper slag size reduction through slag granulation process modification.



# Natural Capital

## RICE HUSK- AGRICULTURAL WASTE BECOMES SOURCE OF POWER AT HIRAKUD

Biomass co-firing, the process of supplementing a portion of coal with biomass in high-efficiency coalboilers, is one of the most effective and easily implemented biomass energy technologies. Over the past few years, it has emerged as an efficient, clean, and cost-effective method for power generation.

In December 2019, we adopted the practice of biomass co-firing using rice husk at Hirakud power plant. Rice covers about 65% of the cultivated area in Odisha, thereby making rice husk a good source of biomass. Additionally, the plant's Circulating Fluidised Bed Combustion (CFBC) Boilers, which offer multi-fuel firing capabilities, high efficiency, and low emissions of Sox & NOx, can effectively utilise a variety of coal and alternate sources of fuel. The current monthly utilisation of rice husk is 3,000- 3,500 MT – increased from 0.3% to 1.4- 1.5% in two years.

A joint team has been formed between Hirakud Power and Thyssen Krupp for detailed analysis of:

- Field Survey & Assessment of alternate fuels
- Infrastructure requirements for Incoming Storage; Testing; Final preparation and Onward Feeding
- Boilers assessment
- Risk assessment and mitigation

The initiative has resulted in 1.4% of metal production being produced with biomass. The project has brought savings in tune of ₹22 Lakh/month. This projects helps us ensure compliance, reduce GHG emissions, and provides us with a sustainable alternative to coal.



Water Reservoir at Mahan

## Securing Water

Water is one of the most critical shared resources of the planet and equally important for us to run our operations. At Hindalco, we understand the importance of effective and efficient use of water. We have defined a structured approach to ensure water security in areas where we operate. This is guided by our well-defined targets across all our operations.

### At Hindalco, we aim to

- Achieve water positivity across our mining sites by 2025 and across all our operations by 2050
- Reduce 20% specific freshwater consumption by 2025 against the baseline of FY2018-19
- Achieve Zero Liquid Discharge status by 2025 across all our plants

### At Novelis, we aim to

- Reduce water use by 10% at all our operations by 2026 from the base year of 2020

We monitor our water consumption daily through flow metres and logs. The MIS

departments at the plants regularly update the water consumption data in the business-level management system. The collated data from all the plants is then used to prepare management reports for monthly review by our senior management. We also envision creating a central dashboard and monitoring system with digital dashboards for all the units.

We have set up Water Management Task Force (WMTF) at all units with members of relevant expertise in operational, utilities, and environmental functions. WMTF identifies risks pertaining to water use and plans for mitigation by taking up projects to achieve the Company targets. The task force members hold regular meetings at unit level and present the progress of initiatives to the Chief Sustainability Officer twice every year. The targets for each site are reviewed and projections are made for the Company level targets and their progress. These include targets related to water use efficiency, as well as targets for recycling, rainwater harvesting etc.

To foresee future usage and identify water stress, we use World Business Council for Sustainable Development's (WBCSD) India Water Tool (IWT) and World Resource Institute's (WRI) Aqueduct tool. These tools helped us evaluate the risk for baseline water stress, seasonal variability, flood occurrence, groundwater stress, and drought severity. We also identify critical sites to focus on with the necessary water conservation measures. We have a total of 5,885 KLD worth water efficiency projects completed, with 9,873 KLD worth of projects under implementation and 12,923 KLD worth projects being conceptualised. These new projects will enable us to achieve our water-related targets within the stipulated timelines.

Novelis has a Global Water Committee that focuses on water reduction for our processes. The Committee has regional representatives who meet monthly to implement strategic plans and discuss priorities. We track and monitor the water usage on a quarterly basis for all our plants at Novelis.

## Water Withdrawal

At Hindalco, our water withdrawal accounted for 77.98 Million m<sup>3</sup> in FY2021-22. Out of the total water withdrawal, 91% is sourced from surface water, followed by 8% from municipalities. Only 0.1% of the total water withdrawn is from the groundwater.

## Water Withdrawal (Million m<sup>3</sup>)

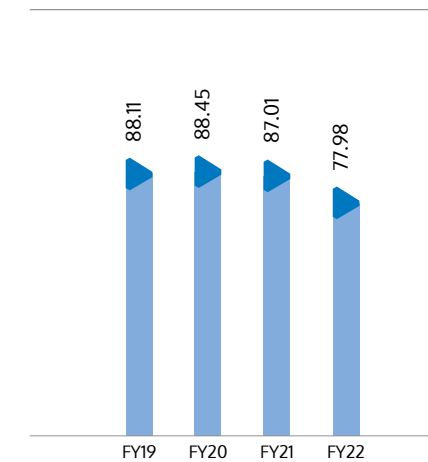

## Water Withdrawal by Source (%)

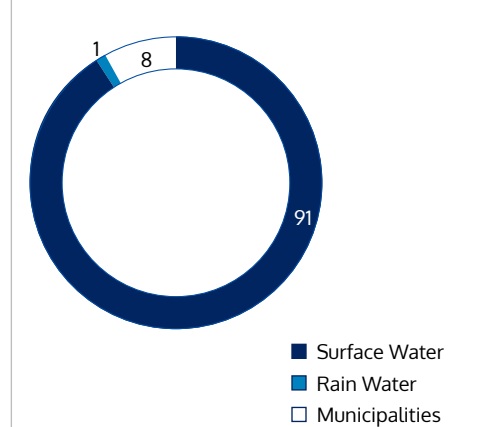

Source	Water Withdrawal (Million m <sup>3</sup> )*		
	Aluminium +Mines	Copper	Total
Surface Water	70.92	0	70.92
Groundwater	0.09	0	0.09
Rainwater	0.57	0	0.57
Municipalities	0.13	6.27	6.40
<b>Total Freshwater Withdrawn</b>	<b>71.71</b>	<b>6.27</b>	<b>77.98</b>

\*Water Withdrawal for Novelis is the same as water consumption.

## Water Consumption

We require a significant amount of water in the production process of aluminium. By design, cooling towers use a large quantity of water.

As an effort to reduce water loss due to evaporation, drift, leaks, and blowdown at cooling towers, we are exploring projects to capture the losses to reduce water use significantly.

## Water Consumption - Freshwater and Recycled water (Million m<sup>3</sup>)

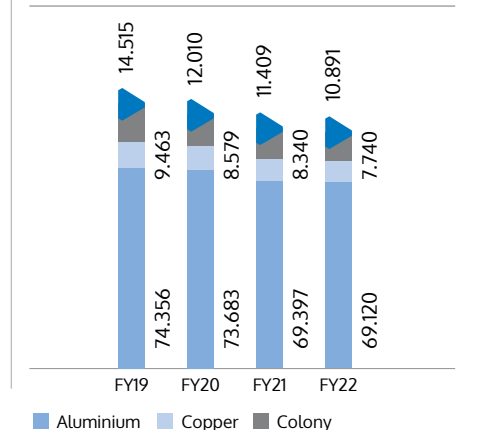



# Natural Capital

Freshwater Consumption Aluminium, Copper and Mines (In Million m <sup>3</sup> )				
Parameter	FY2018-19	FY2019-20	FY2020-21	FY2021-22
Total municipal water supplies (or from other water utilities)	6.2	7.88	11.08	4.99
Fresh surface water (lakes, rivers, etc.)	55.6	61.11	48.99	55.32
Fresh groundwater	0.08	0.07	0.04	0.07
Rainwater consumption	2.18	0.09	3.55	0.44
<b>Total Net freshwater consumption</b>	<b>64.06</b>	<b>69.15</b>	<b>63.66</b>	<b>60.82</b>

At Novelis, water is mainly used for cooling purposes, we monitor water usage at our plants quarterly. Our water consumption has increased due to water usage by eleven new plants. The increase in water consumption is also due to an increase in production by 7%.

Freshwater Consumption- Novelis (In Million m <sup>3</sup> )				
Parameter	FY2018-19	FY2019-20	FY2020-21	FY2021-22
Total municipal water supplies (or from other water utilities)	2.03	2.28	3.17	3.44
Fresh surface water (lakes, rivers, etc.)	3.13	3.26	4.35	4.22
Fresh groundwater	3.69	3.92	4.69	4.61
<b>Total Net freshwater consumption</b>	<b>8.85</b>	<b>9.46</b>	<b>12.21</b>	<b>12.27</b>

## Water Intensity

We have achieved a 9% reduction of specific freshwater consumption in our aluminium operations and a 24% reduction of specific freshwater consumption in our copper operations base FY2018-19 largely due to closure of fertiliser operation and recycling efforts. We have recalculated and restated the information provided for specific freshwater consumption for our copper plant for FY2020-21.

At Novelis, with continuous efforts, we have reduced the water intensity by 26% from FY2009-10 to FY2019-20. To further reduce the water intensity, our focus is on the optimisation of water usage at cooling towers.

## Specific freshwater consumption - Aluminium (m<sup>3</sup>/MT)

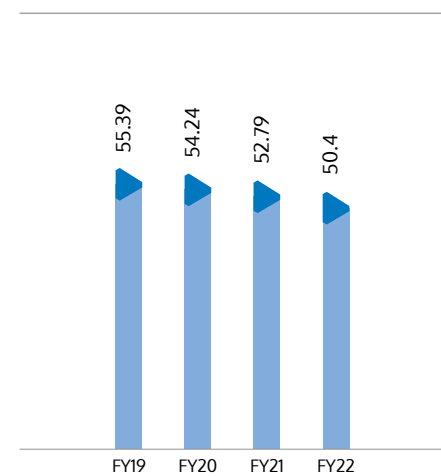

## Specific freshwater consumption - Copper (m<sup>3</sup>/MT)

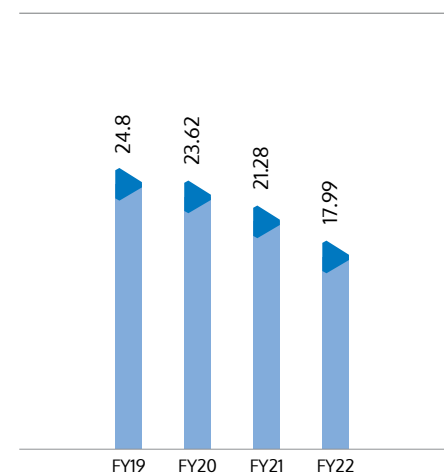

The shallow land with rainwater harvesting structure has become a natural habitat for local and migratory birds

## Water Recycling

We at Hindalco have adopted processes to recirculate, reuse and recycle the outlet process water to achieve Zero Liquid Discharge (ZLD) and freshwater reduction. We are constantly finding ways to make our processes more water efficient. We have identified and implemented several water recirculation projects through which we can use the outlet water of one process as input water of the other with minimal treatment. This will enable us to use less water, decreasing the loads on the water recycling systems and saving the associated treatment costs. Our refinery operations are sustainable by design, which recirculate caustic soda repeatedly through closed loop systems, reducing the freshwater top-up requirement.

In FY2021-22, we recycled 16.1 Million m<sup>3</sup> of wastewater in aluminium and copper plants. A total of 20.94% of wastewater was recycled in aluminium operations and 20.31% in copper operations.

Our Dahej and Belagavi plants fall under the water stress area. We have commissioned a 700 KLD tertiary water treatment plant at Dahej, complete

## Water recycled -Aluminium (%)

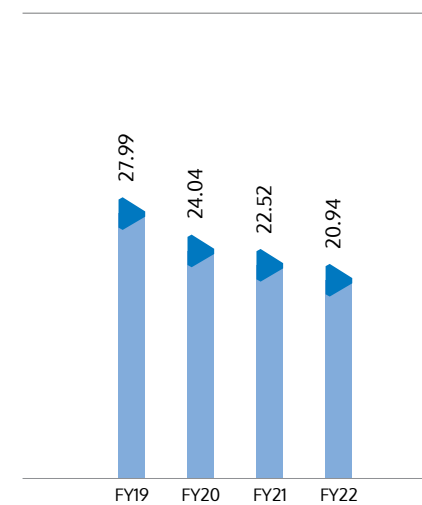

with Reverse Osmosis (RO) filtration and Mechanical Vapor Recompression (MVR) based thermal solution for complete reuse of treated water. We have been able to achieve over 27% reduction in specific freshwater consumption over the last year at Dahej, partly due to the decommissioning of our fertiliser operations. We plan to

## Water recycled -Copper (%)

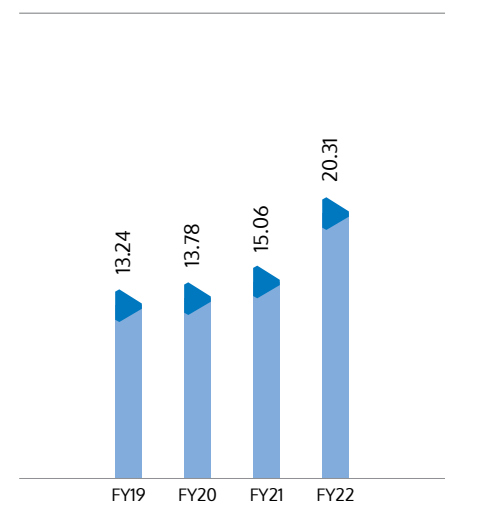

start using desalinated sea water at Dahej from FY2022-23, sourced from a local common desalination plant of GIDC. Through close looping at the Belagavi site, we have been able to achieve a 40% reduction in specific freshwater consumption from a baseline of FY2018-19. We have been well ahead of our targets at both the sites.



# Natural Capital

## Effluent Management

To achieve the ZLD status, we at Hindalco plan to cover one site every year till 2025. In FY2021-22, our total effluent discharge was at 340,370 m<sup>3</sup>. The increase in discharge is due to the increased production at sites and we have plans in place for these sites to become ZLD by 2025.

We follow the relevant CPCB and SPCB guidelines for effluent discharge, and ensure conformity to all the required quality parameters. Before the effluent discharge, we constantly monitor the chemical properties of wastewater such as Fecal coliform, Biological Oxygen Demand (BOD), Chemical Oxygen Demand (COD), Total Soluble Solids (TSS), Total Dissolved Solids (TDS) and heavy metals as per regulatory guidelines.

At Renukoot, we faced non-compliance under Water (Prevention and Control of Pollution) Act, 1974, for not achieving ZLD conditions and discharging wastewater into the environment. We were levied ₹1.37 Crore, no fines were paid and we took corrective actions. We installed a 4,000 KLD PWRP system to resolve the issue. The treated water from the STP is used in horticulture and the rest is discharged into Murdhawa Nala.

## Effluents Discharge -Aluminium

(000' m<sup>3</sup>)

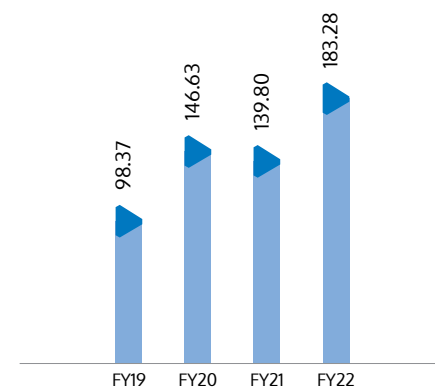

## Effluents Discharge -Copper

(000' m<sup>3</sup>)

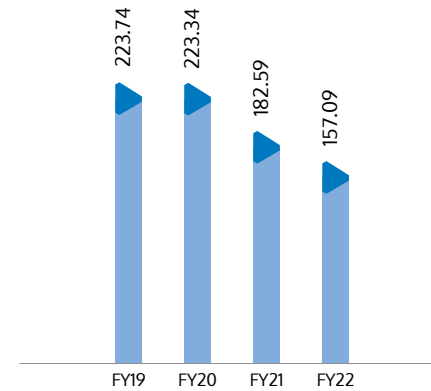

At Novelis' Changzhou plant in China, we have implemented ZLD, which is applied to automotive processing lines. We faced one incident where the oil and grease at Richmond Water exceeded the standards, which was resolved with immediate effect.



Local community engages in pisciculture and duck rearing in rainwater harvesting structures at Bagru mines

Discharge outlet	Effluent Discharged (m <sup>3</sup> )	
	Aluminium	Copper
River	1,20,162	0
Industrial Drainage system	15,611	0
Deep Sea	0	1,57,093
Sanitary Sewer	3,712.74	0
Municipal WWTP	43,791	0
<b>Total Discharged Effluent</b>	<b>1,83,276.74</b>	<b>1,57,093</b>

## Initiatives taken for Managing Water

We believe that integrated watershed management is a key aspect of water conservation. We have undertaken various initiatives as a part of our watershed management programme which include the construction of bunds, gully plugs, rainwater harvesting ponds, contours and terraces. We use harvested rainwater for our mining operations to minimise the consumption of groundwater. Our focus is on developing solutions for sustainable water management and we are collaborating with industry leaders to achieve it.

To increase the awareness of responsible water consumption and regeneration of water resources, we are working with the local communities, Gram Panchayat and several NGO's. Our CSR vertical developed infrastructure for rainwater storage outside the boundary with capacity over 3.1 Million m<sup>3</sup>. Our units have also developed structures for rainwater and raw water storage with a total capacity of 10.69 Million m<sup>3</sup>.

Structures Type	Structures at Plants (Nos)	Structures through CSR(Nos)
Check dams	26	133
Injection wells	2	-
Ponds	33	169
RC Tank	2	-
Recharge Pit	9	-
Rooftop systems	12	-
Cannel	-	2
Reservoir	-	4
WHT	-	13
Trench	-	16
<b>Total</b>	<b>84</b>	<b>337</b>



# Natural Capital

## WATER MANAGEMENT INITIATIVES AT MOUDA



With the aim of reducing freshwater consumption, we took the following initiatives:

- Installed rainwater harvesting pond equivalent of 14 KLD; started to use treated effluent water at cooling tower
- Used recycled domestic water for construction work at the sewage treatment plant
- Started collecting and reusing RO reject water from centralised drinking water at admin, washrooms, and foil plant

With these initiatives, we were able to reduce freshwater consumption and freshwater intensity. We have reduced the freshwater intensity by 32% as compared to FY2018-19.

### Water Consumption (MT)

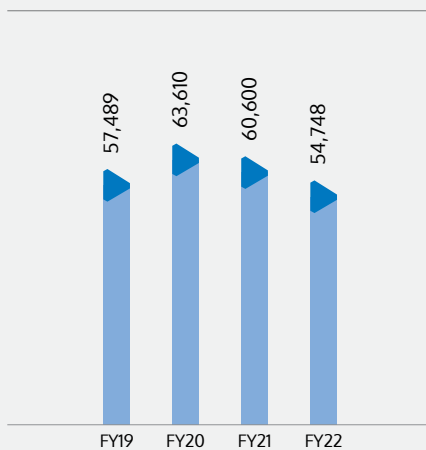

## RECIRCULATION OF ACF/ MGF BACKWASH WATER AT RENUKOOT

At Renukoot, we have eight Demineralised (DM) water units with a total capacity of 390m<sup>3</sup>/hr., to meet the requirement of boiler plants. At DM units, salts from raw water are removed by using an ion-exchange chemical process. The DM water is then used as feed for boiler plants.

After 20 hours of use, the active ion concentration in the DM units reduce. So, regeneration of our DM units is done to enhance the active ion concentration. Approximately 910 m<sup>3</sup> of water is used for regeneration and filter backwash. The backwash water from the Multi Grade filter (MGF) and Activated Carbon Filter (ACF) is turbid and acidic. So, the backwash water is neutralised at the neutralising pit, from where it used to be diverted to the ash pond, while the excess water was sent to the ETP.

We conducted a study to check the feasibility of reusing the backwash water as DM feed water. As a solution, we developed a ZLD pit to collect the MGF/ACF backwater from all the DM units. Backwash water is treated at the ZLD pit and then pumped into the clear water tank. With this initiative, our water consumption has gone down by 587 KLD and cost savings of about ₹13.39 Lakh per year have been realised.

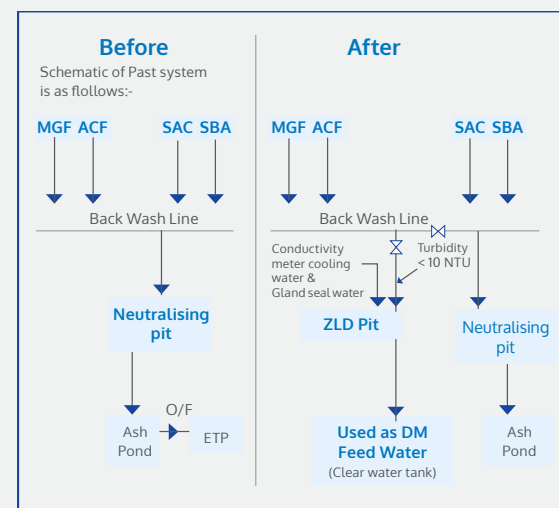

## UTILISATION OF EVAPORATION # 4 ALKALINE CONDENSATE OF ALUMINA PLANT HAVING CONDUCTIVITY (< 100 MICRO MHO) AS DM FEED WATER TO BOILER

To reduce freshwater consumption and reduce the effluent load on ETP at the Renukoot plant, we developed infrastructure for pH correction system with auto controller. Initially, Evaporation # 4 Alkaline condensate of Alumina plant was sent to the 'Bad condensate tank' and then to the Effluent treatment plant. We conducted a study and found out that Evaporation # 4 Alkaline condensate having conductivity of <120 Micromhos and pH 9.8 can be used as DM water after pH correction.

To execute the process, we laid a pipeline in the boiler area and other modifications in-house. This procedure was executed in-house. We had faced few challenges during the implementation as the condensate required continuous monitoring for pH and TDS. We then diverted the Evaporation # 4 Alkaline condensate to sampling tanks 2 and 3. We conducted CRC overhauling, calibration, and modification to divert the condensate.

The initiative has led us to save 400 KLD. We are reviewing and modifying the process even further to save upto

600 KLD. Initially, the water consumption was 4,769 KLD and after implementing the project, our water consumption has gone down to 4,369 KLD. This has resulted in 8.4% freshwater reduction and cost-saving of ₹9.13 Lakh per year.

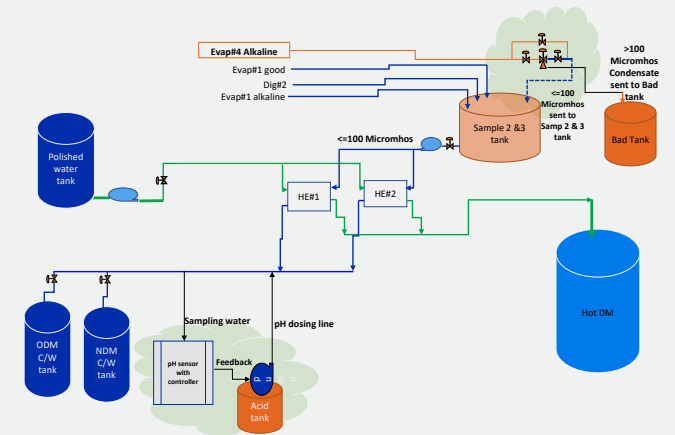

## REDUCTION IN FRESHWATER CONSUMPTION IN MAHAN



With the aim to reduce freshwater consumption and contribute toward water positivity, we installed a next-generation 3D TRASAR™ Technology automatic dosing system which provides real-time monitoring for cooling water and helps to avoid fluctuations in parameters in the cooling tower. Upon commissioning this technology, we observed improved water quality and reduced blowdown in cooling towers, soft water plant cycle changed from 20 hours to 30 hours and the side stream filter back washing practice changed from a daily basis to on demand. We replaced the rusty water pipelines and closed the monitoring of cooling drift loss and water-cooling circuits.

We also conducted a water leakage audit from supply to end-user point. With the installation of this technology, we observed increased Cycle of concentration (COC), optimised chemical concentration and a 15% reduction in freshwater consumption. We saved 9,221 m<sup>3</sup> of freshwater in FY2021-22 which resulted in a cost saving of ₹18.44 Lakh.

# Natural Capital

## WATER IMPROVEMENT PROJECT AT PINDA

Our approach towards enhancing water efficiency at our Pinda plant has been 3 pronged- increase the availability of water, improve the quality of water, and recycle the water.

For increasing the availability of water, we installed a new water intake

pipe in the adjacent river. With this, we assured availability of a reliable water source for our operations and processes.

To treat the water sourced from the river, we installed a new water treatment plant. The WTP removes

sediments and solids from the water which provides high-quality water and increases the water use efficiency in the plants. The WTP captures rainwater and recycles it using reverse osmosis. With these projects installed, we saved 71,893 m<sup>3</sup>/year and resulted in saving ₹1.27 Crore

## Sustainable Mining

Hindalco owns and operates 17 manufacturing units and 21 operational mines across India. We operate across large areas of land, within varied habitats. We believe in harmonious co-existence with nature and all its beings and it is crucial for us to nullify any impacts that our operations may have on the health and richness of surrounding ecosystems. We work in 8,569 ha of the operational mining area in the coal and bauxite sectors.

Mining Area Details				
Parameter	FY2018-19	FY2019-20	FY2020-21	FY2021-22
Total mining area leased (Operational) (Ha)	9,977	9,278	9,133	8,569
Total area mined out (Ha)	155	132	80	106
Total area reclaimed (Ha)	156	112	86	92
Total area rehabilitated (Ha)	94	102	57	85

## THE SUSTAINABLE MINING CHARTER

As biodiversity and natural resource preservation becomes material areas for sustainability in mining locations, so does the pre-existing poverty and poor access to health, education, infrastructure and information. The crucial role of sustainability in extractive mining needs specific, structured approach and guidelines in order to arrive at practical and long-term solutions. The Sustainable Mining Charter (SMC) embodies Hindalco's effort towards building a theme-based practical and actionable guideline for sustainability.

SMC is a guideline document to provide a structured framework for achieving sustainable mining goals in a holistic way by focusing on the ESG Framework. It also guides us how to develop Sustainability Goals for Focus/Thematic Areas and an implementation Road map to achieve these goals. Further, it has cited several case studies to provide insights into the practical aspects of implementation.

After unveiling SMC in June 2021, Hindalco has commenced its implementation. We believe that with the adoption of SMC, the management can channelise its resources and

focus on a structured way to achieve definite goals in each focus area of the mine. Besides, fulfilling the needs of the Local People, Maintaining the Environmental Conditions and Improving Productivity, the focus will help in market value creation, meeting international stakeholder expectations, and may also assist in securing funding from agencies in certain cases. We have taken various initiatives like duck farming, aquaculture, mushroom cultivation, and vermicomposting under the Corporate Social Responsibility (CSR) in line with the thematic areas as per the sustainable mining charter.



Hindalco has developed plans for flora and fauna conservation

efforts to avoid deforestation, but we do acknowledge the nature of our business being extractive which requires a lot of cleared land area. We also take up transplantation projects whenever scientifically possible. We comply with applicable laws and regulations pertaining to forest conservation. We are committed to No Net Deforestation\* at our sites of operation.

Green belt development is one of our short-term targets for biodiversity management. Green belts act as living walls and offsets emissions. We use them for green belt development as native species survive well and keep the natural ecosystem of the region intact. In FY2021-22, we developed 12 green belt development plans at the non-IUCN sites to serve as BMPs. We conducted greenbelt assessment for carbon sequestration potential for Dahej unit in the reporting year as well. We have developed a company-wide SOP as well on developing dense and healthy greenbelts and are driving quality improvements in plantations

## Safeguarding Biodiversity

We have committed to achieving No Net Loss (NNL) by 2050 and this goal is supported by our Biodiversity Policy and Technical standards. We conducted a biodiversity assessment for 48 sites using the Integrated Biodiversity Assessment Tool (IBAT) tool which resulted in identifying high-priority sites for biodiversity management. To achieve NNL, we have set out short-term and long-term objectives for identified high-priority sites through the development of

detailed Biodiversity management plans (BMP) with the International Union for Conservation of Nature (IUCN). We have developed four BMPs for five sites last year in India. Now we have another five BMPs spanning 10 sites near completion, that will take the total to fifteen sites with detailed 4-season BMPs. The total sites having BMPs stands at 26 out of the 32 sites having exposure to biodiversity impacts.

Whenever we are expanding or upgrading operations, we make

\* No Net Deforestation means and includes commitment to reforestation to compensate against forest loss caused due to operational activity as well any permissible pre-emptive clearing, in accordance with the applicable local laws.



A unique concept of bio park has been adopted at Hindalco's Bagru mines



# Natural Capital

by training people and through constant monitoring at sites. Our current greenbelt stands at over 5,144 acres with over 4.5 Lakh trees planted in the reporting year.

We are planning to conduct a rehabilitation activity at the Ash Mound of Hirakud S&P, where we plan to create an entire forest ecosystem on the closed ash dyke.

To make a conscious effort towards identifying and minimising the impact, we at Novelis carried out an assessment using IUCN guidelines for Planning and Monitoring Corporate Biodiversity Performance. The guidelines help in identifying the pressure on biodiversity, plan to reduce the impact and set measurable targets. The assessment produced that no anthropogenic pressures require goals or targets to reduce the impact but as a

**Green Area Plantation** (Acres)

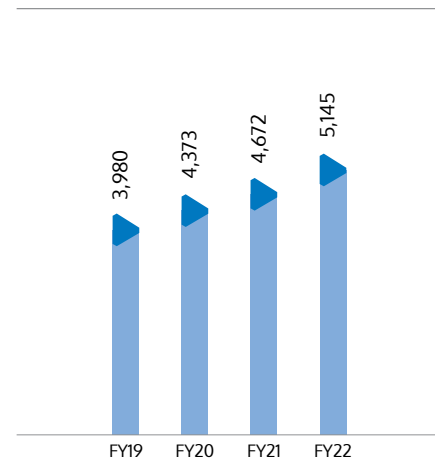

responsibility toward the environment. We have identified six anthropogenic activities that need to be controlled to minimise the impact. We also conducted

**Tree Plantation Trends** (Number)

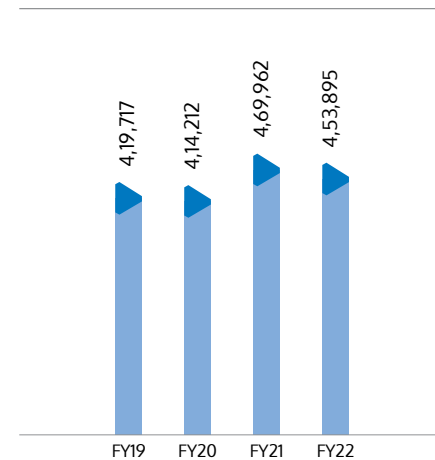

a biodiversity assessment for all our sites and none of our sites are near critical biodiversity.

## MIYAWAKI PLANTATION IN ADITYA

Miyawaki technique is a unique plantation methodology proven worldwide, irrespective of soil and climate conditions. Various native types of plants are planted close together in the Miyawaki system so that the greens only receive sunlight from the top and grow upwards rather than laterally. The plants become self-sustainable and are 30 times denser. The Miyawaki plantation method helps in noise and dust reduction. We applied the Miyawaki plantation technique at the CHP area as it is a high dust location.

As the site selected was waterlogged barren and we had to clear the area before the plantation. Our plants are yielding a 99.5% survival rate with a high growth rate. Due to the presence of a diverse range of plant species, it is currently serving as a hotspot for butterflies. We invested ₹50,000 for the plantation initiative, which also aligns to the requirements of the IUCN mitigation plan.

With the positive outcomes from the plantation at Aditya CHP, we are planning to replicate the technique of plantation at the smelter plant location where we are expecting this to be a nature-based solution for fugitive dust mitigation. Renukoot, Renusagar and Mahan have already started their own Miyawaki plantation patches.



## INITIATIVES UNDER BIODIVERSITY MANAGEMENT PLANS AT VARIOUS SITES



We developed four BMPs at Utkal Alumina, Aditya Aluminium, Gare Palma and Baphlimali and implemented initiatives as proposed in the BMPs.

### Conservation initiatives at Utkal Alumina

At Utkal Alumina we undertook an afforestation programme. In FY2021-22, under this programme, we added 20% new species. To increase bird diversity, we identified sites with primary or secondary hole-nesting bird species. To attract such species, we installed 52 nest boxes on the trees with a low density of mature tree cover. We also monitored the species after installing nest boxes. With the aim to plant native species during the afforestation programme, we collected seeds to prepare saplings of the indigenous species. For this, we collected seeds from the local forests and dried them to make them ready for further stages. After the seeds

were ready, we prepared a poly pot to develop saplings. The poly pots were planted in our in-house nursery under the afforestation programme.

### Conservation initiatives at Gare Palma

We extract coal from our Gare Palma mine in Chhattisgarh. In FY2021-22 we planted 10,025 saplings in an area of around 4 ha near the coal mines. Due to the continuous afforestation programmes undertaken at Gare Palma, the green cover there has increased by 5.7%. We also undertook plantations under the Wadi Project for a sustainable tribal livelihood project. A total of 20 ha of land was covered under this project.

### Conservation Initiatives at Baphlimali

At our Baphlimali bauxite mine at Utkal Alumina, we continuously carry out afforestation programmes to

reduce the impact of mining. Through continuous afforestation efforts, we planted 50% more new species in FY2021-22 compared to FY2019-20. In addition, we also carried out rehabilitation of 15 ha of area and slope plantation of 20 ha.

### Conservation Initiatives at Aditya Aluminium

At Aditya Aluminium, we identified sites with the presence of native butterfly species and prepared a butterfly conservation and habitat enhancement action plan. As per the plan, we developed 2,000 sq.m of butterfly conservation area at Aditya Aluminium. To attract butterflies and pollinator insects we planted native trees, herbs and shrubs in the conservation area. We have also installed 25 nest boxes to attract bird species. In addition, we added 20 new plant species in FY2021-22 as compared to FY2020-21.





# Social and Relationship Capital



## Partnerships that drive growth

Unleashing the potential of people and creating value for our communities is one of our top most priority. Over the years, Hindalco has built strong partnerships with its stakeholders based on mutual trust and respect. Our commitment to ESG and value enhancing growth drives all the efforts we make to cater to stakeholders' expectations. We believe that long-term value creation and mutual growth can only happen by fostering stakeholder synergies.

### Key Highlights

**₹87.6 CR**  
Community expenditure

**1.26+ MN**  
Lives touched

**15,673**  
Number of suppliers

**₹1,48,236 CR**  
Procurement spend

### Contributions to SDGs



### Value Enhancing Growth

<b>SP-2</b>	<b>SP-3</b>
Value enhancing growth	Strong ESG Commitment

### Interlinkages with Material Topics and Other Capitals

Material Topics	Capitals Connected
Community Relations	Financial Capital
	Manufactured Capital
	Human Capital



### Our Focus Areas

Strengthening ties with communities	Fostering customer relationship	Responsible supply chain
-------------------------------------	---------------------------------	--------------------------



# Social and Relationship Capital



Hindalco supports several women - run SHGs under its CSR initiatives

## The Strategy is guided by our CSR Vision-

“To actively contribute to the social and economic development of the underserved communities, lifting the burden of poverty, and helping bring in inclusive growth in sync with the UN Sustainable Development Goals. In doing so, build a better, sustainable way of life for the weaker sections of society and raise the country’s Human Development Index”.

### Engage, Uplift and Empower

In line with our Group’s Corporate Social Responsibility (CSR) motto of ‘Engage, Uplift and Empower’ and Hindalco’s strong ESG commitments, we constantly strive to make a positive difference to the lives of people in the areas we operate in. Over the years we have relentlessly worked towards enriching the lives of all our stakeholders and will continue to contribute towards building a self-sufficient and sustainable future for society at large.

Our CSR strategy to engage, uplift and empower the community around us is aligned to the 10 SDGs - No Poverty, Zero Hunger, Quality Education, Good Health & Wellbeing, Clean Water & Sanitation, Affordable and Clean Energy, Decent Work & Economic Growth, Gender Equality, Reduced Inequalities & Industry, Innovation & Infrastructure.

We have a total of 50 production assets and 19 mines. All of them have gone through community consultation process before establishment. Additionally we have undertaken 11 development projects to enhance our production. Out of them, 6 projects are in the process of community consultation.

At Novelis, our plant managers and other teams are in constant touch with local communities. They actively acknowledge the issues faced by the locals and resolve them in the best possible way. We conduct feedback sessions with local stakeholders for engagement. Each site has a site champion with responsibility to lead the community development projects. We also aim at advancing Science, Technology, Engineering and Mathematics (STEM) education and sustainable development in the local communities.

## Our company’s CSR initiatives focus on five thrust areas

4 QUALITY EDUCATION	3 GOOD HEALTH AND WELL-BEING	16 PEACE, JUSTICE AND STRONG INSTITUTIONS	8 DECENT WORK AND ECONOMIC GROWTH	11 SUSTAINABLE CITIES AND COMMUNITIES
Education	Health Care	Social Reforms	Sustainable Livelihood	Infrastructure Development
<ul style="list-style-type: none"> <li>Enabling enrolment of students</li> <li>Scholarships</li> <li>Co-curricular activities</li> <li>School infrastructure development</li> <li>Distribution of educational materials and uniforms</li> </ul>	<ul style="list-style-type: none"> <li>Health camps</li> <li>Addressing malnutrition</li> <li>Healthcare infrastructure development</li> <li>Preventive and curative care</li> <li>Mother and Childcare</li> </ul>	<ul style="list-style-type: none"> <li>Addressing social stigmas and issues</li> <li>Old age home support</li> <li>Providing disaster relief</li> <li>Financial literacy</li> <li>Breaking social stigmas</li> </ul>	<ul style="list-style-type: none"> <li>Vocational job-oriented skill training</li> <li>Technical skill training</li> <li>Distribution of agriculture tools, seeds, fertilisers, and insecticides to farmers</li> <li>Supporting Self-Help Groups (SHGs)</li> </ul>	<ul style="list-style-type: none"> <li>Village road construction</li> <li>Community water source</li> <li>Maintenance of heritage</li> <li>Disaster Relief</li> </ul>

\*\* 100% of beneficiaries of the CSR projects and programmes are from vulnerable and marginalised groups

### From Strategy to Practice

In line with our Group’s CSR vision, Hindalco has adopted socially responsible practices where these SDG goals are enumerated through the five focus areas of education, health care, sustainable livelihood, social empowerment, and infrastructure development.

### Investing in Communities

We spent ₹55.04 Crore on community development projects at Hindalco to strengthen our commitment towards Corporate Social Responsibility (CSR). We have spent a total of ₹39.3 Crore in 10 identified aspirational districts of Odisha, Madhya Pradesh, Uttar Pradesh and Jharkhand through our CSR projects.

Hindalco	FY2018-19	FY2019-20	FY2020-21	FY2021-22
Community Expenditure (₹Crore)	44.57	48.65	53.99	55.04

The total philanthropic contribution by our Novelis operations is US\$4,291,644, equivalent to ₹32.6 Crore. The category-wise contribution details are provided in the table below.

Type of Contribution	Total amount (in USD)
Cash contributions	3,493,644
Time: employee volunteering during paid working hours	348,000
In-kind giving: product or services donations, projects/partnerships or similar	300,000
Management overheads	150,000





## Community Stewardship Initiatives

### Education

Recognising the value of education in community development, we promote a conducive learning environment through our holistic initiatives. Pre-school education, educational support programme, vocational and technical education training, adult literacy programme and school infrastructure development are some of our key areas of focus. This opens doors to opportunity, promotes social mobility and aids in the reduction of inequity. It is critical for breaking the cycle of poverty and cultivating tolerance-which leads to a healthy and progressive society.

Our Education Programmes are mainly aligned with 3 SDGs - Quality Education, Gender Equality and Reduced Inequalities. Through our education programmes and initiatives, we supported 7,607 students in rural areas. Following are outcomes resulting from our Education Programme in FY2021-22:

<p><b>Supported 2,168 students in 56 Aanganwadi and Balwadi Centres</b></p>	<p><b>7,514 students enrolled in 18 Aditya Birla Public Schools and Aditya Birla Vidya Mandirs</b></p>	<p><b>122 adult learners gained literacy skills through 4 Adult Literacy Programmes</b></p>
<p><b>Nurtured 11 malnourished children into healthy children, under Integrated Child Development Scheme (ICDS)</b></p>	<p><b>36 schools were constructed/ repaired to upgrade the existing infrastructure</b></p>	<p><b>Distributed educational materials and uniforms to 10,349 students</b></p>

An impact assessment study of CSR activities of Utkal Alumina International Ltd. carried out by NABARD Consultancy Services during FY2018-19 for our education sector initiatives indicated the following impact. Due to the challenges posed by COVID-19, we could not carry out the impact assessment this year.

Key Performance Indicator	Unit	Baseline (FY2010-11)	Impact (FY2018-22)
Total literacy rate	%	37.74*	51.56**
Women literacy rate	%	22.51*	36.51**
School enrolment	%	92.06***	97.85**
School attendance	%	65	100#
School dropouts	%	4.75	2.65#

\* Indicates 2011 census data.

\*\* Indicates NABCONS study data, 2018

\*\*\* Indicates Child Tracking System Data of the operational Gram Panchayats, Odisha Primary Education Programme

Authority, Government of Odisha, Bhubaneswar, 2009-10.

# Impact assessment study conducted by Xavier Institute of Social Services, Ranchi in 2016-17

### Key benefits from the initiatives

We undertook several education related projects and programmes with the objective to enable the financially and socially backward children from our communities to become financially independent in the future. These initiatives have helped us develop a strong bond with the community. An educated community ensures we will have access to local talent in the years to come, with an increase in availability of educated and skilled local manpower. This helps in creating local employment opportunities, contributing to improved quality of life and increased goodwill of the community and local government.

### Healthcare

Good health is key to individual wellbeing. We have been standing strong with the communities, throughout all the three waves of the COVID-19 pandemic, addressing health issues and providing solutions that meet essential healthcare requirements.

During the year, we undertook several healthcare programmes and initiatives aimed at improving accessibility to better healthcare services for vulnerable sections of society. These initiatives cover preventive healthcare programmes, curative healthcare, mother and childcare, quality/support programmes and development of healthcare infrastructure. Our healthcare projects include eye camps, dental check-up camps, tuberculosis camps and general health counselling. We helped treat 61 cases of Tuberculosis. A total of 292 cases of cataract surgery were undertaken. Our adolescent healthcare programme extended support to 1,728 girls.



“Fostering a healthy society by creating awareness on health-related issues and providing access to essential medical infrastructure”



# Social and Relationship Capital

Some of the highlights from our health-related CSR projects are:

Running 5 hospitals, 16 dispensaries/clinics and 23 family welfare centres	112,356 beneficiaries from our hospitals/dispensaries/clinics/family welfare centres	30,981 mothers and children helped by family welfare centres
71,744 people aided through 2,226 medical camps	25,276 attended 62 seasonal disease (Malaria/Diarrhoea)	373 Health and Nutritional awareness programmes organised
145,594 children given Pulse Polio drops; 35,165 children vaccinated against other life-threatening diseases	22 eye camps organised and 292 cataract surgeries performed with 1,752 total beneficiaries	11,014 mothers registered for Antenatal/Postnatal Care (ANC/PNC)

## VISION CENTRE- EASY ACCESS TO AFFORDABLE EYECARE

**Implementing partner-** Trilochan Netralaya

**Services provided-** Complete eye check-up, cataract screening, eye pressure/glaucoma check-up, retina check-up, spectacles, medication, diabetic eye disease screening, school eye health camps, consultation with eye specialist through real-time live video conference.

**Aditya Aluminium** partnered with **Vision Foundation**, a trust of Trilochan Netralaya, Sambalpur, to implement and manage the Vision Centre project, including providing technical experts for clinic management and conducting outreach activities. The objective of the project was to ensure prevention of avoidable blindness by promoting awareness of good eye health in all sections of the community, especially vulnerable and marginalised people.

Earlier, people from Rengali Block and adjacent blocks had to travel 25 km to Sambalpur for eye- screening, check-up and spectacles. With the Vision Care Centres, we provided doorstep services through camps in villages, free eye check-ups in school and employment to local youth as optometrists. There is a significant increase in the uptake of eye care services, thus, leading to considerable reduction in the burden of avoidable blindness. Most of the problems are addressed locally at the vision centres and only a small number are referred to either a secondary or a tertiary level hospital for further management. This has benefited senior citizens, people above 40 years, and school students.

We were able to conduct 12 eye health camp in a year with an outreach to more than 100 villages.

**Lives touched**

**3,000**

Eye patients treated through OPD Eye Health Care

**10,000+**

People reached through door-to-door campaign and Panchayat level Eye Screening Camps

**570+**

Students received eye-screening. A total of 13 students were provide spectacles.

**1,000**

Cataract surgeries were performed free of cost

## COVID-19 Care

- 1,229 COVID-19 Awareness Camps conducted
- 208,161 masks distributed
- 256 Oxygen Cylinders and 262 Oxygen concentrators donated
- 7,161 litres of sodium hypochlorite sprayed



## Social Reforms

Raising awareness against social evils like exploitation, inequality, trafficking in the remote corners of India, etc., has been our unrelenting battle for decades. With the support of community and local bodies, we organised awareness campaigns on social issues such as child labour, child marriage, women abuse, dowry and illiteracy. We also came to the aid of people during disasters with our relief programmes. The lack of financial literacy means rural people, especially women, never learn how to earn or manage money. We address these issues through financial literacy programmes and empower rural communities, especially women, through Self-help Groups, teaching them fundamental concepts of financial literacy and income generation.

Some of the key social reform initiatives carried out during FY2021-22 and number of beneficiaries are shown in the table:

Initiatives	Number of Beneficiaries (FY2021-22)
Child trafficking	3
Supported people in Disaster relief	3,379
Blanket distribution	7,544

## AFFORDABLE SANITARY PAD MANUFACTURING UNIT

In rural settings, people are unaware of sanitation and best hygiene practices and discussions on menstruation is still a taboo. Lack of access to sanitary pads results in the use of the unsafe alternatives which may be detrimental to women's health. Many adolescent girls miss 5 days of school per month and about 23% girls drop out of schools after they start menstruating.

To tackle this, our theory of change model adopted a three-pronged approach at Gare Palma:

- Social mobilisation, education & awareness regarding good menstrual hygiene practices.
- Creating in-house infrastructure to fulfill the demand of sanitary napkins.
- Supplying affordable sanitary napkins to the underprivileged sections of society.



Local women were trained to manufacture and distribute sanitary pads and were provided with necessary infrastructure to set up sanitary pad manufacturing units.

### Outcome of the project

We were successful in creating awareness about good menstrual hygiene practices and break the taboo associated with it.

**10**

Women completed the training

**3,200**

Pads (400 packets) produced and distributed

# Social and Relationship Capital

## Sustainable Livelihood

Our interventions in skill development and sustainable livelihood seek to equip locals with crucial skills for financial independence.

During FY2021-22, we initiated various programmes actualised through three intervention areas:

- Creation of livelihood opportunities and provision of employability skills including farmer training programmes and technical skill development programmes
- Enhancing water availability through integrated watershed management
- Construction of good quality, reliable and resilient infrastructure, and ensuring access to safe and affordable housing facilities

A significant quantum of our actions is aimed at nurturing grassroots entrepreneurship in rural margins, with women and farmers at the forefront of economic activities.

1,513 people received Vocational Job-Oriented Skill Training

1,813 SHGs with 23,214 members provided with financial literacy, managerial and conceptual training

3,468 farmers were provided agricultural tools, seeds, fertiliser, and insecticides

2,253 youths received technical skill training

346 farmer meetings conducted with 5,720 farmers in attendance

48,779 cattle were immunised in veterinary camps



Hindalco is generating livelihoods and restoring the dying art form of Kosa silk by training women in Raigarh

## REJUVENATING A DECLINING CLASSIC - BUILDING KOSA INTO A GLOBAL SILK HANDLOOM BRAND



Hindalco's CSR initiative to establish a social enterprise and build a premium silk handloom brand is in full swing. This year we set up 'Kosala Livelihood and Social Foundation', aimed at generating sustainable livelihood opportunities for reelers, weavers and artisans. We were able to generate a total revenue of ₹45 Lakh from this project for FY2021-22, generating sustainable livelihood opportunities

for 110 beneficiaries (reelers, weavers and artisans), with an income of ₹10 Lakhs. We also trained 46 women as reelers under this project. We have onboarded design and market linkage partners for the operations. We are further aiming to mobilise more artisans, firming up the organisation on the ground, and launching Kosala as a global brand.

## SUSTAINABLE LIVELIHOOD OPPORTUNITIES THROUGH DUCK FARMING AND AQUACULTURE TO LOCAL COMMUNITIES

Water harvesting areas are mandated for every restored mine site. To use these water bodies optimally, livelihood interventions suitable for the local communities were planned. This is an initiative towards livelihood generation carried out at Bagru mines, Jharkhand. In this project, exhausted mining pits are utilised as water harvesting structures. Dump water and surface run-off during monsoon is channelised into these structures. In this way, these pits get converted into ponds which are used to practice pisciculture. We have established bamboo cage and nursery for fingerlings, and a duck house to protect them during early stages of growth.

Under this project we imparted training to 10-12 farmers on scientific pisciculture. We also provided training on duck rearing to a self-help group 'Binko-Sangi Mahila Mandal' comprising 12 women. We helped them engage in the fish trade to earn their livelihood.

Initially, we invested ₹23 Lakhs but now the project is self-sustainable and solely handled by the SHG with technical guidance and support from Hindalco.



## #WADI (HARELI)- BIODIVERSITY BENEFITS ALL

Wadi in Gujarati means an orchard. Wadi model is a tried and tested way to promote sustainable tribal livelihood. Tribal economies tend to be primarily subsistence-oriented and are based on a combination of agriculture, forestry and wage labour. Although tribal populations are mainly dependent on agriculture, the collection of forest produce plays an important role in household consumption and income generation. Besides this, there are other challenges faced by tribal populations at the local level. Local farmers are usually

restricted majorly to one/two crops of rice while Orchard/Horticulture practices are restricted mostly to large farmers. Small/marginal holders are not yet introduced to or are fully aware of the concept of crop diversification/integrated farming.

To overcome some of the aforementioned challenges, we implemented Wadi model to develop sustainable livelihood opportunities for participating tribal communities through remunerative self-employment and prevent migration.

Till March 2022, 200 Wadis were initiated and pre-plantation work was completed. A total of 20 SHGs have been oriented to and mobilised for training in off farm trades (vermi, poultry, goatery, vegetable farming). Considering the effective project outcome, we plan to initiate its next phase, which shall include activities such as second batch of plantation, formation of new SHGs, development of infrastructure (irrigation and fencing) and providing training in non-farming activities.



# Social and Relationship Capital

## VERMICOMPOSTING AND MUSHROOM CULTIVATION- SUSTAINABLE PRACTICES FOR PRODUCING HIGH VALUE CROPS



make vermicompost and manage the enterprise through sales and record keeping. Over time, seven more SHGs were formed. All these SHGs were brought together under 'Sangam Kechua Khad Utpadan Samiti', a larger people's organisation. This helped to ensure maximum profit and negotiation power to the organisation.

Currently, more than 80 women are practicing the trade and their annual production of vermicompost is more than 8,000 MT. The annual turnover of the samiti from the 'black gold' is around ₹55 Lakh. This project assured sustainable livelihood to 80 women and created awareness among local farmers to use vermicompost over chemical fertilisers. Now, the project is self-sustained and efficiently managed by the SHG members.

We also trained the local women on earning livelihood through mushroom cultivation in partnership with SRI, Ranchi. 12 members of the "Ujala Mahila Samuh" of Bandhi village have started the production of oyster mushrooms. Apart from training, we provided infrastructure for the production unit. During first cycle of project, we provided them with mushroom spawns, required substrate and pesticides. Now each member is earning around ₹5,000 per crop.

The local communities near Bagru mines have limited land-based livelihood options. The agricultural produce stays limited to a single crop in the kharif season. Chemical fertilisers are used by the local farmers, thus deteriorating and contaminating the soil. We found that there was a need to make the local farmers aware of the benefits of organic means of cultivation and farming.

In 2011, a single vermicompost unit was established by Hindalco near the Bagru mines area. A Self-Help Group (SHG) by the name of Jai Sarna Mahila Mandal from Jamunatoli Village, comprising 11 women, was trained to

## Infrastructure Development

Good infrastructure is the foundation for economic activity and inclusive growth. Our goal of facilitating sustainable development among rural communities is linked to enhancement and development of rural infrastructure.

Thus, we have taken up critical infrastructure development projects in areas where we operate. This includes construction of roads to improve connectivity to the nearby market or hospitals, watershed development and irrigation support, ponds, schools and hospitals, community halls/kitchen, repairs/maintenance of places of heritage, sports and recreation centers, etc.



Water is one of the most precious natural resources on our Planet so we aim to make our operation water positive through various infrastructural measures for storage, recycle, reuse of water for the benefit of the local community. In this process we have constructed/renovated over 133 check dams, 169 ponds, 2 canals, 4 reservoirs, 13 water harvesting tanks and 60 trench clusters. Spread across 5 states, these initiatives have helped to irrigate more than 10,000 acres of land belonging to around 10,000 farmers. Additionally, more than 5,700 families are getting water for daily use through these measures. We have been able to store 3.1 Million cubic metres of water through various watershed development initiatives across our units.



Rainwater harvesting pond at Kathautia

**15**

Roads constructed

**1**

Place of heritage repaired/ maintained

**BUILT OVER 337**

rainwater harvesting structures till now

## SHAPING THE FUTURE OF WATER- RAINWATER HARVESTING



Our Samri mines, located in Chhattisgarh, is in a water scarce zone. Conservation of groundwater is a major worry for local communities. We have taken up a project to achieve water positivity in Samri bauxite mines with an aim of giving back more water to the environment and the community than we take.

As an innovative way to involve the community and fulfill their requirements, we have built Water ATMs. Currently, 3 drinking water ATMs built by us have been handed over to the community. In the next four years, we aim to install two more ATMs benefiting local communities and our contractual employees.

## Fostering Relationship with Customers

Business longevity relies on customer satisfaction and we serve a global customer base through operations spread across our 50 manufacturing units. Regular interactions with customers help us upgrade our products and processes to meet their dynamic needs and requirements. We continuously work to develop safe and sustainable products with a promise to deliver superior quality and unmatched experience. What differentiates us is our focus on value co-creation through solution-driven approach that transcends product supply, identifying customers' implicit and explicit needs.

Our multidimensional approach towards customer centricity has helped us deliver enhanced customer experience across our value chain. During the reporting period, there were no complaints received concerning breaches of customer privacy and losses of customer data.

# Social and Relationship Capital

Market served (Aluminium and Copper)			
Automotive and transport	Defence	Industrial application	Consumer durables
Building and Construction	Electrical and Electronics	Pharmaceuticals, beverage cans and packaging	Railways
Enhancing customer experience			
Geographies			

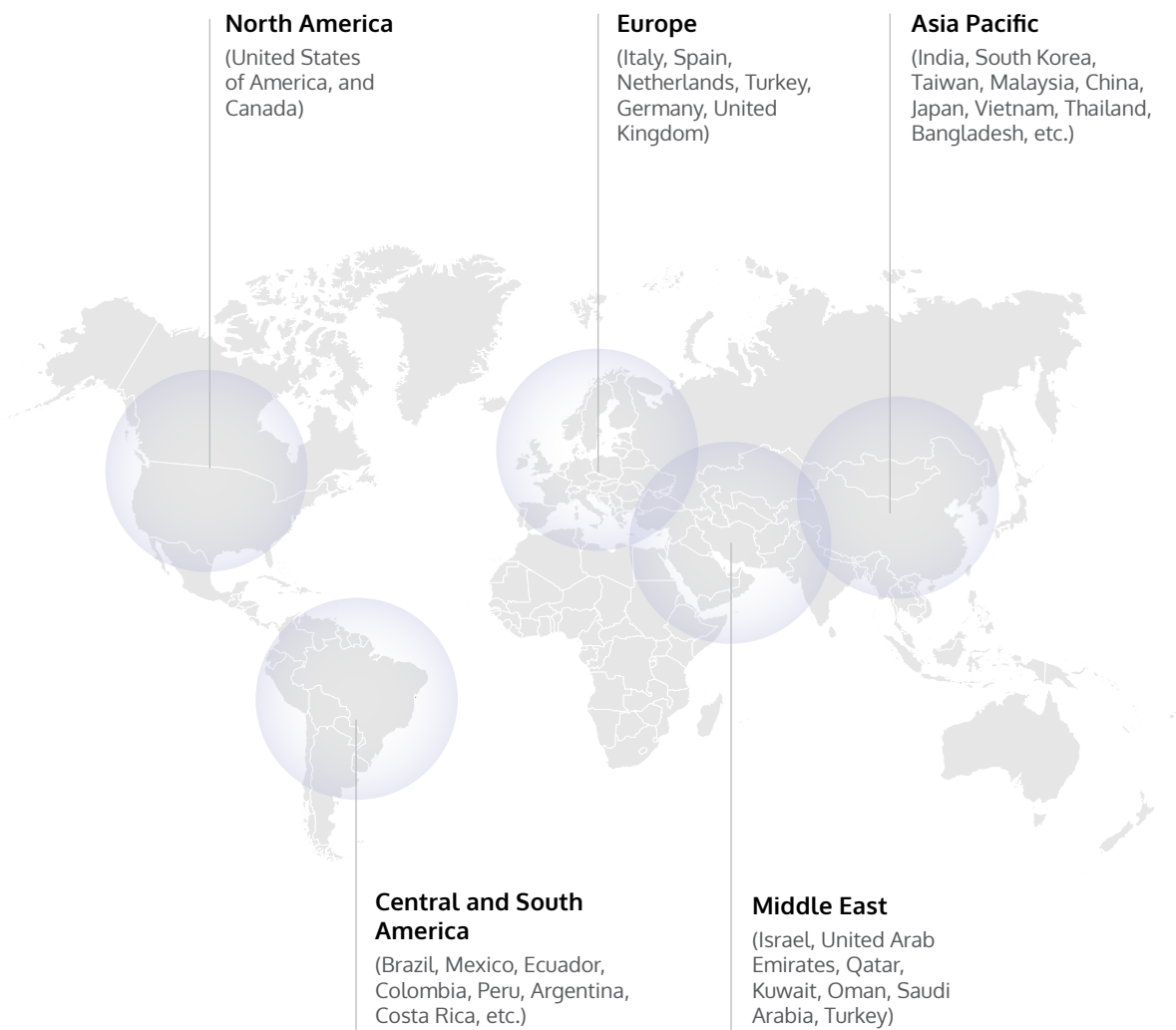

Hindalco has developed a range of lightweight commercial vehicles

## Aluminium Business - Key Customers

At Hindalco, we have built a strong customer base through our diverse aluminium offerings.

### Market Served

**Automotive and transport:** Used in automobile components such as brakes, transmission, suspension, Noise Vibration Harness, Steering Knuckle, Truck body fabrication cooling and exhaust systems, automobile heat exchangers and registration plates, structural, and decorative beadings.

**Building and construction:** Used in roofing, doors and windows, facades, formwork, structural applications, ceilings, grills, hardware, shutters, ladders, etc. It is also used in building and construction as it is resistant to corrosion.

**Defence:** Used for assault bridges, main battle tanks, missiles, weaponry systems, boats, etc.

**Electricals and electronics:** Used in power generation and transmission, cables and conductors, lamp caps, cable wraps, marine applications, light reflectors, heat sinks, solar panels, insulation etc.

**Industrial applications:** Used in textile spindles, hydraulic pumps, actuators and cylinders to valves, industrial machinery components, printing etc.

**Pharmaceuticals and packaging:** Used in various packaging applications like can body, closure caps, kitchen foils, tagger foil, pharmaceutical etc.

**Consumer durables:** Used in pressure cookers, cookware, air conditioners, fans, refrigerators etc.

**Commercial vehicle offerings:** Light weighting markers solutions in the form of aluminium alloy CV bodies such as articulated semi-trailers, truck bulkers, last mile e-mobility cargo boxes and railway freight wagon super structures.

**Personal mobility:** Components like bus bars, handlebars, frames and battery boxes.

## Aluminium Offerings

### Primary Applications

- Ingots
- EC wire rods
- Billets

### Transport solutions

- Light weighting applications and solutions in V and personal mobility segments

### Extrusion Applications

- Automotive
- Industrial machinery
- Defence
- White goods (used in cookware, ladders, mixer grinder parts)
- Electronics (used in light reflectors, heat sinks, solar panels, insulation)
- Constructions

### Flat-rolled Applications

- ACP stocks
- Circles (used in pressure cookers, non-stick cookware)
- Closure stocks
- Clad and Finstock
- Foil stock
- Litho stocks
- Hard alloys
- Building Sheets (used in residential roofing, false ceilings, etc.)
- General engineering products

### Foil Applications

- Flexible Packaging (Aseptic/Tetra pack, food, tobacco, personal care)
- Pharmaceutical
- House foil/Semi Rigid containers





## Copper Business - Key Customers

Our range of copper products serve a large base of customers including:

### Copper Offerings

#### Power Industry

Key offerings include:

- Conductors for transformer
- Generators and power equipment
- House wire cable and power cable

#### Automotive Industry

It includes following offerings:

- Wiring Harness
- Casting Components
- Motors

#### Electronics

Manufacturers of:

- Specialised wires
- Copper foil
- Circuit boards

#### Consumer Goods

It includes:

- Winding Wires
- Cables or Home Appliances
- Pumps & Motors

#### Constructions

Manufacturers of products like:

- Piping
- Earthing
- Plumbing
- Building wires

### Market Served

**Automotive and Transport:** High purity copper wire harness systems used to carry the current from the battery throughout the vehicle which includes the lights, central locking, on-board computers, satellite navigation systems, etc.

**Electrical Equipment:** Used in cables, transformers, motors, busbars, alternators, generators, as well as in home applications such as used in heat exchangers of air conditioners and refrigerators, etc.

**Railways:** Used in pantographs, switchgear, braking systems, motor windings, commutator bars, large and small service stations, copper is used extensively in signalling systems.

**Wire and Cable:** LME grade copper and cathode, continuous cast copper rods of various sizes, and precious metals such as gold and silver. Birla Copper and Birla Copper II are well-known in domestic and international markets for their high purity and constant quality.

## Novelis - Key Customer

Novelis operates integrated and technically advanced rolling and recycling facilities across North America, South America, Europe and Asia. Novelis' hallmark is delivering sustainable and innovative manufacturing solutions, with key customer segments including automotive, aerospace, beverage can and specialties industries.

### Novelis Offerings

- Aluminium sheet and plate material for fuselage and wing structure components
- Automotive Aluminium sheet
- Lightweight electric vehicle battery enclosure
- Producer of aluminium beverage can sheet
- Recycler of used beverage cans.
- Novelis Specialty Aluminium applications in-
  - Architecture and Construction
  - Food and Pharmaceutical
  - Signage and Printing
  - Transportation
  - Commercial and Consumer

### Market Served

**Aerospace:** Aluminium offers high strength-to-weight ratio, energy efficiency, and high tolerance to extreme temperatures - making it ideal material for the manufacturing of aircraft.

**Automotive:** Novelis's Advanz™ and Fusion™ product portfolio includes high-performing alloys ideal for inner applications such as decklid and door inner and other closure inner panels.

Novelis is the leader in auto body sheets used for making BIW light, durable vehicles.

**Beverage cans:** Produce distinctive Aluminium bottles, which offer the same portability, light-weight, and recyclability as Aluminium cans, but with the added benefit of being re-closeable. Also, leading buyer and recycler of used beverage cans (UBC's) globally

**Specialities:** Novelis offers a wide range of products under specialities aluminium such as AL:sust™, G77Ac, SSL BF, etc.

### MIXED - MATERIAL VEHICLE PRODUCTION



Aluminium is a versatile element and has different applications in vehicle body and closures, across different vehicle types. Design engineers continue to find new ways for light weighting. As adoption of aluminum grows across different applications, multi-material architectures are now a common approach used by vehicle manufacturers to achieve a balance between weight reduction

and cost for more price sensitive segment which still requires efficiency improvements. As aluminum can be effectively alloyed with other metals, it is an excellent choice for engineers constructing multi-material body structures. In principle almost every car on the road today is already a mixed-material architecture as engineers have determined that not all parts of the vehicle body need to handle the same levels of crash and structural performance. This approach has evolved in sophistication and now there are extensive examples where both aluminum and different types of metals and composites can be found in the same structure. Novelis has deep expertise in the application of aluminum alloys in combination

with various other sheet metals and is uniquely positioned to provide technical guidance to automakers from design to production feasibility. The combination of extensive metallurgical know-how and automotive centric testing and engineering capabilities, permits Novelis to intimately guide the industry with questions around corrosion and joining practices.

Novelis' products and joining know-how also make it possible to integrate aluminum sheet into a mixed-material vehicle without requiring a significant investment in new manufacturing equipment.

# Social and Relationship Capital

## OXYCARE SYSTEM UNDER ATMANIRBHAR BHARAT

To combat the shortage of medical oxygen across the country, we collaborated with a multinational automotive company to provide aluminium extrusions for oxygen cylinders.

Aluminium cylinders have the advantage of being lightweight and portable. A sum of ₹350 Crore was granted from the PM Cares Fund for the Oxcare system under which one Lakh cylinders were manufactured. These will be supplied all over India to recognised hospitals shortlisted by the government.

Actions (CAPA) in the system before closing the ticket, ensuring proper resolution. We take measures to make sure that customers don't face the same issues in the future. During the reporting year, we did not receive a single complaint on breach of customer privacy and loss of customer data.

## Net Promoter Score

(%)

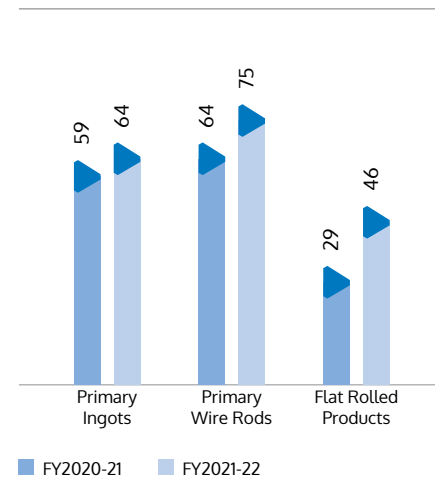

minimise the use of restricted chemicals in the manufacturing of the product. For Aluminium foil, we adhere to less than 100 ppm of heavy metals as mandated under the REACH regulation. During the year, there was no reported incident of non-compliance on product health and safety norms and standards. Additionally, during FY2021-22, there were no incidents of non-compliance concerning marketing communications, product and service information or labelling. All our products comply with local and international regulations on product and service information and labelling. Moreover, all our products and services categories undergo health and safety impact assessment.

Our Eternia range of products (aluminium doors and windows) and Everlast roofing solutions received the international GreenPro Certification/Eco Label. This label is a testament to our actions in alloy innovation and product design to create sustainable spaces and our contribution towards enhancing the performance of Green Buildings. Our transport application solutions have gone through rigorous validation from certifying bodies such as ARAI and ICAT.

Our unit at Mouda has been certified by Aluminium Stewardship Institute (ASI), demonstrating our commitment to act responsibly in the production and processing of aluminium products. We are planning for other plants to become ASI certified as well. During the year, we also received awards from CII and Frost & Sullivan for our contribution towards environment and sustainability.

## Sustainable Value Chain

Our suppliers are integral to our business and spread across the globe. We encourage them to imbibe our corporate values, demonstrate good corporate citizenship and follow sustainable practices through our Supplier Code of Conduct.

While we meet much of our raw material requirements from India, we have a large supplier network across 41 other countries including China, US, Mexico, Italy, Singapore, Dubai, Armenia, Japan, Togo, Chile, Peru, Brazil, Canada, Australia, Indonesia, South Africa, etc. Our suppliers undergo screening to be assessed on parameters such as price competitiveness, quality, response time and ESG criteria such as health and safety, environmental standards, working conditions, labour rights etc. Based on the outcome of the assessment, each supplier is rated and placed in one of the following categories:

- i) **Identified Vendors:** Those willing to do business with our Company.
- ii) **Empanelled Vendors:** Those eligible to undertake trial orders.
- iii) **Approved Vendors:** Those who are finally selected and approved post-performance evaluation.

Our 'critical suppliers' are those who provide- critical components for our operations, constitute a high volume of procurement spend or are non-substitutable. Suppliers who make up 90% of the allocated total spend are classified as critical. Out of total Tier-1 suppliers, we identified 119 suppliers as 'critical'. Our total procurement spent for the current reporting period is ₹51,761 Crore for Hindalco on basis of order placement.

## Our Supplier Network for Hindalco

Type of Supplier	Absolute Number of Suppliers	Amount Spend ₹ (Crore)	No. of Supplier Assessed	No. of Supplier Assessed through Comprehensive Methods	Share of Total Procurement Spend
Total Tier-1 Suppliers	10,245	51,761	10,245	169	100%
Critical Tier-1 Suppliers	119	46,597	119	47	90%
Critical non-Tier-1 Suppliers	-	-	-	-	-

## Breakdown of Total Procurement Spend during the FY2021-22 for Hindalco

Procurement spend by Geography (%)

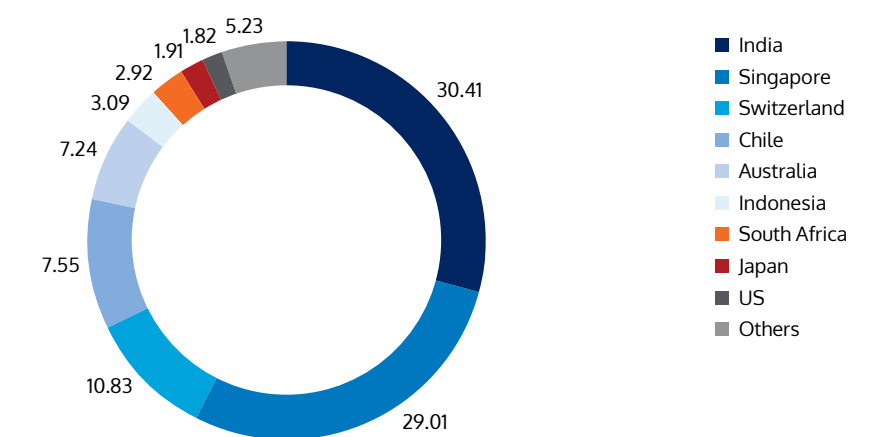

## Customer Satisfaction

We implement a mix of Bottom-Up and Top-Down approach to gain a holistic understanding of customer perceptions regarding our products and services. Our customer-centric approach has led us to adopt a Net Promoter Score (NPS) model over our previous Customer Satisfaction Model. We do a detailed cross functional analysis of customer feedback and try to assess customer perceptions in depth through the NPS survey. We plan appropriate actions to be taken for higher customer advocacy and satisfaction, identifying pain points in the customer experience through analysis of the NPS model results.

To ensure customer grievances get addressed in time and with quality, our team follows a time bound standard operating procedure of grievance redressal. Once a customer registers a grievance, it is logged in our Customer Relationship Management (CRM) system. We analyse the issue and provide Corrective and Preventive

## Product Safety and Quality

At Hindalco, we consider safe and reliable products as a fundamental part of our product designing and manufacturing process.

We serve Business to Business (B2B) and Business to Customer (B2C) markets, adhering to mandated standards. In our B2B model, we supply aluminium to cookware manufacturers which is certified "food grade" as per EN 602 and IS 21. We also provide test certificates to our B2B customers to assure quality and reliability of the delivered product. In the B2C model, we conform to BIS Standards 15392, Registration, Evaluation, Authorisation, and Restriction of Chemicals (REACH regulation of the European Union) and Restriction of Hazardous Substances (ROHS) directive. We ensure compliance with the quality requirements to



Jetty at Birla Copper, Dahej



# Social and Relationship Capital

## Supplier Code of Conduct

Our Supplier Code of Conduct (SCC) has been developed in line with global best practices on safety, health, environment, human rights, ethical and fair business practices. This is to ensure responsible sourcing and implementation of sustainable business practices throughout our value chain. All our suppliers are expected to adhere to the minimum employment age limit, as per applicable laws or regulation and comply with relevant International Labor Organisation (ILO) standards on human rights, as laid down in our SCC. Moreover, suppliers are asked to maintain and promote fundamental human rights and prohibit forced or compulsory labor.



### Key focus areas from our Supplier Code of Conduct

- Compliance with All Applicable Laws and Regulations
- Business Ethics
- Occupational Health and Safety
- Labour and Human Rights
- Anti-corruption/Bribery
- Verification of Supplier's Compliance
- Development of High Quality and Safe Products
- Fair Treatment to Employees and Suppliers
- Sustainable Practices

Our supply chain partners undergo periodic assessments to check whether they are conforming to the Supply Chain Code of Conduct. We also encourage our suppliers to develop their own sourcing policies and standards in line with international standards.

## Integrating ESG in Supply Chain Management

With the increased focus on ESG, it has become imperative for our business to identify potential and actual ESG risks which are material to our supply chain. We remain committed to comply with all applicable legislations, regulations, and codes of practices, including environment, health and safety laws, across our value chain. We expect our suppliers to maintain safe working conditions at their operations by continuously identifying, assessing, and reducing health and safety risk in compliance with our SCC. Suppliers are also encouraged to create awareness and provide training on risk precautions and emergency measures to their employees and contractors.

We comply with applicable labour laws in the geographies in which we operate. Our Human Rights Policy (HRP) and SCC outline the company's as well as suppliers' responsibility to protect fundamental rights of workers

and individuals. Compliance with these requirements is assessed at the time of supplier selection or assessment through our Vendor Evaluation Process. During the reporting period, we focussed on establishing business relationship with those suppliers who did not violate labour laws or caused any detrimental impact on the environment.

## Supplier Evaluation and Risk Assessment

Our formal supplier risk identification process helps us in evaluating suppliers during two stages – on-boarding and biennially for assessment of selected critical suppliers. Our suppliers are assessed on parameters such as health and safety, environment management, labour management and human rights, statutory compliance, financial attributes and market dependency. Based on risk assessment, each supplier receives a score which determines their risk rating and gives an overview of prevalent risks. About 25% weightage is given to ESG segment in the overall assessment of the suppliers.

Based on the score received in the vendor assessment process, rating is calculated for each supplier. Basis their rating, they are classified into high, medium or low risk. Low rating of supplier impacts their business



opportunity/relationship with us. During the FY2021-22, 19 % of total suppliers have been classified as high-risk. According to the most recent vendor assessment conducted in FY2018-19, 38% of our critical suppliers scored below 2.5 and we further aim to reduce such suppliers by 3% by FY2022-23.

Risk Rating	Category
Less than 2.5**	High Risk Supplier (Development Needed)
2.5 to 3.24	Moderate Risk Supplier (Acceptable-Action may still be required)
3.25 to 5.00	Low Risk Supplier

\*\* Suppliers categorised as high-risk stand to lose the opportunity to receive inquiries or business from Hindalco.

We are committed to provide the required training and support to all our critical Tier- 1 suppliers (with score less than 2.5), to help them improve their risk rating. Our target is to achieve significant improvement in our scores by 2024. For suppliers with a good score (over 4), we also plan to conduct physical and virtual audits. By 2024, our goal is to conduct due diligence of 100% of our critical suppliers, with whom we have had business relationship for last two years.

We also carry out risk evaluation of the entire supply chain. With the dynamic market conditions and growing presence of technology throughout the supply chain, risk assessment has become a crucial mechanism for the organisations to manage supplier side risks.

We have developed an enterprise risk register for the central procurement supply chain. In the risk register, we identified key risks associated with supply chain disruption, geopolitical logistics, infrastructure, financial, strategic and operational risk. We carry out a root cause analysis, identify Company objectives that the risk has a bearing on and assess the risk's likelihood and severity score. Based on the increasing order of scores, risk is categorised as Green, Yellow, Amber and Red. Post risk categorisation, we establish a mitigation plan to reduce risk score. Execution of the mitigation plan is evaluated every month.

During the reporting year, 156 suppliers were screened using environmental criteria and 299 suppliers were screened using social criteria. All of our new suppliers were screened using social and environmental criteria during vendor on-boarding. A total of 159 of our suppliers have undergone sustainability risk assessment in the last 3 years.

## Managing supply chain during pandemic

Due to COVID-19 induced lockdown and closure of state and country borders, we faced connectivity challenges within the supply chain. To ensure continuity of our operations, we proactively established connections with plant teams to understand and resolve their supply side concerns. Within ten days of lockdown, we were able to increase the inventory of key raw materials from 8 days to 15 days and broadened our vendor base from one key vendor to upto four vendors in certain cases. We developed indigenous sources for materials that were heavily dependent on imports and diversified our ALF3 (Aluminium Fluoride) supplies by procuring from Middle East and Mexico, thus reducing dependencies on China and Italy. The suppliers took risks for us by surrendering the clearance documents without getting payment. All this was possible because of the relationship of trust between Hindalco and its supply chain partners.

### EXTENDING A LIFELINE TO THE COMMUNITY AT RENUKOOT

At the peak of the second COVID-19 crisis, when Oxygen was needed to save the lives of COVID-19 affected patients, we identified that one of our previous gas suppliers had an oxygen plant in Anpara which was non-operational for last 7 years. We initiated and supported the restoration of the oxygen plant in collaboration with the oxygen plant owner, so that the acute shortage of oxygen could be addressed. Inter-departmental teams were made, who worked day and night to execute the operation with continuous guidance from the plant head. With this joint effort, we managed to restart the oxygen plant in just 6 days.

The system started working in full swing, and approx. 300 oxygen cylinders were refilled on a daily basis. Anpara Gases has supplied oxygen cylinders to public and private hospitals in Mirzapur, Shaktinagar and Robertsganj. It supplied oxygen to hospitals and industries based in Singrauli (Madhya Pradesh) as well. The revival of this plant saved lives and was a boon to the community during this difficult time.



# Major Awards and Recognitions



## Corporate

Hindalco ranked as 'World's Most Sustainable Aluminium Company' in the S&P Dow Jones Sustainability Indices (DJSI) Corporate Sustainability Assessment (CSA) rankings 2021



Hindalco won 'Sustainable Corporate of the Year Award – 1st Runner up' by Frost & Sullivan and TERI Sustainability 4.0 Awards 2021



Hindalco was certified as a 'Great Place to Work' by the Great Place to Work Institute in 2021 in recognition of Hindalco's efforts towards building a building a culture of High-Trust and High Performance.

ICAI- SRSB silver shield for integrated report in the new entrants category.

## Utkal

Utkal won Sita Ram Rungta Social Awareness Award

Utkal won 2nd Runners Up award at India Green Manufacturing Challenge 2021

## Renukoot

Renukoot won 'Dream Companies to Work for' at HR Excellence Awards 2022

Renukoot wins SEEM National Energy Management Award in Platinum category

## Hirakud

Hirakud won a Special Award for Energy Conservation at India Green Manufacturing Challenge 2021

## Aditya

Aditya won a Special Award for Energy Conservation at India Green Manufacturing Challenge 2021

Aditya won Fame Excellence Award in Platinum category for 'Project Saksham'

CII Award under waste - 3R category

## Belagavi

CII Award under waste - 3R category



# GRI Content Index

## Statement of use

Hindalco Industries Limited has reported in accordance with the GRI Standards for the period 01 April 2021 to 31 March 2022.

## GRI 1 used

GRI 1: Foundation 2021

GRI Standard/ Other Source	Disclosure	Location	Omission			GRI Sector Standard Ref. No.
			Requirement(s) Omitted	Reason	Explanation	
<b>General disclosures</b>						
GRI 2: General Disclosures 2021	2-1 Organisational details	10-13 (Our Business at Glance)	-	-	-	-
	2-2 Entities included in the organisation's sustainability reporting	7 (About the report)	-	-	-	-
	2-3 Reporting period, frequency and contact point	7 (About the report)	-	-	-	-
	2-4 Restatements of information	120 (Natural Capital)	-	-	-	-
	2-5 External assurance	Independent assurance statement on Integrated Report	-	-	-	-
	2-6 Activities, value chain and other business relationships	12, 13 (Our Business at Glance)	-	-	-	-
	2-7 Employees	74 (Organisation effectiveness- Employee Strength)	-	-	-	-
	2-8 Workers who are not employees	74 (Organisation effectiveness- Employee Strength)	-	-	-	-
	2-9 Governance structure and composition	16-17 (Leadership Team) 18-19 (Board of Directors)	-	-	-	-
	2-10 Nomination and selection of the highest governance body	Coprorate Governance Report	-	-	-	-
	2-11 Chair of the highest governance body	Coprorate Governance Report	-	-	-	-
	2-12 Role of the highest governance body in overseeing the management of impacts	Coprorate Governance Report	-	-	-	-
	2-13 Delegation of responsibility for managing impacts	Coprorate Governance Report	-	-	-	-
	2-14 Role of the highest governance body in sustainability reporting	102 (Environment Management)	-	-	-	-
	2-15 Conflicts of interest	Coprorate Governance Report	-	-	-	-
	2-16 Communication of critical concerns	Coprorate Governance Report	-	-	-	-
	2-17 Collective knowledge of the highest governance body	Coprorate Governance Report	-	-	-	-
	2-18 Evaluation of the performance of the highest governance body	Coprorate Governance Report	-	-	-	-



# GRI Content Index

GRI Standard/ Other Source	Disclosure	Location	Omission			GRI Sector Standard Ref. No.
			Requirement(s) Omitted	Reason	Explanation	
	2-19 Remuneration policies	HIL Remuneration Policy	-	-	-	-
	2-20 Process to determine remuneration	HIL Remuneration Policy	-	-	-	-
	2-21 Annual total compensation ratio	Details of remuneration (Annexure III)	-	-	-	-
	2-22 Statement on sustainable development strategy	26 (Message from Managing Director)	-	-	-	-
	2-23 Policy commitments	85 (Human Rights), Human Rights Policy	-	-	-	-
	2-24 Embedding policy commitments	85 (Human rights)	-	-	-	-
	2-25 Processes to remediate negative impacts	Corporate Governance Report 42, 43 (Stakeholder engagement)	-	-	-	-
	2-26 Mechanisms for seeking advice and raising concerns	Corporate Governance Report	-	-	-	-
	2-27 Compliance with laws and regulations	102 (Environment Management)	-	-	-	-
	2-28 Membership associations	15 (Our key associations)	-	-	-	-
	2-29 Approach to stakeholder engagement	42,43 (Stakeholder engagement)	-	-	-	-
	2-30 Collective bargaining agreements	83 (Employee well-being and Human rights)	-	-	-	-
<b>Material topics</b>						
GRI 3: Material Topics 2021	3-1 Process to determine material topics	42-45 (Stakeholder engagement, Materiality Assessment)	-	-	-	-
	3-2 List of material topics	44 (Materiality Assessment)	-	-	-	-
<b>Energy &amp; GHG Emissions Management</b>						
GRI 3: Material Topics 2021	3-3 Management of material topics	103 (Energy Consumption) 105 (Emission Management)	-	-	-	-
GRI 302: Energy 2016	302-1 Energy consumption within the organisation	103 (Energy Consumption)	-	-	-	-
	302-2 Energy consumption outside of the organisation	104 (Energy Consumption)	-	-	-	-
	302-3 Energy intensity	104 (Energy Consumption- Energy Intensity)	-	-	-	-
	302-4 Reduction of energy consumption	109 (Initiatives for Energy and Emission Reduction)	-	-	-	-

GRI Standard/ Other Source	Disclosure	Location	Omission			GRI Sector Standard Ref. No.
			Requirement(s) Omitted	Reason	Explanation	
GRI 305: Emissions 2016	305-1 Direct (Scope 1) GHG emissions	105 (Emission Management)	-	-	-	-
	305-2 Energy indirect (Scope 2) GHG emissions	105 (Emission Management)	-	-	-	-
	305-3 Other indirect (Scope 3) GHG emissions	105 (Emission Management)	-	-	-	-
	305-4 GHG emissions intensity	106 (Emission Management- Emission Intensity)	-	-	-	-
	305-5 Reduction of GHG emissions	109 (Initiatives for Energy and Emission Reduction)	-	-	-	-
	305-6 Emissions of ozone-depleting substances (ODS)	109 (Ozone Depleting Substance)	-	-	-	-
	305-7 Nitrogen oxides (NOx), sulfur oxides (SOx), and other significant air emissions	106 (Stack Emissions)	-	-	-	-
<b>Water Management</b>						
GRI 3: Material Topics 2021	3-3 Management of material topics	118 (Securing water)	-	-	-	-
GRI 303: Water and Effluents 2018	303-1 Interactions with water as a shared resource	118 (Securing water)	-	-	-	-
	303-2 Management of water discharge-related impacts	122 (Securing Water- Effluent Management)	-	-	-	-
	303-3 Water withdrawal	119 (Securing Water- Water withdrawal)	-	-	-	-
	303-4 Water discharge	122 (Securing Water- Effluent Management)	-	-	-	-
	303-5 Water consumption	119 (Securing Water- Water consumption)	-	-	-	-
<b>Occupational health and safety</b>						
GRI 3: Material Topics 2021	3-3 Management of material topics	86 (Occupation Health and Safety)	-	-	-	-
GRI 403: Occupational Health and Safety 2018	403-1 Occupational health and safety management system	86 (Occupation Health and Safety)	-	-	-	-
	403-2 Hazard identification, risk assessment, and incident investigation	89 (Safety Risk Assessment)	-	-	-	-
	403-3 Occupational health services	89 (Occupational Health Services)	-	-	-	-
	403-4 Worker participation, consultation, and communication on occupational health and safety	87 (Safety Training) 89 (Safety Risk Assessment)	-	-	-	-
	403-5 Worker training on occupational health and safety	87 (Safety Training)	-	-	-	-

# GRI Content Index

GRI Standard/ Other Source	Disclosure	Location	Omission			GRI Sector Standard Ref. No.
			Requirement(s) Omitted	Reason	Explanation	
	403-6 Promotion of worker health	89 (Occupational Health Services)	-	-	-	-
	403-7 Prevention and mitigation of occupational health and safety impacts directly linked by business relationships	89 (Occupational Health Services) 89 (Safety Risk Assessment)	-	-	-	-
	403-8 Workers covered by an occupational health and safety management system	87 (Safety Training) 89 (Occupational Health Services) 89 (Safety Risk Assessment)	-	-	-	-
	403-9 Work-related injuries	88 (Work-related injuries)	-	-	-	-
	403-10 Work-related ill health	88 (Work-related injuries)	-	-	-	-
<b>Ethics and Integrity</b>						
GRI 3: Material Topics 2021	3-3 Management of material topics	Corporate Governance Report	-	-	-	-
GRI 205: Anti-corruption 2016	205-1 Operations assessed for risks related to corruption	Corporate Governance Report	-	-	-	-
	205-2 Communication and training about anti-corruption policies and procedures	Corporate Governance Report	-	-	-	-
	205-3 Confirmed incidents of corruption and actions taken	Corporate Governance Report	-	-	-	-
GRI 206: Anti-competitive Behavior 2016	206-1 Legal actions for anti-competitive behavior, anti-trust, and monopoly practices	Corporate Governance Report	-	-	-	-
GRI 415: Public Policy 2016	415-1 Political contributions	Corporate Governance Report	-	-	-	-
<b>Employee well-being</b>						
GRI 3: Material Topics 2021	3-3 Management of material topics	70 (Organisation Effectiveness)	-	-	-	-
GRI 401: Employment 2016	401-1 New employee hires and employee turnover	75 (Organisation Effectiveness- Employee Strength)	-	-	-	-
	401-2 Benefits provided to full-time employees that are not provided to temporary or part-time employees	83 (Employee Well-Being and Human Rights)	-	-	-	-
	401-3 Parental leave	84 (Employee Well-Being and Human Rights)	-	-	-	-
GRI 402: Labor/Management Relations 2016	402-1 Minimum notice periods regarding operational changes	84 (Employee Well-Being and Human Rights)	-	-	-	-
GRI 404: Training and Education 2016	404-1 Average hours of training per year per employee	78 (Learning and Development)	-	-	-	-
	404-2 Programs for upgrading employee skills and transition assistance programs	78 (Learning and Development)	-	-	-	-

GRI Standard/ Other Source	Disclosure	Location	Omission			GRI Sector Standard Ref. No.
			Requirement(s) Omitted	Reason	Explanation	
	404-3 Percentage of employees receiving regular performance and career development reviews	76 (Performance Evaluation)	-	-	-	-
GRI 405: Diversity and Equal Opportunity 2016	405-1 Diversity of governance bodies and employees	74 (Organisation effectiveness- Employee Strength)	-	-	-	-
	405-2 Ratio of basic salary and remuneration of women to men	84 (Employee Well-Being and Human Rights)	-	-	-	-
GRI 406: Non-discrimination 2016	406-1 Incidents of discrimination and corrective actions taken	81 (Diversity and Inclusion)	-	-	-	-
GRI 407: Freedom of Association and Collective Bargaining 2016	407-1 Operations and suppliers in which the right to freedom of association and collective bargaining may be at risk	83 (Employee Well-Being and Human Rights)	-	-	-	-
<b>Community Relations</b>						
GRI 3: Material Topics 2021	3-3 Management of material topics	133 (Engage, Uplift & Empower- Investing in communities)	-	-	-	-
GRI 413: Local Communities 2016	413-1 Operations with local community engagement, impact assessments, and development programs	133 (Engage, Uplift & Empower- Investing in communities)	-	-	-	-
	413-2 Operations with significant actual and potential negative impacts on local communities	133 (Engage, Uplift & Empower- Investing in communities)	-	-	-	-
<b>Economic performance</b>						
GRI 3: Material Topics 2021	3-3 Management of material topics	47 (Financial Capital)	-	-	-	-
GRI 201: Economic Performance 2016	201-1 Direct economic value generated and distributed	48 (Financial Capital- Economic Value Creation)	-	-	-	-
	201-2 Financial implications and other risks and opportunities due to climate change	35 (Building Resilience) 102 (Towards Decarbonisation)	-	-	-	-
	201-3 Defined benefit plan obligations and other retirement plans	Corporate Governance Report	-	-	-	-
	201-4 Financial assistance received from government	Financial Statements (Consolidated Statement of Cash Flows)	-	-	-	-
GRI 203: Indirect Economic Impacts 2016	203-1 Infrastructure investments and services supported	53 (Financial Capital- Capacity expansion)	-	-	-	-
	203-2 Significant indirect economic impacts	133 (Engage, Uplift & Empower- Investing in communities)	-	-	-	-



# GRI Content Index

GRI Standard/ Other Source	Disclosure	Location	Omission			GRI Sector Standard Ref. No.
			Requirement(s) Omitted	Reason	Explanation	
<b>Security and Human Rights</b>						
GRI 3: Material Topics 2021	3-3 Management of material topics	85 (Human Rights) 147 (Supplier code of conduct)	-	-	-	-
GRI 408: Child Labor 2016	408-1 Operations and suppliers at significant risk for incidents of child labor	85 (Human Rights) 137 (Social Reforms) 148 (Supplier code of conduct)	-	-	-	-
GRI 409: Forced or Compulsory Labor 2016	409-1 Operations and suppliers at significant risk for incidents of forced or compulsory labor	137 (Social Reforms) 148 (Supplier code of conduct)	-	-	-	-
GRI 410: Security Practices 2016	410-1 Security personnel trained in human rights policies or procedures	85 (Human Rights)	-	-	-	-
GRI 411: Rights of Indigenous Peoples 2016	411-1 Incidents of violations involving rights of indigenous peoples	85 (Protecting Indigenous Communities)	-	-	-	-
<b>Waste</b>						
GRI 3: Material Topics 2021	3-3 Management of material topics	113 (Waste as a Resource)	-	-	-	-
GRI 306: Waste 2020	306-1 Waste generation and significant waste-related impacts	114, 115 (Waste as a Resource- Non-Hazardous waste and Hazardous waste)	-	-	-	-
	306-2 Management of significant waste-related impacts	114, 115 (Waste as a Resource- Non-Hazardous waste and Hazardous waste)	-	-	-	-
	306-3 Waste generated	114, 115 (Waste as a Resource- Non-Hazardous waste and Hazardous waste)	-	-	-	-
	306-4 Waste diverted from disposal	114, 115 (Waste as a Resource- Non-Hazardous waste and Hazardous waste)	-	-	-	-
	306-5 Waste directed to disposal	114, 115 (Waste as a Resource- Non-Hazardous waste and Hazardous waste)	-	-	-	-
<b>Materials</b>						
GRI 3: Material Topics 2021	3-3 Management of material topics	112 (Responsible Consumption)	-	-	-	-
GRI 301: Materials 2016	301-1 Materials used by weight or volume	112 (Responsible Consumption)	-	-	-	-
	301-2 Recycled input materials used	112 (Responsible Consumption)	-	-	-	-
	301-3 Reclaimed products and their packaging materials	112 (Responsible Consumption)	-	-	-	-

GRI Standard/ Other Source	Disclosure	Location	Omission			GRI Sector Standard Ref. No.
			Requirement(s) Omitted	Reason	Explanation	
<b>Customer health and safety</b>						
GRI 3: Material Topics 2021	3-3 Management of material topics	141 (Fostering Customer Relationship)	-	-	-	-
GRI 416: Customer Health and Safety 2016	416-1 Assessment of the health and safety impacts of product and service categories	146 (Product Safety and quality)	-	-	-	-
	416-2 Incidents of non-compliance concerning the health and safety impacts of products and services	146 (Product Safety and quality)	-	-	-	-
	416-3 Incidents of non-compliance concerning marketing communications	146 (Product Safety and quality)	-	-	-	-
GRI 417: Marketing and Labeling 2016	417-1 Requirements for product and service information and labeling	146 (Product Safety and quality)	-	-	-	-
	417-2 Incidents of non-compliance concerning product and service information and labeling	146 (Product Safety and quality)	-	-	-	-
	417-3 Incidents of non-compliance concerning marketing communications	146 (Product Safety and quality)	-	-	-	-
GRI 418: Customer Privacy 2016	418-1 Substantiated complaints concerning breaches of customer privacy and losses of customer data	146 (Customer Satisfaction)	-	-	-	-
<b>Procurement practices</b>						
GRI 3: Material Topics 2021	3-3 Management of material topics	146, 147 (Sustainable Value Chain)	-	-	-	-
GRI 204: Procurement Practices 2016	204-1 Proportion of spending on local suppliers	147 (Sustainable Value Chain)	-	-	-	-
GRI 308: Supplier Environmental Assessment 2016	308-1 New suppliers that were screened using environmental criteria	148, 149 (Supplier Evaluation and Risk Assessment)	-	-	-	-
	308-2 Negative environmental impacts in the supply chain and actions taken	148, 149 (Supplier Evaluation and Risk Assessment)	-	-	-	-
GRI 414: Supplier Social Assessment 2016	414-1 New suppliers that were screened using social criteria	148, 149 (Supplier Evaluation and Risk Assessment)	-	-	-	-
	414-2 Negative social impacts in the supply chain and actions taken	148, 149 (Supplier Evaluation and Risk Assessment)	-	-	-	-

# GRI Content Index

GRI Standard/ Other Source	Disclosure	Location	Omission			GRI Sector Standard Ref. No.
			Requirement(s) Omitted	Reason	Explanation	
<b>Biodiversity</b>						
GRI 3: Material Topics 2021	3-3 Management of material topics	126, 127 (Sustainable mining-Safeguarding biodiversity)	-	-	-	-
GRI 304: Biodiversity 2016	304-1 Operational sites owned, leased, managed in, or adjacent to, protected areas and areas of high biodiversity value outside protected areas	126 (Sustainable mining)	-	-	-	-
	304-2 Significant impacts of activities, products and services on biodiversity	126 (Sustainable mining)	-	-	-	-
	304-3 Habitats protected or restored	127, 128 (Sustainable mining-Safeguarding biodiversity)	-	-	-	-
	304-4 IUCN Red List species and national conservation list species with habitats in areas affected by operations	127 (Sustainable mining-Safeguarding biodiversity)	-	-	-	-
<b>Tax</b>						
GRI 3: Material Topics 2021	3-3 Management of material topics	Statutory Reports and Financial Statements	-	-	-	-
GRI 207: Tax 2019	207-1 Approach to tax	Statutory Reports and Financial Statements	-	-	-	-
	207-2 Tax governance, control, and risk management	Statutory Reports and Financial Statements	-	-	-	-
	207-3 Stakeholder engagement and management of concerns related to tax	Statutory Reports and Financial Statements	-	-	-	-
	207-4 Country-by-country reporting	Statutory Reports and Financial Statements	-	-	-	-

All our policies are available at <https://www.hindalco.com/investor-centre/policies>



# UNGC Principles

UNGC Principles	Description of the Principle	Section in Report	Page No.
Principle 1	Businesses should support and respect the protection of internationally proclaimed human rights.	Human Capital	85
Principle 2	Make sure that they are not complicit in human right abuses.	Human Capital	85
Principle 3	Business should uphold the freedom of association and the effective recognition of the right to collective bargaining	Human Capital	83
Principle 4	The elimination of all forms of forced and compulsory labour.	Human Capital	85, 148
Principle 5	The effective abolition of child labour	Human Capital	85, 137, 148
Principle 6	The elimination of discrimination in respect of employment and occupation.	Human Capital	70, 85
Principle 7	Business should support a precautionary approach to environmental challenges.	Natural Capital, Building Resilience	35-39, 101
Principle 8	Undertake initiatives to promote greater environmental responsibility.	Natural Capital	100
Principle 9	Encourage the development and diffusion of environmentally friendly technologies.	Intellectual Capital, Natural Capital	96, 97, 100
Principle 10	Business should work against corruption in all its forms, including extortion and bribery.	Corporate Governance	Corporate Governance





# Sustainable Development Goal

Sustainable Development Goal (SDG)	Section in the report	Page number
SDG 2 Zero Hunger	Social and Relationship Capital	133
SDG 3 Good health and wellbeing	Social and Relationship Capital	133
SDG 4 Quality Education	Human Capital Social and Relationship Capital	77, 134
SDG 5 Gender equality	Human Capital Social and Relationship Capital	74, 80, 81, 137
SDG 6 Clean Water and Sanitation	Natural Capital Social and Relationship Capital	118, 140, 141
SDG 7 Affordable and Clean Energy	Natural Capital	103
SDG 8 Decent work and Economic Growth	Financial Capital Manufactured Capital Human Capital Social and Relationship Capital	47, 63, 83, 138, 139
SDG 9 Industry Innovation and Infrastructure	Manufactured Capital Intellectual Capital Natural Capital Social and Relationship Capital	63, 94, 100, 140
SDG 10 Reduced inequality	Human Capital Social and Relationship Capital	80, 84, 137
SDG 11 Sustainable Cities and Communities	Social and Relationship Capital	140, 141
SDG 12 Responsible Consumption and Production	Manufactured Capital Intellectual capital Natural Capital	66, 94, 112
SDG 13 Climate Action	Natural Capital	102
SDG 15 Life on Land	Natural Capital	127
SDG 16 Peace, Justice and Strong Institutions	Social and Relationship Capital	137



# Sustainability Accounting Standards Board (SASB)

Table 1. Sustainability Disclosure Topics & Accounting Metrics

Topic	Accounting Metric	Code	Location	
Greenhouse Gas Emissions	Gross global Scope 1 emissions, percentage covered under emissions-limiting regulations	EM-MM-110a.1	105 (Emission Management)	
	Discussion of long-term and short-term strategy or plan to manage Scope 1 emissions, emissions reduction targets, and an analysis of performance against those targets	EM-MM-110a.2	105 (Emission Management)	
Air Quality	Air emissions of the following pollutants: (1) CO, (2) NOx (excluding N2O), (3) SOx, (4) particulate matter (PM10), (5) mercury (Hg), (6) lead (Pb), and (7) volatile organic compounds (VOCs)	EM-MM-120a.1	106, 107 (Stack Emissions)	
Energy Management	(1) Total energy consumed, (2) percentage grid electricity, (3) percentage renewable	EM-MM-130a.1	103 (Energy Consumption)	
Water Management	(1) Total fresh water withdrawn, (2) total fresh water consumed, percentage of each in regions with High or Extremely High Baseline Water Stress	EM-MM-140a.1	118, 119 (Securing Water)	
	Number of incidents of non-compliance associated with water quality permits, standards, and regulations	EM-MM-140a.2	122 (Effluent Management)	
	Total weight of non-mineral waste generated	EM-MM-150a.4	114 (Non-Hazardous Waste)	
	Total weight of tailings produced	EM-MM-150a.5	116 (Maximising Circularity)	
Waste & Hazardous Materials Management	Total weight of hazardous waste generated	EM-MM-150a.7	115 (Hazardous Waste)	
	Total weight of hazardous waste recycled	EM-MM-150a.8	115 (Hazardous Waste)	
	Number of significant incidents associated with hazardous materials and waste management	EM-MM-150a.9	NIL	
	Description of waste and hazardous materials management policies and procedures for active and inactive operations	EM-MM150a.10	115 (Hazardous Waste)	
	Biodiversity Impacts	Description of environmental management policies and practices for active sites	EM-MM-160a.1	127, 128 (Safeguarding Biodiversity)
		Percentage of (1) proved and (2) probable reserves in or near sites with protected conservation status or endangered species habitat	EM-MM-160a.3	127, 128 (Safeguarding Biodiversity)
Security, Human Rights & Rights of Indigenous Peoples	Percentage of (1) proved and (2) probable reserves in or near areas of conflict	EM-MM-210a.1	85 (Human Rights)	
	Percentage of (1) proved and (2) probable reserves in or near indigenous land	EM-MM-210a.2	85 (Protecting Indigenous Communities)	
	Discussion of engagement processes and due diligence practices with respect to human rights, indigenous rights, and operation in areas of conflict	EM-MM-210a.3	85 (Human Rights)	

## Sustainability Accounting Standards Board (SASB)

Topic	Accounting Metric	Code	Location
Community Relations	Discussion of process to manage risks and opportunities associated with community rights and interests	EM-MM-210b.1	85 (Human Rights)
Labor Relations	Percentage of active workforce covered under collective bargaining agreements, broken down by U.S. and foreign employees	EM-MM-310a.1	83 (Employee Well Being and Human Rights)
Workforce Health & Safety	(1) MSHA all-incidence rate, (2) fatality rate, (3) near miss frequency rate (NMFR) and (4) average hours of health, safety, and emergency response training for (a) full-time employees and (b) contract employees	EM-MM-320a.1	88 (Occupational Health and Safety)
Business Ethics & Transparency	Description of the management system for prevention of corruption and bribery throughout the value chain	EM-MM-510a.1	Corporate Governance Report

**Table 2. Activity Metrics**

Activity Metric	Code	Location
Production of (1) metal ores and (2) finished metal products	EM-MM-000.A	56 (Production Capacity)
Total number of employees, percentage contractors	EM-MM-000.B	72 (Organisation Effectiveness-Employee Strength)

Note: The BRSR content index can be found in the later section of this report.

Middelfart Savings Bank in Denmark built using pre-painted Novelis aluminum ff2® and FALZONAL® for the façade cladding and roofing







# Management Discussion & Analysis

Hindalco Industries Limited, the metals flagship of the Aditya Birla Group, is the world's largest aluminium rolling and recycling company, a major copper player and one of Asia's largest producers of primary aluminium. Hindalco was named the world's Most Sustainable Aluminium Company in the Dow Jones Sustainability Indices (DJSI) in 2020 and 2021.



## FY2021-22: Key Highlights

**Consolidated**  
**₹1,95,059** CR (↑ 48%)  
Revenue

**₹30,056<sup>^</sup>** CR (↑ 59%)  
EBITDA

**₹13,730** CR (↑ 294%)  
PAT

**Novelis**  
**3,858** KT Overall shipments  
**US\$530** BN Record Yearly adjusted EBITDA/ton

**US\$2.045** BN (↑ 19%)  
Record Adjusted EBITDA (excluding metal price lag)

**US\$1,018** BN (↑ 122%)  
Record Net Income from continuing operations

**India Business**  
**1,294** KT Aluminium metal production  
**1,302** KT Aluminium metal sales  
**3,235<sup>\*</sup>** KT Alumina production

**359** KT Copper Cathode production  
**405** KT Copper Metal Sales

**Aluminium value-added products (VAP)**  
**349** KT Production  
**348** KT Sales

**Copper value-added product (Copper Rods)**  
**259** KT Production  
**262** KT Sales

In India, Hindalco's aluminium manufacturing units comprise the full value chain, from bauxite mining, alumina refining, coal mining, captive power generation and aluminium smelting to downstream value addition of Aluminium rolling, extruding and foil making. Hindalco's copper facility in India comprises a world-class custom copper smelter at a single location with downstream facilities, a fertiliser plant and a captive jetty. Hindalco is one of the largest suppliers of Copper to the Indian Railways.

Guided by its purpose of building a greener, stronger, smarter world, Hindalco provides innovative solutions for a sustainable planet. Today, Hindalco's global footprint spans 50 manufacturing units across 10 countries. Its wholly-owned subsidiary Novelis is the world's largest producer of aluminium beverage can stock and the largest recycler of used beverage cans (UBCs). Novelis provides innovative solutions to its customers in the beverage cans, automobile, aerospace and high-end speciality markets such as foil packaging, certain transportation products, architectural, industrial, and consumer durables. Novelis operates an integrated network of technically advanced rolling and recycling facilities across North America, South America, Europe and Asia. Novelis, which has recycling operations in 15 operating facilities across the world, recycles over 82 Billion cans a year, enough to circle the globe more than 160 times.

In FY2021-22, the Company delivered its best financial and operational performance, reporting its highest ever profits. This stellar showing was driven by favourable macros, higher volumes, strategic product mix, lower input costs, stability in operations and improved performance of downstream business in India and overseas. Novelis reported its best-ever adjusted EBITDA, adjusted EBITDA per ton, overall shipments and Net Income in FY2021-22. On a consolidated basis, Hindalco continued to maintain its strong balance sheet in FY2021-22, resulting in a 1.36x Net Debt-to-EBITDA of at the end of the year against 2.59x in the previous year.

**82** BN  
Total cans recycled in FY2021-22

<sup>\*</sup> includes Utkal, the wholly-owned subsidiary;  
<sup>^</sup> Exceptional Income / (Expenses) for the ended 31 March 2022 exclude ₹418 Crore which represents the principal portion of (a) PIS/COFINS related tax credit income in Brazil of ₹358 Crore (net of litigation cost of ₹9 Crore) and (b) tax rebates for sales to Manaus, Brazilian Free Trade Zone and ₹60 Crore, as it is included in the results of Novelis segment (part of EBITDA).



# Management Discussion & Analysis

## Key initiatives during the year

Hindalco India has taken several cost optimisation initiatives across the value chain to improve efficiency and reduce the overall cost of production at all its facilities. The Utkal Expansion providing low-cost alumina, better coal mix and operational efficiencies has helped the Company to reduce its cost of production. As a result, Utkal Alumina continues to remain in the first quartile of the global cost curve in FY 2021-22.

Hindalco sustainable business model and the downstream strategy of product expansion in India will nearly double its existing downstream capacity in the next five to six years. Hindalco has recently completed acquisitions of Hydro's Kuppam Extrusions facility in India and Copper CCR facility of Polycab (Ryker Base) expanding overall capacities in the value-added segment during the year. In FY2021-22, Utkal Alumina refinery successfully completed expansion via debottlenecking of 500 kt taking its total capacity to 2.1 Million MT. Further debottlenecking is planned at Utkal Alumina by 350 kt to take the capacity to around 2.5 Million MT by FY 2023-24.

In line with its growth strategy of organic expansions, Hindalco has recently announced investments in Downstream and Upstream spread over next five years in the businesses of Aluminium, Copper, Specialty Alumina and Resource Securitisation through new commercial coal mines between FY23 and FY27. These investments are expected to be in the range of \$3.0-\$3.3 Billion, though certain projects are under appraisal. These investments are mainly targeted towards downstream capacity expansions in Aluminium, Copper and Specialty Alumina to cater the growing demand in domestic markets. The Company's intent is to build a larger value-added product portfolio over the next few years. This investment indicates confidence in the economic revival, which will raise the demand for downstream value-added products.

Novelis' acquisition of Aleris in 2020 has been highly accretive in terms of market positioning and synergies. Novelis has identified more than \$220 Million in synergies, exceeding its original estimate at time of acquisition of achieving approximately \$150 Million. Through 31<sup>st</sup> March, 2022, Novelis has achieved \$112 Million of run rate cost synergies.

Novelis remains committed to all its organic growth expansion projects. Novelis launched a multi-year strategy to transform and improve the profitability its business through significant investment in new capacity and capabilities. Future investment opportunities in new capacities and facilities, between FY2023 and FY2027, is expected to be more than \$4.5 Billion, funded by stable cash flow generation. These new facilities in US,

China, South Korea, Germany, and Brazil will cater to the entire portfolio of offerings. Of the estimated range of total investments, ~USD 3 Billion is expected to be invested in the US.

Hindalco retained its position as the Aluminium Industry Leader for its sustainability performance in the 2021 edition of the S&P Dow Jones Sustainability Indices (DJSI) Corporate Sustainability Assessment (CSA). Industry Leaders are the top-performing companies in the Index. Hindalco was again featured in the S&P Global Gold Class category as 'Sustainability Leaders of 2022' in the Dow Jones Sustainability Yearbook 2022.

Through LEAD (Leverage, Efficient, Augment and Digital Savvy), Hindalco's digital transformation initiative, we are trying to arm our employees with the analytics and insights to take decisions with speed and confidence. LEAD will help us capture benefits across the entire manufacturing value chain—increasing production capacity, reducing material losses, improving customer service and delivery times and reducing environmental impact. These gains are expected to strengthen Hindalco's competitive position.

## 1. Industry analysis

### 1.1 Aluminium Segment and Industry Review

In CY2021, the global economy witnessed a post pandemic rebound to 6.1%. In CY2021, the Global Production of Aluminium grew 4% yoy to 67.4 Million MT while global consumption rebounded sharply by 10% to ~69 Million MT due to pent up demand. Hence, global markets were in deficit of ~1.6 Million MT in CY2021. On a region-wise split in CY2021, production in China increased by 5% yoy to 38.5 Million MT led by increases in Yunnan, Inner Mongolia, and Henan. Aluminium intake in China was primarily driven by a sharp increase in demand for electric vehicles and solar. The demand Aluminium in China was subdued in the building and construction and auto segments. Hence, overall consumption in China grew by ~6% to ~40 Million MT in CY2021 resulting in a market deficit of ~1.6 Million MT. In the Rest of the World, production grew by 3% yoy to ~29 Million MT led by production increase in Middle East, Central & South America and India. Low base effect and solid demand from packaging segment helped consumption rebound by 14% yoy to 29 Million MT. Hence, the ROW markets were balanced.

As the Global markets remained in deficit, the inventory levels continued to decline from 11 Million MT to 9.4 Million MT. In CY2021, the prices averaged at \$2,480 as against \$ 1,704 in CY2020. In Q1 CY2022, the global aluminium prices continued to grow to \$3,280/ton. The rally in aluminium prices in Q1 CY2022 was driven by Russia-Ukraine geopolitics and depleting global inventories.

Primary Production (in Million MT)

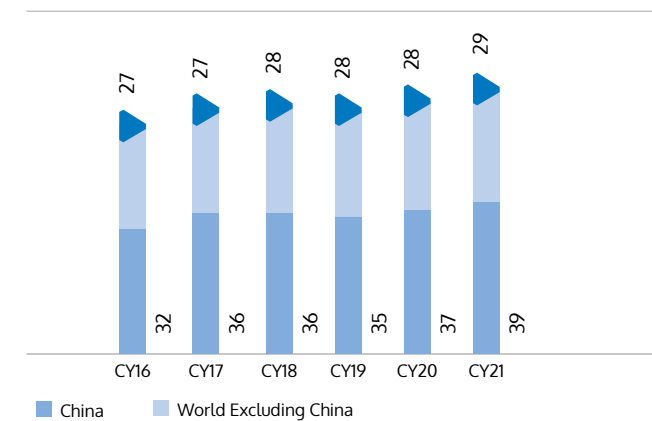

Primary Consumption (in Million MT)

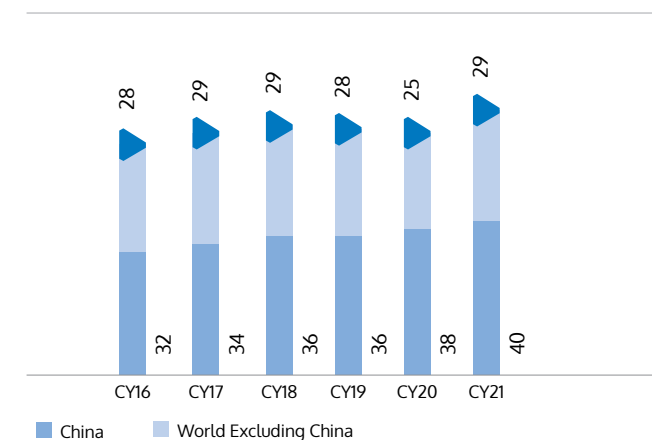

Table 1: Global Production and Consumption (in Million MT)

In Million MT	CY2019	CY2020	CY2021
Production	63.3	64.7	67.4
Consumption	64.6	62.9	69.0
Surplus	-1.4	1.8	-1.6

The average value of premiums was also volatile. By the end of CY 2021, Spot Main Japanese Port (MJP), European Rotterdam Ingot duty and US Midwest premium was \$156/t, \$268/t and \$ 27 cents/lb, respectively versus \$86/t, \$129/t and \$12 Cents/lb, respectively in CY 2020.

As economic activity resumed, domestic consumption saw significant improvement across all sectors over the year. Domestic consumption is likely to grow by 15% yoy in FY 2021-22 and 6% over Pre-COVID levels. Imports continue to be a concern for domestic players. Overall imports, including scrap, touched ~2.3 Mt in FY2021-22 from ~2.1 Mt in FY2020-21.



Global Aluminium Prices (\$/MT)

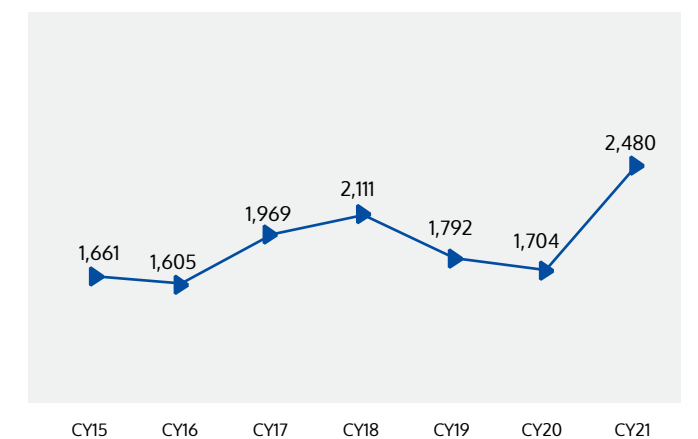

Table 2 : Sector Wise Domestic Consumption for FY2019-20 vs FY2021-22 and FY2020-21 vs FY2021-22

Sector	Growth (%)	
	FY2021-22 vs. FY2020-21	FY2021-22 vs. FY2019-20
Electrical	0 to 10%	-15 to -5%
Building and construction	20 to 30%	-5 to 5%
Auto	20 to 30%	5 to 15%
Industrial and Defence	5 to 15%	20 to 30%
Print	30 to 40%	-20 to -30%
Packaging	10 to 20%	10 to 20%
Consumer Durables	15 to 25%	15 to 25%
Others	0 to 10%	0 to 10%
Overall India Consumption	15%	6%

Source: Company Estimates



# Management Discussion & Analysis

## 1.1.1 Outlook:

Global growth is likely to moderate to 3.6% in CY2022 from 6.1% in CY2021. War-induced commodity price increases and broadening price pressures have led to CY 2022 inflation projections of 5.7% in advanced economies and 8.7% in emerging market and developing economies. Overall, in CY 2022, primary demand is likely to grow by 1% to ~69 Million MT. Production is expected to be around ~70 Million MT. Hence the market is likely to be balanced. Production in the world excluding China is expected to increase by ~1% to ~29 Million MT. Primary aluminium supply in China is likely to grow by 5% to ~40 Million MT. Consequently, the inventories are likely to remain stable at 9.0 Million MT by the end of CY2022.

### Demand Drivers for World Ex China

World Ex China	Demand Drivers
Transport	Government provides purchase incentives to the buyers of electric vehicles
Construction	Stable residential demand in key region and re-opening of economies post COVID-related lockdown.
Packaging	Substitution against PET bottles in Europe and North America. Aluminium Beverage cans replacing PET and glass bottles.
Foil stock	

### China Outlook:

China	Demand Drivers
Transport	Significant aluminium demand over the next 3 years due to rising sales of EVs (auto body sheet, battery foil). Light weighting supported by stringent national emission standards and achieve dual control target.
Construction	Reducing loan prime rate to support demand
Packaging	Stable demand from food and pharmaceutical sectors
Foil Stock	
Electrical	State grid to build "24 AC and 14 DC" Ultra High Voltage projects involving >30,000 km transmission lines
Consumer Durables	Strong domestic and export demand
Machinery & Equipment	Good industrial production and investment growth to support growth

The domestic market is likely to see a broad-base recovery across all sectors. Imports of aluminium products, including

scrap, continue to remain a major concern for domestic aluminium producers. Over the last few years the domestic rolled and foil products industries have been hit by increased dumping of imports, especially from China and FTA countries. Some of this has been countered through 'trade remedial measures' to combat the surge of imports.

## 1.2 Copper - Industry Review & Outlook

In CY2021, on a yearly basis, refined copper consumption globally saw an increase of 6% to 24.4 Million MT against 23.0 Million MT in CY2020. Copper intake in China grew by 5%, whereas in the World Ex China, it increased by 7%.

### Refined Copper Production

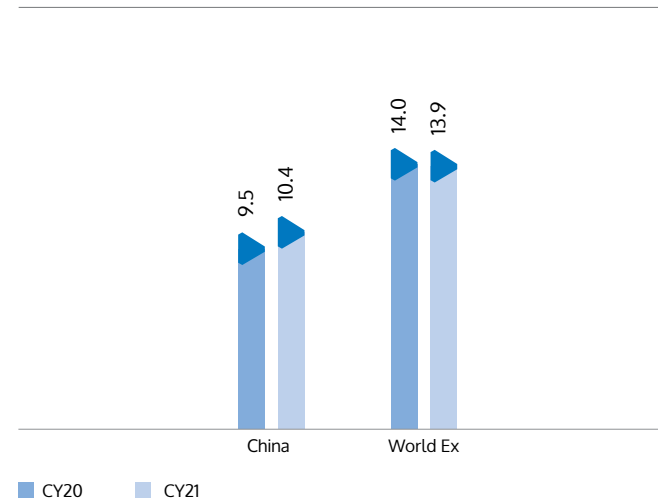

### Refined Copper Consumption

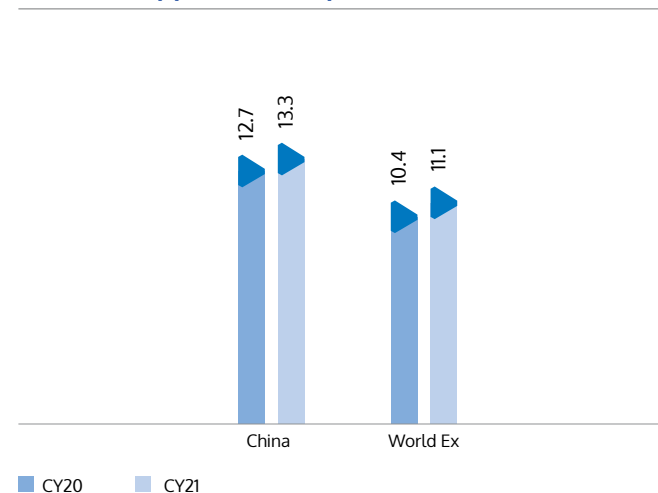

On a yearly basis, domestic market demand increased by 8% to 612 kt in FY2021-22 from 567 kt in FY2020-21. The market share of imports declined 5% to 26% (157 kt) in FY2021-22 from 31% (178 kt) in FY2020-21.

The CY 2022 Annual Tc/Rc benchmark was finalised at 65/6.5 (16.7 c/lb), which is a 9% improvement over the CY 2021 benchmark of 59.5/5.95 (15.26 c/lb). With the ramp-up of key large-scale mining projects and new mines like QB2 & Quellaveco getting operational in CY 2022, the concentrate market is looking at a likely surplus of ~250 kt in CY 2022 against a deficit of ~ 299 kt during CY 2021, which should allow spot Tc/Rc terms to recover. Accordingly, Tc/Rc is expected to improve for the rest of this year as well as next year.

### 1.2.1 Outlook

Global demand for refined copper is expected to increase by ~2.4% in CY 2022. China is expected to grow by ~2.1% and the rest of world is expected to grow by ~2.8%. Demand for Refined Copper in India is likely to improve and recover to pre-COVID levels in FY2022-23 of 750kt.

In the medium-term, the risks to mine supply have increased due to several factors, including western sanctions on Russia which will probably hit the development of mine projects in that country, increased social conflict in Peru and continued regulatory uncertainty in Chile. At the same time, China will continue to invest in new smelter capacity, though at a reduced scale. COVID-19 related lockdowns in China disrupting manufacturing activities will be a passive factor in the supply-demand trend.

## 1.3 Novelis – Global FRP Industry Review and Outlook

The global demand for aluminium and rolled products remains strong, driven by economic growth, material substitution and sustainability considerations including increased environmental awareness around polyethylene terephthalate plastics. Although the early months of FY2021 were negatively impacted by a short-term reduction in demand for aluminium rolled products particularly in the automotive and aerospace markets, pandemic-related demand disruptions have since been in check. However, it is difficult to predict impacts of the ongoing pandemic on future demand. Economic growth, material substitution, and sustainability considerations including increased environmental awareness around polyethylene terephthalate (PET) plastics continue to support long-term increasing global demand for aluminium and rolled products.

Except for China, where can sheet overcapacity and strong competition remains, favourable market conditions and increasing customer preference for sustainable packaging options is driving higher demand for recyclable aluminium beverage cans and bottles.



Demand for aluminium automotive sheet began to be impacted by the semiconductor shortage in the automotive industry at the start of FY2022, and we expect uneven demand to continue in the CY2022. The demand for auto sheets has been primarily driven by the benefits that result from using lightweight aluminium in vehicle structures and components, as automakers respond to stricter government regulations regarding emissions and fuel economy, while maintaining or improving vehicle safety and performance. We are also seeing increased demand for aluminium for electric vehicles as the metal's lighter weight can result in extended battery range.

The long-term demand for building and construction and other specialty products is expected to grow on account of increased customer preference for lightweight, sustainable materials. The requirement for aluminium plates in Asia is set to grow, driven by the development and expansion of industries serving aerospace, rail and other technically demanding applications.

Aerospace demand which was muted in FY2021-22 due to pandemic-induced air travel restrictions, intake is expected to improve to pre-COVID levels by the end of fiscal 2023. In the longer-term, significant aircraft industry order backlogs for key OEMs, including Airbus and Boeing, would translate into growth and our multi-year supply agreements have positioned us to benefit from future demand.

Novelis experienced some inflationary cost pressures in FY2021-22 resulting from global supply chain disruptions impacting the availability and price of materials and services including freight, energy, coatings and alloys. Rising geo-political instability, which had aggravated inflationary cost pressures in the fourth quarter of FY2021-22, are expected to continue in the foreseeable future. Novelis is well positioned to maintain current production levels and service its customers without disruptions in the near term. While Novelis' near-term results are being negatively impacted by higher input costs, it has been able to mitigate some of it through a combination of hedging, cost passthrough to customers, favourable pricing environments and increased recycling benefits.

For a region-wise detailed business overview, please refer to the 10K filed by Novelis Inc. dated May 11<sup>th</sup>, 2022 for the year ended March 31, 2022.

# Management Discussion & Analysis

## 2. Business Segment Review

### 2.1 Hindalco – SWOT Analysis

India Aluminium			
<b>Strengths</b> <ul style="list-style-type: none"> <li>Fully Integrated business model</li> <li>Dominant player in India across upstream and downstream</li> <li>Utkal - among the world's most economical and efficient Alumina producers; with capacity expansion of 500 kt Utkal capacity reached 2.1 Mt in FY2021-22</li> <li>Increased focused on Value Added Products (VAP) will lead the company to be delinked from LME</li> <li>Market leadership in Flat Rolled Products</li> </ul>	<b>Weakness</b> <ul style="list-style-type: none"> <li>Commodity product (upstream)</li> <li>Smaller market share in Extrusions and Foils</li> <li>Upstream business linked to LME volatility</li> </ul>	<b>Opportunities</b> <ul style="list-style-type: none"> <li>Immense headroom for a growing market in India; Per Capita Aluminium consumption in India at 1/4<sup>th</sup> of global average</li> <li>Rising Aluminium Consumption in the end use segments like Building &amp; Construction, Automotive, Packaging, and Consumer Durables</li> <li>Substitution opportunity versus steel, uPVC, wood, among others.</li> <li>Light-weighting initiatives in commercial vehicles, personal mobility, etc. leading to a higher Aluminium adoption in the country.</li> <li>PLI scheme for White Goods and proactive trade measures by the Government to help in import substitution.</li> </ul>	<b>Threats</b> <ul style="list-style-type: none"> <li>LME, Forex and raw material price volatility</li> <li>Competition from China in the downstream</li> <li>Rising imports of scrap</li> <li>Increasing imports of VAP from the Free Trade Agreement (FTA) countries.</li> <li>Domestic availability/ shortage of resources (mainly coal)</li> </ul>

Novelis			
<b>Strengths</b> <ul style="list-style-type: none"> <li>Diverse, high-value product portfolio with unmatched global presence and scale</li> <li>Very stable customer base locked in long-term contracts</li> <li>Ability to grow pricing in capacity constrained and high growth end markets</li> <li>Market leader in a more recession resistant beverage packaging end-market</li> <li>Leading recycling capabilities with ~60% recycled content and growing hence driving sustainability and providing cost competitiveness</li> </ul>	<b>Weakness</b> <ul style="list-style-type: none"> <li>Capacity constrained next 2-3 years until capacity expansion projects underway are complete</li> <li>Long-term contracts while providing volume stability but create time lag between inflation and ability to pass on higher costs to customers</li> </ul>	<b>Opportunities</b> <ul style="list-style-type: none"> <li>Key end markets - Can and Auto - growing faster than GDP growth due to strong recycling and sustainability value proposition offered by Aluminum</li> <li>Build on existing sustainability leadership by expanding recycling capabilities</li> <li>Digitalising the value chain, including implementing a 'Plant of the Future' operating model to drive efficiency gains and overall operational excellence</li> </ul>	<b>Threats</b> <ul style="list-style-type: none"> <li>Supply chain disruption and high cost inflation</li> <li>Geo-political instability, increasing tariffs, protectionist measures and cybersecurity risks</li> <li>Increasing competition for scrap input materials</li> </ul>

Copper			
<b>Strengths</b> <ul style="list-style-type: none"> <li>A balanced portfolio of revenue streams to tide through volatile market</li> <li>Secured concentrate supply via long-term contracts with miners</li> <li>Focus on VAP like Copper Rods and Inner Grooved Tubes (IGT)</li> </ul>	<b>Weakness</b> <ul style="list-style-type: none"> <li>Dependence on imported Copper concentrate</li> </ul>	<b>Opportunities</b> <ul style="list-style-type: none"> <li>Immense headroom for growth due to lower consumption vs global average</li> <li>Strong Demand of Copper particularly in the EV segments</li> </ul>	<b>Threats</b> <ul style="list-style-type: none"> <li>Mine Disruptions</li> <li>Duties &amp; Free Trade Agreement and trade politics</li> </ul>

### 2.2 Operational Performance and Financial Review

Financial Table: Standalone & Consolidated

(₹ Crore)

Description	HIL Standalone		Consolidated	
	FY2021-22	FY2020-21	FY2021-22	FY2020-21
<b>Revenue from Operations</b>	<b>67,653</b>	<b>42,701</b>	<b>1,95,059</b>	<b>1,32,008</b>
<b>Earning Before Interest, Tax and Depreciation (EBITDA)</b>				
Novelis*			15,229	12,727
Aluminium (Including Utkal)			13,025	5,441
Copper (Including DHIL)			1,390	869
Other Segments			26	26
Unallocable Income/(Expense) - (Net) & GAAP Adjustments			386	(167)
<b>Total EBITDA</b>	<b>11,828</b>	<b>4,884</b>	<b>30,056</b>	<b>18,896</b>
Depreciation & Amortisation (including impairment)	1,847	1,848	6,884	6,766
Finance Cost	1,417	1,469	3,768	3,738
<b>Earning before Exceptional Items, Tax &amp; Share in Profit/(Loss) in Equity accounted Investments</b>	<b>8,564</b>	<b>1,567</b>	<b>19,404</b>	<b>8,392</b>
Share in Profit/(Loss) in Equity Accounted Investments (Net of Tax)	-	-	6	5
<b>Earning before Exceptional Items and Tax</b>	<b>8,564</b>	<b>1,567</b>	<b>19,410</b>	<b>8,397</b>
Exceptional Income/(Expenses) (Net)#	(107)	7	164	(492)
<b>Profit Before Tax (After Exceptional Items)</b>	<b>8,457</b>	<b>1,574</b>	<b>19,574</b>	<b>7,905</b>
Tax Expense	2,950	581	5,373	2,723
<b>Profit/(Loss) from Continuing Operations</b>	<b>5,507</b>	<b>993</b>	<b>14,201</b>	<b>5,182</b>
Profit/(Loss) from Discontinued Operations	-	-	(471)	(1,699)
<b>Profit/(Loss) After Tax</b>	<b>5,507</b>	<b>993</b>	<b>13,730</b>	<b>3,483</b>

\* As per US GAAP

# Pertains to the Consolidated Exceptional Income / (Expenses) for the year ended March 31, 2022, ₹418 Crore, which represents the principal portion of (a) PIS/COFINS related tax credit income in Brazil of ₹358 Crore (net of litigation cost of ₹9 Crore) for FY22 and (b) tax rebates for sales to Manaus, Brazilian Free Trade Zone ₹60 Crore for FY22, as it is included in the results of Novelis segment.



# Management Discussion & Analysis

## Hindalco Aluminium Business Review

### 2.2.1 Operational Overview – Aluminium

The Company delivered a strong financial and operational performance in its aluminium business in FY2021-22 primarily due to favourable macros, higher volumes, better operational efficiencies and improved performance of downstream business despite headwinds from higher input costs. The production of aluminium stood at 1.294 Million MT in FY 2021-22 versus 1.229 Million MT in the corresponding year. The overall alumina production stood at 3.235 Million MT versus 2.699 Million MT in FY2020-21. This includes the additional volumes from 500 kt brownfield Utkal Expansion, commissioned during the second half of FY2021-22. Utkal Alumina recorded production of 2.048 Million MT in FY2021-22 and continues to be the most economical and efficient alumina producer globally, running at maximum capacity to produce 2.1 Million MT of world-class alumina and providing strong support to most of Hindalco’s India smelting facilities, leading to better cost optimisation and quality input (alumina).

The overall metal sales in all forms were at 1.302 Million MT in FY2021-22 against 1.250 Million MT in FY2020-21, up by 4% yoy on account of market recovery and higher value-added sales in FY2021-22. Production of VAP was higher by 30% yoy, at 349 kt in FY2021-22 vs 269 kt in FY2021-22.

### 2.2.2 Financial Overview

#### Aluminium

Revenue for Hindalco’s aluminium segment was up 57%, rising to ₹32,169\* Crore in FY2021-22 from ₹20,518\* Crore in FY2020-21 on account of higher global aluminium prices. EBITDA was up 139% at an all-time high of ₹13,025 Crore versus ₹5,441 Crore a year earlier on account of favourable macros, higher volumes, better operational efficiencies and improved performance of downstream business offset by higher input costs. The EBITDA margins were at 40.5% in FY2021-22, one of the best in the industry.

\*The above numbers are without elimination of Inter-segment revenue.

Description	FY2021-22	FY2020-21	% Change
Revenue	32,169	20,518	57%
EBITDA	13,025	5,441	139%

Note: In the consolidated financial statements, within the aluminium segment, the significant entities are Hindalco and Utkal Alumina International Ltd. Utkal Alumina is a wholly-owned subsidiary of Hindalco and supplies a substantial quantity of its production to Hindalco hence we have analyzed the combined performance of Hindalco’s aluminium business along with Utkal Alumina.

The graphs show the trend of total alumina production and aluminium production and sales in last five years:

**Alumina Production** (in Million MT)

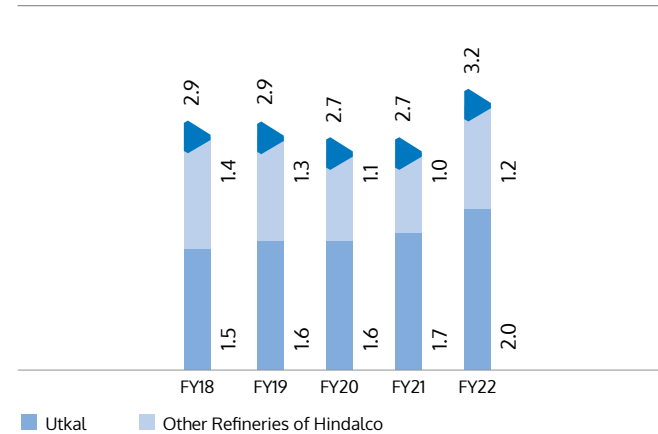

**Metal Production** (in Million MT)

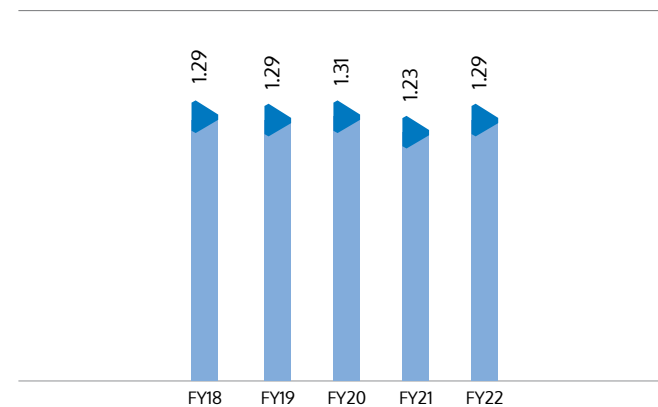

**Metal Sales in All Forms** (in Million MT)

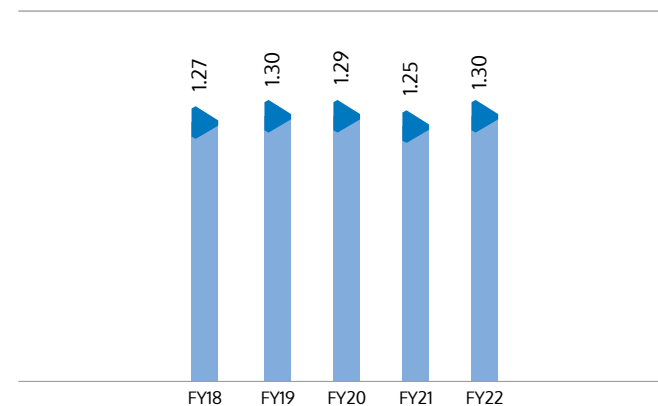

## 2.3 Copper Business Review

### 2.3.1 Operational Overview

Copper smelters ran optimally during FY2021-22 and delivered consistent production. The copper cathode production was 359 kt in FY2021-22, up 37% against the previous year. Copper rod production was at 259 kt in FY2021-22 versus 235 kt in FY2020-21.

Total copper metal sales were at 405 kt in FY2021-22 up by 29% compared to 313 kt in the previous year in line with better production and market demand. The sales of Copper VAP (Copper Rods) were up by 13% at 262 kt in FY2021-22 versus 233 kt in the previous year. The share of VAP (CC Rods) to total metal sales was 64% in FY2021-22, from 74% in the previous year.

On 3<sup>rd</sup> November, 2021 Hindalco acquired Ryker Base Pvt Ltd (Ryker), a 225 kt copper rod manufacturing facility of Polycab Ltd., taking the total capacity of CCR to around 540 kt currently.

The graphs show the trend of total cathode production and Copper Metal and Value Added (CC Rods) sales volume in the last five years:

**Cathode Production** (kt)

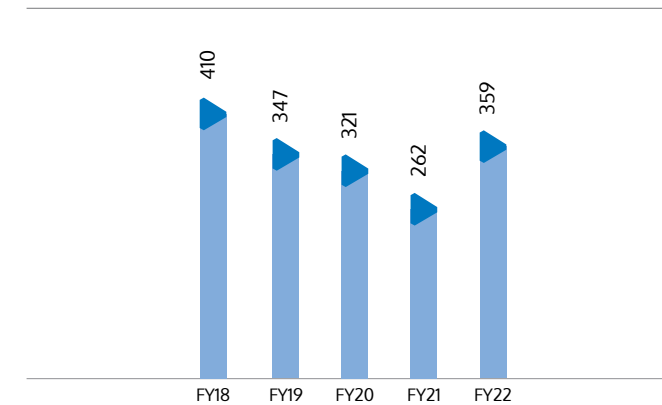

**Copper VAP - CC Rod Sales** (kt)

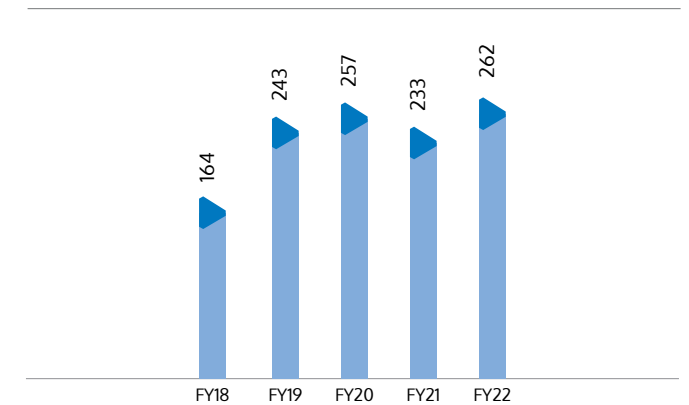

**Copper Metal Sales in all forms** (kt)

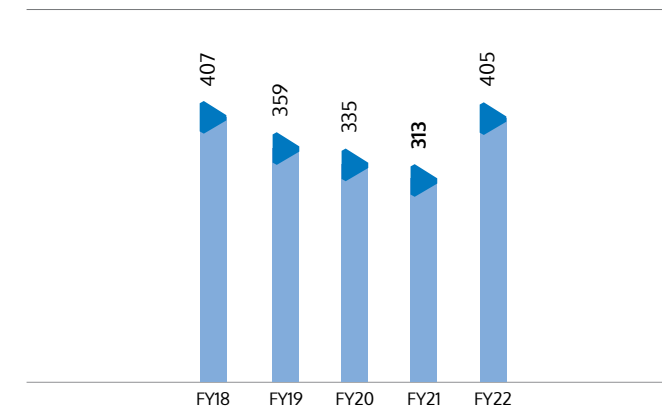

### 2.3.2 Financial Overview

Copper segment revenue for FY2021-22 was at ₹36,723\* Crore (vs. ₹22,446\* Crore in FY2020-21), up 64% on account of higher global prices of copper and higher volumes in this financial year. EBITDA was at ₹1,390 Crore (vs. ₹869 Crore in FY2020-21) up 60% yoy, on account of higher volumes, better operational efficiency and improved by-product realisations in FY2021-22.

\*The above numbers are without elimination of Inter-segment revenue

Description	FY2021-22	FY2020-21	% Change
Revenue	36,723	22,446	64%
EBITDA	1,390	869	60%

# Management Discussion & Analysis

## 2.4 Novelis Business Review

### 2.4.1 Operational Overview

Novelis Inc., is the global leader in flat-rolled aluminium products and the world's largest recycler of aluminium. Driven by its purpose of shaping a sustainable world, Novelis works alongside its customers to provide innovative solutions to the beverage can, automotive, aerospace and speciality markets (which include foil packaging, certain transportation products, architectural, industrial, and consumer durables). Novelis operates an integrated network of technically advanced rolling and recycling facilities across North America, South America, Europe, and Asia, and leverages its global manufacturing and recycling footprint to consistently deliver high-quality products around the world.

Novelis reported its best-ever financial performance in FY2021-22, despite semiconductor chip shortage in automotive, slowly reviving aerospace segment and some short-term operational challenges in quarter four of FY2021-22. In FY2021-22, Novelis recorded its best-ever adjusted EBITDA and EBITDA per ton mainly driven by its portfolio optimisation, better cost efficiency, favourable product mix, innovations, customer centricity and favourable demand for lightweight, sustainable aluminium solutions across end markets. Novelis leveraged its extensive recycling footprint and favourable market conditions to utilise high levels of recycled content in its shipments in FY 2021-22.

In FY2021-22, total shipments were up by 7% over the last year to 3.858 Million MT, driven by strong demand for sustainable, flat rolled aluminium sheet and recovery from COVID-related production shutdowns early in the previous financial year.

Share of beverage can sheet shipments were 58% in FY 2021-22, automotive body sheet shipments were at 17% in FY2021-22, despite challenges on account of global semi-conductor chip shortages. The specialities and aerospace shipments were 23% and 2% respectively in FY2021-22.

Novelis operates in four key geographies: North America, Europe, Asia and South America. In North America, in FY-2021-22, total shipments were at 1,466 kt. In Europe, the Company shipped 1,048 kt across product categories in FY 2021-22. In Asia, Novelis shipped 737 kt of rolled products in FY2021-22 versus 740 kt in FY2020-21. In South America, Novelis shipped 617 kt in FY2021-22, up from 577 kt in the previous year.

In FY2021-22, Novelis reported a record overall adjusted EBITDA/MT of \$530, up from \$474/MT in the last year, reflecting strong and consistent performances year after year.

FRP Shipments (kt) and Adjusted EBITDA per ton (\$/t)

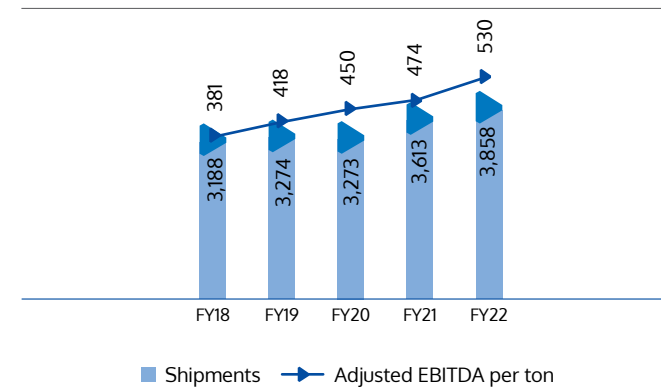

With Novelis' thrust on sustainability and recycled aluminium, the share of recycled inputs was at 57% in FY2021-22. The Company has invested significantly in recycling initiatives and developed high-tech recycling capabilities over the years. Its new 100 kt rolling, casting, and recycling expansion projects in Pinda, Brazil commissioned during FY2021-22, added to Novelis' overall rolling capacity which reached 4.0 Million MT at the end of FY2021-22.

### 2.4.2 Financial Overview

Novelis' total revenue in FY2021-22 were at \$17.1 Billion, up 40%, mainly driven by higher average global aluminium prices, local market premiums and record shipments in every product end market. Adjusted EBITDA stood at a record high of US\$ 2.045 Billion, up 19%, on the back of higher volume, favourable product mix and strong environment benefiting pricing, partially offset by high inflation and operational disruptions.

Novelis reported adjusted free cash flow from continuing operations of \$649 Million, after absorbing more than \$ 400 Million of increased working capital pressure from rising aluminium prices, net of metal price lag compared with \$ 740 Million as the end of previous financial year.

Driven mainly by higher adjusted EBITDA, Net Income (without special items) from continuing operations is up 66% yoy at \$ 934 Million in FY2021-22 against \$561 Million in FY2020-21.

	(\$ Million)		
Description	FY2021-22	FY2020-21	% Change
Revenue	17,149	12,276	40%
Adjusted EBITDA	2,045	1,714	19%
Net Income/ (loss) w/o Exceptional Item*	934	561	66%

\*Tax-effected special items may include restructuring & impairment, metal price lag, gain/loss on assets held for sale, loss on extinguishment of debt, loss/gain on sale of business



The newest NFL super stadium, SoFi Stadium, in Inglewood, California, uses Novelis aluminium in critical structures

## 3. Consolidated Financial Statements

### 3.1 Revenue

Hindalco's consolidated revenue was up 48% at ₹1,95,059 Crore in FY2021-22 compared to ₹1,32,008 Crore in FY2020-21, primarily driven by higher global aluminium prices and local market premiums. The graphs below show the split of Consolidated Revenues by businesses in FY2021-22 and the trend of revenues over the past five years.

Consolidated Revenue split by Business for FY2021-22: (%)

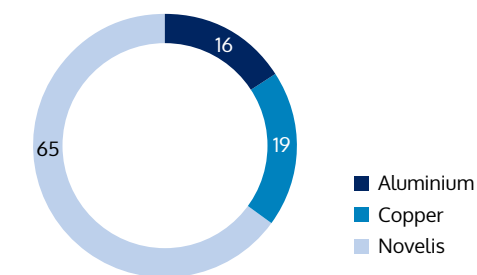

Consolidated Revenue (₹ Crore)

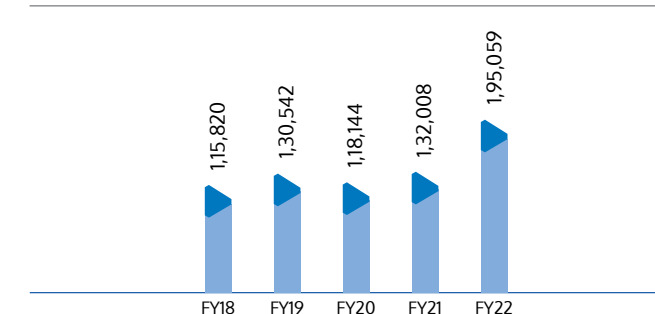

### 3.2 EBITDA

Consolidated EBITDA for FY2021-22 was higher by 59% to ₹30,056 Crore from ₹18,896 Crore in the previous year. This was due to higher EBITDA in the aluminium business in India and best-ever performance by Novelis in FY2021-22. The EBITDA margin in FY2021-22 was at 15.4% compared to 14.3% in FY 2020-21. The graphs below show the consolidated EBITDA split by businesses in FY2021-22 and trends over the past five years.

Consolidated EBITDA split by Business: FY2021-22 (%)

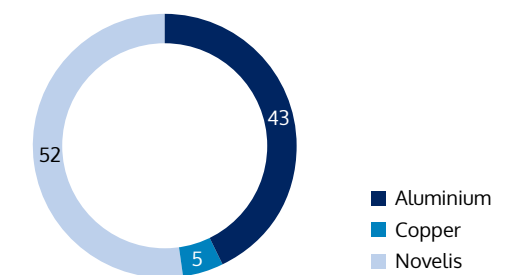

Consolidated EBITDA (₹ Crore)

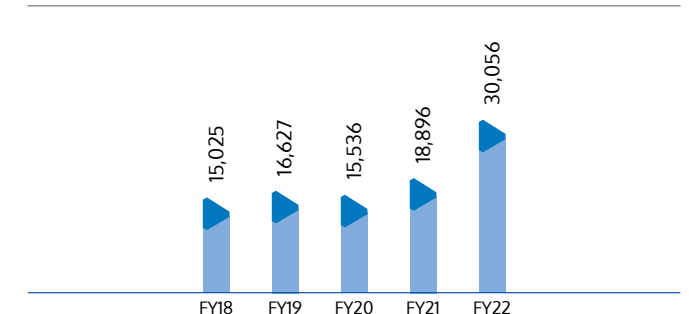



# Management Discussion & Analysis

Novelis' aluminium facades help create striking and sustainable structures that last for decades



### 3.3 Finance Cost

Finance Cost decreased 1% and was at ₹3,768 Crore in FY2021-22 from ₹3,738 Crore in FY2020-21 due to lower interest cost of long-term loans in India and refinancing of term loans by Novelis. Novelis refinanced 5.875%, \$1.5 Billion Senior Notes due in September 2026 via 3.250%, \$750 Million senior notes due in November 2026 and a 3.875%, \$750 Million senior notes due in August 2031. The 2017 term loan of \$1.8 Billion was fully repaid by Novelis before maturity in FY2021-22.

### 3.4 Depreciation and Amortisation (Including net impairment loss/(reversal) of non-current assets)

Depreciation and amortisation (including net impairment loss/(reversal) of non-current assets) increased to ₹6,884 Crore in FY2021-22 from ₹6,766 Crore in FY2020-21 mainly on account of capitalisation and certain reclassifications as per the accounting standards and exchange impact.

### 3.5 Exceptional Income/(Expense)

In FY2021-22, total exceptional income stands at ₹164 Crore excluding ₹418 Crore of principal portion of PIS/COFINS related tax credit income in Novelis Brazil (₹358 Crore and net of litigation cost of ₹9 Crore) and tax rebates for sales to Manaus, Brazilian Free Trade Zone of ₹60 Crore included in the results of Novelis segment.

### 3.6 Taxes

Provision for the tax was at ₹5,373 Crore in FY2021-22 against ₹2,723 Crore in FY2020-21. This increase in taxes was due to higher taxes in Novelis and higher profitability of the Company in FY2021-22.

### 3.7 Profit/(Loss) After Tax

Profit After Tax (PAT) in FY2021-22 was at an all-time high of ₹13,730 Crore compared to ₹3,483 Crore a year ago, up 294% yoy. The net profit margin in FY2021-22 stood at 7.04% versus 2.64% in FY2020-21. The PAT for Continuing operations for FY2021-22 was up 174% yoy at ₹14,201 Crore versus ₹5,182 in FY2020-21.

Metal Sales in all forms (in Million MT)

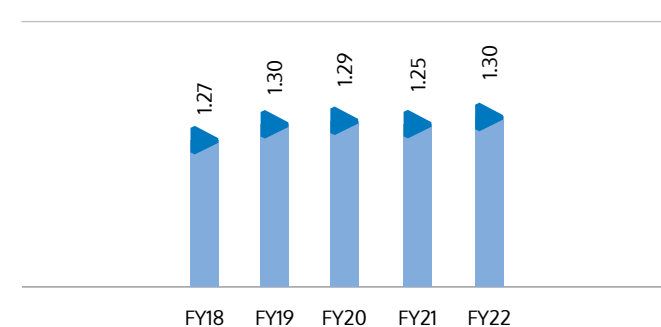

### 3.8 Consolidated Net Debt to EBITDA

The consolidated balance sheet continued to remain strong with the Net Debt to EBITDA at 1.36 times at the end of March 2022 versus 2.59 times at the end of March 2021. (Net Debt to EBITDA = Consolidated Business EBITDA/Consolidated Net Debt)

### 3.9 Key Financial Ratios (Consolidated)

#### (i) Debtors Turnover (Days)

The Consolidated Debtors Turnover Days on 31<sup>st</sup> March, 2022 was 32 days compared to 31 days at the end of 31<sup>st</sup> March, 2021. This shows consistency in managing its credit with customers and this also reflects the Company's strong financial position with respect to most of its customers. The Debtor Turnover (days) is calculated as Average Debtors/Total Consolidated Sales multiplied by 365 days.

#### (ii) Inventory Turnover (Days)

The Consolidated Inventory Turnover Days on 31<sup>st</sup> March, 2022 was at 79 days versus 80 days at the end of 31<sup>st</sup> March, 2021. This shows how the Company managed its inventory levels during the year. The Inventory (days) is calculated as Average Inventory /Cost of Goods Sold (Cost of Sales + Depreciation) multiplied by 365 days.

#### (iii) Interest Coverage Ratio:

The Consolidated Net Interest Coverage Ratio on 31<sup>st</sup> March, 2022 stands at 7.87 times versus 5.06 times at the end of 31<sup>st</sup> March, 2021. This is higher over the previous year because of higher earnings (EBIT) and refinancing of long-term loans in Novelis. This ratio reflects the Company's ability and strength to meet its interest obligations.

#### (iv) Current Ratio

The Consolidated Current/Liquidity Ratio as on 31<sup>st</sup> March, 2022 stands at 1.28x versus 1.39x at the end of 31<sup>st</sup> March, 2021 reflecting the Company's strengthening of liquidity or solvency position compared to the last year.

#### (v) Debt to Equity Ratio

The Consolidated Debt to Equity Ratio as on 31<sup>st</sup> March, 2022 stands well below 1.0x at 0.81x versus 0.99x as on 31<sup>st</sup> March, 2021. This reflects the Company's strong balance sheet and ability to meet its current short-term obligations.

#### (vi) Return in Net Worth (RONW)

The Consolidated Return on Net Worth as on 31<sup>st</sup> March, 2022 stands at 18.97% compared to 5.58% on 31<sup>st</sup> March, 2021. This was higher compared to the previous year due to the higher profits in FY2021-22. This is Calculated based on PAT/Average Net Worth.

#### (vii) Operating Margins

The Consolidated Operating margins in FY2021-22 stands at 14.61% versus 13.41% in FY2020-21 reflecting higher operating profit in FY2021-22 compared to the previous year. (Operating Margin = Operating Profit/Net Sales).

#### (viii) Net Profit Margins

The Consolidated Net profit margins in FY2021-22 stands at 7.04% versus 2.64% in FY2020-21. This was higher on account of higher consolidated profits recorded in FY2021-22. (Net Profit Margin = Net Profit/Net Sales).



Novelis is the world's largest aluminium recycler

# Management Discussion & Analysis

## 3.10 Consolidated Cashflow:

Cash generated from operations for Hindalco Consolidated stands at ₹16,838 Crore in FY2021-22 versus ₹17,232 Crore in FY2020-21.

The table below shows the comparative movement of Cash flows:

Particulars	Consolidated	
	Year ended	
	31-03-2022	31-03-2021
(₹ Crore)		
<b>A. CASH FLOW FROM OPERATING ACTIVITIES</b>		
Operating Cashflow before working capital changes	29,726	17,648
Changes in working capital	(9,132)	1,520
<b>Cash generated from operations before Tax</b>	<b>20,594</b>	<b>19,168</b>
(Payment)/Refund of Direct Taxes	(3,773)	(1,256)
<b>Net Cash generated/(used) - Operating Activities - Continuing Operations</b>	<b>16,821</b>	<b>17,912</b>
<b>Net Cash Generated/(Used) - Operating Activities - Discontinued Operations</b>	<b>17</b>	<b>(680)</b>
<b>Net Cash Generated/(Used) - Operating Activities (a)</b>	<b>16,838</b>	<b>17,232</b>
<b>B. CASH FLOW FROM INVESTMENT ACTIVITIES</b>		
Net Capital Expenditure	(5,355)	(5,517)
Disposal of Investments in Subsidiaries (Net)	66	-
(Purchase)/Sale of Other instruments (Net)	4,226	(2,775)
Acquisition of business, net of cash acquired	(412)	(19,524)
Investment in equity accounted investees	(1)	-
Loans & Deposits (given)/received back (Net)	(6,209)	(261)
Interest and dividends received	239	228
Purchase/Sale of Investment in Equity Shares at FVTOCI (Net)	363	(43)
Lease payments received from finance lease	9	10
<b>Net Cash Generated/(Used) - Investing Activities - Continuing Operations</b>	<b>(7,074)</b>	<b>(27,882)</b>
<b>Net Cash Generated/(Used) - Investing Activities - Discontinued Operations</b>	<b>-</b>	<b>2,245</b>
<b>Net Cash Generated/(Used) - Investing Activities (b)</b>	<b>(7,074)</b>	<b>(25,637)</b>
<b>C. CASH FLOW FROM FINANCING ACTIVITIES</b>		
Equity Raised/Debentures Redeemed	3	-
Treasury shares acquired & Proceeds from Shares Issued by ESOP Trust	(79)	2
Net Debt inflows/Outflows	(2,772)	(968)
Interest & Finance Charges paid	(3,250)	(3,678)
Dividend Paid (including Dividend Distribution Tax)	(667)	(222)
<b>Net Cash generated/(Used) - Financing Activities - Continuing Operations</b>	<b>(6,765)</b>	<b>(4,866)</b>
<b>Net Cash Generated/(Used) - Financing Activities - Discontinued Operations</b>	<b>-</b>	<b>(16)</b>
<b>Net Cash Generated/(Used) - Financing Activities (c)</b>	<b>(6,765)</b>	<b>(4,882)</b>
<b>Net Increase/(decrease) in Cash and Cash Equivalents (a)+(b)+(c)</b>	<b>2,999</b>	<b>(13,287)</b>

## 4. Business Outlook

Hindalco's relentless focus is on product innovation, better efficiencies, complete digitalisation and organic expansions with a diversified product mix and cost competitiveness. Timely completion of 500 kt expansion project at Utkal Alumina refinery is helping the company to reduce the overall integrated cost of production. The Company continues to focus on cash conservation while maintaining adequate liquidity and deliver sustained performance while catching up with the market recovery. The Company's long-term strategic investments in Novelis and the India downstream expansion projects will enhance its capabilities across the FRP and the Extrusion segments in India. In addition, the acquisition of Hydro's Kuppam Extrusions facility and Polycab's Ryker CCR facility in FY2021-22 is aimed at expanding its presence in the upper-end of the value-added market and further strengthen the Company's long-term sustainable business model.

Domestic copper demand is driven largely by rods which is the downstream product for the copper business. Hindalco's strategy of enhancement of Copper VAP capacity through Copper Rods and Copper Inner grooved tubes will help the Company drive a larger market share and meet the growing demand for copper in the domestic market.

Global demand for lightweight, highly recyclable aluminium beverage packaging which is the largest share of Novelis' shipment product portfolio, remains strong in all the regions. Demand for aluminium sheet across specialties markets, including electronics, electric vehicle battery enclosures, painted products, container foil and building and construction markets, also remains strong. While long-term demand trends are intact, the current global semiconductor shortage impacting the automotive industry has resulted in temporary automotive customer shutdowns and has reduced near-term demand for automotive aluminium sheet. In aerospace, some improvement is seen in order bookings because of a slow and uneven recovery in demand for aerospace sheet for through FY2022-23.

Hindalco's strategic priorities and its capital allocation framework which is targeted towards value enhancing organic growth and ESG commitments will bolster the Company's position as the Sustainability Leader in the Industry.

## 5. Price Risk Management

Hindalco's financial performance was significantly impacted by fluctuations in aluminium prices as well as exchange rates and interest rates. The Company takes a structured approach to identify, quantify and hedge such risks by using derivatives in commodity and currency, which are driven by the Company's comprehensive risk management policy.

Our initiatives and performance are detailed in the 'Our Capitals' section of this report.

## 6. Sustainability

At Hindalco sustainability is our core priority, enabling us to create value out of revenue streams that are planet and people positive. Our strong commitment to ESG is proven by our stellar showing in the DJSI CSA assessments which recognised us as the Most Sustainable Aluminium Company in the World. We believe in the power of collaboration and we actively engage with stakeholders across the value chain to address critical sustainability issues and try to resolve them seamlessly. This helps us gain the trust of stakeholders and allows us to grow in synergy with them.

Sustainability at Hindalco is driven at the top level by the Apex Sustainability Committee, chaired by the Managing Director ensuring implementation and monitoring of sustainability initiatives across the organisation. We have task forces and ESG SPOCs from all functions working together to bring about positive change in the organisation. The task forces are made for ensuring ground level implementation of environment initiatives. There are Risk Champions to assess potential risks including those related to ESG. The ESG SPOCs in corporate functions take up projects to further the cause of ESG implementation in the organisation.

We have developed a roadmap to attain net carbon neutrality by 2050. We have already put up 100 MW of renewable energy capacity and we plan to scale it up to 300 MW by 2025. These efforts are being reinforced by various energy efficiency projects and pilot demonstrations of technologies in the pipeline. We are boosting freshwater conservation by augmenting the use of water from other sources like treated water and rainwater. We are aiming for overall water positivity by 2050, with a sub-target of making our downstream and mining operations water positive by 2025. Our efforts on circularity include extracting value out of waste generated and increasing material recycling.

We aim to be zero waste to landfill by 2030, ensuring that waste is being put to good instead of ending up in the landfill. Our work in protecting biodiversity, which was initiated alongside IUCN, has led to the development of BMPs for critical sites. These are now under implementation and will help us attain our target of no net loss by 2050. Our Sustainable Mining Charter and KPIs for implementing the charter under seven thematic areas is another key step to make our mining vertical more sustainable. Our subsidiary Novelis is the largest aluminium recycler in the world.



# Management Discussion & Analysis



On the people front, we are deeply committed to build safer workplaces and a high performance work culture to keep our employees motivated. Over the years we have taken various initiatives in the area of organisation effectiveness to increase productivity of our workforce. Mental and physical health programmes have also helped our people to navigate through these challenging times. We actively engage with local communities to ensure that they prosper alongside us. We implement programmes to cater to the needs of our communities in the areas of Education, Healthcare, Livelihood, Infrastructure, and Social Reforms. We believe in inclusive growth and deploy our resources to bring about a positive impact on the areas we operate in and on society at large.

Details of our initiatives and performance are provided in the 'Our Capitals' section of this report.

## 7. Safety

As a responsible corporate citizen, Hindalco is fully dedicated to human health and safety. Our plants and mines follow occupational health and safety management standards that integrate occupational health, hygiene and safety responsibilities into everyday business. A strong safety culture is required to prevent fatalities and achieve good safety performance. With focused efforts to further strengthen our safety culture, our safety performance this year has been the best ever. There was a 29% drop in loss time injuries, a 18% fall in recordable injuries and a 53% reduction in first aid injuries. Because of this, there is a 29% reduction in Loss Time Injuries Frequency Rate (LTIFR) and Recordable Injuries Frequency Rate. There is a 38% drop on a yoy basis in Loss Time Injuries Severity Rate (LTIFR) in FY2021-22.

While there were no fatalities among Company employees, we lost two contract workmen to work-related injuries. We regret the loss of these valuable lives and shall continue to strengthen our safety culture to make Hindalco a "Zero Harm" organisation.

During the year, we introduced a uniform Contractors' Safety Management procedure across Hindalco. The Serious Injuries and Fatality (SIF) prevention programme, which was introduced last year, has started showing some early promise. With these programmes/standards, we have now nine technical safety standards, nine administrative safety standards and 4 occupational health standards. Our standards and procedures provide a consistent approach to managing major hazards across our operations. To meaningfully implement the standards, we developed 82 new subject matter experts (SME). This is addition to 1,166 SMEs developed over last few years.

We audit our entire operations every year against our standards and require our businesses to meet their health and safety performance requirements and targets. In FY 2021-22, all 15 manufacturing sites of Hindalco were audited virtually using "Real-Ware" due to COVID. In FY2023, we carried out physical audits.

Despite limitations on classroom safety training due to COVID in the early part of the year, we were able to invest more than three manhours of classroom safety training per person (including direct employees and contract workmen) this year also. The focus was more on-the-job training wherever possible, as a result we invested 37% more man-hours on training than the previous year.

A good safety culture depends heavily on the participation of line function employees. Which is why we have devised safety taskforces and six safety sub-committees at each unit for employees to participate in safety programmes. Each member of each task force and sub-committee is deemed a safety officer and contributes to the safety of the units and mines at every level.

In 2020, we completed Qualitative Exposure Assessment (QIEA) and Quantitative Exposure Assessment (QnEA) studies of all our manufacturing facilities and mining operations. By the end of FY2021-22, we were able to implement more than 80% of recommendations and we are making good progress in implementing the remaining recommendations that came out of these studies.

In FY2021-22, the Company continued to offer psychological safety training sessions to employees. Each unit also ran a comprehensive wellness programme recognising the value of good physical and mental health of employees, their families, and the community.

Hindalco has an active Crisis Management Plan using which the Company ensures an appropriate response to all crisis, natural disasters or other emergencies, including COVID-19 corporate level at all units and mines.

## 8. Human Capital

Our 40,000 employees across the globe are our biggest asset in the journey towards building a Greener, Stronger and Smarter future. In recognition of our efforts towards building a High-Trust, High-Performance culture, Hindalco was certified as a 'Great Place to Work' in 2021. Hindalco was also recognised as one of the 'Best Employers among Nation Builders' by the Great Place to Work Institute in 2022.

Through employee-centric systems and processes and capability and capacity building initiatives, we ensure the holistic development of our employees. Keeping in mind our strategic priority of value enhancing growth and to stay relevant in today's fast-changing world, investing in talent development and transforming key elements of culture has been our focus in the past few years. Our Shillim movement, now in its fifth edition, focuses on further strengthening a contemporary culture that is centred around ownership, openness, inclusion, collaboration, and meritocracy. Given the competitive job environment, we have further strengthened our talent retention strategy through various initiatives to retain our top performing employees. Our multi-pronged talent management strategy focuses on hiring young talent, creating structured training and development initiatives, promoting gender diversity, and building technical and specialist capability. Our human rights policy safeguards our employees and contractual

workmen against harassment and discrimination. We have made focused efforts to enhance employee productivity through various tailored programmes focusing on their wellbeing. By investing in people and culture we continue to inspire our workforce to go above and beyond and deliver consistent superior performance in the most challenging times.

Details of our initiatives and performance are provided in the 'Our Capitals' section of this report.

## 9. Internal Controls & their Adequacy

A strong culture of internal controls is pervasive throughout the Group. Regular internal audits at all locations are undertaken to ensure that the highest standards of internal control are maintained. The effectiveness of a business' internal control environment is a component of senior management performance appraisals. The principal aim of the internal control system is the management of business risks with a view to enhance shareholder value and safeguard the Group's assets. It provides reasonable assurance on the internal control environment and against material misstatement or loss. The Company has in place a robust mechanism to deal with Internal audit that involves having a dedicated Assurance & Control function having personnel specialised in the field of the subject and having two internal auditors duly appointed by the Audit Committee and Board., viz. M/s. Ernst & Young for the Aluminium Business and M/s. Suresh Surana & Associates for the Copper business. The Audit Committee discusses audit plans, findings and observations made by the internal auditors at its meetings. The findings made by the internal auditors are reviewed and suggestions implemented.

### Cautionary Statement

Statements in this "Management Discussion and Analysis" describing the Company's objectives, projections, estimates, expectations or predictions may be "forward looking statements" within the meaning of applicable securities laws and regulations. Actual results could differ materially from those expressed or implied. Important factors that could make a difference to the Company's operations include global and Indian demand supply conditions, finished goods prices, feedstock availability and prices, cyclical demand and pricing in the Company's principal markets, changes in the government regulations, tax regimes, economic developments within India and the countries within which the Company conducts business and other factors such as litigation and labour negotiations. The Company assumes no responsibility to publicly amend, modify or revise any forward looking statements, on the basis of any subsequent development, information events or otherwise.

# Financial Highlights - Consolidated

(₹ Crore)

	2021-22 <sup>o</sup>	2021-22 <sup>o</sup>	2020-21 <sup>o</sup>	2019-20 <sup>o</sup>	2018-19 <sup>o</sup>	2017-18 <sup>o</sup>	2016-17 <sup>o</sup>	2015-16 <sup>o</sup>	2014-15	2013-14	2012-13
<b>Profitability</b>	US\$ in Mn*										
Sales and Operating Revenues	26,185	195,059	131,985	118,144	130,542	115,820	102,631	101,202	106,696	90,007	82,243
Less: Cost of Sales	22,359	166,557	114,311	103,794	115,042	101,899	90,183	92,387	97,751	81,721	74,406
Operating Profit	3,826	28,502	17,674	14,350	15,500	13,921	12,448	8,815	8,944	8,286	7,837
Other Income	152	1,136	1,222	1,186	1,127	1,105	1,111	1,189	1,105	1,017	1,012
Less: Depreciation, Amortization and Impairment	924	6,884	6,766	5,135	4,766	4,607	4,469	4,507	3,591	3,553	2,861
Less: Interest and Finance Charges	506	3,768	3,738	4,197	3,778	3,911	5,742	5,134	4,178	2,702	2,079
Profit before Share in Equity Accounted Investments, Exceptional Items and Tax	2,548	18,986	8,392	6,204	8,083	6,508	3,348	362	2,280	3,049	3,909
Share in Profit/ (Loss) in Equity Accounted Investments (Net of Tax)	1	6	5	4	-	(125)	(25)	172	175	67	(16)
Profit before Tax and Exceptional Items	2,549	18,992	8,397	6,208	8,083	6,383	3,323	534	2,455	3,116	3,893
Exceptional Income/(Expenses) (Net)	78	582	(492)	(284)	-	1,774	(8)	(577)	(1,940)	(396)	-
Profit/ (Loss) before Tax from Continuing Operations	2,627	19,574	7,905	5,924	8,083	8,157	3,315	(43)	515	2,720	3,893
Less: Tax Expenses	721	5,373	2,723	2,157	2,588	2,074	1,433	498	256	525	886
Profit/ (Loss) from Continuing Operations	1,906	14,201	5,182	3,767	5,495	6,083	1,882	(541)	258	2,195	3,007
Profit/ (Loss) from Discontinued Operations (Net of Tax)	(63)	(471)	(1,699)	-	-	-	-	(161)	-	-	-
Profit/ (Loss) before Non-Controlling Interest	1,843	13,730	3,483	3,767	5,495	6,083	1,882	(702)	258	2,195	3,007
Less: Non-Controlling Interest in Profit/ (Loss)	-	-	-	-	(1)	-	(18)	(451)	(596)	20	(20)
Net Profit/ (Loss) for the Period	1,843	13,730	3,483	3,767	5,496	6,083	1,900	(251)	854	2,175	3,027
<b>Business Reconstruction Reserve (BRR) #</b>											
Expenses adjusted against BRR (Net of Tax)	-	-	-	-	-	-	-	682	97	86	-
Profit/ (Loss) for the Period had the expenses not adjusted against BRR	1,843	13,730	3,483	3,767	5,496	6,083	1,900	(933)	757	2,089	3,027

## Financial Position

Gross Fixed Assets (excluding CWIP)	22,385	169,911	157,052	140,334	130,142	25,094	121,186	123,522	101,940	87,914	60,054
Capital Work-in-Progress (CWIP) **	651	4,945	10,202	7,721	4,098	2,063	1,814	4,214	14,111	23,059	33,834
Less: Accumulated Depreciation, Amortization and Impairment	8,305	63,037	56,783	51,139	44,283	40,006	36,499	37,849	29,981	26,750	22,126
Net Fixed Assets	14,731	111,819	110,471	96,916	89,957	87,151	86,501	89,887	86,070	84,223	71,763
Investments	1,860	14,119	17,133	9,411	9,012	10,781	15,157	12,438	12,346	12,961	12,601
Other Non-Current Assets /(Liabilities) (Net)	(1,570)	(11,920)	(11,794)	(12,407)	(9,581)	(8,497)	(6,737)	(8,859)	(7,235)	(6,924)	(6,573)
Net Current Assets	3,612	27,417	16,711	31,664	20,538	17,499	14,961	15,074	16,571	18,289	16,901
Capital Employed	18,633	141,435	132,521	125,584	109,926	106,934	109,882	108,540	107,752	108,549	94,692
Less: Loan Funds	8,331	63,235	65,978	67,257	52,416	52,074	63,817	67,552	68,467	66,163	57,603
Less: Non-Controlling Interest	1	11	10	10	9	9	6	381	956	1,781	1,759
Net Worth	10,301	78,189	66,533	58,317	57,501	54,851	46,059	40,607	38,329	40,605	35,330

(₹ Crore)

	2021-22 <sup>o</sup>	2021-22 <sup>o</sup>	2020-21 <sup>o</sup>	2019-20 <sup>o</sup>	2018-19 <sup>o</sup>	2017-18 <sup>o</sup>	2016-17 <sup>o</sup>	2015-16 <sup>o</sup>	2014-15	2013-14	2012-13
<b>Net Worth represented by :</b>											
Equity Share Capital	29	222	222	222	222	223	223	205	207	206	191
Other Equity:											
Share Warrants	-	-	-	-	-	-	-	-	-	6	541
Equity Component of Compound Financial Instruments	1	4	4	4	4	4	4	3	-	-	-
Reserves and Surplus	9,731	73,860	59,717	55,577	52,599	47,644	41,770	36,443	38,122	40,393	34,597
Other Comprehensive Income	541	4,105	6,590	2,514	4,676	6,980	4,062	3,956	-	-	-
	10,302	78,191	66,533	58,317	57,501	54,851	46,059	40,607	38,329	40,605	35,330

## Ratios and Statistics

	Unit	2021-22 <sup>o</sup>	2020-21 <sup>o</sup>	2019-20 <sup>o</sup>	2018-19 <sup>o</sup>	2017-18 <sup>o</sup>	2016-17 <sup>o</sup>	2015-16 <sup>o</sup>	2014-15	2013-14	2012-13
Operating Margin	%	14.61	13.41	12.15	11.87	12.02	12.13	8.71	8.38	9.21	9.53
Net Margin	%	7.04	2.64	3.19	4.21	5.25	1.85	(0.25)	0.80	2.42	3.68
Gross Interest Cover ^	Times	7.49	4.73	3.57	4.37	3.86	2.36	1.91	1.95	1.85	2.04
Net Interest Cover^^	Times	7.87	5.06	3.70	4.40	3.84	2.36	1.95	2.41	3.44	4.26
ROCE <sup>^^^</sup>	%	16.61	9.40	8.83	10.94	9.61	8.32	5.08	5.97	5.66	7.07
ROE	%	18.97	5.58	6.51	9.78	12.06	4.39	(0.64)	2.16	5.73	9.00
Basic EPS	₹	61.73	15.66	16.94	24.67	27.30	9.22	(4.55)	4.14	10.91	15.81
Diluted EPS	₹	61.65	15.65	16.93	24.66	27.29	9.22	(4.55)	4.13	10.91	15.81
Cash EPS <sup>^^^^</sup>	₹	92.69	46.07	40.03	46.07	47.98	30.91	20.78	21.53	28.73	30.75
Capital Expenditure (Cash outflow)	₹ Crore	5,426	5,565	6,791	6,005	3,001	2,938	4,245	5,978	9,424	11,871
Debt Equity Ratio	Times	0.81	0.99	1.15	0.91	0.95	1.39	1.66	1.79	1.63	1.63
Book value per Share	₹	347.86	296.07	259.56	256.07	244.33	205.32	196.64	185.61	196.67	184.53

\* Balance Sheet items are translated at closing exchange rate and Profit and Loss items are translated at average exchange rate.

\*\* Including Intangible assets under development.

# Financial restructuring scheme formulated by the Company under the provisions of the Companies Act, approved by the Bombay High Court, to deal with various costs associated with its organic and inorganic growth plan.

@ Figures for FY 2021-22, FY 2020-21, FY 2019-20, FY 2018-19, FY 2017-18, FY 2016-17 and FY 2015-16 are as per Ind AS compliant financial statements. Previous periods figures are as per Previous GAAP financial statements.

^ Gross interest coverage ratio is calculated as Operating Profit plus Other Income divided by Interest and Finance Charges plus Finance costs transferred to Capital Work-in-Progress/ Intangible Assets under development.

^^ Net interest coverage ratio is calculated as Operating Profit plus Other Income divided by Interest and Finance Charges.

^^^ Earnings before Interest and Taxes/ Average Capital Employed.

^^^^ Cash EPS is calculated as Profit/ (Loss) for the year plus Depreciation, Amortization and Impairment divided by Weighted average numbers of equity shares.



# Financial Highlights - Standalone

(₹ Crore)

	2021-22	2021-22 <sup>o</sup>	2020-21 <sup>o</sup>	2019-20 <sup>o</sup>	2018-19 <sup>o</sup>	2017-18 <sup>o</sup>	2016-17 <sup>o</sup>	2015-16 <sup>o</sup>	2014-15	2013-14	2012-13
<b>Profitability</b>	US\$ in Mn *										
Sales and Operating Revenues	9,082	67,653	42,701	40,242	45,749	43,446	39,383	36,713	36,869	30,101	28,070
Less: Cost of Sales	7,566	56,360	38,467	36,578	41,503	38,322	34,569	33,367	33,453	27,609	25,866
Operating Profit	1,516	11,293	4,234	3,664	4,246	5,124	4,814	3,346	3,417	2,492	2,204
Other Income	72	535	650	739	940	948	1,005	979	882	1,124	983
Less: Depreciation, Amortization and Impairment	248	1,847	1,848	1,708	1,693	1,617	1,428	1,282	837	823	704
Less: Interest and Finance Charges	190	1,417	1,469	1,679	1,683	1,901	2,323	2,390	1,637	712	436
Profit before Exceptional Items and Tax	1,150	8,564	1,567	1,016	1,810	2,554	2,068	653	1,825	2,081	2,047
Exceptional Income/ (Expenses) (Net)	(14)	(107)	7	(64)	-	(325)	85	-	(578)	(396)	-
Profit/ (Loss) before Tax from Continuing Operations	1,135	8,457	1,574	952	1,810	2,229	2,153	653	1,247	1,685	2,047
Less: Tax Expenses	396	2,950	581	332	605	793	596	99	322	272	347
Profit/ (Loss) from Continuing Operations	739	5,507	993	620	1,205	1,436	1,557	554	925	1,413	1,699
Profit/ (Loss) from Discontinued Operations (Net of Tax)	-	-	-	-	-	-	(2)	-	-	-	-
Profit/ (Loss) for the Period	739	5,507	993	620	1,205	1,436	1,557	552	925	1,413	1,699
<b>Business Reconstruction Reserve (BRR) #</b>											
Expenses adjusted against BRR (Net of Tax)	-	-	-	-	-	-	-	682	97	86	-
Profit/ (Loss) for the Period had the expenses not adjusted against BRR	739	5,507	993	620	1,205	1,436	1,557	(130)	828	1,327	1,699
<b>Financial Position</b>											
Gross Fixed Assets (excluding CWIP)	6,917	52,507	51,080	50,296	48,898	48,264	46,742	43,316	35,434	26,804	15,073
Capital Work-in-Progress (CWIP) **	208	1,581	1,709	1,282	982	737	712	3,079	10,744	17,277	23,605
Less: Accumulated Depreciation, Amortization and Impairment	2,662	20,207	18,690	16,928	15,376	13,900	12,358	11,063	9,374	8,749	7,975
Net Fixed Assets	4,464	33,881	34,099	34,650	34,504	35,101	35,096	35,332	36,804	35,332	30,703
Investments	3,907	29,655	31,731	24,639	25,495	27,025	29,332	27,311	21,251	21,907	20,482
Other Non-Current Assets /(Liabilities) (Net)	(458)	(3,473)	(2,365)	(2,223)	(1,565)	(708)	516	(1,038)	(1,193)	(1,174)	(751)
Net Current Assets	1,771	13,444	6,528	11,478	9,658	8,330	9,539	9,230	9,400	8,339	8,409
Capital Employed	9,684	73,507	69,993	68,544	68,092	69,748	74,483	70,835	66,262	64,404	58,843
Less: Loan Funds	2,514	19,079	19,929	23,050	19,534	20,297	27,150	28,676	29,007	27,672	24,871
Net Worth	7,171	54,428	50,064	45,494	48,558	49,451	47,333	42,159	37,255	36,732	33,972

(₹ Crore)

	2021-22	2021-22 <sup>o</sup>	2020-21 <sup>o</sup>	2019-20 <sup>o</sup>	2018-19 <sup>o</sup>	2017-18 <sup>o</sup>	2016-17 <sup>o</sup>	2015-16 <sup>o</sup>	2014-15	2013-14	2012-13
<b>Net Worth represented by :</b>											
Equity Share Capital	29	222	222	222	222	223	223	205	207	206	191
Other Equity:											
Share Warrants	-	-	-	-	-	-	-	-	-	-	541
Reserves and Surplus	6,479	49,178	44,310	43,482	43,285	42,497	41,235	36,568	37,049	36,526	33,240
Other Comprehensive Income	662	5,028	5,532	1,790	5,051	6,731	5,875	5,386	-	-	-
	7,171	54,428	50,064	45,494	48,558	49,451	47,333	42,159	37,255	36,732	33,972

## Ratios and Statistics

	Unit	2021-22 <sup>o</sup>	2020-21 <sup>o</sup>	2019-20 <sup>o</sup>	2018-19 <sup>o</sup>	2017-18 <sup>o</sup>	2016-17 <sup>o</sup>	2015-16 <sup>o</sup>	2014-15	2013-14	2012-13
Operating Margin	%	16.69	9.92	9.11	9.28	11.79	12.22	9.11	9.27	8.28	7.85
Net Margin	%	8.14	2.33	1.54	2.63	3.31	3.95	1.50	2.51	4.70	6.05
Gross Interest Cover ^	Times	8.20	3.29	2.62	3.08	3.18	1.73	1.81	1.75	1.50	1.61
Net Interest Cover^^	Times	8.35	3.32	2.62	3.08	3.19	2.51	1.81	2.63	5.08	7.31
ROCE^^^	%	13.91	4.38	3.94	5.07	6.18	6.04	4.44	5.30	4.53	4.71
ROE	%	10.54	2.08	1.32	2.46	2.97	3.48	1.39	2.50	4.00	5.15
Basic EPS	₹	24.76	4.46	2.79	5.41	6.45	7.56	(0.64)	4.48	7.09	8.88
Diluted EPS	₹	24.73	4.46	2.79	5.41	6.45	7.55	(0.64)	4.48	7.09	8.87
Cash EPS ^^^^	₹	33.07	12.77	10.47	13.01	13.70	14.49	8.95	8.53	11.22	12.55
Dividend per Share ^^	₹	4.00	3.00	1.00	1.20	1.20	1.10	1.00	1.00	1.00	1.40
Capital Expenditure (Cash outflow)	₹ Crore	1,506	1,137	1,395	1,263	1,178	1,041	1,399	2,073	3,458	5,531
Debt Equity Ratio	Times	0.36	0.40	0.51	0.40	0.41	0.57	0.68	0.78	0.75	0.73
Book value per Share	₹	242.16	222.84	202.49	216.25	220.28	211.00	204.16	180.41	177.92	177.44
Market Capitalisation <sup>5</sup>	₹ Crore	127,976	73,433	21,502	46,145	48,166	43,756	18,162	26,638	29,266	17,538
Number of Equity Shareholders	Nos.	503,729	348,471	332,014	304,345	299,521	319,783	392,888	338,655	361,686	441,166
Number of Employees	Nos.	21,151	20,971	22,477	22,865	23,555	23,679	24,118	21,976	20,902	20,238
Average Cash LME (Aluminium)	US\$	2,769	1,802	1,749	2,035	2,046	1,688	1,592	1,888	1,773	1,976
Average Cash LME (Copper)	US\$	9,691	6,879	5,855	6,337	6,451	5,152	4,852	6,556	7,103	7,855

\* Balance Sheet items are translated at closing exchange rate and Profit and Loss items are translated at average exchange rate.

\*\* Including Intangible assets under development

# Financial restructuring scheme formulated by the Company under the provisions of the Companies Act, approved by the Bombay High Court, to deal with various costs associated with its organic and inorganic growth plan.

## Proposed/Interim Dividend for the Period

@ Figures for FY 2021-22, FY 2020-21, FY 2019-20, FY 2018-19, FY 2017-18, FY 2016-17 and FY 2015-16 are as per Ind AS compliant financial statements. Previous periods figures are as per Previous GAAP financial statements.

\$ including Treasury shares held by the Company

^ Gross interest coverage ratio is calculated as Operating Profit plus Other Income divided by Interest and Finance Charges plus Finance costs transferred to Capital Work-in-Progress/ Intangible Assets under development.

^^ Net interest coverage ratio is calculated as Operating Profit plus Other Income divided by Interest and Finance Charges.

^^^ Earnings before Interest and Taxes/ Average Capital Employed.

^^^^ Cash EPS is calculated as Profit/ (Loss) for the year plus Depreciation, Amortization and Impairment divided by Weighted average numbers of equity shares.

# Directors' Report

Dear Shareholders,

Your Directors have pleasure in presenting the 63<sup>rd</sup> Annual Report and the audited standalone and consolidated financial statements of your company for the year ended 31st March, 2022.

## Financial Highlights

	Consolidated		Standalone	
	2021-22	2020-21	2021-22	2020-21
	₹ in Crore			
<b>Revenue from Operations</b>	<b>1,95,059</b>	<b>1,32,008</b>	<b>67,653</b>	<b>42,701</b>
Other Income	1,136	1,199	535	650
<b>Profit Before Interest, Tax and Depreciation (PBITDA)</b>	<b>29,638</b>	<b>18,896</b>	<b>11,828</b>	<b>4,884</b>
Depreciation and Amortisation	6,729	6,628	1,752	1,708
Impairment Loss/(Reversal) of Non Current Assets (Net)	155	138	95	140
Finance Costs	3,768	3,738	1,417	1,469
Profit before Exceptional Items and Tax Share in Profit / (Loss) in Equity Accounted Investments	<b>18,986</b>	<b>8,392</b>	<b>8,564</b>	<b>1,567</b>
Share of Equity Accounted Investments	6	5	-	-
<b>Profit before Exceptional Items and Tax</b>	<b>18,992</b>	<b>8,397</b>	<b>8,564</b>	<b>1,567</b>
Exceptional Items	582	(492)	(107)	7
<b>Profit before Tax</b>	<b>19,574</b>	<b>7,905</b>	<b>8,457</b>	<b>1,574</b>
Tax Expenses	5,373	2,723	2,950	581
<b>Profit/ (Loss) for the year from Continuing Operations</b>	<b>14,201</b>	<b>5,182</b>	-	-
Profit/ (Loss) for the Year from Discontinued Operations	(464)	(2,066)	-	-
Tax Expense/ (Benefit) of Discontinued Operations	7	(367)	-	-
<b>Profit/ (Loss) for the year from Discontinued Operations</b>	<b>(471)</b>	<b>(1,699)</b>	-	-
Profit/ (Loss) for the year	<b>13,730</b>	<b>3,483</b>	<b>5,507</b>	<b>993</b>
Other Comprehensive Income / (Loss)	(1,148)	4,784	(397)	3,780
<b>Total Comprehensive Income</b>	<b>12,582</b>	<b>8,267</b>	<b>5,110</b>	<b>4,773</b>
Basic EPS - Continuing Operations (₹)	63.85	23.30	-	-
Basic EPS - Discontinued Operations (₹)	(2.12)	(7.64)	-	-
<b>Basic EPS (₹)</b>	<b>61.73</b>	<b>15.66</b>	<b>24.76</b>	<b>4.46</b>

## Appropriations to Reserves :

Appropriations	₹ in Crore	
	2021-22	2020-21
Opening Balance in Retained Earnings and Other Comprehensive Income	11,026	6,624
Total Comprehensive Income for the Current Year	5,110	4,773
Dividends paid	(667)	(222)
Hedging (Gain)/ Loss and cost of hedging transferred to non financial assets	(41)	(1)
Employee Share Based Transactions	2	2
Transferred to Debenture Redemption Fund	(150)	(150)
Closing Balance in Retained Earnings and Other Comprehensive Income	15,280	11,026

## Dividend:

For the year ended 31<sup>st</sup> March, 2022, the Board of Directors of your Company has recommended dividend of ₹ 4.00 per share (Previous year ₹ 3.00 per share) to equity shareholders.

Equity shares that may be allotted upon exercise of Options granted under the Employee Stock Option Scheme and out of the Share Capital Suspense before the Book Closure for payment of dividend will rank paripassu with the existing shares and shall also be entitled to receive the aforesaid dividend.

In terms of provisions of Regulation 43A of the Securities and Exchange Board of India (Listing Obligations & Disclosure Requirements) Regulations, 2015, herein after referred to as "Listing Regulations" your Company has formulated a Dividend Distribution Policy. The Policy is given in **Annexure I** to the Annual Report and is also accessible from your Company's Website [www.hindalco.com](http://www.hindalco.com).

## Overview and State of the Company's Affairs:

The Standalone and Consolidated Financial Statements for the Financial Year ended 31st March, 2022 have been prepared in accordance with the Indian Accounting Standards (IND AS) as notified by the Ministry of Corporate Affairs.

### Standalone full year highlights

Your Company registered a revenue of ₹ 67,653 crores for the fiscal year 2022 vs ₹ 42,701 crores in the previous year up 58% on account of higher global prices of aluminium and copper in FY22 versus EBITDA of ₹ 4,884 crores in FY21. EBITDA (Earnings before Interest, Tax, Depreciation and Amortisation) stood at ₹ 11,828 crores, up 142% compared to the last year, on account of higher profitability in Aluminium business supported by improved macros, higher volumes, and cost optimization. Depreciation was up 3% at ₹ 1,752 crore in FY22 versus ₹ 1,708 crores in FY21. The Finance Cost was lower on Year by 4% at ₹ 1,417 crores in FY22 versus ₹ 1,469 crores in FY21. This reduction in finance cost was mainly due to overall reduction in the average cost of long-term loans on account of re-financing. The Profit before Tax (and Before Exceptional Items) stood at ₹ 8,564 crore, up by 447% compared to the previous year due to higher EBITDA. Net Profit for FY22 stood at ₹ 5,507 crores as compared to ₹ 993 crore up 455% Year on Year compared to the previous year.

### Consolidated Full Year Highlights

Hindalco's Consolidated Revenue stood at ₹ 1,95,059 crore for FY22 compared to ₹ 1,32,008 crore in the previous year up 48% on account of higher global prices of aluminium and copper in FY22 versus FY21. The Company recorded consolidated EBITDA (Earnings before Interest, Tax, Depreciation and Amortisation) of ₹ 29,638 crore, up by 57% due to favorable macros, strategic product mix and an improved performance by the downstream business in FY22 versus FY21. Consolidated Profit before Tax (and Before Exceptional Items) was ₹ 18,992 crore in FY22, up by 126% compared to the previous year on account of higher EBITDA. Net Profit after Tax in FY22, stood at ₹ 13,730 crores compared to ₹ 3,483 crores in the previous year up 294% Year on Year on account of exceptional performance by India Business in FY22. For detailed analysis, refer to the Management Discussion and Analysis section of the Integrated Annual Report.

## Highlights of the Company's Subsidiaries:

### 1. Utkal Alumina International Limited

Utkal Alumina revenues were ₹ 4,594 crore in FY22 compared to ₹ 2,787 crore in FY21 up by 65% because of higher transfer pricing compared to last year on account of higher average global alumina prices in FY22 versus FY21. The EBITDA for FY22 stood at ₹ 2,215 crore higher by 62% compared to ₹ 1,371 crore in FY21. The Profit after Tax in FY22 was ₹ 1,099 crore versus ₹ 605 crore in FY21 up by 82% Year on Year on account of higher EBITDA in FY22. (Refer to the table below for comparison in FY22 versus FY21 key financial number).

Particulars (₹ in Crore)	FY22	FY21	% Change
Revenue	4,594	2,787	65%
EBITDA	2,215	1,371	62%
PAT	1,099	605	82%



# Directors' Report

## 2. Novelis Inc.

The Performance highlights of Novelis Inc. are provided in detail for FY22 versus FY21 in the Management Discussion and Analysis Section of the Integrated Annual Report.

### Key Initiatives

In India operations, Hindalco successfully completed its 500Kt Utkal's Alumina refinery brownfield capacity expansion in FY22. This project was at a capital outlay of around ₹ 1,500 crore. This has strengthened the Company's integration and boosted the availability of best-in-class alumina and in a reduction of the overall cost of production in FY22.

In FY22, Hindalco made two acquisitions valued \$79 million of Hydro's Kuppam Extrusion facility in India to expand its presence in the upper end of the value-added to enhance our capabilities in high-end extrusions and a fabricated solutions and a Copper CCR facility of Ryker (now Asoj) with capacity of 225 kt, expanding overall capacities in the value-added segment. This will not only enhance the Company's capabilities but also help the Company to move towards a more sustainable business model.

In addition to the above, Hindalco announced certain organic growth investments in India in the businesses of Aluminium, Copper, Specialty Alumina and also Resource Securitisation over the next five years in the range of \$3.0-3.3 billion, including some certain projects which are under appraisal. The company continues to focus on its downstream strategy to increase its downstream capacities in the Flat Rolled Products, Extrusions and other flat rolled products. All these investments are mainly targeted towards catering the rising demand of downstream products in the domestic market.

Novelis has identified more than \$4.5 billion of potential organic capital investment opportunities to grow Novelis' business through debottlenecking, recycling, and new capacity investments over the next five years focused on increasing capacity and capabilities that meet growing customer demand and align with its sustainability commitments. This includes expansion of cold rolling and recycling capacity in Zhenjiang, China, a highly advanced recycling center for automotive in the U.S. and a recycling center at UAL joint venture in South Korea.

This also includes Novelis' \$2.5 billion greenfield, fully integrated rolling and recycling plant in Bay Minette, Alabama. This new U.S. plant will support strong demand for sustainable beverage can and automotive aluminum sheet and advance towards a circular economy.

Novelis continues to focus on its safe integration of Aleris' continuing operations to drive several strategic benefits and is expected to generate over \$220 million in synergies, through traditional integration cost synergies and strategic synergies created by enhancing and integrating operations in Asia.

During the year, all these expansion projects are in line with Company's Capital Allocation framework, focussed on value enhancing growth, its product enrichment, maintaining a robust capital structure for maximising shareholder value.

### Human Resources:

Several innovative people - focused initiatives have been instituted at the Group level, and these are translated into action at all of the Group Companies. Our basic objective is to ensure that a robust talent pipeline and a high-performance culture, centred around accountability is in place. We feel this is critical to enable us retain our competitive edge.

### Research and Development

Your Company's Research & Development (R&D) activities are focused on developing and commercializing premium differentiated products, improving our competitive cost position, product quality and environmental sustainability. To support these goals, we are managing a pipeline of projects that address near and mid-term needs, as well as the exploration of future opportunities. This year R&D team continued development in the area of making our processes greener & sustainable and value added products & applications. These initiatives helped our plants to mitigate challenges of raw material quality, reducing specific energy consumption and carbon footprint, cost effective management of waste generated during processing, recovery of value from by-product as well as any waste products. Specific programs have also been initiated to adopt new digitalisation techniques such as soft sensors, digital twins, etc. The predictive and prescriptive models based on AI /ML data analytics coupled with physic based models are helping better process control & achieve desired process performance. These tools also help in understanding the requirement of existing and prospective customers, and provide a better service, in order to increase your company's market share in the chosen market space. Technical competencies developed by your company will go a long way in terms of quick absorption of technologies, enabling pushing boundaries of our processes, so as to increase the economic performance and improve our new product/new application pipeline to address the impending market opportunities.

Your Company already operates three Hindalco Innovation Centres (HIC), one HIC-Alumina at Belagavi working on R&D of bauxite ore, alumina refining and specialty alumina, hydrate products and their application in different end uses; as well as waste management; and one HIC-SemiFab located at Taloja, near Mumbai, working in the area of tribology, energy and environment management and aluminium fabricated products and new applications. Additionally, R&D Team at Birla Copper, Dahej, is focusing on maximisation of copper recovery as well recovery of various metal values, such as, Selenium, Tellurium, Nickel, Bismuth, etc., from the effluent generated in the plant and value added applications of the solid wastes. In addition, your company engages the Aditya Birla Group's corporate

research and development centre, Aditya Birla Science and Technology Company Private Limited ("ABSTCPL"), for conducting R&D in select areas of work through chartered R&D projects. These are based on the domain expertise and R&D facilities available in ABSTCPL. ABSTCPL's forte of having multidisciplinary teams of technical experts, scientists and engineers, enables your company to develop building competencies in select areas, as a long term value to business. Both the HICs at Belagavi and Taloja as well as ABSTCPL are DSIR, GOI recognised R&D Centres. Parallely, we also work with different R&D institutes of national and international reputes to develop technologies for our mutual benefits. The engagement has resulted into patent applications, which have been and will be assigned to your company on the grant of the patent.

### Consolidated Financial Statements:

The Consolidated Financial Statements for the year ended 31st March, 2022 have been prepared by your Company in accordance with the provisions of the Companies Act, 2013, read with the Companies (Accounts) Rules, 2014, applicable Accounting Standards and the provisions of Securities and Exchange Board of India (Listing Obligations and Disclosure Requirements) Regulations, 2015 "Listing Regulations" and forms part of the full Annual Report.

### Employee Stock Option Schemes:

#### ESOS – 2006

During the year ended 31st March 2022, the Company has allotted 391,304 fully paid-up equity share of ₹ 1/- each of the Company (Previous year 65,652) on exercise of options under ESOS 2006.

#### ESOS – 2013:

During the year ended 31st March 2022, the Company has allotted 97,173 fully paid-up equity share of ₹ 1/- each of the Company (Previous year 3,95,908) on exercise of options under ESOS 2013.

#### ESOS – 2018:

During the year, the Company has granted 18,72,984 stock options (Previous year 5,82,240) and 612,560 RSUs (Previous year 20,487) under ESOS 2018. Hindalco Employee Welfare Trust has transferred 8,78,968 fully paid-up equity share of ₹ 1/- each of the Company during the year on exercise of Options under ESOS 2018.

The details of Stock Options and Restricted Stock Units granted under the above-mentioned Schemes are available on your Company's website viz. [www.hindalco.com](http://www.hindalco.com).

A certificate from the statutory auditor on the implementation of your Company's Employees Secretarial Option Schemes will be placed at the ensuing Annual General Meeting for inspection by the members.

There is no material change in the Schemes and the aforementioned schemes are in compliance with SEBI (Share Based Employee Benefits) Regulations, 2014.

### Corporate Governance

Your Directors reaffirm their continued commitment to good corporate governance practices. Your Company fully adheres to the standards set out by the Securities and Exchange Board of India for Corporate Governance practices.

The entire report on Corporate Governance forms part of Integrated Annual Report.

### Directors' Responsibility Statement

As stipulated in Section 134(3)(c) of the Companies Act, 2013 ("the Act"), your Directors subscribe to the "Directors' Responsibility Statement" and confirm that:

- in the preparation of the annual accounts, applicable accounting standards have been followed along with proper explanations relating to material departures;
- the accounting policies selected have been applied consistently and judgments and estimates have been made that are reasonable and prudent so as to give a true and fair view of the state of affairs of the company as at 31st March, 2022 and of the profit of your company for that period;
- proper and sufficient care has been taken for the maintenance of adequate accounting records in accordance with the provisions of the Act for safeguarding the assets of your company and for preventing and detecting fraud and other irregularities;
- the annual accounts of your Company have been prepared on a going concern basis;
- your Company had laid down internal financial controls and that such internal financial controls are adequate and were operating effectively;
- your Company has devised proper system to ensure compliance with the provisions of all applicable laws and that such systems were adequate and operating effectively.

### Energy, Technology and Foreign Exchange:

The information on conservation of Energy, Technology Absorption and Foreign Exchange Earnings and Outgo stipulated under Section 134(3)(m) of the Companies Act, 2013, read with Companies (Accounts) Rules, 2014 is set out in **Annexure II** to this Report.

# Directors' Report

## Particulars of Employees:

In accordance with the provisions of Section 197(12) of the Companies Act, 2013 ("the Act"), read with the Companies (Appointment and Remuneration of Managerial Personnel) Rules, 2014, the names and other particulars of employees are to be set out in the Directors' Report, as an addendum thereto. However, in line with the provisions of Section 136(1) of the Act, the Report and Accounts as set out therein, are being sent to all Members of your Company excluding the aforesaid information about the employees. Any Member, who is interested in obtaining these particulars about employees, may write to the Company Secretary at the Registered Office of your Company.

Disclosures pertaining to remuneration and other details as required under section 197(12) read with Companies (Appointment and Remuneration of Managerial Personnel) Rules, 2014 are attached as **Annexure III** to the Integrated Annual Report.

## Directors:

### Board constitution and changes:

Mr. Kumar Mangalam Birla (DIN: 00012813) will retire from office by rotation at Annual General Meeting, and being eligible, offers himself for reappointment. Mr. Kumar Mangalam Birla has given required declaration under Companies Act, 2013.

Mr. Praveen Kumar Maheshwari (DIN:00174361) is re-appointed as the Whole-time Director for a term of 1 Year w.e.f. 28th May, 2022, subject to shareholders approval at the ensuing Annual General Meeting. He is also the Chief Financial Officer of the Company.

Brief resume of the Directors being appointed and re-appointed form part of the Notice of the ensuing Annual General Meeting.

The Board recommends, re-appointment of Mr. Kumar Mangalam Birla and Mr. Praveen Kumar Maheshwari. Item seeking your approval is included in the Notice convening the Annual General Meeting.

Brief resumes of the directors being appointed/ reappointed form part of the notice of the ensuing Annual General Meeting.

All the directors being appointed/reappointed have given required declaration under Companies Act, 2013 and Listing Regulations.

### Independent Directors Statement:

Independent Directors on your Company's Board have submitted declarations of independence to the effect that they meet the criteria of independence as provided in Section 149(6) of the Companies Act, 2013 and Regulation 16(1)(b) of the Listing Regulations.

## Policy on appointment and remuneration of Directors and Key Managerial Personnel:

The Nomination and Remuneration Committee has formulated the remuneration policy of your company which is attached as **Annexure IV** to the Integrated Annual Report.

## Meetings of the Board:

The Board of Directors of your Company met Seven times during the year, details of which are given in the Corporate Governance Report forming part of the Integrated Annual Report.

## Annual Evaluation:

Pursuant to the provisions of the Companies Act, 2013 and Securities and Exchange Board of India (Listing and Disclosures Requirement) Regulations, 2015, the Directors has carried annual performance evaluation of Board, Independent Directors, Non Executive Directors, Executive Directors, Committee and Chairman of the Board.

The evaluation framework focused on various aspects of the Board and Committees such as review, timely information from management etc. Also, the performance of individual directors was divided into Executive, Non Executive and Independent Directors and based on the parameters such as contribution, attendance, decision making, action oriented, external knowledge etc.

Board members have evaluated Independent Directors, Non executive Directors, Executive Directors, Committee and Chairman of the Board. The result of evaluation was satisfactory and meets the requirements of the Company. Board fully agreed and rated 100% on its functioning, skill sets and working atmosphere. Independent Directors scored well on expressing their views and in understanding the Company and its requirements. Non-Executive Directors scored well in understanding the Company and its requirements and keep themselves current on the areas to be discussed. Executive Directors are action oriented and ensures timely implementation of the Board decisions. Board is completely satisfied with the functioning of various Committees. Board has full faith in the Chairman in leading the Board effectively and ensuring contribution from all its members.

## Audit Committee:

The Audit Committee comprises Mr. K.N. Bhandari, Independent Director, Mr. Vikas Balia, Independent Director & Mr. Y.P. Dandiwala, Independent Director. Mr. Satish Pai :Managing Director and Mr. Praveen Kumar Maheshwari: Chief Financial Officer and Whole-Time Director are the permanent invitees. Further details relating to the Audit Committee are provided in the Corporate Governance Report forming part of the Integrated Annual Report.

## Key Managerial Personnel:

In terms of provisions of Section 203 of the Companies Act, 2013, Mr. Satish Pai: Managing Director, Mr. Praveen Kumar Maheshwari : Chief Financial Officer and Whole Time Director and Mr. Anil Malik: Company Secretary are the Key Managerial Personnel of your Company.

## Vigil Mechanism:

Your Company has in place a vigil mechanism for directors and employees to report concerns about unethical behaviour, actual or suspected fraud or violation of your Company's Code of Conduct. Adequate safeguards are provided against victimisation to those who avail of the mechanism and direct access to the Chairman of the Audit Committee in exceptional cases is provided to them.

The vigil mechanism is available on your Company's website viz. [www.hindalco.com](http://www.hindalco.com).

## Auditors

### Statutory Auditors

M/s. Price Waterhouse & Co. Chartered Accountants LLP (ICAI Registration No. 304026E/E-300009) were appointed as the Statutory Auditors of the company to hold office from the conclusion of Fifty Eighth Annual General Meeting held in 2017 till the conclusion of the Sixty third Annual General Meeting of the Company, to be held in the Calendar year 2022.

The Company has received confirmation from the Auditors to the effect that their appointment, if made, will be in accordance with the limits specified under the Companies Act, 2013 and the firm satisfies the criteria specified in Section 141 of the Companies Act, 2013 read with Rule 4 of Companies (Audit & Auditors) Rules 2014.

The Board is of the opinion that continuation of M/s. Price Waterhouse & Co. Chartered Accountants LLP, as Statutory Auditors will be in the best interests of the Company and therefore, the members are requested to consider their re-appointment as Statutory Auditors of the Company, for a term of five years, from the conclusion of the ensuing Annual General Meeting, till the Annual General Meeting to be held in the calendar year 2027, at such remuneration mutually agreed and approved by the Board.

The observation made in the Auditor's Report are self-explanatory and therefore, do not call for any further comments under Section 134(3)(f) of the Act.

### Cost Auditors

In terms of the provisions of Section 148 of the Act read with the Companies (Cost Records and Audit) Amendment Rules, 2014, the Board of Directors of your Company have

on the recommendation of the Audit Committee, appointed M/s. Nanabhoy & Co., Cost Accountants, Mumbai as Cost Auditors, to conduct the cost audit of your Company for the financial year ending 31st March, 2023, at a remuneration as mentioned in the Notice convening the Annual General Meeting. As required under the Act, the remuneration payable to the cost auditor is required to be placed before the Members in a general meeting for their ratification. Accordingly, a resolution seeking Member's ratification for the remuneration payable to Cost Auditors forms part of the Notice of the ensuing Annual General Meeting.

### Secretarial Auditors

Pursuant to provisions of Section 204 of the Companies Act, 2013 read with the Companies (Appointment and Remuneration of Managerial Personnel) Rules, 2014, the Company has appointed BNP & Associates, Company Secretaries, Mumbai as Secretarial Auditor for conducting the Secretarial Audit of your Company for the financial year ended 31st March, 2022. The Report of the Secretarial Auditors is annexed herewith as **Annexure V** to the Integrated Annual Report.

The Secretarial Audit Report does not contain any qualification, reservation or adverse remark.

As per Regulation 24A of the Listing Regulations, material unlisted subsidiaries of a listed entity incorporated in India is required to annex a Secretarial Audit Report issued by a Company Secretary in practice. In compliance with the above requirement, the Secretarial Audit Report of Utkal Alumina International Limited, a material subsidiary of your Company, is given in **Annexure VB** to the Annual Report. The Secretarial Audit Report do not contain any qualification, reservation or adverse remark.

## Environment Protection and Pollution Control

Your Company is committed to sustainable development. A detailed report of the Company's initiatives and commitment to environment conservation is part of the Integrated Annual Report.

## Particulars of Loans, Guarantees and Investments:

Details of Loans, Guarantee and Investments covered under the provisions of Section 186 of the Companies Act, 2013 read with Companies (Meetings of Board and its Powers) Rules, 2014 are given in the notes to Financial Statements of the Integrated Report.

## Corporate Social Responsibility:

In terms of the provisions of Section 135 of the Companies Act, 2013 ("the Act") read with Companies (Corporate Social Responsibility Policy) Rules, 2014, the Board of Directors of your Company has constituted a Corporate Social Responsibility



# Directors' Report

("CSR") Committee which is chaired by Mrs. Rajashree Birla. The other Members of the Committee for the Financial year ending 31<sup>st</sup> March 2022 were Mr. Y.P. Dandiwala, Independent Director, Mr. A.K. Agarwala, Non Executive Director and Mr. Satish Pai: Managing Director. Dr. Pragnya Ram, Group Executive President, Corporate Communication & CSR is a permanent invitee to the Committee.

Your Company also has in place a CSR Policy and the same is available on your Company's website viz. [www.hindalco.com](http://www.hindalco.com). The Committee recommends to the Board activities to be undertaken during the year.

Your Company is a caring corporate citizen and lays significant emphasis on development of the communities around which it operates. Your Company has identified several projects relating to Social Empowerment & Welfare, Infrastructure Development, Sustainable Livelihood, Health Care and Education during the year and initiated various activities in neighbouring villages around plant locations. During the financial Year 2021-22 the Company has spent ₹ 38 Crores under Section 135 of the Companies Act, 2013 on CSR activities, which is more than 2% of average net profits of the Company for immediately preceeding three financial years.

The Annual Report on CSR activities is attached as **Annexure VI** to the full Annual Report.

## Risk Management

Pursuant to the requirement of Securities and Exchange Board of India (Listing and Disclosures Requirement) Regulations, 2015, the Company has constituted Risk Management Committee, which is mandated to review the risk management plan/process of your company.

Risk evaluation and management is an ongoing process within the Organization. Your Company has comprehensive risk management policy which is periodically reviewed by the Risk Management Committee.

## Contracts and Arrangements with Related Parties

During the financial year, your Company entered into related party transactions which were on arm's length basis and in the ordinary course of business. There are no material transactions with any related party as defined under Section 188 of the Act read with Companies (Meetings of Board and its Powers) Rules, 2014 and SEBI (Listing Obligations and Disclosures Requirement) Regulations, 2015. The related party transactions have been approved by the Audit Committee and Board of your Company, as required under the Companies Act 2013 and SEBI (Listing Obligations and Disclosure Requirement) Regulations, 2015.

The policy on Related Party Transactions as approved by the Audit Committee and the Board is available on your Company's website viz. [www.hindalco.com](http://www.hindalco.com).

## Extract of Annual Return:

In terms of the provisions of Section 92 (3) of the Companies Act, 2013 ("the Act") read with the Companies (Management and Administration) Rules, 2014, an extract of the Annual Return of your Company for the financial year ended 31<sup>st</sup> March 2022 is available at [www.hindalco.com](http://www.hindalco.com).

## Business Responsibility Report:

As per Listing Regulations, a separate section of Business Responsibility Report forms part of Integrated Annual Report.

## Internal Control System and Their Adequacy:

Your Company has an Internal Control System, commensurate with the size, scale and complexity of its operations. The scope and authority of the Internal Audit (IA) function is defined by the Audit Committee.

The Internal Audit Department monitors and evaluates the efficacy and adequacy of internal control system in the Company, its compliance with operating systems, accounting procedures and policies at all locations of the Company.

Based on the report of internal auditors, the process owners undertake corrective action in their respective areas and thereby strengthen the controls. Significant audit observations and corrective actions thereon are presented to the Audit Committee of the Board.

## Internal Financial Control

Your directors confirm having laid down internal financial controls and that such internal financial controls are adequate and were operating effectively

## Subsidiary, Joint Ventures or Associate Companies:

The financial statements of your Company's subsidiaries and related information have been placed on the website of your Company viz. [www.hindalco.com](http://www.hindalco.com)

In accordance with the provisions of the section 129 (3) of the Act, read with the Companies (Accounts) Rules, 2014, a report on the performance and financial position of each of the subsidiaries, associates and Joint Venture is attached as **Annexure VII** to this Report.

The names of Companies which have become or ceased to be subsidiaries, Joint Ventures and associates are also provided in the aforesaid statement.

## Other Disclosures:

- There were no material changes and commitments affecting the financial position of your Company between end of financial year and the date of report.
- Your Company has not issued any shares with differential voting.
- There was no revision in the financial statements.
- Your Company has not issued any sweat equity shares.
- Mr. Satish Pai is a director on the Board of Novelis Inc, wholly owned subsidiary. He is in receipt of annual fee of US\$ 1,50,000 in the calendar year 2022. Mr. Praveen Kumar Maheshwari: Whole Time Director and Chief Financial Officer has not received any commission/ Remuneration from your Company's subsidiaries.
- There is no change in the nature of business.
- During the year under review, your Company has not accepted any fixed deposits from the public falling under Section 73 of the Act read with the Companies (Acceptance of Deposits) Rules, 2014. Thus, as on March 31, 2022, there were no deposits which were unpaid or unclaimed and due for repayment.
- There are no significant and material orders passed by the regulators or courts or tribunals impacting the going concern status and company's operations in future.
- There were no frauds reported by the Auditors u/s 143(12) of the Companies Act, 2013.

- As per the requirement of the Sexual Harassment of Women at the Workplace (Prevention, Prohibition and Redressal) Act, 2013, your Company has complied with provisions relating to the constitution of Internal Complaint Committee under POSH.
- Directors of your Company hereby state and confirm that the Company has complied with all the applicable Secretarial Standards.

## Appreciation

Your Directors place on record their sincere appreciation for the assistance and guidance provided by the Honorable Ministers, Secretaries and other officials of the Ministry of Mines, Ministry of Coal, the Ministry of Chemicals and Fertilizers and various State Governments. Your Directors thank the Financial Institutions and Banks associated with your Company for their support as well.

Your Company's employees are instrumental in your Company scaling new heights, year after year. Their commitment and contribution is deeply acknowledged.

Your involvement as Shareholders is greatly valued. Your Directors look forward to your continuing support.

For and on behalf of the Board

Satish Pai  
Managing Director  
DIN: 06646758

K.N. Bhandari  
Independent Director  
DIN: 00026078

Place: Mumbai  
Dated: 22nd July, 2022

# Annexure I

## Dividend Distribution Policy

### 1. Introduction

1.1. As per the SEBI (Listing Obligations and Disclosure Requirements) Regulations, 2015, as amended, the Company is required to formulate and disclose its Dividend Distribution Policy. Accordingly, the Board of Directors of the Company ('the Board') has approved this Dividend Distribution Policy for the Company at its meeting held on 13th February 2017 as amended on 22nd February 2021.

1.2. The objective of this policy is to provide clarity to stakeholders on the dividend distribution framework to be adopted by the Company. The Board of Directors shall recommend dividend in compliance with this policy, the provisions of the Companies Act, 2013 and Rules made thereunder and other applicable legal provisions.

### 2. Target Dividend Payout

2.1. Dividend will be declared for any financial year out of the profits of the company for that year or out of the profits of the company for any previous financial year or years arrived at after providing for depreciation and remaining undistributed, or out of both;

2.2. The Board will endeavor to distribute a dividend in the range of 8 % to 10% of the Free Cash Flow at Hindalco Consolidated Level (defined as Cash Flow after meeting interest, tax, other statutory dues, maintenance capital expenditure and working capital requirements at Hindalco Consolidated Level but before considering strategic capital expenditure and debt repayments/pre-payments) of the relevant year subject to compliances of the Companies Act 2013 and all other applicable Regulations.

### 3. Factors to be Considered for Dividend Payout

The Board will consider various internal and external factors, including but not limited to the following before making any recommendation for dividends:

- Free Cash Flow of the relevant year (as defined above)
- Stability of earnings
- Future capital expenditure, inorganic growth plans and reinvestment opportunities
- Industry outlook and stage of business cycle for underlying businesses
- Leverage profile and capital adequacy metrics
- Overall economic / regulatory environment
- Contingent liabilities
- Past dividend trends
- Buyback of shares or any such alternate profit distribution measure
- Any other contingency plans

### 4. Review

This policy would be subject to revision / amendment on a periodic basis as may be necessary.

### 5. Disclosure

This policy (as amended from time to time) will be available on the company's website and in the annual report.

Original date of Board Meeting where the Policy was approved 13th February, 2017

Board Meeting approval date for this revised policy 22nd February, 2021.

# Annexure II

## Part A- Conservation of Energy

### i) The steps taken on conservation of energy.

- a. During the year, Energy Audit were carried out at Aditya, Belagavi, Hirakud, Renukoot, Muri & Dahej unit, Energy saving opportunities identified and projects initiated.
- b. A two-day virtual training session was conducted covering various topic on Energy Conservation which was attended by a large group of Hindalco employees.
- c. During the year, Utkal unit was certified ISO 50001. With this, total six units are now ISO 50001 certified.
- d. Reduction in Aluminium Smelter energy consumption through phased implementation of copper insert collector bar, Cast iron sealing, Step stub Anode, etc. During the year, total 319 pots were modified with copper insert collector bar at Aditya, Mahan & Hirakud Smelters.
- e. Project on current efficiency improvement and Pot life prediction at Mahan & Aditya Smelter has been taken up through application of Digital twin.
- f. Power Plant efficiency improvement by improving Condenser Vacuum through improvised tube cleaning, TG overhauling, duct modification through CFD study etc.
- g. Reduction in Power Plant auxiliary power consumption through various energy conservation initiatives like de-staging Boiler Feed Pump, Cooling Tower fan blade modification, booster pump application, process optimisation etc.
- h. Replacement of conventional motors with energy efficient motors.
- i. Installation of motion sensors and Lux level sensors in office buildings and shopfloor for lighting power conservation.
- j. Replacement of conventional light with LED in phased manner.
- k. Reduction in energy consumption of furnace through Condition Monitoring (Thermography) and process optimisation.

- l. Rationalization of motor, pump & fan capacity and replacement of inefficient pumps & motors with high efficiency pumps & motors.
- m. Energy efficient & corrosion resistant coating in pumps.
- n. Installation of VFD in variable load application.
- o. Compressed Air system efficiency improvement through replacement of inefficient compressors, arresting leakages, process optimization etc.

### ii) The steps taken by the company for utilising alternate sources of energy.

- a. Additional 50 MW Solar PV capacity was added during year with installations at five locations v.i.z Mahan, Mouda, Talaja, Renukoot & Renusagar. With this total 100 MW renewable installed capacity is reached.
- b. Renewable Hybrid (20 MW Solar + 20 MW Wind) Project is finalized for Dahej and contract awarded. Target commission date is March'23.
- c. Contract for 5 MW Wind Power for Talaja unit has been finalized. Power flow expected from Jul'22.
- d. Additional 50 MW of renewable project including renewable hybrid is under finalization at various locations.
- e. The company is actively pursuing a Renewable Hybrid with pumped hydro storage project for 100 – 300 MW of RTC power for Aditya unit. Upgradation of Grid connectivity from 220 KV to 400 KV is also taken up at this unit to improve reliability.
- f. The company is also exploring large scale Floating Solar project.
- g. 25 Nos of Solar street light at Dahej unit.

### iii) The capital investment on energy conservation equipment

The Capital investment on Energy conservation equipment & projects for the year was INR 277 crore.



## Annexure II

### B - Technology Absorption

#### (a) The following efforts made towards technology absorption at Mahan

- Successful insertion of 53 copper Insert collector bar Pots in Potline in FY22 resulting in better Energy efficiency.
- 220kV Bus Sectionalizer Project completed in CPP.
- Black Start DG Governor & SCADA system Upgraded.
- Installation of water mist suppression system at reject paste belt conveyor to enhance fire safety at Green Anode Plant.
- Installation of high-capacity axial piston pump in place of internal gear pump at hydraulic unit to enhance reliability at GAP.
- Customization of machine to trim elongated pins on stem assembly itself, to eliminate cutting/removal and re-welding of pins.
- Use of Ultra Capacitor in place of Battery Bank in Fire Hydrant Engines.
- Ultrasonic testing using specialized equipment (UE-15000) for predictive/preventive & breakdown analysis of Bearings, Electrical testing (Motors, Greasing, Cables, feeders, transformer, TG etc.) & gas leakages implemented .
- Online CBM surveillance system development for Wire rod mill finishing mill motor with dashboard.
- In-house method developed for measurement of Baked anode Electrical Resistivity.
- Digitization of Ladle management system and Cast ID generation for improving Quality management.
- Digitized Auto Dia selection of Billet casting table for eliminating wrong table dia selection issues.
- Algorithm development for predictive analysis of furnace tilting position and protection of furnace tilting cylinder from over stroking in cast house.
- Indigenous PLC Simulator for testing & people development done in Cast house .
- Indigenous First-time testing facility developed for Electric Gloves Testing Machine (40 KV/160mA)

- Wire rod mill Casting wheel temperature monitoring system (Battery operated) has been developed. Low-cost solution developed.
- Indigenous development of Controller for Co2 and Air Analyzer.
- Indigenous development of probe for Billet Ultrasonic system.
- Fire detection AI camera installation in GAP.
- Online real-time Diagnostic system installation in CRS primary crusher.
- Asset management system for reliability improvement and backup in PLC program.
- In house development of ground leakage detector for safety improvement in HFO area.
- RFID system installation in ARS.
- Realtime position monitoring of ARS casting machine tilting function for safety and reliability improvement.
- Soft starter-based bypass panel installed in CRS primary crusher for risk mitigation.
- Mitigation of frequent HUH VFD failure by upgradation. 2 VFD failure per year to Zero failure and reliability improvement by vendor substitution from Rexroth to Parker in GAP proportional valves.
- Digitalization of Real-time oil Condition Monitoring system , CMS for turbines and Motors ,Wear ,tear and Deformation monitoring system for P&F driven chain has been made .
- Mechanical coal sampling system Augur installed.
- Coal supply chain tracking system through inhouse IT Team.
- Drone survey of Coal stock yard for accurate inventory management.
- Auto synchronization project completed for all units of CPP
- Fast Bus transfer scheme for ST-1 & ST-2 of CPP.
- Bluetooth based current clamp meter for remote measurement.

#### (b) Specific Areas in which R&D has been carried out at Belagavi HIC:

- Development of specialty hydrates for EN45545/HL polymeric composites of railways.
- Renukoot liquor Productivity increased from 73 g/L to 78 g/L based on process optimization measures.
- Development of Green cold Tamping Paste for Pot relining in Renukoot & Hirakud Smelters.
- Development of Low Soda Submicron Reactive Alumina for Advanced Ceramics application.
- Development of Medium Calcined Fine Alumina for Brake Lining Application for US customers.
- Development of hard calcined low soda alumina for Vacuum circuit breaker.
- Conducted lab trials with all sources of bauxite and devised a model for efficient processing at plant.
- Development and simulation of lab scale process for producing hydrate with <50 ppm Fe2O3 in the hydrate.

#### The developmental works implemented at Renukoot :

- Sigma scope SMP350 conductivity meter for electrical conductivity measurement
- Installed Carbon, Hydrogen & Sulphur Analyser for Solid Samples.
- Installed TGA-ELTRA which is used for the analysis of Coal and Coke.
- Installed Gas Chromatography for determination of additives and carbon chain in oil used in fabrication coolant.
- Installed Electrical Resistivity Analyzer which is used to determine the electrical resistivity in baked anode samples.
- Installed Air reactivity Analyzer for determining the air reactivity in baked anode & CP coke samples.

#### Efforts made towards technology absorption at Aditya Smelter:

- Successful insertion of 110 copper Insert collector bar Pots in Potline in FY22 resulting in better Energy efficiency.
- 3no's of BFP de-staged in FY-22 with energy saving of 200kW/pump.

- 7no's of Cooling tower fan blade replaced with FRP blades.
- Improvement in ash handling plant specific power consumption by optimized running of Compressors.
- Tube settler for coal recovery and water clarification done.
- Modification done in coal mills by increasing the pulverizing capacity and thereby reducing the mill rejects.
- Secured NABL accreditation for oil testing lab.
- Power Plant simulator has been installed for providing hands on experience to the desk engineers.
- Completed the Track hopper project, enabling to handle coal through both BOBRN and BOXN wagons.

#### Technology absorption efforts at UTKAL:

- New upgraded flocculant (HX-6300S) introduced in High-Rate decanter (HRD) in place of existing *CYTECH HX-600* flocculant. Plant trial was successfully conducted in the HRD after set of laboratory trials.
- Liquor productivity 91 gpl is achieved through process control optimization.
- Inhouse, Complex process logic and control loop developed for Mud and wash water management to optimize soda loss across washers.
- Machine learning software "Mtell" for Critical equipment health monitoring.
- Aerobin Composter installed for food waste with 400 liters capacity.

#### Technical Absorption efforts in Downstream plants:

- Upgradation of Old SMS Wedge scale system (Binary input type) to Temposonic type scale with analog input function.
- Upgradation of SMS Xray gauge system from Thermofisher make to IMS make due to technology Obsolescence and achieving measurement with % deviation within 0.05%
- Upgradation of SMS IO module from S100 to S800 of ABB PLC system.
- Up-gradation of SMS mill Schleifring unit STU (Signal Transmission unit) PFSA 103D with air humidifier unit.

## Annexure II

- Entry coil car motor and drive upgradation from AC to DC system at SMS mill
- Isothermal Extrusion System (IES) at extrusion Press no.7
- PODFA instrument installation at Cast House for measuring inclusion level in metal.
- Alscan analyser (Ar gas based) for H, -gas analysis in liquid metal
- Therelek Lab Oven Furnace in Renukoot Extrusion for lab trials of heat treatment cycles.

### Technology Absorption efforts at Mines :

- Drone technology for surveying and volume estimation, Geo-fencing in truck transport, weighbridge automation, digital ore tracking, best in class quality lab at mines location, mine planning software.

### The benefits derived like product improvement, cost reduction, product development or import substitution

### Benefits derived as a result of technology absorption at Mahan

- **New Product development**
  - o New alloy 6063L in Billet Casting with modified homogenizing cycle for enhanced extrudability.
  - o High purity P33HP Sows production.
  - o New alloy "Diuranium" & 6082V developed in Billet.
- **New process development:**
  - o Developed new process for achieving High conductivity Wire rod through Boron addition in furnaces.
  - o Developed new process for achieving products with low Ti and V in Sow Casting machine.
- **Productivity improvement:**
  - o Replaced 32 NB soft water supply pipeline with 80 NB. This will reduce WRM bimonthly shutdown duration by 3 Hrs.
  - o Pot productivity increase from 2.762 t/pot/day to 2.801 t/pot/day by increasing/ ramping up current from 367 KA to 371 KA.

- **Quality improvement:**
  - o Modification and in house fabrication of Tibor rod frame for reliable and consistency in Tibor rod feed rate in Wire rod.
- **Safety Enhancement:**
  - o Replacement of OXY -DA cutting by Plasma cutting.
  - o Aerosol Based Smoke detector testing implemented as a standard practice to check and maintenance of Smoke detector, eliminating use of incense sticks.
  - o 6.6 KV switchboard breaker - remote racking.
- **Energy Efficiency :**
  - o Current Efficiency increase and Energy per MT of the Hot metal to the tune of 250 KWhr /MT due to gradual change over to copper insert Pots in Smelter.
- **Import Substitution**
  - o Hydraulic oil in ICM Furnaces power pack from M/S Quaker France to M/S IOCL India.
  - o Wire rod finishing mill gear oil changed from MOBIL-XP 220 to SERVO XP-220.
  - o Carbon plant - Cutting and reuse of old, elongated pins to reduce new pin consumption in stem repair shop.
  - o Carbon plant Use of servo cut oil in place of Valona oil for mould spraying system.
  - o carbon plant - Indigenization of Vibro compactor mould.

### Benefits realised as part of developmental work at Renukoot:

- Upgradation of lab infrastructure for better control in raw materials and in process quality.

### Benefits realised due to the technology absorption at Aditya:

- Increase in current efficiency and reduction in the Specific energy consumption due to the copper insert collector bar pots.
- Lowest ever Auxiliary power consumption of 7.18% achieved in FY-22.
- Improvement in turbine heat rate by 6 Kcal/KWH due to installation of new design multistage BD valve in 2 units.

- Flexibility in coal handling through BOXN and BOBRN rakes.
- Reduction in Coal rake unloading Turnaround time.

### Benefits due to technology absorption efforts at UTKAL:

- Upgraded flocculants results in better process control and efficiency.
- Improved equipment reliability due to digital initiatives.
- Improved energy efficiency and liquor productivity at alumina refinery.

### Benefits realised due to technological Efforts at Belagavi:

- Improvement of plant process efficiency and consistency in the quality of Bayer hydrate.
- Increase in sales realization in the value-added products, leading to the improvement in business profitability.
- Increase in market share in preferred applications and entering new market segments.

- Development of environmentally friendly products, leading to a more sustainable business.

### Benefits realised due to technological Efforts at Downstream:

- Development of Can Body Stock (CBS), qualification of product at Can Manufacturer and commercial production from HKD FRP.
- 5083 H321 (Special Temper) plates developed in house for Railway wagon, Bulker and Trailer application by stabilizing low temperature Hot Rolling.
- Semi-Rigid Container (SRC) stock developed in-house which is better than Chinese imports, in terms of product performance.

### Benefits realised due to technological Efforts at Mines :

- Overall accuracy in estimation of volumes, Overall mineral quality improvement, and fast response time with the customers.

### In case of imported technology (imported during the last three years reckoned from the beginning of the financial year)

Technology imported for	Year of import	Has technology been fully absorbed	If not fully absorbed areas where this has not taken place reason thereof and future plan of action
At Mahan Aluminium NOx project - M/S FORTUM Finland (completed in CPP Unit # 3)	2021	Yes completed	
At Mahan SPM control system-HFTR and Micro pulse project in ESP Transformer completed in all units. M/s Helios & Kraft Powercon	2022	Yes completed	
Integrated Mine Planning software	2022	No	Under implementation

### R&D expenses Incurred :

The Company has spent ₹ 31 crore for Research and Development during the Financial Year 2021-2022.

### Foreign Exchange earnings & Out Go.

- Activities related to exports. Exports (FOB) during the year were ₹ 21,416 crore.
- Total Foreign Exchange used and earned.
  - Foreign Exchange used ₹ 37,494 crore.
  - Foreign Exchange Earned ₹ 21,416 crore.



## Annexure III

Details pertaining to remuneration as required under Section 197(12) of the Companies Act, 2013 read with Rule 5(1) of the Companies (Appointment and Remuneration of Managerial Personnel) Rules, 2014

- i. The percentage increase in remuneration of each Director, Chief Financial Officer and Company Secretary during the Financial year 2021-22, ratio of the remuneration of each Director to the median remuneration of the employees of the Company for the Financial year 2021-22 are as under:

Sr. No.	Name of Director/ KMP and Designation	Remuneration* of Director/ KMP for Financial Year 2021-22 (₹ in Lakhs)	% increase in Remuneration in the Financial Year 2021-22	Ratio of remuneration of each Director/to median remuneration of employees
1	Kumar Mangalam Birla	–	Not applicable	–
2	Rajashree Birla	348.01	16.72%	52.97
3	A.K.Agarwala	37.97	11.87%	5.78
4	Vikas Balia	54.40	15.06%	8.28
5	Y.P. Dandiwala	57.75	14.93%	8.79
6	K.N. Bhandari	61.42	13.87%	9.35
7	Alka Bharucha	36.61	5.14%	5.57
9	D. Bhattacharya^ ***	34.62	13.29%	5.27
10	Sudhir Mital	37.61	35.19%	5.72
11	Anant Maheshwari	31.61	69.40%	4.81
12	Satish Pai	4652.47	88.88%	708.14
13	Praveen Kumar Maheshwari	639.67	68.89%	97.36
14	Anil Malik	164.00	31.98%	24.96

^ Additionally, at the time of retirement, Board had approved pension of ₹ 0.335 crore per month, for his past service when he was the Managing Director of the Company. The present value of the above pension liability determined based on the actuarial valuation is accounted by the Company in its financial statements. Amount charged as expenses in the statement of profit and loss during the year amounting to ₹ 3 crores has been disclosed as a part of managerial remuneration.

\*\*\* Mr. D. Bhattacharya ( DIN: 00033553) has resigned as Director w.e.f 02nd March, 2022.

- i The median remuneration of employees of the Company during the financial year was ₹ 6.57 Lacs  
 ii In the financial year, there was an increase of 2.50% in the median remuneration of employees  
 iii There were 21,151 permanent employees on the rolls of Company as on 31st March, 2022  
 iv Average percentage increase made in the salaries of employees other than the managerial personnel in the last financial year i.e. 2021-22 was 2.5 % whereas the increase in the managerial remuneration for the same financial year was 86.21%. For the purpose of managerial personnel, Managing Director and Whole time Director are considered.  
 v It is hereby affirmed that the remuneration paid is as per the Remuneration Philosophy / Policy of the Company.  
 vi Remuneration excludes amortization of fair value of employee share based payments under Ind As 102 and provision for gratuity and leave encashment recognised on the basis of actuarial valuation as separate figures are not available.  
 vii In terms of ESOS-2018, 10,29,304 Stock Options have vested in Mr. Satish Pai during the year.  
 viii In terms of ESOS-2018, 87,566 Stock Options have vested in Mr. Praveen Kumar Maheshwari during the year.

For and on behalf of the Board

**Satish Pai**  
 Managing Director  
 DIN:06646758

**K.N. Bhandari**  
 Independent Director  
 DIN: 00026078

Place : Mumbai  
 Dated : 22nd July, 2022

## Annexure IV

Hindalco Industries Limited ("the Company") an Aditya Birla Group Company adopts/shall adopt this Executive Remuneration Philosophy/Policy as applicable across Group Companies. This philosophy/ policy is detailed below.

### Aditya Birla Group: Executive Remuneration Philosophy/Policy

At the Aditya Birla Group, we expect our executive team to foster a culture of growth and entrepreneurial risk-taking. Our Executive Remuneration Philosophy/Policy supports the design of programs that align executive rewards – including incentive programs, retirement benefit programs, promotion and advancement opportunities – with the long-term success of our stakeholders.

#### Our business and organizational model

Our Group is a conglomerate and organized in a manner such that there is sharing of resources and infrastructure. This results in uniformity of business processes and systems thereby promoting synergies and exemplary customer experiences.

- I. Objectives of the Executive Remuneration Program  
 Our executive remuneration program is designed to attract, retain, and reward talented executives who will contribute to our long-term success and thereby build value for our shareholders.

Our executive remuneration program is intended to:

1. Provide for monetary and non-monetary remuneration elements to our executives on a holistic basis
2. Emphasize "Pay for Performance" by aligning incentives with business strategies to reward executives who achieve or exceed Group, business and individual goals.

#### II. Covered Executives

Our Executive Remuneration Philosophy/Policy applies to the following:

1. Directors of the Company
2. Key Managerial Personnel: Chief Executive Officer and equivalent (eg: Deputy Managing Director), Chief Financial Officer and Company Secretary.
3. Senior Management : As decided by the Board

#### III. Business and Talent Competitors

We benchmark our executive pay practices and levels against peer companies in similar industries, geographies and of similar size. In addition, we look at secondary reference (internal and external) benchmarks in order to ensure that pay policies and levels across the Group are broadly equitable and support the Group's global mobility objectives for executive talent. Secondary reference points

bring to the table, the executive pay practices and pay levels in other markets and industries, to appreciate the differences in levels and medium of pay and build in as appropriate for decision making.

#### IV. Executive Pay Positioning

We aim to provide competitive remuneration opportunities to our executives by positioning target total remuneration (including perks and benefits, annual incentive pay-outs, long term incentive pay-outs at target performance) and target total cash compensation (including annual incentive pay-outs) at target performance directionally between median and top quartile of the primary talent market. We recognize the size and scope of the role and the market standing, skills and experience of incumbents while positioning our executives.

We use secondary market data only as a reference point for determining the types and amount of remuneration while principally believing that target total remuneration packages should reflect the typical cost of comparable executive talent available in the sector.

#### V. Executive Pay-Mix

Our executive pay-mix aims to strike the appropriate balance between key components: (i) Fixed Cash compensation (Basic Salary + Allowances) (ii) Annual Incentive Plan (iii) Long-Term Incentives (iv) Perks and Benefits

##### Annual Incentive Plan:

We tie annual incentive plan pay-outs of our executives to relevant financial and operational metrics achievement and their individual performance. We annually align the financial and operational metrics with priorities/ focus areas for the business.

##### Long-Term Incentive:

Our Long-term incentive plans incentivize stretch performance, link executive remuneration to sustained long term growth and act as a retention and reward tool.

We use stock options as the primary long-term incentive vehicles for our executives as we believe that they best align executive incentives with stockholder interests.

We grant restricted stock units as a secondary long term incentive vehicles, to motivate and retain our executives.

#### VI. Performance Goal Setting

We aim to ensure that for both annual incentive plans and long term incentive plans, the target performance goals shall be achievable and realistic.

## Annexure IV

Threshold performance (the point at which incentive plans are paid out at their minimum, but non-zero, level) shall reflect a base-line level of performance, reflecting an estimated 90% probability of achievement.

Target performance is the expected level of performance at the beginning of the performance cycle, taking into account all known relevant facts likely to impact measured performance.

Maximum performance (the point at which the maximum plan payout is made) shall be based on an exceptional level of achievement, reflecting no more than an estimated 10% probability of achievement.

### VII. Executive Benefits and Perquisites

Our executives are eligible to participate in our broad-based retirement, health and welfare, and other employee benefit plans. In addition to these broad-based plans, they are eligible for perquisites and benefits plans commensurate with their roles. These benefits are designed to encourage long-term careers with the Group.

#### Other Remuneration Elements

Each of our executives is subject to an employment agreement. Each such agreement generally provides for a total remuneration package for our executives including continuity of service across the Group Companies.

We limit other remuneration elements, for e.g. Change in Control (CIC) agreements, severance agreements, to instances of compelling business need or competitive rationale and generally do not provide for any tax gross-ups for our executives.

#### Risk and Compliance

We aim to ensure that the Group's remuneration programs do not encourage excessive risk taking. We review our remuneration programs for factors such as, remuneration mix overly weighted towards annual incentives, uncapped pay-outs, unreasonable goals or thresholds, steep pay-out cliffs at certain performance levels that may encourage short-term decisions to meet pay-out thresholds.

#### Claw back Clause:

In an incident of restatement of financial statements, due to fraud or non-compliance with any requirement of the Companies Act 2013 and the rules made thereafter, we shall recover from our executives, the remuneration received in excess, of what would be payable to him / her as per restatement of financial statements, pertaining to the relevant performance year.

#### Implementation

The Group and Business Centre of Expertise teams will assist the Nomination & Remuneration Committee in adopting, interpreting and implementing the Executive Remuneration Philosophy/Policy. These services will be established through "arm's length", agreements entered into as needs arise in the normal course of business.

## Annexure VA

### Form No. MR-3 SECRETARIAL AUDIT REPORT

#### FOR THE FINANCIAL YEAR ENDED 31<sup>ST</sup> MARCH 2022

[Pursuant to Section 204 (1) of the Companies Act, 2013 and Rule no. 9 of the Companies (Appointment and Remuneration of Managerial Personnel) Rules, 2014]

#### To

#### The Members

#### Hindalco Industries Limited

Ahura Centre, 1st Floor,  
B Wing Mahakali Caves Road,  
Mumbai - 400093

We have conducted the Secretarial Audit of the compliance of applicable statutory provisions and the adherence to good corporate practices by **HINDALCO INDUSTRIES LIMITED** having CIN No. L27020MH1958PLC011238 (hereinafter called the 'Company') for the audit period covering the financial year ended on **31<sup>st</sup> March 2022** (the 'audit period'). Secretarial Audit was conducted in a manner that provided us a reasonable basis for evaluating the corporate conducts/statutory compliances and expressing our opinion thereon.

Based on our verification of the Company's books, papers, minute books, forms and returns filed, soft copy as provided by the company and other records maintained by the Company and also the information provided by the Company, its officers, agents and authorized representatives during the conduct of Secretarial Audit; We hereby report that in our opinion, the Company has, during the audit period complied with the statutory provisions listed hereunder and also that the Company has proper Board-processes and compliance-mechanism in place to the extent, in the manner and subject to the reporting made hereinafter.

We have examined the books, papers, minute books, forms and returns filed and other records maintained by the Company for the financial year ended on 31st March, 2022 according to the provisions of:

- (i) The Companies Act, 2013 (the 'Act') and the Rules made thereunder;
- (ii) The Securities Contracts (Regulation) Act, 1956 and the Rules made thereunder;
- (iii) The Depositories Act, 1996 and the Regulations and Bye-laws framed thereunder;
- (iv) Foreign Exchange Management Act, 1999 and the Rules and Regulations made thereunder to the extent of Overseas Direct Investment and External Commercial Borrowings.
- (v) The following Regulations and Guidelines prescribed under the Securities and Exchange Board of India Act, 1992;

- (a) The Securities and Exchange Board of India (Substantial Acquisition of Shares and Takeovers) Regulations, 2011;
- (b) The Securities and Exchange Board of India (Prohibition of Insider Trading) Regulations, 2015;
- (c) The Securities and Exchange Board of India (Share Based Employee Benefits and Sweat Equity) Regulations, 2021)
- (d) The Securities and Exchange Board of India (Registrars to an Issue and Share Transfer Agents) Regulations, 1993; and
- (e) The Securities and Exchange Board of India (Listing Obligations and Disclosure Requirements) Regulations, 2015;
- (f) The Securities and Exchange Board of India (Issue and Listing of Non Convertible Securities ) Regulations, 2021.
- (vi) Other laws specifically applicable to the Company are:
  - (a) The Mines Act, 1952; and
  - (b) The Mines and Minerals (Regulation and Development) Act, 1957.

We have also examined compliance with the applicable clauses of the Secretarial Standards issued by the Institute of Company Secretaries of India during the audit period;

During the audit period, the Company has complied with the provisions of the Acts, Rules, Regulations and Bye-laws mentioned above.

During the period under review, provisions of the following regulations were not applicable to the Company:

- (i) The Securities and Exchange Board of India (Delisting of Equity Shares) Regulations, 2009;
- (ii) The Securities and Exchange Board of India (Buyback of Securities) Regulations, 1998; and
- (iii) The Securities and Exchange Board of India (Issue of Capital and Disclosure Requirements) Regulations, 2009;
- (iv) The Foreign Exchange Management Act, 1999 and the Rules and Regulations made thereunder to the extent of Foreign Direct Investment.



## Annexure VA

### We further report that –

The Board of Directors of the Company is duly constituted with proper balance of Executive Directors, Non-Executive Directors and Independent Directors as on 31<sup>st</sup> March 2022 as under:

- I. Two Executive Directors i.e. Mr. Satish Pai and Mr. Praveen Kumar Maheshwari;
- II. Three Non- Executive Non- Independent Directors i.e. Mr. Kumar Mangalam Birla chairperson, Mrs. Rajashree Birla and Mr. A K Agarwala, ; and
- III. Six Non-Executive Independent Directors, including one woman director i.e. Mrs. Alka Bharucha, Mr. K.N. Bhandari, Mr. Y.P. Dandiwala, Mr. Vikas Balia, Mr. Sudhir Mital and Mr. Anant Maheshwari.

During the year the following changes in the composition of the Board of Directors were carried out in compliance with the provisions of the Act, Rules made thereunder and SEBI (LODR) Regulations:

- I. Re- appointment of Mr. A. K. Agarwala (DIN: 00023684), as a Director, Retired by Rotation and re- appointed in the 62<sup>nd</sup> Annual General Meeting held on 23<sup>rd</sup> August, 2021
- II. Resignation of Mr. D. Bhattacharya, as a Non-Executive - Non Independent Director w.e.f. 02<sup>nd</sup> March 2022.

Adequate notice is given to all directors to schedule the Board Meetings, agenda and detailed notes on agenda were sent at least 7 (seven) days in advance except for two Board Meetings where consent for shorter notice was obtained from majority of the directors. System exists for seeking and obtaining further information and clarifications on the agenda items before the meeting and for meaningful participation at the meeting.

Decisions at the meetings of the Board of Directors of the Company were carried through on the basis of majority. There were no dissenting views by any member of the Board of Directors during the audit period.

**We further report that** there are adequate systems and processes in the Company commensurate with the size and operations of the Company to monitor and ensure compliance with applicable laws, rules, regulations and guidelines.

**We further report that** during the audit period, following specific event / action has occurred during the year:

1. During the audit period, the Company has allotted its equity shares under Employee Stock Option Schemes, as follows:

- i. First Quarter from 1<sup>st</sup> April, 2021 to 30<sup>th</sup> June, 2021 – 2,16,362 equity shares of ₹ 1 each.
- ii. Second Quarter from 1<sup>st</sup> July, 2021 to 30<sup>th</sup> September, 2021 – 2,14,126 equity shares of ₹ 1/- each.
- iii. Third Quarter from 1<sup>st</sup> October, 2021 to 31<sup>st</sup> December, 2021 – 7,475 equity shares of ₹ 1/- each.
- iv. Fourth Quarter from 1<sup>st</sup> January, 2022 to 31<sup>st</sup> March, 2022 – 2,884 equity shares of ₹ 1/- each.

2. The Board of the Directors in its Board Meeting dated 06<sup>th</sup> August, 2021, authorize the company to invest an amount not exceeding ₹ 2,50,00,000/- (Rupees Two Crore fifty lakhs only) for formation of the Legal entity i.e., Kabushiki Kaisha (KK) i.e., a Joint-Stock Company in Japan subject to approvals from RBI.
3. The Board of the Directors in its Board Meeting dated 20<sup>th</sup> January 2022, authorize the company to acquire the extrusion business of Sapa Extrusion India Private Limited located by the Company on a slump sale basis as a going concern (as defined under Section 2(42c) of the Income Tax Act, 1961) for an aggregate calculation of ₹ 2,47,00,00,000/- (Indian Rupees Two Hundred and Forty Seven Crores Only) (subject to certain adjustments agreed between the Parties) ("Agreed Consideration"), as per the terms and conditions provided in the mutually agreed Business Transfer Agreement dated 17<sup>th</sup> December, 2021.
4. The Board of the Directors in its Board Meeting dated 20<sup>th</sup> January 2022, approved the disinvest 100% equity stake from the Company's first-level step down wholly owned subsidiary i.e. "Hindalco do Brasil Indústria e Comércio de Alumina Ltda." (held through A V Minerals N.V., Netherlands) (herein referred to as "HDB") by accepting the offer made by the Brazilian firm "Terrabel Empreedimentos Ltd" and / or any other "buyer" as per the terms and conditions mutually agreed upon by the Company and the said buyer and / or any other prospective buyer(s) in the best interest of the Company.

**For BNP & Associates  
Company Secretaries  
[Firm Regn. No. P2014MH037400]  
PR. No: 637/2019**

**Place: Mumbai  
Date: 26<sup>th</sup> May 2022**

**B. Narasimhan  
FCS : 1303  
ACS : 10440  
UDIN: F001303D000363522**

**Note: This report is to be read with our letter of even date which is annexed as Annexure A and forms an integral part of this report.**

### Annexure A

**To,  
The Members,  
Hindalco Industries Limited**

Secretarial Audit Report of even date is to be read along with this letter.

1. The compliance of provisions of all laws, rules, regulations, standards applicable to Hindalco Industries Limited (the 'Company') is the responsibility of the management of the Company. Our examination was limited to the verification of records and procedures on test check basis for the purpose of issue of the Secretarial Audit Report.
2. Maintenance of secretarial and other records of applicable laws is the responsibility of the management of the Company. Our responsibility is to issue Secretarial Audit Report, based on the audit of the relevant records maintained and furnished to us by the Company, along with explanations where so required.
3. We have followed the audit practices and processes as were appropriate to obtain reasonable assurance about the correctness of the contents of the secretarial and other legal records, legal compliance mechanism and corporate conduct. The verification was done on test check basis to ensure that correct facts as reflected in secretarial and other records produced to us. We believe

that the processes and practices we followed, provides a reasonable basis for our opinion for the purpose of issue of the Secretarial Audit Report.

4. We have not verified the correctness and appropriateness of financial records and Books of Accounts of the Company.
5. Wherever required, we have obtained the management representation about the compliance of laws, rules and regulations and major events during the audit period.
6. The Secretarial Audit Report is neither an assurance as to the future viability of the Company nor of the efficacy or effectiveness with which the management has conducted the affairs of the Company.

**For BNP & Associates  
Company Secretaries  
[Firm Regn. No. P2014MH037400]  
PR. No: 637/2019**

**B. Narasimhan  
FCS : 1303  
ACS : 10440  
UDIN: F001303D000363522**  
**Place: Mumbai  
Date: 26<sup>th</sup> May 2022**

# Annexure VB

FORM NO. - MR-3

## SECRETARIAL AUDIT REPORT

For the financial year ended 31<sup>st</sup> March 2022

[Pursuant to section 204(1) of the Companies Act, 2013 and Rule No.9 of the Companies (Appointment and Remuneration of Managerial Personnel) Rules, 2014]

To,  
The Members  
Utkal Alumina International Limited  
J 6 Jayadev Vihar Bhubaneswar 751013

We have conducted the Secretarial Audit of the compliance of applicable statutory provisions and the adherence to good corporate practices by **Utkal Alumina International Limited CIN No. U13203OR1993PLC003416** (hereinafter called the 'Company') for the audit period covering the financial year ended on **31<sup>st</sup> March 2022** (the 'audit period').

We have conducted the Secretarial Review in a manner that provided us with a reasonable basis for evaluating the Company's corporate conducts / statutory compliances and for expressing our opinion thereon.

We are issuing this report based on:

- (i) Our **verification** of the Company's books, papers, minutes books, soft copies of various records, scanned copies of minutes of meetings of the Board, its committees, forms and returns filed and other records maintained by the Company, provided to us through electronic mode;
- (ii) **representations** made, documents shown and information provided by the Company, its officers, agents and authorized representatives during our conduct of Secretarial Audit of the Company

We hereby report that, in our opinion, during the Audit Period covering the financial year ended on 31<sup>st</sup> March 2022, the Company has: -

- (i) Complied with the statutory provisions listed hereunder; and
- (ii) Board processes and compliance mechanism are in place to the extent, in the manner and subject to the reporting made hereinafter.

The members are requested to read this report along with our letter of even date annexed to this report as Annexure-A.

### 1. Compliance with specific statutory provisions

We further report that:

- 1.1 We have examined the books, papers, minutes books, forms and returns filed and other records maintained by the Company during the year in terms of the applicable provisions / clauses of:
  - (i) The Companies Act, 2013 (the Act) and the Rules made thereunder;
  - (ii) The Depositories Act, 1996 and the Regulations and Bye-laws framed thereunder;

- (iii) Secretarial Standards (SS-1 and SS-2) issued by the Institute of Company Secretaries of India respectively relating to meetings of the Board and its Committees and general meetings of the Company which have mandatory application to the Company.
- (iv) The Securities Contracts (Regulation) Act, 1956 and the Rules made thereunder
- (v) Foreign Exchange Management Act (FEMA), 1999 and the Rules and Regulations made thereunder to the extent of Overseas Direct Investments and External Commercial Borrowings

1.2 During the period under review, the Company has, to the best of our knowledge and belief and based on the records, information, explanations and representations furnished to us:

- (i) Complied with the provisions of the Act, Rules, Regulations, Guidelines and Secretarial Standards as mentioned above.
- (ii) Generally complied with the applicable provisions / clauses of:
  - (a) The Act and Rules mentioned under paragraph 1.1 (i) and
  - (b) The Secretarial Standard on meetings of the Board of Directors (SS-1) and Secretarial Standard on General Meetings (SS-2) mentioned under paragraph 1.1 (vi) above to which are applicable to meetings of Board of Directors and Committees constituted by the Board held during the year, the 28<sup>th</sup> Annual General Meeting of the members held 30<sup>th</sup> November 2021 The compliance of the provisions of the Rules made under the Act with regard to participation of Directors through video conference for the Board/Committee meeting(s) held during the year, were verified based on the minutes of the meetings provided by the Company.

1.3 There are no other laws that were specifically applicable to the Company during the period under review, considering the nature of its business.

During the period under review, provisions of the following Regulations were not applicable to the Company:

- (a) SEBI (Substantial Acquisition of Shares and Takeovers) Regulations, 2011;
- (b) SEBI (Issue of Capital and Disclosure Requirements) Regulations, 2018;

- (c) SEBI (Share Based Employee Benefits and Sweat Equity) Regulations, 2021;
- (d) SEBI (Delisting of Equity Shares) Regulations, 2009;
- (e) SEBI (Buyback of Securities) Regulations, 2018;
- (f) SEBI (Listing Obligations and Disclosure Requirements) Regulations, 2015
- (g) SEBI (Prohibition of Insider Trading) Regulations, 2015;
- (h) SEBI (Registrars to an Issue and Share Transfer Agents) Regulations, 1993 regarding the Companies Act and dealing with client; and
- (i) The Foreign Exchange Management Act, 1999 and the Rules and Regulations made thereunder.

### 2. Board Process

**We further report that -**

The Board of Directors of the Company as on 31<sup>st</sup> March 2022, comprised of:

- (i) Six Non-Executive Non-Independent Directors that are Mr Praveen Kumar Maheshwari, Mr. Indrajit Pathak, Ms Pragnya Ram, Mr Surya Kanta Mishra, Mr Anil Vasant Arya, Mr Rajesh Kumar Gupta
- 2.2 The processes relating to the following changes in the composition of the Board of Directors and Key Managerial Personnel during the year were carried out in compliance with the provisions of the Act:
  - (i) Re-appointment of Ms. Pragnya Ram as a Director (DIN: 02544268) who retired by rotation at 28<sup>th</sup> Annual General Meeting held on 30<sup>th</sup> November 2021.
- 2.3 Adequate notices have been given to all the directors of the Company to enable them to plan their schedules for the Board meeting(s), except in respect of a few meetings which were convened at a shorter notice for which necessary consent was received, which were compliant with the provisions of the Act as prescribed.
- 2.4 Notice for the Board meetings has been given to all the directors at least seven days in advance except in respect of a for the few meetings convened at a shorter notice, at which more than one Independent Director was present as required under Section 173 (3) of the Act and SS-1.
- 2.5 Agenda and detailed notes on agenda circulated to all the directors at least seven days before the Board meetings, except for few meetings which were convened at a shorter notice.
- 2.6 A system exists for directors to seek and obtain further information and clarifications on the agenda items before the meetings and to ensure their meaningful participation at the meetings.
- 2.7 We note from the minutes examined that, at the Board meetings held during the year:

- (i) Decisions were taken through the majority of the Board; and
- (ii) No dissenting views were expressed by any Board member on any of the subject matters discussed, which were required to be recorded as part of the minutes.

### 3. Compliance Mechanism

**We further report that** there are reasonably adequate systems and processes in the Company, commensurate with its size and operations, to monitor and ensure compliance with applicable laws, rules, regulations and guidelines.

### 4. Specific events / actions

**We further report that** during the audit period under review, as explained and represented by the management, there were no specific events/actions in pursuance of the above referred laws, rules, regulations, guidelines, standards etc., which have a major bearing on the Company's affairs except for the following:

- Pursuant to an agreement between the Company and Orissa Mining Corporation Limited ('OMCL'), the Company has agreed to issue 15% Fully Convertible Cumulative Preference Shares amounting to Rs. 20 crores with face value of ₹ 10 each, at par in consideration for transfer of license, mining leases and all rights thereto, rendering of related technical services etc. by OMCL. The Company has decided to issue Unsecured, Redeemable Non-Convertible Debentures in lieu of the Preference shares to OMCL. In terms of Debenture Subscription Agreement entered into between the Company and OMCL, the Board of Directors of the Company has passed a resolution at its meeting held on September 21<sup>st</sup>, 2021 approving the issuance of one zero coupon Unsecured Redeemable Non-Convertible Debentures of ₹ 3 Crores in favour of the Odisha Mining Corporation Limited and subsequently, the Company has allotted the One Zero Coupon Unsecured Redeemable Non-Convertible Debentures of ₹ 3 Crores, in favour of the Odisha Mining Corporation Limited, on September 21<sup>st</sup>, 2021.

**Navneet Bathla**  
Associate Partner  
ACS:43605 /CP No. 20939  
UDIN: A043605D000335028

**For BNP & Associates**  
Company Secretaries  
[Firm Regn. No. P2014MH037400]  
PR No. 637/2019

**Place: Mumbai**  
**Date: 17<sup>th</sup> May, 2022**



# Annexure VB

## Annexure A

To,

**The Members,  
Utkal Alumina International Limited**

Secretarial Audit Report of even date is to be read along with this letter.

- The compliance of provisions of all laws, rules, regulations, standards applicable to **Utkal Alumina International Limited (the 'Company')** is the responsibility of the management of the Company. Our examination was limited to the verification of records and procedures on test check basis for the purpose of issue of the Secretarial Audit Report.
- Maintenance of secretarial and other records of applicable laws is the responsibility of the management of the Company. Our responsibility is to issue Secretarial Audit Report, based on the audit of the relevant records maintained and furnished to us by the Company, along with explanations where so required.
- We have followed the audit practices and processes as were appropriate to obtain reasonable assurance about the correctness of the contents of the secretarial and other legal records, legal compliance mechanism and corporate conduct. The verification was done on test check basis to ensure that correct facts as reflected in

secretarial and other records produced to us. We believe that the processes and practices we followed, provides a reasonable basis for our opinion for the purpose of issue of the Secretarial Audit Report.

- We have not verified the correctness and appropriateness of financial records and Books of Accounts of the Company.
- Wherever required, we have obtained the management representation about the compliance of laws, rules and regulations and major events during the audit period.
- The Secretarial Audit Report is neither an assurance as to the future viability of the Company nor of the efficacy or effectiveness with which the management has conducted the affairs of the Company.

**Navneet Bathla**  
Associate Partner  
ACS:43605 /CP No. 20939  
UDIN: A043605D000335028

Place: Mumbai  
Date: 17<sup>th</sup> May, 2022

For BNP & Associates  
Company Secretaries  
[Firm Regn. No. P2014MH037400]  
PR No. 637/2019

# Annexure VI

## Format for the Annual Report on CSR Activities

### 1. Brief Outline on CSR Policy of the Company:

For every Company in the Aditya Birla Group, reaching out to underserved communities is a part of our DNA. We believe in the trusteeship concept. This entails transcending business interest and grappling with the "quality of life" challenges that underserved communities face, and working towards making a meaningful differences to them.

Our vision is – "to actively contribute to the social and economic development of the underserved communities, lifting the burden of poverty and helping bring in inclusive growth, in so doing build a better, sustainable way of life for the weaker sections of society and raise the country's human development index", (Mrs. Rajashree Birla, Chairperson, Aditya Birla Centre for Community Initiatives and Rural development)

### 2. Composition of CSR Committee:

Sl. No.	Name of Director	Designation / Nature of Directorship	Number of meetings of CSR committee held during the year	Number of meetings of CSR Committee attended during the year
1	Smt. Rajashree Birla	Chairperson/Non-Executive Director	1	1
2	Mr. Y.P. Dandiwala	Member/Independent Director	1	1
3	Mr. Satish Pai	Member/Managing Director	1	1
4	Mr. A.K. Agarwala	Member/Non-Executive Director	1	1
5	Mr. D. Bhattacharya	Member/Non-Executive Director	1	1

\* Mr. D Bhattacharya (Member/Non-Executive Director) Resigned w.e.f 2nd March, 2022.

### 3. Provide the web link where composition of CSR Committee, CSR policy and CSR projects approved by the Board are disclosed on the website of the Company

[www.hindalco.com](http://www.hindalco.com)

### 4. Provide the details of Impact Assessment of CSR Projects carried out in pursuance of sub rule (3) of rule 8 of Companies (Corporate Social Responsibility Policy) Rules 2014 if applicable:

*No Impact study has been carried out in this Financial Year*

### 5. Details of the Amount available for set off in pursuance of sub rule (3) of rule 7 of Companies (Corporate Social Responsibility Policy) Rules 2014 and amount required for set off for financial year if any

Sl. No.	Financial Year	Amount available for set off from preceding financial year (₹ In Cr)	Amount required to be set off for the financial year if any (₹ In Cr)
1	2021-22	12.36	Nil
	<b>Total</b>	12.36	Nil

### 6. Average Net Profit of the Company as per Section 135(5)

₹ 1,205.90 Crore

### 7. (a) Two percent of average net profit of the Company as per Section 135(5)

₹ 24.12 Crore

### (b) Surplus arising out of CSR projects or programs or activities of previous financial years

Nil

## Annexure VI

(c) Amount required to be set off for the financial years , if any  
Nil

(d) Total CSR Obligation for the financial year (7a+7b-7c)  
₹ 24.12 Crore

### 8. (a) CSR Amount Spent or Unspent for the financial year

Total Amount Spent for the Financial Year (₹ in Lakhs)	Amount Unspent (In ₹)				
	Total Amount transferred to Unspent CSR Account as per section 135(6).		Amount transferred to any fund specified under Schedule VII as per second proviso to section 135(5).		
	Amt	Date of Transfer	Name of the Fund	Amount	Date of Transfer
3,755.00	NA	NA	NA	NA	NA

(b) Details of CSR amount spent against ongoing projects for the financial year: Nil

1	2	3	4	5	6	7	8	9	10	11
Sl. No.	Name of the Project	Item from the list of activities in Schedule VII to the Act	Local Area (Yes/No)	Location of the Project	Project Duration	Amount allocated for the project (In ₹)	Amount Spent in the Current FY (In ₹)	Amount Transferred to Unspent CSR account for the project as per Section 135(6) (In ₹)	Mode of Implementation Direct (Yes/No)	Mode of Implementation - Through Implementing Agency
			State	District			Name	CSR Registration Number		
Nil										

(c) Details of CSR amount spent against other than ongoing projects for the financial year:

1	2	3	4	5	6	7	8		
Sr No	Name of the Project	Item from the list of activities in Schedule VII to the Act	Local Area (Yes/No)	Location of the Project	Amount spent for the project (₹ In Lakhs)	Mode of Implementation Direct (Yes/No)	Mode of Implementation -Through Implementing Agency		
			State	District			Name	CSR Registration Number	
1	Pre school education	Promoting education, including special education and employment enhancing vocational skills	Renukoot, Renusagar, Samri, Lohardaga, Mahan, Belagaum, Kathautia	UP, Chatisgarh, Jharkhand, Madhya Pradesh, Karnataka	Sonebhadra, Balarampur, Lohardaga, Singrauli, Belagavi, Palamau	39.56	YES	NA	NA
2	School Education Program	Promoting education, including special education and employment enhancing vocational skills	Dumri,Gare Palma, Mahan, Aditya, Renukoot, Renusagar, Samri, Lohardaga, Alupuram, Taloja, Muri,Belagaum	Jharkhand, Chhattisgarh, UP, Odisha, Kerala, Maharashtra, Karnataka	Hazaribag, Raigarh, Singrauli, Sambalpur, Sonebhadra, Balarampur, Lohardaga, Ernakulam, Raigad, Belagavi	1168.616	YES	NA	NA

1	2	3	4	5	6	7	8		
Sr No	Name of the Project	Item from the list of activities in Schedule VII to the Act	Local Area (Yes/No)	Location of the Project	Amount spent for the project (₹ In Lakhs)	Mode of Implementation Direct (Yes/No)	Mode of Implementation -Through Implementing Agency		
			State	District			Name	CSR Registration Number	
3	Education support programs	Promoting education, including special education and employment enhancing vocational skills	Belgaum, Renukoot, Renusagar, Samri, Lohardaga, Mahan, Gare Palma	Karnataka, UP, Chatisgarh, Jharkhand, MP, Chhattisgarh	Belagavi, Sonebhadra, Balarampur, Lohardaga, Singrauli, Raigarh	20.233	YES	NA	NA
4	Vocational and Technical Education	Promoting education, including special education and employment enhancing vocational skills	Taloja,Chakla, Dumri, Lohardaga	Maharashtra Jharkhand	Raigad,Latehar Hazaribag, Lohardaga	22.116	YES	NA	NA
5	School Infrastructure	Promoting education, including special education and employment enhancing vocational skills	Belgaum,Belur, Taloja, Mahan, Renukoot, Lohardaga, Samri, Garepalma	Karnataka, West Bengal Maharashtra, MP, UP, Jharkhand, Chhattisgarh	Belagavi, Howrah, Raigad, Singrauli, Sonebhadra, Lohardaga, Balarampur, Raigarh	1033.197	YES	NA	NA
6	Preventive health	Eradicating hunger, poverty and malnutrition, promoting health care, sanitation and safe drinking water.	Belagaum, Alupuram, Renukoot, Renusagar, Lohardaga, Samri,Mouda, Aditya, Mahan, Garepalma Kathautia,	Karnataka Kerala UP, Jharkhand, Maharashtra, Chhattisgarh, Odisha, MP	Belagavi Ernakulam, Sonebhadra, Lohardaga, Balarampur, Nagpur, Sambalpur, Singrauli, Raigarh, Palamau	120.977	YES	NA	NA
7	Curative Health Care program	Eradicating hunger, poverty and malnutrition, promoting health care, sanitation and safe drinking water.	Belagaum, Taloja Renukoot, Renusagar, Lohardaga, Samri, Mouda, Mahan, Garepalma	Karnataka, Maharashtra, UP, Jharkhand, Chhattisgarh, MP	Belagavi, Raigad, Sonebhadra, Lohardaga, Balarampur, Nagpur, Raigarh	234.544	YES	NA	NA
8	Reproductive and Child Health	Eradicating hunger, poverty and malnutrition, promoting health care, sanitation and safe drinking water.	Renukoot, Renusagar, Lohardaga, Samri, Mahan, Gare Palma, Kathautia, Dumri	UP, Jharkhand, Chhattisgarh, MP, Jharkhand,	Sonebhadra, Lohardaga, Balarampur, Singrauli, Palamu, Raigarh, Hazaribag	146.541	YES	NA	NA



## Annexure VI

1	2	3	4	5	6	7	8		
Sr No	Name of the Project	Item from the list of activities in Schedule VII to the Act	Local Area (Yes/No)	Location of the Project		Amount spent for the project (₹ In Lakhs)	Mode of Implementation Direct (Yes/No)	Mode of Implementation -Through Implementing Agency	
				State	District			Name	CSR Registration Number
9	Quality / Support Program	Eradicating hunger, poverty and malnutrition, promoting health care, sanitation and safe drinking water.	Belur, Silvassa, Renukoot, Renusagar, Lohardaga, Mahan, Gare Palma	West Bengal, UT of DNH & DD, UP, Jharkhand, MP, Chhatisgarh	Howrah, Dadra and Nagar Haveli, Singrauli, Sonebhadra, Lohardaga, Raigarh	44.791	YES	NA	NA
10	Health Infrastructure	Eradicating hunger, poverty and malnutrition, promoting health care, sanitation and safe drinking water.	Belgaum, Alupuram, Renukoot, Renusagar, Lohardaga, Samri, Mouda, Mahan, Gare Palma	Karnataka, Kerala, MP, UP, Chhattisgarh, Jharkhand, Maharashtra	Belagavi, Ernakulam, Singrauli, Sonebhadra, Raigarh, Lohardaga, Nagpur	106.621	YES	NA	NA
11	Agriculture and Farm Based	Ensuring environmental sustainability, ecological balance, animal welfare, agroforestry, conservation of natural resources and maintaining quality of soils, air and water.	Belagaum, Mahan, Aditya, Garepalma, Renukoot, Renusagar, Samri	Karnataka, UP, MP, Odisha, Chhattisgarh,	Belagavi, Singrauli, Raigarh, Sonebhadra, Balarampur	78.719	YES	NA	NA
12	Animal Husbandary Based	Ensuring environmental sustainability, ecological balance, animal welfare, agroforestry, conservation of natural resources and maintaining quality of soils, air and water.	Belagaum, Renukoot, Renusagar, Samri, Mahan	Karnataka, UP, Chattisgarh, MP	Belagavi, Sonebhadra, Balarampur, Singrauli	32.075	YES	NA	NA
13	Non farm & Skills Based Income generation Program	Ensuring environmental sustainability, ecological balance, animal welfare, agroforestry, conservation of natural resources and maintaining quality of soils, air and water.	Mahan, Renukoot, Renusagar, Lohardaga, Samri, Belagaum, Garepalma	MP, UP, Jharkhand, Chattisgarh, Karnataka	Singrauli, Sonebhadra, Lohardaga, Balarampur, Belagavi, Raigarh	90.065	YES	NA	NA

1	2	3	4	5	6	7	8		
Sr No	Name of the Project	Item from the list of activities in Schedule VII to the Act	Local Area (Yes/No)	Location of the Project		Amount spent for the project (₹ In Lakhs)	Mode of Implementation Direct (Yes/No)	Mode of Implementation -Through Implementing Agency	
				State	District			Name	CSR Registration Number
14	Natural Resource conservation programs & Non conventional Energy	Ensuring environmental sustainability, ecological balance, animal welfare, agroforestry, conservation of natural resources and maintaining quality of soils, air and water.	Chakla Renukoot, Renusagar, Lohardaga, Samri, Balgaum, Garepalma	Jharkhand UP, Chattisgarh, Karnataka	Latehar, Soenbhadra, Lohardaga, Balarampur, Belagavi, Raigarh	82.712	YES	NA	NA
15	Livelihood Infrastructure	Ensuring environmental sustainability, ecological balance, animal welfare, agroforestry, conservation of natural resources and maintaining quality of soils, air and water.	Mahan, Renukoot, Lohardaga, Samri	MP, UP, Jharkhand, Chattisgarh	Singrauli, Sonebhadra, Lohardaga, Balarampur	75.106	YES	NA	NA
16	Institutional building & strengthening	Promoting gender equality, empowering women, setting up orphanages & reduce inequalities	Belgaum, Mahan, Renukoot, Lohardaga, Kathautia	Karnataka, MP, UP, Jharkhand	Belagavi, Singrauli, Sonebhadra, Lohardaga, Palamau	49.613	YES	NA	NA
17	Social Security	Promoting gender equality, empowering women, setting up orphanages & reduce inequalities	Mahan, Gare Palma, Lohardaga, Kathautia, Chakla	MP, Chattisgarh, Jharkhand	Singrauli, Raigarh, Lohardaga, Palamau, Latehar	32.036	YES	NA	NA
18	Awareness programmes	Promoting gender equality, empowering women, setting up orphanages & reduce inequalities	Belagaum, Taloja, Renukoot, Lohardaga, Samri, Mahan, Kathautia, Gare Palma, Dumri, Chakla	Karnataka, Maharashtra, UP, Jharkhand, Chhattisgar, MP	Belagavi, Raigad, Sonebhadra, Lohardaga, Raigarh, Singrauli, Palamau, Balarampur, Hazaribagh, Latehar	61.096	YES	NA	NA

## Annexure VI

1	2	3	4	5	6	7	8		
Sr No	Name of the Project	Item from the list of activities in Schedule VII to the Act	Local Area (Yes/No)	Location of the Project	Amount spent for the project (₹ In Lakhs)	Mode of Implementation Direct (Yes/No)	Mode of Implementation -Through Implementing Agency		
			State	District			Name CSR Registration Number		
19	Social Events to minimise causes of poverty	Promoting gender equality, empowering women, setting up orphanages & reduce inequalities	Belgaum, Alupuram, Renukoot, Renusagar, Lohardaga, Samri, Mahan, Kathautia	Karnataka, Kerala, MP, UP, Chhatisgarh, Jharkhand	Belagavi,Ernakulam, Singrauli, Sonebhadra, Balarampur, Palamau	13.688	YES	NA	NA
20	Promotion of heritage/culture/ Sports	Protection of national heritage, art and culture. Training to promote rural sports, Paralympic Sports & Olympic Sports	Belgaum, Mahan, Aditya, Renukoot, Gare Palma	Karnataka, MP, Odisha, UP, Chhattisgarh	Belagavi, Singrauli, Sambalpur, Sonebhadra, Raigarh	17.571	YES	NA	NA
21	Disaster Relief Programmes	Disaster Management & Relief Activities.	Taloja, Silvassa, Mahan	Maharashtra, UT of DNH & DD, MP	Raigad, Dadra & Nagar Haveli, Singrauli	4.841	YES	NA	NA
22	Promotion of rural sports	Protection of national heritage, art and culture. Training to promote rural sports, Paralympic Sports & Olympic Sports	Muri, Renukoot, Renusagar, Lohardaga, Samri, Aditya	Jharkhand, UP, Chattisgarh, Odisha	Ranchi, Sonebhadra, Lohardaga, Balarampur, Sambalpur	49.029			
23	Rural Infrastructure Development	Rural development projects.	Belagaum, Taloja, Renukoot, Renusagar, Lohardaga, Mahan, Garepalma	Karnataka, Maharashtra, UP, Chhattisgarh	Belagavi, Raigad, Sonebhadra, Lohardaga, Singrauli, Raigarh	48.537	YES	NA	NA
24	COVID 19 relief	Eradicating hunger, poverty and malnutrition, promoting health care, sanitation and safe drinking water.	Belur, Taloja, Alupuram, Renukoot, Renusagar, Lohardaga, Samri, Mahan, Garepalma,	West Bengal, Maharashtra, UP, Jharkhand, Chattisgarh, MP	Howrah, Raigad, Ernakulam, Sonebhadra, Lohardaga, Balarampur, Raigarh	82.608			
<b>Total (In lakhs)</b>					<b>3654.892</b>				

(d) **Amount Spent in Administrative Overheads:**

₹ 100.03 Lakhs

(e) **Amount Spent on Impact Assessment, if applicable**

Nil

(f) **Total Amount Spent for the financial year (8b+8c+8d+8e)**

₹ 3754.922 Lakhs including Administrative Overheads

(g) **Excess Amount for Set off if any:**

Sl No	Particular	₹ In Lakhs
(i)	Two percent of Average Net Profit of the Company as per Section 135(5)	2,412.00
(ii)	CSR Amount spent for Financial Year	3,755.00
(iii)	CSR Amount claimed during the Financial year	2,585.00
(iv)	Excess Amount Spent for Financial Year [(ii-iii)]	1,170.00
(v)	CSR amount excess spent of the previous financial years, if any	1,236.00
(vi)	Amount available for set-off in succeeding financial Year [(iv+v)]	2,406.00

9. (a) **Details of Unspent CSR Amount for the preceding three Financial Years: Nil**

Sl No.	Preceding Financial Year	Amount Transferred to Unspent CSR Account under Section 135(6)	Amount spent in Reporting Financial Year (In ₹)	Amount Transferred to any fund specified in Schedule VII as per Section 135(6) if any			Amount remaining to be spent in succeeding financial years (In ₹)
				Name of the Fund	Amt in ₹	Date of Transfer	
NA							

(b) **Details of CSR Amount Spent in the financial year for ongoing projects of the preceding financial year(s): Nil**

1	2	3	4	5	6	7	8	9
Sl No.	Project ID	Name of the Project	Financial Year in which the project was commenced	Project Duration	Total Amount allocated for the Project (In ₹)	Amount spent on the Project in the Reporting Financial Year (In ₹)	Cumulative Amount Spent at the end of Reporting Financial Year (In ₹)	Status of the Project Completed/ Ongoing
NA								

10. **In case of creation or acquisition of capital asset, furnish the details relating to the asset so created or acquired through CSR spent in the Financial Year**

Date of creation or Acquisition of the capital asset (s)	Amount of CSR spent for creation or acquisition of capital assets (s) (₹)	Details of the entity or public authority or beneficiaries under whose name such capital asset is registered, their address etc.			Provide details of the capital asset (s) created or acquired (including complete address and location of the capital asset)
		Name (Place)	Address	Contact Number	
12.02.2022	59,800	Barahwatola	Hand Pump, (Gram Panchayat) Near Arjun Sahu House, Gram: barahwatola, Post: Daga Bargawan, Tehsil: Deosar, Dist. Singrauli, Madhya Pradesh, Pin: 486886	7471148259	HandPump, (Gram Panchayat) Near Arjun Sahu House, Gram: barahwatola, Post: Daga Bargawan, Tehsil: Deosar, Dist. Singrauli, Madhya Pradesh, Pin: 486886
14.02.2022	50,200	Bargawan	Hand pump, (Gram Panchayat) Near Boys Hostel (Aadiwasi), Gram: Bargawan, Post: Daga, Tehsil: Deosar, Dist. Singrauli, Madhya Pradesh, Pin: 486886	9617909136	Hand pump, (Gram Panchayat) Near Boys Hostel (Aadiwasi), Gram: Bargawan, Post: Daga, Tehsil: Deosar, Dist. Singrauli, Madhya Pradesh, Pin: 486886



## Annexure VI

Date of creation or Acquisition of the capital asset (s)	Amount of CSR spent for creation or acquisition of capital assets (s) (₹)	Details of the entity or public authority or beneficiaries under whose name such capital asset is registered, their address etc.			Provide details of the capital asset (s) created or acquired (including complete address and location of the capital asset)
		Name (Place)	Address	Contact Number	
22.02.2022	62,200	Daga	Hand pump , (Gram Panchayat ) Near ITI Collage , Gram: Daga, Post: Daga Bargawan, Tehsil: Deosar, Dist. Singrauli, Madhya Pradesh, Pin: 486886	7987595504	Hand pump , (Gram Panchayat ) Near ITI Collage , Gram: Daga, Post: Daga Bargawan, Tehsil: Deosar, Dist. Singrauli, Madhya Pradesh, Pin: 486886
24.02.2022	62,200	Kanai	Hand pump , (Gram Panchayat ) Near BudhSagar house, Gram: Kanei, Post: Daga Bargawan, Tehsil: Deosar, Dist. Singrauli, Madhya Pradesh, Pin: 486886	8463075287	Hand pump , (Gram Panchayat ) Near BudhSagar house, Gram: Kanei, Post: Daga Bargawan, Tehsil: Deosar, Dist. Singrauli, Madhya Pradesh, Pin: 486886
23.02.2022	52,600	Bareniya	Hand pump , (Gram Panchayat ) Near Hindalco Gate No 4, Gram: Bareniya, Post: Daga Bargawan, Tehsil: Deosar, Dist. Singrauli, Madhya Pradesh, Pin: 486886	9669722567	Hand pump , (Gram Panchayat ) Near Hindalco Gate No 4, Gram: Bareniya, Post: Daga Bargawan, Tehsil: Deosar, Dist. Singrauli, Madhya Pradesh, Pin: 486886
25.02.2022	73,000	Bhalugarh	Hand pump, (Gram Panchayat ) Near Orphanage, Gram: Bhalugadh, Post: Gondwali, Tehsil: Chitrangi, Dist. Singrauli, Madhya Pradesh, Pin: 486892	9753350660	Hand pump, (Gram Panchayat ) Near Orphanage, Gram: Bhalugadh, Post: Gondwali, Tehsil: Chitrangi, Dist. Singrauli, Madhya Pradesh, Pin: 486892
21.02.2022	71,800	Badokhar	Hand pump , (Gram Panchayat ) Vishwakarma Basti, Gram: Badokhar, Post: Daga Bargawan, Tehsil: Deosar, Dist. Singrauli, Madhya Pradesh, Pin: 486886	8815915171	Hand pump , (Gram Panchayat ) Vishwakarma Basti, Gram: Badokhar, Post: Daga Bargawan, Tehsil: Deosar, Dist. Singrauli, Madhya Pradesh, Pin: 486886
15.02.2022	57,400	Khekhda	Hand pump, (Gram Panchayat ) Pahridand, Gram: Jobgadh, Post: Bargawan, Tehsil: Deosar, Dist. Singrauli, Madhya Pradesh, Pin: 486886	8435382011	Hand pump, (Gram Panchayat ) Pahridand, Gram: Jobgadh, Post: Bargawan, Tehsil: Deosar, Dist. Singrauli, Madhya Pradesh, Pin: 486886
08.03.2022	71,800	Baghbudwa	Hand pump, (Gram Panchayat ) Near Higher Secondary School, Gram: Bagbudwa, Post: Chanduwar, Tehsil: Deosar, Dist. Singrauli, Madhya Pradesh, Pin: 486881	7999247827	Hand pump, (Gram Panchayat ) Near Higher Secondary School, Gram: Bagbudwa, Post: Chanduwar, Tehsil: Deosar, Dist. Singrauli, Madhya Pradesh, Pin: 486881
08.03.2022	69,400	Sajhar	Hand pump, (Gram Panchayat ) Jogni, Gram: Sajhar, Post: Chanduwar, Tehsil: Deosar, Dist. Singrauli, Madhya Pradesh, Pin: 486881	8965990357	Hand pump, (Gram Panchayat ) Jogni, Gram: Sajhar, Post: Chanduwar, Tehsil: Deosar, Dist. Singrauli, Madhya Pradesh, Pin: 486881

Date of creation or Acquisition of the capital asset (s)	Amount of CSR spent for creation or acquisition of capital assets (s) (₹)	Details of the entity or public authority or beneficiaries under whose name such capital asset is registered, their address etc.			Provide details of the capital asset (s) created or acquired (including complete address and location of the capital asset)
		Name (Place)	Address	Contact Number	
02.03.2022	1,29,200	Baghadih	Hand pump, (Gram Panchayat ) Adiwasi Basti Lahwabadand, Gram: Baghadih, Post: Odgadi, Tehsil: Deosar, Dist. Singrauli, Madhya Pradesh, Pin: 486899	9993459330	Hand pump, (Gram Panchayat ) Adiwasi Basti Lahwabadand, Gram: Baghadih, Post: Odgadi, Tehsil: Deosar, Dist. Singrauli, Madhya Pradesh, Pin: 486899
05.03.2022	1,32,800	Orgadi	Hand pump, (Gram Panchayat ) Semradand & Chuna Bhatta , Gram: Odgadi, Post: Odgadi, Tehsil: Deosar, Dist. Singrauli, Madhya Pradesh, Pin: 486886	8889434071	Hand pump, (Gram Panchayat ) Semradand & Chuna Bhatta , Gram: Odgadi, Post: Odgadi, Tehsil: Deosar, Dist. Singrauli, Madhya Pradesh, Pin: 486886
26.02.2022	73,960	Gidher	Hand pump , (Gram Panchayat ) Adiwasi Basti Inside Gidher Tower on Durghata Devi Road, Gram: Gidher, Post: Odgadi, Tehsil: Deosar, Dist. Singrauli Madhya Pradesh, Pin: 486886	8463012902	Hand pump , (Gram Panchayat ) Adiwasi Basti Inside Gidher Tower on Durghata Devi Road, Gram: Gidher, Post: Odgadi, Tehsil: Deosar, Dist. Singrauli Madhya Pradesh, Pin: 486886
26.02.2022	59,800	Pokhra	Hand pump, (Gram Panchayat ) Near Upswastha Kendra, Gram: Pokhara, Post: Pokhra, Tehsil: Deosar, Dist. Singrauli, Madhya Pradesh, Pin: 486892	7354625044	Hand pump, (Gram Panchayat ) Near Upswastha Kendra, Gram: Pokhara, Post: Pokhra, Tehsil: Deosar, Dist. Singrauli, Madhya Pradesh, Pin: 486892
27.02.2022	68,200	Dharsada	Hand pump, (Gram Panchayat ) Near Shivdhari Bais house, Gram: Dharsada, Post: Pateri, Tehsil: Chitrangi, Dist. Singrauli, Madhya Pradesh, Pin: 486892	9630028960	Hand pump, (Gram Panchayat ) Near Shivdhari Bais house, Gram: Dharsada, Post: Pateri, Tehsil: Chitrangi, Dist. Singrauli, Madhya Pradesh, Pin: 486892
28.02.2022	73,000	Ghinhagaon	Hand pump, (Gram Panchayat ) Near Shiv Madir, Gram: Ghinhagao, Post: Pateri, Tehsil: Deosar, Dist. Singrauli, Madhya Pradesh, Pin: 486892	6268218489	Hand pump, (Gram Panchayat ) Near Shiv Madir, Gram: Ghinhagao, Post: Pateri, Tehsil: Deosar, Dist. Singrauli, Madhya Pradesh, Pin: 486892
28.02.2022	1,31,600	Majhigawan	Hand pump , (Gram Panchayat ) Karri Tola & Sakra Tola, Gram: Majhigawan, Post: Pokhara, Tehsil: Deosar, Dist. Singrauli Madhya Pradesh, Pin: 486892	7000062251	Hand pump , (Gram Panchayat ) Karri Tola & Sakra Tola, Gram: Majhigawan, Post: Pokhara, Tehsil: Deosar, Dist. Singrauli Madhya Pradesh, Pin: 486892

11. Specify the reason(s), if the company has failed to spend two percent of the average net profit as per Section 135(5) -  
*Not applicable*

**Mr. Satish Pai**  
(Managing Director)  
(DIN: 06646758)

**Mrs. Rajashree Birla**  
(Chairman, CSR Committee)  
(DIN: 00022995)

Place : Mumbai  
Dated : 6<sup>th</sup> May, 2022

# Annexure VII

## FINANCIAL INFORMATION RELATING TO SUBSIDIARY COMPANIES FOR THE YEAR ENDED 31ST MARCH 2022 Sec.129(3)

Sr.	Name of the Subsidiary Company	Country	Reporting currency	Capital	Reserves	Total Assets	Total Liabilities	Investments Shares, Debiture, Bonds & Others	Turnover/ Revenues	Profit/(Loss) before Tax	Provision for Tax	Gain/Loss from discontinued Operations	Profit/(Loss) after Tax	Proposed Dividend	% of Share Holding
1	Minerals and Minerals Limited	India	INR	0.05	13.60	32.45	18.80	-	46.36	4.21	1.38	-	2.84	-	100
2	Renuka Investment and Finance Limited	India	INR	34.25	200.72	238.64	3.67	233.42	3.65	3.08	2.43	-	0.65	-	100
3	Renukeshwar Investment and Finance Limited	India	INR	4.80	132.37	137.93	0.76	137.87	3.61	3.60	4.44	-	(0.84)	-	100
4	Suvas Holding Limited	India	INR	29.93	(2.83)	35.98	6.33	0.05	3.51	0.22	0.05	-	0.17	-	74
5	Utkal Alumina International Limited	India	INR	6,251.48	2,847.99	13,050.72	3,951.25	651.94	4,741.65	1,701.34	602.18	-	1,099.16	-	100
6	Hindalco-Almax Aerospace Limited	India	INR	88.56	17.71	112.49	6.22	41.93	126.65	8.32	0.47	-	7.85	-	97
7	Lucknow Finance Company Limited	India	INR	9.90	9.51	20.56	1.14	11.63	2.65	2.24	0.34	-	1.90	-	100
8	Dahaj Harbour and Infrastructure Limited	India	INR	50.00	45.01	133.06	38.05	90.04	57.58	20.97	7.72	-	13.25	-	100
9	East Coast Bauxite Mining Co.Pvt.Ltd.	India	INR	0.01	(0.05)	0.01	0.04	-	-	(0.00)	-	-	(0.00)	-	74
10	Utkal Alumina Social Welfare Foundation	India	INR	0.10	0.01	0.24	0.12	-	-	0.03	-	-	0.03	-	100
11	Kosala Livelihood and Social Foundation	India	INR	1.6	(0.39)	1.38	0.17	-	0.41	(0.39)	-	-	(0.39)	-	100
12	Birla Copper ASOJ Private Limited (Erstwhile Ryker Base Pvt Ltd)	India	INR	52.02	22.74	276.68	201.92	-	87.38	(5.99)	(1.53)	-	(4.46)	-	100
13	A V Minerals ( Netherlands) N.V. *	Netherlands	INR	12,590.63	(1,433.80)	11,156.83	-	-	-	(250.04)	-	-	(250.04)	-	100
14	A V Metals Inc. #*	Canada	USD	1,658.74	(888.89)	1,469.84	-	-	-	(33.57)	-	-	(33.57)	-	100
15	Novelis Inc.*	Canada	INR	11,234.67	1,286.26	23,375.15	10,854.23	-	5,082.27	4,601.12	(380.74)	(38.33)	4,943.54	-	100
16	4260848 Canada Inc.*	Canada	USD	1,480.00	169.44	3,079.32	1,429.88	-	682.24	617.65	(51.11)	(5.14)	663.62	-	100
17	4260856 Canada Inc.*	Canada	INR	930.98	(630.78)	305.50	5.29	-	209.63	11.52	-	-	198.11	-	100
18	Novelis South America Holdings LLC*	USA	USD	122.64	(83.10)	40.24	0.70	-	28.14	1.55	-	-	26.59	-	100
19	Novelis Corporation*	USA	INR	0.30	(5,017.95)	43,534.39	48,552.04	-	45,940.47	238.38	(14.90)	-	253.28	-	100
20	Novelis de Mexico SA de CV*	Mexico	USD	0.04	(661.04)	5,735.00	6,396.00	-	6,167.00	32.00	(2.00)	-	34.00	-	100
21	Novelis do Brasil Ltda.*	Brazil	INR	0.05	(0.01)	-	-	-	-	-	-	-	-	-	100
22	Novelis Korea Limited*	South Korea	BRL	1,530.77	4,460.18	15,573.88	9,582.94	-	19,528.52	3,543.18	905.14	-	2,638.03	-	100
23	Novelis UK Ltd*	United Kingdom	INR	958.53	2,792.85	9,751.96	6,000.59	-	13,967.20	2,534.15	647.38	-	1,886.78	-	100
24	Novelis Services Limited*	United Kingdom	INR	2,603.15	768.99	12,931.85	9,559.71	-	19,822.81	404.20	117.54	-	286.66	-	100
25	Novelis Deutschland GmbH*	Germany	KRW	416,777.00	123,119.00	2,070,454.00	1,530,558.00	-	3,173,731.00	64,714.00	18,818.00	-	45,896.00	-	100
26	Novelis Aluminium Beteiligungs GmbH*	Germany	INR	1,457.60	1,279.67	4,157.63	1,420.36	-	4,742.62	302.95	47.57	-	255.38	-	100
27	Novelis Switzerland SA*	Switzerland	GBP	2,864.73	37.58	13,488.72	10,586.40	-	29,831.71	(979.78)	0.02	-	(979.79)	-	100
28	Novelis Italia SPA*	Italy	EUR	340.80	4.47	1,604.65	1,259.39	-	3,446.03	(113.18)	0.00	-	(113.18)	-	100
29	Novelis Aluminium Holding Unlimited Company*	Ireland	INR	0.21	0.18	0.39	-	-	-	-	-	-	-	-	100
30	Novelis PAE SAS*	France	EUR	0.03	0.02	0.05	-	-	-	-	-	-	-	-	100
31	Novelis Europe Holdings Limited*	United Kingdom	INR	41.14	3,647.96	5,677.95	1,988.86	-	6,728.53	22.66	0.21	-	22.46	-	100
			CHF	5.00	443.41	690.16	241.75	-	829.77	2.80	0.03	-	2.77	-	100
			INR	452.71	200.63	1,574.62	921.28	-	2,728.83	96.42	7.40	-	89.02	-	100
			EUR	53.86	23.87	187.32	109.60	-	315.22	11.14	0.86	-	10.28	-	100
			INR	1,824.91	(33.55)	8,808.09	7,016.73	-	(1,173.75)	(441.89)	-	-	(731.86)	-	100
			EUR	217.10	(3.99)	1,047.83	834.73	-	(135.59)	(51.05)	-	-	(84.54)	-	100
			INR	33.96	151.61	324.96	139.40	-	101.26	2.00	(0.15)	-	2.15	-	100
			EUR	4.04	18.04	38.66	16.58	-	11.70	0.23	(0.02)	-	0.25	-	100
			INR	372.70	1,599.39	5,732.09	3,760.00	-	(153.09)	-	-	-	(153.09)	-	100
			USD	49.10	210.70	755.12	495.32	-	(20.55)	-	-	-	(20.55)	-	100

Sr.	Name of the Subsidiary Company	Country	Reporting currency	Capital	Reserves	Total Assets	Total Liabilities	Investments Shares, Debiture, Bonds & Others	Turnover/ Revenues	Profit/(Loss) before Tax	Provision for Tax	Gain/Loss from discontinued Operations	Profit/(Loss) after Tax	Proposed Dividend	% of Share Holding
19	Novelis Corporation*	USA	INR	0.30	(5,017.95)	43,534.39	48,552.04	-	45,940.47	238.38	(14.90)	-	253.28	-	100
20	Novelis de Mexico SA de CV*	Mexico	USD	0.04	(661.04)	5,735.00	6,396.00	-	6,167.00	32.00	(2.00)	-	34.00	-	100
21	Novelis do Brasil Ltda.*	Brazil	INR	1,530.77	4,460.18	15,573.88	9,582.94	-	19,528.52	3,543.18	905.14	-	2,638.03	-	100
22	Novelis Korea Limited*	South Korea	BRL	958.53	2,792.85	9,751.96	6,000.59	-	13,967.20	2,534.15	647.38	-	1,886.78	-	100
23	Novelis UK Ltd*	United Kingdom	INR	2,603.15	768.99	12,931.85	9,559.71	-	19,822.81	404.20	117.54	-	286.66	-	100
24	Novelis Services Limited*	United Kingdom	KRW	416,777.00	123,119.00	2,070,454.00	1,530,558.00	-	3,173,731.00	64,714.00	18,818.00	-	45,896.00	-	100
25	Novelis Deutschland GmbH*	Germany	INR	1,457.60	1,279.67	4,157.63	1,420.36	-	4,742.62	302.95	47.57	-	255.38	-	100
26	Novelis Aluminium Beteiligungs GmbH*	Germany	GBP	2,864.73	37.58	13,488.72	10,586.40	-	29,831.71	(979.78)	0.02	-	(979.79)	-	100
27	Novelis Switzerland SA*	Switzerland	EUR	340.80	4.47	1,604.65	1,259.39	-	3,446.03	(113.18)	0.00	-	(113.18)	-	100
28	Novelis Italia SPA*	Italy	INR	0.21	0.18	0.39	-	-	-	-	-	-	-	-	100
29	Novelis Aluminium Holding Unlimited Company*	Ireland	EUR	0.03	0.02	0.05	-	-	-	-	-	-	-	-	100
30	Novelis PAE SAS*	France	INR	41.14	3,647.96	5,677.95	1,988.86	-	6,728.53	22.66	0.21	-	22.46	-	100
31	Novelis Europe Holdings Limited*	United Kingdom	CHF	5.00	443.41	690.16	241.75	-	829.77	2.80	0.03	-	2.77	-	100
			INR	452.71	200.63	1,574.62	921.28	-	2,728.83	96.42	7.40	-	89.02	-	100
			EUR	53.86	23.87	187.32	109.60	-	315.22	11.14	0.86	-	10.28	-	100
			INR	1,824.91	(33.55)	8,808.09	7,016.73	-	(1,173.75)	(441.89)	-	-	(731.86)	-	100
			EUR	217.10	(3.99)	1,047.83	834.73	-	(135.59)	(51.05)	-	-	(84.54)	-	100
			INR	33.96	151.61	324.96	139.40	-	101.26	2.00	(0.15)	-	2.15	-	100
			EUR	4.04	18.04	38.66	16.58	-	11.70	0.23	(0.02)	-	0.25	-	100
			INR	372.70	1,599.39	5,732.09	3,760.00	-	(153.09)	-	-	-	(153.09)	-	100
			USD	49.10	210.70	755.12	495.32	-	(20.55)	-	-	-	(20.55)	-	100



Figures INR in Crore &amp; FC in Million

Sr.	Name of the Subsidiary Company	Country	Reporting currency	Capital	Reserves	Total Assets	Total Liabilities	Investments Shares, Debiture, Bonds & Others	Turnover/ Revenues	Profit/(Loss) before Tax	Provision for Tax	Gain/Loss from Discontinued Operations	Proposed Dividend	% of Share Holding
32	Novelis AG*	Switzerland	INR	8.23	1,746.40	10,612.43	8,857.79	9,783.46	84.28	0.61	-	-	83.67	100
			CHF	1.00	212.28	1,289.95	1,076.67	1,206.50	10.39	0.08	-	-	10.32	-
33	Novelis Holdings Inc.*	USA	INR	0.00	810.43	11,769.97	10,959.54	-	(325.98)	(62.77)	-	-	(263.21)	100
			USD	0.00	106.76	1,550.52	1,443.76	-	(43.76)	(8.43)	-	-	(35.33)	-
34	8018227 Canada Inc.*	Canada	INR	-	(635.96)	1,925.56	2,561.51	-	108.64	13.48	-	-	95.17	100
			USD	-	(83.78)	253.66	337.44	-	14.58	1.81	-	-	12.78	-
35	Novelis Sheet Ingot GmbH*	Germany	INR	168.12	-	4,964.89	4,796.77	-	857.83	80.39	-	-	80.39	100
			EUR	20.00	-	590.64	570.64	-	99.09	9.29	-	-	9.29	-
36	Novelis MEA Ltd*	UAE, Dubai	INR	6.93	460.81	2,044.75	1,577.01	-	5,539.20	423.71	-	-	423.71	100
			USD	0.91	60.70	269.36	207.75	-	743.58	56.88	-	-	56.88	-
37	Novelis (Shanghai) Aluminum Trading Company*	China	INR	26.51	13.25	58.72	18.97	-	9.73	(0.37)	0.15	-	(0.52)	100
			CNY	22.14	11.07	49.06	15.85	-	8.38	(0.32)	0.13	-	(0.45)	-
38	Novelis (China) Aluminum Products Co., Ltd.*	China	INR	1,014.23	1,150.92	5,252.79	3,087.64	-	3,990.80	697.31	147.50	-	549.81	100
			CNY	847.31	961.50	4,388.30	2,579.48	-	3,438.01	600.72	127.07	-	473.65	-
39	Novelis Vietnam Company Limited*	Vietnam	INR	6.60	18.59	41.31	16.12	-	0.02	(1.80)	-	-	(1.80)	100
			VND	20,820.00	58,688.96	130,403.02	50,894.05	-	73.41	(5,690.22)	-	-	(5,690.22)	-
40	Novelis Services (North America) Inc.*	USA	INR	-	-	0.10	0.10	-	-	-	-	-	-	100
			USD	-	-	0.01	0.01	-	-	-	-	-	-	-
41	Novelis Services (Europe) Inc.*	USA	INR	-	-	2.22	2.22	-	-	-	-	-	-	100
			USD	-	-	0.29	0.29	-	-	-	-	-	-	-
42	Brecha Energetica Ltda*	Brazil	INR	0.00	0.00	0.00	-	-	0.00	-	0.00	-	0.00	100
			BRL	0.00	0.00	0.00	-	-	0.00	-	0.00	-	0.00	-
43	Novelis Global Employment Organization, Inc.*	USA	INR	2.47	(3.37)	41.90	42.80	-	-	(3.02)	(0.36)	-	(2.66)	100
			USD	0.33	(0.44)	5.52	5.64	-	-	(0.40)	(0.05)	-	(0.36)	-
44	Novelis (India) Infotech Ltd.*	India	INR	-	-	-	-	-	-	-	-	-	-	100
			INR	-	-	-	-	-	-	-	-	-	-	-

Figures INR in Crore &amp; FC in Million

Sr.	Name of the Subsidiary Company	Country	Reporting currency	Capital	Reserves	Total Assets	Total Liabilities	Investments Shares, Debiture, Bonds & Others	Turnover/ Revenues	Profit/(Loss) before Tax	Provision for Tax	Gain/Loss from Discontinued Operations	Proposed Dividend	% of Share Holding
45	Novelis Deutschland Holding GmbH*	Germany	INR	4,794.35	(1,328.69)	4,341.14	875.48	-	0.17	0.34	0.34	-	-	100
			EUR	570.35	(158.06)	516.43	104.15	-	0.02	0.04	0.04	-	-	-
46	Novelis Koblenz GmbH*	Germany	INR	819.98	367.95	4,187.33	2,999.39	-	5,649.35	(435.48)	11.15	-	(446.63)	100
			EUR	97.55	43.77	498.14	356.82	-	652.59	(50.31)	1.29	-	(51.59)	-
47	Novelis Casthouse Germany GmbH*	Germany	INR	370.80	0.01	950.58	579.77	-	2,605.47	(21.19)	0.51	-	(21.69)	100
			EUR	44.11	0.00	113.08	68.97	-	300.97	(2.45)	0.06	-	(2.51)	-
48	Novelis ALR Aluminum Holdings Corporation*	USA	INR	9,942.49	54.30	15,978.07	5,981.28	-	-	(138.24)	(338.05)	-	199.82	100
			USD	1,309.77	7.15	2,104.87	787.94	-	-	(18.56)	(45.38)	-	26.82	-
49	Novelis ALR International, Inc.*	USA	INR	18,096.94	(2.44)	22,779.76	4,685.26	-	-	14.22	(9.86)	-	24.08	100
			USD	2,384.00	(0.32)	3,000.89	617.21	-	-	1.91	(1.32)	-	3.23	-
50	Novelis ALR Rolled Products, Inc.*	USA	INR	12,097.07	(1,940.66)	13,290.83	3,134.42	-	4,988.34	(233.78)	(253.46)	28.76	48.44	100
			USD	1,593.61	(255.65)	1,750.87	412.91	-	669.63	(31.38)	(34.02)	3.86	6.50	-
51	Novelis ALR Asset Management Corporation*	USA	INR	8.37	11.84	23.11	2.90	-	-	5.84	(7.12)	-	12.96	100
			USD	1.10	1.56	3.05	0.38	-	-	0.78	(0.96)	-	1.74	-
52	Novelis ALR Rolled Products, LLC*	USA	INR	2,333.56	(443.83)	5,391.81	3,502.09	-	5,263.00	(127.84)	-	0.06	(127.78)	100
			USD	307.41	(58.47)	710.29	461.35	-	706.50	(71.16)	-	0.01	(71.15)	-
53	Novelis ALR Rolled Products Sales Corporation*	USA	INR	0.02	(15.99)	109.17	125.15	-	-	(1.88)	(4.57)	-	2.69	100
			USD	0.00	(2.11)	14.38	16.49	-	-	(0.25)	(0.61)	-	0.36	-
54	Novelis ALR Recycling of Ohio, LLC*	USA	INR	183.88	9.76	851.54	657.90	-	241.94	0.66	-	-	0.66	100
			USD	24.22	1.29	112.18	86.67	-	32.48	0.09	-	-	0.09	-
55	Novelis ALR Aluminum LLC*	USA	INR	1,624.81	1,020.13	3,081.93	436.99	-	3,963.76	667.94	-	-	667.94	100
			USD	214.04	134.39	406.00	57.57	-	532.09	89.66	-	-	89.66	-
56	Novelis ALR Aluminum-Alabama LLC*	USA	INR	2.44	(4.75)	38.81	41.2	-	-	(2.16)	-	-	(2.16)	100
			USD	0.32	(0.63)	5.11	5.42	-	-	(0.29)	-	-	(0.29)	-
57	Aleris Holding Canada ULC*	Canada, Nova Scotia	INR	-	0.03	0.03	-	-	-	-	-	-	-	100
			USD	-	0.00	0.00	-	-	-	-	-	-	-	-

Figures INR in Crore &amp; FC in Million

Sr.	Name of the Subsidiary Company	Country	Reporting currency	Capital	Reserves	Total Assets	Total Liabilities	Investments Shares, Debiture, Bonds & Others	Turnover/ Revenues	Profit/(Loss) before Tax	Provision for Tax	Gain/Loss from Discontinued Operations	Profit/(Loss) after Tax.	Proposed Dividend	% of Share Holding
58	Novelis Netherlands B.V.*	Netherlands	INR	6,437.46	(2,708.19)	4,207.42	4,781.4	-	-	24.66	5.57	(0.66)	18.43	-	100
			EUR	765.82	(322.17)	500.53	56.88	-	-	2.85	0.64	(0.08)	2.13	-	
59	Aleris Switzerland GmbH*	Switzerland	INR	0.16	29.36	122.08	92.55	-	-	(4.52)	-	-	(4.52)	-	100
			CHF	0.02	3.57	14.84	11.25	-	-	(0.56)	-	-	(0.56)	-	
60	Aleris Aluminium UK Limited*	United Kingdom	INR	0.00	0.34	0.72	0.37	-	0.35	(0.27)	-	-	(0.27)	-	100
			GBP	0.00	0.03	0.07	0.04	-	0.03	(0.03)	-	-	(0.03)	-	
61	Aleris Aluminium Japan, Ltd.*	Japan	INR	0.74	1.02	2.13	0.37	-	1.97	0.12	0.08	-	0.04	-	100
			JPY	12.00	16.41	34.41	6.00	-	29.74	1.88	1.24	-	0.64	-	
62	Aleris Asia Pacific International (Barbados) Ltd.*	Barbados	INR	42.28	(21.19)	21.72	0.64	-	-	(0.09)	-	-	(0.09)	-	100
			EUR	5.03	(2.52)	2.58	0.08	-	-	(0.01)	-	-	(0.01)	-	
63	Aleris (Shanghai) Trading Co., Ltd.*	China	INR	52.36	(13.72)	154.59	115.95	-	350.23	3.06	0.88	-	2.18	-	100
			CNY	43.74	(11.46)	129.15	96.87	-	301.72	2.63	0.75	-	1.88	-	
64	Aleris Asia Pacific Limited*	Hong Kong	INR	4,226.43	(1,843.29)	2,397.11	13.97	-	17.99	(30.22)	1.31	-	(31.52)	-	100
			USD	556.77	(242.83)	315.78	1.84	-	2.42	(4.06)	0.18	-	(4.23)	-	
65	Novelis Aluminium (Zhenjiang) Co., Ltd.*	China	INR	3,853.60	(1,901.16)	3,609.52	1,657.09	-	961.70	(29.52)	-	-	(29.52)	-	100
			CNY	3,279.38	(1,588.27)	3,015.47	1,384.37	-	828.49	(25.43)	-	-	(25.43)	-	
66	Hindalco Do Brazil Industria Comercio de Alumina LTDS*	Brazil	INR	-	-	-	-	-	2,807.45	(160.68)	-	-	(161.95)	-	-
			Reals	-	-	-	-	-	200.45	(11.58)	-	-	(11.58)	-	

# Subsidiary of AV Minerals (Netherlands) N.V.

## Subsidiary of AV Metals Inc.

\* Balance sheet items are translated at closing exchange rate and Profit/(Loss) items are translated at average exchange rate.

**List of Subsidiaries merged during FY 21-22**

Aleris Aluminum France S.à.r.l. Merged into Novelis PAE S.A.S.

Novelis Lamines France S.A.S. Merged into Novelis PAE S.A.S.

Aleris RM, Inc. Merged into Novelis ALR International, Inc. (formerly Aleris International, Inc.)

Name Acquisition Co. Merged into Novelis ALR International, Inc. (formerly Aleris International, Inc.)

**List of Subsidiaries Dissolved during FY 21-22**

Aleris Aluminum Denmark ApS Dissolved into Aleris Switzerland GmbH

Aleris Aluminum Poland Sp. z.o.o. Dissolved into Aleris Switzerland GmbH

**List of Subsidiaries sold during FY 21-22**

Saras Micro Devices, Inc. (Novelis sold 90% ownership of entity. Legal entity still exists but investment is not held as a venture/associate. )

From Ccy	To Ccy	Avg spot rate for the year	Closing rate for 31st March 2022
AUD	INR	55.0692	56.8946
BRL	INR	13.9816	15.9659
CAD	INR	59.4266	60.8311
CHF	INR	81.0894	82.2729
CNY	INR	11.6078	11.9724
EUR	INR	86.5690	84.0610
GBP	INR	101.7635	99.7657
JPY	INR	0.6634	0.6243
NOK	INR	8.5851	8.6410
SEK	INR	8.4616	8.0905
SGD	INR	55.2329	56.0329
USD	INR	74.4927	75.9050

From Ccy	To Ccy	Avg spot rate for the year	Closing rate for 31st March 2022
BRL	USD	0.1877	0.2103
CHF	USD	1.0886	1.0839
CNY	USD	0.1558	0.1577
EUR	USD	1.1624	1.1075
GBP	USD	1.3664	1.3144
JPY	USD	0.0089	0.0082
SEK	USD	0.1136	0.1066
SGD	USD	0.7415	0.7382



## Annexure VII

### Part "B" - Statement pursuant to Section 129 (3) of the Companies Act, 2013 related to Associate Companies and Joint Ventures

Sr. no.	Name of Associates / Joint Ventures	Shares of Associate/Joint Ventures held by the company on the year end					Profit/Loss for the year			
		Latest Audited Balance Sheet Date	Number	Amount of investment (Carrying Value) in Associates / Joint Venture (Rs. in crore)	Extent of Holding % attributable	Networth to Shareholding as per latest audited balance sheet (Rs. in Crore)	Considered in consolidation (Rs. in Crore)	Not considered in consolidation	Description of how there is significant influence	Base on why the associate / joint venture is not considered
<b>Associates</b>										
1	Aditya Birla Science and Technology Company Private Limited	31-Mar-22	9,800,000	9.80	49.00	55.76	27.32		Note A	
2	Aditya Birla Renewables Subsidiary Limited	31-Mar-22	6,895,200	6.90	26.00	27.70	7.20		Note A	
3	Aditya Birla Renewable Utkal Limited (ABRUL)	31-Mar-22	1,274,000	1.27	26.00	5.26	1.37		Note A	
4	Aditya Birla Renewable Solar Limited	31-Mar-22	8,307,000	8.31	26.00	33.97	8.83		Note A	
5	Associates of Novelis Inc. @		3,001	2.12	-	(1.48)	0.10			
<b>Joint Ventures</b>										
1	Hydromine Global Minerals (GMBH) Limited	31-Mar-22	66,562	1.37	45.00	0.01	0.00		Note A	
2	MNH Shakti Limited	31-Mar-22	5,265,000	5.27	15.00	41.55	6.23		Note A	
<b>Joint Operations</b>										
1	Mahan Coal Limited	31-Mar-22	32,250,000	10.25	50.00	22.73	11.36		Note A	
2	Tubed Coal Mines Limited	31-Mar-22	15,296,700	0.00	60.00	2.76	1.66		Note A	
3	Joint Operations of Novelis Inc. @		10,041	2,119.55		341.19	118.59			
<b>@ - Associates of Novelis Inc.</b>										
	Deutsche Aluminium Verpackung Recycling GmbH	31-Dec-21	1	1.74	30%	(1.53)	(0.00)		Equity	
	France Aluminum Recyclage SA	31-Dec-21	3,000	0.38	20%	0.05	0.10		Equity	
<b>@ - Joint Operations of Novelis Inc.</b>										
	Aluminium Norf GmbH	31-Dec-21	1	258.06	50%	187.55	45.12		Equity	
	Logan Aluminum Inc.	31-Mar-22	40	0.00	40%	13.90	1.13		Consolidated	
	AluInfra Services SA	31-Dec-20	5,000	24.06	50%	0.52	0.20		Equity	
	Ulsan Aluminum Ltd.	31-Mar-21	5,000	1,837.42	50%	139.22	72.15		Equity	

**Note A** - There is significant influence due to percentage holding of share capital

## Social Report

### Water: Our Eternal Lifeline

*"Water, the life force for humanity, is the absolutely essential building block. It is the central piece for our planet. Recount Leonardo da Vinci, who said, "Water is the driver of nature".*

*Water and decent sanitation are inextricably linked to all development processes. International agencies such as UNICEF, United Nations University, United Nations Sustainable Development Report, among others record that, water scarcity impairs over 40% of the global population and 2.4 billion people do not have access to basic sanitation services. Sadly, every year 300,000 children succumb to water borne diseases. It augurs well that Goal-6 of SDG focuses on clean water and sanitation. It underpins other SDGs as well. Water is the lifeline, any which way.*

*By and large the UNSDGs, viewed in totality are a revolutionary leap, a kind of wakeup call to every nation to pay close attention to people largely from the vulnerable sector and the planet. It has heightened sensitivities across 193 countries. A shot in the arm of the move towards a fair and equitable society, the UNSDGs have an appealing logic.*

*At our Aditya Birla Group, our underlying motto in our CSR engagement has always been to engage, uplift and empower communities, and in doing so perpetually be a force for good and enrich lives. We are heavily invested in healthcare, education, sustainable livelihood and infrastructure development. Water is the pivotal force that propels our projects in business and beyond. It is the most critical resource. Its sustainable management is of immense importance for our business community. So the SDG Goal-6 is of great significance to us.*

*Climate change, dwindling ecosystems, exploitation of natural resources besides pollution, have accelerated the stress on water resources in terms of its availability and quality. While the report spells out all of your Company's CSR engagements, for any progress, availability of water is the most critical factor. Towards building water resilience, our businesses at Aditya Birla Group have taken a comprehensive stepwise approach both inside the location boundaries as well as in the watersheds of our operation. We have put in place our Water Stewardship Policy championed by our Group Chairman, Business Directors/CEOs and other seniors. This aims at protection and conservation of water resources through excellent water management practices and governance systems and is being operationalized through performance targets and roadmaps across our sites.*

*When one thinks of water in the hinterland of India with its rugged pathways, the picture that immediately surfaces in the mind's eye is that of a woman with pitcher on her head, trudging miles on end to fetch it. Today, the scenario is very different. In quite a few of the 9,000 villages that we work in, we have met this arduous task of ensuring water availability for households and farmers. The Government has rightfully given access to water in rural areas, the primacy it deserves. The plan is to provide tap water for all under the 'Har Ghar, Nal Se Jal' scheme. The scheme's dashboard reports that over 5.6 crore homes now have water on tap.*

*An integrated aggressive watershed management programme implemented as part of our CSR engagement has yielded rich dividends as well. Its components include water harvesting structures: construction of check-dams, instituting tube wells, tanks and water reservoirs. Side-by-side rainwater harvesting, including rooftops, reinventing step-wells, lakes (talaos), wells (bowris), soil conservation, refurbishing aquatic ecosystems,*

# Social Report

*setting up reverse osmosis plants and water ATMs, have brought much succour to a water starved populace pan India. Besides the admirable Government support, we partner extensively with development agencies such as NABARD, MYRADA, ICRISAT and AFPRO on the technical side, among others. The water conserved annually is over 33 billion liters, of which your Company has conserved 1.55 billion liters. Water user groups are formed at the plants to make sure that eventually the villagers become self-reliant. There is a sense of joy and lightness among them. Numbers mean a lot, but smiles mean a lot more.*

*In the words of our visionary Prime Minister, "Jal hai toh kal hai".*

**Rajashree Birla**

Chairperson,

*Aditya Birla Centre for Community Initiatives and Rural Development  
Chairperson, Hindalco Industries CSR Board*

A summary of our work:

## **SDG-1: To rid poverty across all nations by 2030**

In the 10 states and one Union Territory, where we operate, we are engaged in enriching the lives of the underprivileged, in multiple ways to decelerate the percentage of BPL families.

## **SDG-2: To end all forms of hunger and malnutrition by 2030**

Through sustainable agriculture, we are helping farmers in multiple ways. These include land clearances, technology upgradation and closing the marketing loop. We also enable them access Government Schemes. Through supporting the District Authorities, including Collectors and Block Development Officers, we are aiming to significantly lowering the current rate of acute malnutrition among children below 5 years to 5% from 8% in the foreseeable future.

## **Water Positivity**

Our chairperson has alluded to ways in which we work to ensure water positivity. We have constructed 12 check dams, excavated 34 ponds, 29 bundings, 8 watershed structures and 18 rainwater harvesting structures. This has enabled us conserve 0.68 million cubic meter of water reaching out to 3,140 farmers.

We have repaired 9 check dams/irrigation channels at Renukoot, Singrauli, Kathautia and Lohardaga. These provide irrigation facility to enhance cash crop production in more than 973.5 hectares of land. The 110 organic farmers in these districts along with others are much encouraged.

## **Agriculture and Farm Based:**

Through 137 farmers training programmes we reached out to 3,390 farmers (Singrauli, Renukoot, Lohardaga Samri, Belagavi and Renusagar) to boost agricultural and horticultural activities. Farmers reap a rich harvest. Over 4,461 households are cultivating vegetables and 102 farmers are growing fruits to supplement their income.

More than 2,274 farmers received agricultural tools, seeds, fertilisers and insecticides during the agriculture support programmes (Renukoot, Renusagar, Maliparbat and Singrauli). Collectively there has been an upswing in their earnings.

We promoted 62 farmers' clubs with 1408 members at Renukoot. This has led to ensure cost optimisation through economics of scale in the procurement of inputs, to realise better margin through collective marketing. We facilitate them access services under different schemes as well as enrich knowledge by exchanging ideas and information.

Our agricultural farmland levelling and trench digging at Renukoot and Lohardaga, benefitted 399 farmers. They were supported with lift and drip irrigation facilities at 39 locations.

Under the social forestry programme, we continue to sponsor distribution of saplings. This year 1,98,140 saplings were given to households in Samri, Renukoot, Renusagar, Belagavi, Singrauli, Lohardaga, Kathautia and Talaja.

Our veterinary camps aided over 9,501 cattle owners. Nearly, 47,506 were immunised in veterinary camps held at our units at Renukoot, Renusagar, Lohardaga, Samri, Belagavi and

Singrauli. Over 420 cattle were artificially inseminated and an additional 1,976 were treated for their illnesses. Consequently, incomes were enhanced significantly as the milk outcome notched up by 70%.

## **SDG-3: Ensuring, healthy lives and promoting well-being for all, in all age groups**

Over 37,299 people recourse to our 675 rural medical and awareness camps. Our rural mobile medical van services complemented these efforts. Those diagnosed with serious ailments were referred to our hospitals for treatment.

More than 44,864 patients were tended to at our 3 hospitals and 15 dispensaries/clinics at Renukoot, & Renusagar (Uttar Pradesh), Belagavi (Karnataka), Muri & Lohardaga (Jharkhand), Samri & Garepalma (Chhattisgarh).

We supported 9 Government/Charity run primary health centres, with medical treatments to 4,115 patients (Kathautia, Maliparbat, Dumri, Garepalma and Chakla).

At our 21 eye camps 1,632 persons were treated. Of these 292 patients at Renukoot and Muri were operated for cataract and intra-ocular lens (IOL) were fitted for their vision. We also distributed spectacles to the needy for better eyesight.

Over 1,637 persons were attended to at Renusagar in a dental check-up camp.

Under the DOT (Directly Observed Treatment) programme for TB, we registered 61 patients at Renukoot, Renusagar and Chakla. Following the regime, these patients were subsequently rendered free of the disease.

In 26 STD/RTI and AIDS awareness camps, conducted at Singrauli, Lohardaga, Kathautia, Samri, Belagavi, Renusagar and Renukoot 2,461 persons took the tests.

Over 2,685 people have availed of 'Jeevan Mitra Sewa Yojana' facilities through our 15 GPS based ambulances at Muri. Additionally, free ambulance services were forked out to 271 emergency cases at Lohardaga and Kathautia.

We facilitated collection of 102 units of blood at 5 blood donation camps, from 277 donors (Renukoot, Garepalma and Chakla).

We organised 23 seasonal disease camps for Malaria and Diarrhoea in the villages at Renukoot and Lohardaga Mines as a preventive care measure. Over 2,000 needy people at Singrauli received mosquito nets.

More than 1,41,975 children were immunised against polio and 35,165 children were administered with BCG, DPT and anti-hepatitis B vaccines across the company's units.

As part of our Safe Motherhood and Child Survival Programme, in tandem with the District Health Department, our 25 Family Welfare Centres reached out to 30,981 expectant mothers and their children at Renukoot, Renusagar, Kathautia, Garepalma and Lohardaga.

Nearly 11,014 women availed of the ante-natal, post-natal care, nutrition, and escort services for institutional delivery accorded by us at Talaja, Renukoot, Singrauli, Belagavi, Kathautia, Samri, Lohardaga, Dumri and Chakla.

Our focused programme on adolescent health care covered 1,028 girls at 32 Govt. Girls High Schools and 7 Kasturba Gandhi Balika Vidyalayas.

Our intensive motivational drive towards responsible family raising led to 54 villagers opting for planned families across Renukoot and Kathautia.

## **SDG-4: Education**

Nearly 896 children enrolled at 17 Balwadis and 4 Non-Formal centres that we back (Renukoot, Lohardaga, Samri and Belagavi).

At 39 Anganwadis 1,672 children are enrolled (Singrauli, Lohardaga, Renusagar, Kathautia, Talaja and Belagavi). Under the Integrated Child Development Scheme (ICDS) at Singrauli 11 malnourished children were nurtured by us on the road to health.

At 9 Aditya Birla Public Schools (Renukoot, Renusagar and Muri), we have 4,621 rural students. Additionally, we have 2,425 students in our 8 Aditya Birla Vidya Mandirs (Renukoot, Lohardaga, Kathautia and Samri).

Through the Sarva Siksha Abhiyan (SSA) programme, 1565 students of 15 primary schools (Lohardaga, Kathautia and Talaja) have received technical support, study materials, school bags and uniforms. School bags, uniforms, sweaters, and educational items were distributed to 10,199 students of 57 schools (Renukoot, Renusagar, Singrauli, Lohardaga, Garepalma, Maliparbat, Belagavi and Talaja).

To encourage excellence, 207 rural students (Singrauli and Renusagar) were accorded scholarships. Among these, 204 students of class XI, of which 103 were girls won the "Mahan Jyoti scholarship" of Rs.1000 each at Singrauli, sponsored by us.



# Social Report

Coaching classes were conducted for 858 students in Mathematics, Science and English.

To reduce dropouts at the secondary level, we provided bus services to 525 girls (Lohardaga, Samri and Garepalma).

'Meet the parent' events were conducted across 5 of our units at Renukoot, Samri, Kathautia, Belagavi, and Chakla.

Our close involvement has motivated 1175 girls to pursue further education at 7 Kasturba Gandhi Vidyalayas (KGBVs) (Renukoot, Lohardaga, Muri, Dumri and Samri). 122 learners evinced keen interest at our 4 adult literacy programmes (Renusagar and Singrauli).

Sports and cultural programmes were held in 20 schools with a record of 1020 active participants.

Our computer literacy programmes delighted, 336 rural students of which 205 were girls from the hinterland (Renusagar and Singrauli).

Three career counselling camps at Renukoot and Lohardaga, saw the active participation of 98 aspiring students. Subsequently, many of them joined technical and vocational training programmes.

Towards bettering the infrastructure, we constructed one school building at Taloja, an additional classroom at Belagavi, and repaired four school buildings (Lohardaga, Belagavi and Taloja).

We constructed five toilet blocks (Singrauli, Samri, Belagavi and Taloja). Drinking water (Singrauli, Lohardaga, Samri, Kathautia, Belagavi, Chakla and Taloja) and furnishing two schools at Taloja, delivered the necessary facilities to the locals.

## SDG-5: Women empowerment and gender equality

In the 1,798 self-help groups totalling 23,038 women, each one of them has been on a transformative journey. Most of the SHGs have been linked with income generation activities at various centres. Women are engaged in tailoring, weaving, knitting, handicrafts, beauty parlour, bamboo basket making, making pickles, spices, papad, vegetable vending, cultivation, small business etc.

**The sixth, seventh and eighth SDGs, center on water and sanitation, reliable, sustainable, modern energy, decent work, and economic growth.**

We have installed 37 hand pumps and facilitated installation of another 66 Government hand pumps, repaired 216 hand

pumps and dug wells. These provide safe drinking water to the surrounding villages. We provide potable water to 39 villages through water tankers and pipelines. This is looked upon as a boon by 50,024 villagers who now have access to safe drinking water.

Five toilets were set up at Renusagar, Singrauli and Samri, besides 224 individual toilets constructed at Renukoot by leveraging Government schemes.

We distributed 105 Solar lanterns/lamps at Renusagar, Mahan and 101 solar streetlights at Renusagar, Samri, Lohardaga and Kathautia. Alongside, we installed 7 solar operated 24X7 drinking water supply at Lohardaga and Renukoot.

We imparted vocational skills training to 962 people at Renusagar, Lohardaga, Muri, Singrauli, Belagavi, Samri, Kathautia and Chakla.

We sponsored 71 youths from Singrauli and Muri for Computer, Electronics & Electricals and Mobile repairing. In addition, 1,444 women from Renusagar, Singrauli, Lohardaga, Muri, Kathautia, Dumri, Belagavi, Chakla and Taloja have mastered tailoring skills to supplement their family income with dignity.

At the Aditya Birla Rural Technology Park, the thrust continued to be on computer literacy, repair of electric and electronic goods, handicrafts, bag making, soft toys, beautician tailoring and knitting, ways to enhance agricultural output, and veterinary science. We trained 708 aspirants this year. Apart from this, 16 programmes of capacity building were orchestrated for 421 participants and veterinary services offered to 272 farmers.

## SDG-9: Build resilient infrastructure

Our infrastructure projects: connectivity, construction and repair of village approach road, culvert, panchayat Bhawan, pond excavation, bathing ghats, bathrooms, protection wall, channel pitching, rural housing, check dams, bus stops, garden etc. on the needs have bettered the lives of 75,369 people.

Of the 620 villages, we operate in, 104 villages have been slated to become model villages. Up until now, 38 villages have made the cut to be rated as model villages. Impact assessment studies by external agencies have certified/commended the transformation of these villages.

Our activities under Social Issues are aligned with **SDG-5 and SDG-10** of 'Gender equality and women empowerment', and "Reduced inequalities".

We support the community through various social initiatives such as advocacy against child labour, illiteracy, child marriages, the marginalisation and abuse of the girl child and women, alcoholism, and poor hygiene among others to bring in social reform through behavioural changes. We have organised 684 camps where 21,399 people have attended.

To spark the creativity in the communities, 319 cultural programmes were held, celebrating national events, besides 75 sports activities.

We distributed 7,369 blankets to the needy at Renukoot, Renusagar, Singrauli, Lohardaga, Muri, Kathautia, Garepalma, Chakla and Samri.

We support 110 residents of 3 orphanages and old age homes at Taloja.

## Accolades/Awards received: (Hindalco and Its Subsidiaries)

### Renukoot

- CSR Health Impact Awards for project "Aarogya".
- ICC Social Impact Awards (2) for their projects- "Unnati" and "Aarogya"

### Aditya Aluminium

- Fame Excellence Award for Women Empowerment (Project SAKSHAM).

### Mahan, Singrauli

- CSR TIMES AWARDS 2021 for "Water Conservation & Management".

## Utkal Alumina:

- Baphimali Bauxite Mines received Sita Ram Rungta Award for Social Responsibility
- Odisha CSR Forum Award for outstanding contribution in the field of corporate social responsibility & community development initiative.

## Mines Division Lohardaga

- "Fame Excellence Award 2020-21" for excellence in best CSR Practices.

## Hindalco, Hirakud

- Brands of Odisha. Pride of India.: Sambad, Corporate Excellence Awards - 2022.

## Our CSR spends:

This year we have invested Rs.37.54 crore (3.11% of our net profit) and raised Rs.65.75 crore, leveraging the Government's development programmes. In addition, our subsidiaries have spent ₹ 17.49 crores on CSR activities.

We owe big time to our chairman, a big thank you, and Chairperson for always encouraging and motivating us to do better than the best. A big thank you to the Board of Directors, our Management, leadership teams, our CSR people and each and every colleague from Hindalco for always cheering our CSR engagements, geared towards enriching the lives of 12 lakhs of our fellow Indians in 620 villages across 10 states and 1 Union Territory.

# BRSR Indicator

BRSR INDICATOR NO.	DISCLOSURE	REFERENCE SECTION/ PAGE NUMBER
<b>SECTION A: GENERAL DISCLOSURES</b>		
1	Corporate Identity Number (CIN) of the Listed Entity	L27020MH1958PLC011238
2	Name of the Listed Entity	Hindalco Industries Limited
3	Year of incorporation	1958
4	Registered office address	Ahura Centre, B wing , 1 <sup>st</sup> Floor, Mahakali Caves Road, Andheri East, Mumbai 400093
5	Corporate address	Same as above
6	E-mail	anil.malik@adityabirla.com
7	Telephone	022-66626666
8	Website	www.hindalco.com
9	Financial year for which reporting is being done	Financial Year 2021-2022
10	Name of the Stock Exchange(s) where shares are listed	BSE Limited , National Stock Exchange of India Limited and Luxembourg Stock Exchange (GDR)
11	Paid-up Capital	As on 31 <sup>st</sup> March, 2021 Rs. 2,24,71,72,724
12	Name and contact details (telephone, email address) of the person who may be contacted in case of any queries on the BRSR report	Mr. Anil Malik, Company Secretary Tel: 022-66626666 E mail id :anil.malik@adityabirla.com
13	Reporting boundary - Are the disclosures under this report made on a standalone basis (i.e., only for the entity) or on a consolidated basis (i.e., for the entity and all the entities which form a part of its consolidated financial statements, taken together).	Consolidated basis
<b>II. Products/ Services</b>		
14	Details of business activities (accounting for 90% of the turnover):	About Hindalco section
15	Products/Services sold by the entity (accounting for 90% of the entity's Turnover)	About Hindalco section
<b>III. Operations</b>		
16	Number of locations where plants and/or operations/ offices of the entity are situated (National and International)	About Hindalco section- Map of locations available
17	Markets served by the entity:	About Hindalco
17a	Number of locations	50 locations including Hindalco India and Novelis manufacturing locations.
17b	What is the contribution of exports as a percentage of the total turnover of the entity?	51% revenue from exports for Indian ops. Exports to S. Korea, malaysia, Taiwan, Thailand, USA, Brazil and Japan.

BRSR INDICATOR NO.	DISCLOSURE	REFERENCE SECTION/ PAGE NUMBER
17c	A brief on types of customers	About Hindalco
<b>IV. Employees</b>		
18a	Employees and workers (including differently abled):	Employee strength- Human Capital
18b	Differently abled Employees and workers:	13 differently abled workers
19	Participation/Inclusion/Representation of women	Employee strength- Human Capital
20	Turnover rate for permanent employees and workers(Disclose trends for the past 3 years)	Employee turnover rate- Human Capital
<b>V. Holding, Subsidiary and Associate Companies (including joint ventures)</b>		
21a	Names of holding / subsidiary / associate companies / joint ventures	As per Annexure 1
<b>VI. CSR Details</b>		
22(i)	Whether CSR is applicable as per section 135 of Companies Act, 2013	Yes
22(ii)	Turnover (in ₹)	₹ 1,95,059 crores
22(iii)	Net worth (in ₹)	₹ 78,189 crores
<b>VII. Transparency and Disclosures Compliances</b>		
23	Complaints/Grievances on any of the principles (Principles 1 to 9) under the National Guidelines on Responsible Business Conduct:	Customer Satisfaction- Social and Relationship Capital Diversity and Inclusion- Human Capital
24	Overview of the entity's material responsible business conduct issues	Materiality Assessment Risk Management- Building resilience
<b>1 Policy and management processes</b>		
	1. a. Whether your entity's policy/ policies cover each principle and its core elements of the NGRBCs. (Yes/No)^	Yes
	P1 Businesses should conduct and govern themselves with integrity in a manner that is real, transparent, and accountable	Code of conduct
	P2 Businesses should provide goods and services in a manner that is sustainable and safe	Sustainability Policy
	P3 Businesses should respect and promote the well-being of all employees, including those in their value chains	Safety and Occupational Health Policy
	P4 Businesses should respect the interests of and be responsive towards all its stakeholders	Corporate Social Responsibility Policy
	P5 Businesses should respect and promote human rights	Human Rights Policy



## BRSR Indicator

BRSR INDICATOR NO.	DISCLOSURE	REFERENCE SECTION/ PAGE NUMBER
P6	Businesses should respect, protect, and make efforts to restore the environment	Environment Policy
P7	Businesses when engaging in influencing public and regulatory policy, should do so in a manner that is responsible and transparent	Code of conduct
P8	Businesses should promote inclusive growth and equitable development	Rehabilitation and resettlement policy Corporate Social Responsibility Policy
P9	Businesses should engage with and provide value to their consumers in a responsible manner	Code of conduct
b.	Has the policy been approved by the Board?	Yes
c.	Web Link of the Policies, if available	<a href="https://www.hindalco.com/investor-centre/policies">https://www.hindalco.com/investor-centre/policies</a> (Some policies may also include a combination of internal policies of the Corporation which are accessible to all internal stakeholders and policies placed on the Corporation's website)
2.	Whether the entity has translated the policy into procedures. (Yes / No)	Yes (As applicable)
3.	Do the enlisted policies extend to your value chain partners? (Yes/No)	Yes (As applicable)
4.	Name of the national and international codes/certifications/labels/ standards (e.g., Forest Stewardship Council, Fairtrade, Rainforest Alliance, Trustea) standards (e.g., SA 8000, OHSAS, ISO, BIS) adopted by your entity and mapped to each principle	Reinforcing Operational Excellence- Manufactured Capital
5.	Specific commitments, goals and targets set by the entity with defined timelines, if any.	Please refer to Human Capital, Natural Capital, and Social and Relationship Capital
6.	Performance of the entity against the specific commitments, goals and targets along-with reasons in case the same are not met.	Please refer to Human Capital, Natural Capital, and Social and Relationship Capital
2.	Governance, leadership and oversight	
7.	Statement by director responsible for the business responsibility report, highlighting ESG related challenges, targets, and achievements (listed entity has flexibility regarding the placement of this disclosure)	Message from the Managing Director

BRSR INDICATOR NO.	DISCLOSURE	REFERENCE SECTION/ PAGE NUMBER
8.	Details of the highest authority responsible for implementation and oversight of the Business Responsibility policy (Yes).	Risk Management and ESG Committee.
9.	Does the entity have a specified Committee of the Board/ Director responsible for decision making on sustainability related issues? (Yes / No). If yes, provide details.	Environment Management at Hindalco- Natural Capital
10.	Details of Review of the National Guidelines on Responsible Business Conduct (NGRBC)	-
11.	Has the entity carried out independent assessment/ evaluation of the working of its policies by an external agency? (Yes/No). If yes, provide name of the agency.	No
12.	If answer to question (1) above is "No" i.e., not all Principles are covered by a policy, reasons to be stated:	NA

### SECTION C: PRINCIPLE WISE PERFORMANCE DISCLOSURE

#### Principle 1

##### Essential Indicators

1	Percentage coverage by training and awareness programmes on any of the Principles during the financial year	
	Board of Directors/ Key Managerial Personnel (KMP)	Refer Corporate Governance part of Integrated Annual Report
	Employees other than Board of Directors or KMPs	Human Capital Development- Human Capital
	Workers	Human Capital Development- Human Capital
2	Details of fines / penalties /punishment/award/ compounding fees/ settlement amount paid in proceedings	Environmental management- Natural Capital
3	Of the instances disclosed in Question 2 above, details of the Appeal/ Revision preferred in cases where monetary or non-monetary action has been appealed.	Environmental management- Natural Capital
4	Details of complaints with regard to conflict of interest	-NIL
5	Number of Directors/KMPs/employees/ workers against whom disciplinary action was taken by any law enforcement agency for the charges of bribery/ corruption	-Nil

## BRSR Indicator

BRSR INDICATOR NO.	DISCLOSURE	REFERENCE SECTION/ PAGE NUMBER
6	Details of anti-corruption or anti-bribery policy.	Code of conduct
7	Details of any corrective action taken or underway on issues related to fines / penalties / action taken by regulators/ law enforcement agencies/ judicial institutions, on cases of corruption and conflicts of interest	None
<b>Leadership Indicators</b>		
1	Awareness programmes conducted for value chain partners on any of the principles during the financial year:	Supplier Evaluation and Risk Assessment- Social and Relationship Capital
	Percentage coverage by awareness programmes on any or all the principles in the financial year:	NA
2	Process in place to avoid/ manage conflict of interests involving members of the Board	Code of conduct of the Board of Directors
<b>Principle 2</b>		
<b>Essential Indicators</b>		
1	Percentage of R&D and capital expenditure (capex) investments in specific technologies to improve the environmental and social impacts of product and processes to total R&D and capex investments made by the entity, respectively.	Highlights- Intellectual Capital
2(a)	Does the entity have procedures in place for sustainable sourcing?	Supplier code of conduct.Integrating ESG in Supply Chain Management- Social and Relationship Capital
2(b)	If yes, what percentage of inputs were sourced sustainably?	Supplier Evaluation and Risk Assessment- Social and Relationship Capital
3	Describe the processes in place to safely reclaim your products for reusing, recycling, and disposing at the end of life, for (a) Plastics (including packaging) (b) E-waste (c) Hazardous waste and (d) other waste.	Waste as a Resource- Natural Capital
4	Whether Extended Producer Responsibility (EPR) is applicable to the entity's activities (Yes / No). If yes, whether the waste collection plan is in line with the Extended Producer Responsibility (EPR) plan submitted to Pollution Control Boards? If not, provide steps taken to address the same.	Non-Hazardous Waste- Natural Capital
<b>Leadership Indicators</b>		
1	Life Cycle Perspective / Assessments (LCA) for any of its products (for manufacturing industry) or for its services (for service industry)	Delivering High Quality- Intellectual Capital

BRSR INDICATOR NO.	DISCLOSURE	REFERENCE SECTION/ PAGE NUMBER
2	Significant social or environmental concerns and/ or risks arising from production or disposal of your products / services, as identified in the Life Cycle Perspective / Assessments (LCA) or through any other means.	Delivering High Quality- Intellectual Capital
3	Percentage of recycled or reused input material to total material (by value) used in production (for manufacturing industry) or providing services (for service industry).	Maximizing Circularity- Natural Capital
4	Of the products and packaging reclaimed at end of life of products, amount (in metric tonnes) reused, recycled, and safely disposed	Waste as a resource- Natural Capital
5	Reclaimed products and their packaging materials (as percentage of products sold) for each product category.	Not reported
<b>Principle 3</b>		
<b>Essential Indicators</b>		
1. a.	Details of measures for the well-being of employees	Employee Wellbeing and Human Rights- Human Capital
b.	Details of measures for the well-being of workers	Employee Wellbeing and Human Rights- Human Capital
2.	Details of retirement benefits, for Current FY and Previous Financial Year.	Employee Wellbeing and Human Rights- Human Capital
3	Accessibility of workplaces	Employee benefits- Profit and Loss Statement
4.	Does the entity have an equal opportunity policy as per the Rights of Persons with Disabilities Act, 2016? If so, provide a web-link to the policy.	Human Rights PolicyCode of conduct
5.	Return to work and Retention rates of permanent employees and workers that took parental leave.	Employee well-being and Human Rights- Human Capital
6.	Greivance Redressal mechanism for employees	Whistleblower Policy
7.	Membership of employees and worker in association(s) or Unions recognised by the listed entity	Employee wellbeing and Human rights- human capital
8.	Details of training given to employees and workers:	Human capital development- Huma capital Safety Training- Human Capital
9.	Details of performance and career development reviews of employees and worker:	Performance evaluation- Human Capital
10.	Occupational health and safety management system implemented by the entity	ISO 45001, Occupational Health and Safety- Human Capital
10(a)	Whether an occupational health and safety management system has been implemented by the entity? (Yes/ No). If yes, the coverage such system?	Reinforcing Operational Excellence- Manufactured Capital



## BRSR Indicator

BRSR INDICATOR NO.	DISCLOSURE	REFERENCE SECTION/ PAGE NUMBER
10(b)	What are the processes used to identify work-related hazards and assess risks on a routine and non-routine basis by the entity?	Safety Risk Assessment- Human Capital
10(c)	Whether you have processes for workers to report the work- related hazards and to remove themselves from such risks. (Y/N)	Yes
10(d)	Do the employees/ worker of the entity have access to non-occupational medical and healthcare services? (Yes/ No)	Yes; Employee well-being and Human Rights- Human Capital
11.	Details of safety related incidents	Safety trainings- Human Capital
12	Describe the measures taken by the entity to ensure a safe and healthy workplace.	Safety trainings- Human Capital
13	Number of health and safety related complaints	NIL
14	Assessments for the year:	Safety Risk Assessment- Human Capital
15	Provide details of any corrective action taken or underway to address safety-related incidents (if any) and on significant risks / concerns arising from assessments of health and safety practices and working conditions.	Occupational Health and Safety- Human Capital
1.	Life insurance or any compensatory package in the event of death of employees and workers	Life insurance coverage provided. Benefits on case to case basis and as per applicable local law.
2	Measures undertaken by the entity to ensure that statutory dues have been deducted and deposited by the value chain partners.	We have a system to track the information available in the public domain.
3	Number of employees / workers having suffered high consequence work- related injury / ill-health / fatalities, who have been are rehabilitated and placed in suitable employment or whose family members have been placed in suitable employment:	We provide livelihood assistance on case to case basis.
4	Does the entity provide transition assistance programs to facilitate continued employability and the management of career endings resulting from retirement or termination of employment? (Yes/ No)	Yes, Employee wellbeing- Human capital
5	Details on assessment of value chain partners:	Supplier Evaluation and Risk Assessment- Social and Relationship Capital

BRSR INDICATOR NO.	DISCLOSURE	REFERENCE SECTION/ PAGE NUMBER
6	Provide details of any corrective actions taken or underway to address significant risks / concerns arising from assessments of health and safety practices and working conditions of value chain partners.	Supplier Evaluation and Risk Assessment- Social and Relationship Capital
<b>Principle 4</b>		
<b>Essential Indicators</b>		
1	Describe the processes for identifying key stakeholder groups of the entity.	Stakeholder Engagement
2	List stakeholder groups identified as key for your entity and the frequency of engagement with each stakeholder group.	Stakeholder Engagement
<b>Leadership Indicators</b>		
1	Provide the processes for consultation between stakeholders and the Board on economic, environmental, and social topics or if consultation is delegated, how is feedback from such consultations provided to the Board.	Stakeholder Engagement
2	Whether stakeholder consultation is used to support the identification and management of environmental, and social topics (Yes / No). If so, provide details of instances as to how the inputs received from stakeholders on these topics were incorporated into policies and activities of the entity.	Stakeholder Engagement
3	Provide details of instances of engagement with, and actions taken to, address the concerns of vulnerable/ marginalized stakeholder groups.	CSR Strategy
<b>Principle 5</b>		
<b>Essential Indicators</b>		
1	Employees and workers who have been provided training on human rights issues and policy(ies) of the entity, in the following format	protecting our employees and workers- Human Capital
2	Details of minimum wages paid to employees and workers, in the format	Employee wellbeing- Human capital
3	Details of remuneration/salary/wages in prescribed format	Corporate Governance
4	Focal point (Individual/ Committee) responsible for addressing human rights impacts or issues caused or contributed to by the business	Protecting our employees and workers- Human Capital

## BRSR Indicator

BRSR INDICATOR NO.	DISCLOSURE	REFERENCE SECTION/ PAGE NUMBER
5	Internal mechanisms in place to redress grievances related to human rights issues.	Whistleblower policy
6	Number of Complaints on the following made by employees and workers: Sexual Harassment Discrimination at work place Child Labour Forced Labour/Involuntary Labour Wages Other human rights related issues	Diversity and Inclusion- Human Capital
7	Mechanisms to prevent adverse consequences to the complainant in discrimination and harassment cases.	POSH policy
8	Do human rights requirements form part of your business agreements and contracts? (Yes/No)	Protecting our employees and workers- Human Capital
9	Assessments on: Child labour Forced/involuntary labour Sexual harassment Discrimination at workplace Wages Others – please specify	100%
10	Provide details of any corrective actions taken or underway to address significant risks / concerns arising from the assessments at Question 9 above	POSH and Values violation cases were observed. Investigations have been conducted and action taken.
<b>Leadership Indicators</b>		
1	Details of a business process being modified / introduced as a result of addressing human rights grievances/complaints.	NA
2	Details of the scope and coverage of any Human rights due diligence conducted.	100% internal operations and selected high volume suppliers.
3	Is the premise/office of the entity accessible to differently abled visitors, as per the requirements of the Rights of Persons with Disabilities Act, 2016?	Yes
4	Details on assessment of value chain partners:	Supplier Evaluation and Risk Assessment- Social and Relationship Capital
5	Provide details of any corrective actions taken or underway to address significant risks / concerns arising from the assessments at Question 4 above.	
<b>Principle 6</b>		
<b>Essential Indicators</b>		
1	Total energy consumption (in Joules or multiples) and energy intensity Note: Indicate if any independent assessment/ evaluation/assurance has been carried out by an external agency? (Y/N) If yes, name of the external agency	Energy Consumption- Natural Capital
2	Sites / facilities identified as designated consumers (DCs) under the Performance, Achieve and Trade (PAT) Scheme of the Government of India.	Energy and GHG- Natural Capital

BRSR INDICATOR NO.	DISCLOSURE	REFERENCE SECTION/ PAGE NUMBER
3	Details of disclosures related to water Note: Indicate if any independent assessment/ evaluation/assurance has been carried out by an external agency? (Y/N) If yes, name of the external agency	Water Withdrawal- Natural Capital
4	Has the entity implemented a mechanism for Zero Liquid Discharge? If yes, provide details of its coverage and implementation.	Securing water- Natural Capital <b>100% coverage</b>
5	Details of air emissions (other than GHG emissions) by the entity.	Stack emissions- Natural Capital
6	Details of greenhouse gas emissions (Scope 1 and Scope 2 emissions) & its intensity	Emissions Management- Natural Capital
7	Project related to reducing Green House Gas emission? If yes, then provide details.	Initiatives for Energy and Emission Reduction- Natural Capital
8	Details of Waste management practices	Waste as a resource- Natural Capital
9	Briefly describe the waste management practices adopted in your establishments. Describe the strategy adopted by your company to reduce usage of hazardous and toxic chemicals in your products and processes and the practices adopted to manage such wastes.	Waste as a resource- Natural Capital
10	Details of environmental approvals / clearances	Environment Management- Natural Capital
11	Details of environmental impact assessments of projects undertaken by the entity based on applicable laws, in the current financial year:	Environment Management- Natural Capital
12	Compliance with applicable environmental law/ regulations/ guidelines in India.	Environment Policy/Environment Management- Natural Capital
<b>Leadership Indicators</b>		
1	Provide break-up of the total energy consumed (in Joules or multiples) from renewable and non-renewable sources.	Energy Consumption- Natural Capital
2	Provide the details related to water discharged:	108-109 (Effluent Management- Natural Capital)
3	Water withdrawal, consumption and discharge in areas of water stress (in kilolitres):  For each facility / plant located in areas of water stress, provide details (i) Name of the area (ii) Nature of operations	Water management- Natural capital  - Water management- Natural capital Water management- Natural capital



## BRSR Indicator

BRSR INDICATOR NO.	DISCLOSURE	REFERENCE SECTION/ PAGE NUMBER
4	Please provide details of total Scope 3 emissions & its intensity, in the following format:	Emission Management- Natural Capital
5	With respect to the ecologically sensitive areas reported at Question 10 of Essential Indicators above, provide details of significant direct & indirect impact of the entity on biodiversity in such areas along-with prevention and remediation activities.	Sustainable Mining- Natural Capital
6	If the entity has undertaken any specific initiatives or used innovative technology or solutions to improve resource efficiency, or reduce impact due to emissions / effluent discharge / waste generated, please provide details of the same as well as outcome of such initiatives, as per the following format:	Waste as a resource- Natural Capital
7	Does the entity have a business continuity and disaster management plan? Give details in 100 words/ web link.	Building Resilience- Strategic priorities and Risk Management
8	Disclose any significant adverse impact to the environment, arising from the value chain of the entity. What mitigation or adaptation measures have been taken by the entity in this regard.	Environment Management- Natural capital
9	Percentage of value chain partners (by value of business done with such partners) that were assessed for environmental impacts.	Supplier Evaluation and Risk Assessment- Social and Relationship Capital
<b>Principle 7</b>		
<b>Essential Indicators</b>		
1(a)	Number of affiliations with trade and industry chambers/ associations.	Our key associations- Business at a glance
1(b)	List the top 10 trade and industry chambers/ associations (determined based on the total members of such body) the entity is a member of/ affiliated to.	Our key associations- Business at a glance
2	Provide details of corrective action taken or underway on any issues related to anti-competitive conduct by the entity, based on adverse orders from regulatory authorities.	No cases
<b>Leadership Indicators</b>		
1	Details of public policy positions advocated by the entity:	NA
<b>Principal 8</b>		
<b>Essential Indicators</b>		
1	Details of Social Impact Assessments (SIA) of projects undertaken by the entity based on applicable laws, in the current financial year.	-NA

BRSR INDICATOR NO.	DISCLOSURE	REFERENCE SECTION/ PAGE NUMBER
2	Information on project(s) for which ongoing Rehabilitation and Resettlement (R&R) is being undertaken by your entity, in the following format:	-NA
3	Mechanisms to receive and redress grievances of the community.	Indigenous and Rehabilitation and Resettlement policy
4	Percentage of input material (inputs to total inputs by value) sourced from suppliers:Directly sourced from MSMEs/ small producers Sourced directly from within the district and neighboring districts	-
<b>Leadership Indicators</b>		
1	Details of actions taken to mitigate any negative social impacts identified in the Social Impact Assessments (Reference: Question 1 of Essential Indicators above):	-NIL
2	Provide the following information on CSR projects undertaken by your entity in designated aspirational districts as identified by government bodies:	Shared in CSR template
3(a)	Do you have a preferential procurement policy where you give preference to purchase from suppliers comprising marginalized /vulnerable groups? (Yes/No)	-No
3(b)	From which marginalized /vulnerable groups do you procure?	-
3(c)	What percentage of total procurement (by value) does it constitute?	-
4	Details of the benefits derived and shared from the intellectual properties owned or acquired by your entity (in the current financial year), based on traditional knowledge:	-
5	Details of corrective actions taken or underway, based on any adverse order in intellectual property related disputes wherein usage of traditional knowledge is involved.	-
6	Details of beneficiaries of CSR Projects:	Shared in CSR template
<b>Principle 9</b>		
<b>Essential Indicators</b>		
1	Describe the mechanisms in place to receive and respond to consumer complaints and feedback.	Customer Satisfaction- Social and Relationship Capital
2	Turnover of products and/ services as a percentage of turnover from all products/service that carry information about:	-NA. We are a base metal company.

## BRSR Indicator

BRSR INDICATOR NO.	DISCLOSURE	REFERENCE SECTION/ PAGE NUMBER
3	Number of consumer complaints in respect of the following: Data privacy Advertising Cyber-security Delivery of essential services Restrictive Trade Practices Unfair Trade Practices Other	-
4	Details of instances of product recalls on account of safety issues: Voluntary recalls, forced recalls	-NIL
5	Does the entity have a framework/ policy on cyber security and risks related to data privacy? <b>(Yes/No)</b> If available, provide a web-link of the policy.	Information Security Policy <a href="https://www.hindalco.com/upload/pdf/information-security-policy.pdf">https://www.hindalco.com/upload/pdf/information-security-policy.pdf</a>
6	Provide details of any corrective actions taken or underway on issues relating to advertising, and delivery of essential services; cyber security and data privacy of customers; re-occurrence of instances of product recalls; penalty / action taken by regulatory authorities on safety of products / services.	NA
<b>Leadership Indicators</b>		
1	Channels / platforms where information on products and services of the entity can be accessed (provide web link, if available).	<a href="https://www.hindalco.com/">https://www.hindalco.com/</a>
2	Steps taken to inform and educate consumers about safe and responsible usage of products and/or services.	-NA
3	Mechanisms in place to inform consumers of any risk of disruption/discontinuation of essential services.	-NA
4	Does the entity display product information on the product over and above what is mandated as per local laws? (Yes/No/Not Applicable) If yes, provide details in brief. Did your entity carry out any survey with regard to consumer satisfaction relating to the major products / services of the entity, significant locations of operation of the entity or the entity as a whole? (Yes/No)	129-130 (Customer Satisfaction- Social and Relationship Capital) 130 (Product Safety and Quality- Social and Relationship Capital)
5	Provide the following information relating to data breaches:	129-130 (Customer Satisfaction- Social and Relationship Capital)
5(a)	Number of instances of data breaches along-with impact	129-130 (Customer Satisfaction- Social and Relationship Capital)
5(b)	Percentage of data breaches involving personally identifiable information of customers	129-130 (Customer Satisfaction- Social and Relationship Capital)

## Annexure I

Sr. No.	Name of the Holding/Subsidiary/ Associate/Joint Venture	Indicate whether Holdings/ Subsidiary/ Associate/ Joint Venture	% Shareholding as on 31.03.2022	Does the Entity indicated at Column A, participate in the Business Responsibility initiatives of the listed entity? (Yes/No)
1.	Utkal Alumina International Limited	Subsidiary	100	NO
2.	Minerals & Minerals Limited	Subsidiary	100	NO
3.	AV Minerals (Netherlands) N.V.	Subsidiary	100	NO
4.	Dahej Harbour & Infrastructure Limited	Subsidiary	100	NO
5.	Hindalco Almex Aerospace Limited	Subsidiary	97.18	NO
6.	East Coast Bauxite Mining Company	Subsidiary	74	NO
7.	Renuka Investments & Finance Limited	Subsidiary	100	NO
8.	Renukeshwar Investments & Finance Limited	Subsidiary	100	NO
9.	Lucknow Finance Company Limited	Subsidiary	100	NO
10.	Suvas Holdings Limited	Subsidiary	74	NO
11.	Hindalco Jan Seva Trust	Subsidiary	100	NO
12.	Copper Jan Seva Trust	Subsidiary	100	NO
13.	Utkal Alumina Jan Seva Trust	Subsidiary	100	NO
14.	Utkal Alumina Social Welfare Foundation	Subsidiary	100	NO
15.	Kosala Livelihood and Social Foundation	Subsidiary	100	NO
16.	A V Metal Inc.	Subsidiary	100	NO
17.	Birla Copper Asoj Private Limited	Subsidiary	100	NO
18.	Novelis Inc.	Subsidiary	100	Novelis follows Business Responsibility as per GRI initiatives
19.	Novelis do Brasil Ltda	Subsidiary	100	
20.	Brecha Energetica Ltda	Subsidiary	99.99	
21.	4260848 Canada Inc.	Subsidiary	100	
22.	4260856 Canada Inc.	Subsidiary	100	
23.	8018227 Canada Inc.	Subsidiary	100	
24.	Novelis (China) Aluminum Products Co. Ltd.	Subsidiary	100	
25.	Novelis (Shanghai) Aluminum Trading Company	Subsidiary	100	
26.	Novelis PAE S.A.S.	Subsidiary	100	
27.	Novelis Aluminum Beteiligungs GmbH	Subsidiary	100	
28.	Novelis Deutschland GmbH	Subsidiary	100	
29.	Novelis Sheet Ingot GmbH	Subsidiary	100	

These are the subsidiaries of Novelis Inc. They follow Business Responsibility as per GRI initiatives.



## Annexure I

Sr. No.	Name of the Holding/Subsidiary/ Associate/Joint Venture	Indicate whether Holdings/ Subsidiary/ Associate/ Joint Venture	% Shareholding as on 31.03.2022	Does the Entity indicated at Column A, participate in the Business Responsibility initiatives of the listed entity? (Yes/No)
30.	Novelis (India) Infotech Ltd.	Subsidiary	100	
31.	Novelis Aluminum Holding Unlimited Company	Subsidiary	100	
32.	Novelis Italia SpA	Subsidiary	100	
33.	Novelis de Mexico S.A. de C.V.	Subsidiary	100	
34.	Novelis Korea Limited	Subsidiary	100	
35.	Novelis AG	Subsidiary	100	
36.	Novelis Switzerland S.A.	Subsidiary	100	
37.	Novelis MEA Ltd.	Subsidiary	100	
38.	Novelis Europe Holdings Limited	Subsidiary	100	
39.	Novelis UK Ltd.	Subsidiary	100	
40.	Novelis Services Limited	Subsidiary	100	
41.	Novelis Corporation	Subsidiary	100	
42.	Novelis South America Holdings LLC	Subsidiary	100	
43.	Novelis Holdings Inc.	Subsidiary	100	
44.	Novelis Services (North America) Inc.	Subsidiary	100	
45.	Novelis Global Employment Organization, Inc.	Subsidiary	100	
46.	Novelis Services (Europe) Inc.	Subsidiary	100	
47.	Novelis Vietnam Company Limited	Subsidiary	100	
48.	Aleris Asia Pacific International (Barbados) Ltd.	Subsidiary	100	
49.	Aleris Aluminum (Zhenjiang) Co., Ltd.	Subsidiary	100	
50.	Aleris (Shanghai) Trading Co., Ltd.	Subsidiary	100	
51.	Aleris Asia Pacific Limited	Subsidiary	100	
52.	Aleris Aluminum Japan, Ltd.	Subsidiary	100	
53.	Novelis Casthouse Germany GmbH	Subsidiary	100	
54.	Aleris Deutschland Holding GmbH	Subsidiary	100	
55.	Novelis Koblenz GmbH	Subsidiary	100	
56.	Novelis Netherlands B.V.	Subsidiary	100	
57.	Aleris Switzerland GmbH	Subsidiary	100	
58.	Aleris Aluminum UK Limited	Subsidiary	100	
59.	Aleris Holding Canada ULC	Subsidiary	100	

These are the subsidiaries of Novelis Inc. They follow Business Responsibility as per GRI initiatives.

Sr. No.	Name of the Holding/Subsidiary/ Associate/Joint Venture	Indicate whether Holdings/ Subsidiary/ Associate/ Joint Venture	% Shareholding as on 31.03.2022	Does the Entity indicated at Column A, participate in the Business Responsibility initiatives of the listed entity? (Yes/No)
60.	Novelis ALR Aluminium Holdings Corporation	Subsidiary	100	
61.	Novelis ALR International Inc.	Subsidiary	100	
62.	Novelis ALR Rolled Products, LLC	Subsidiary	100	
63.	Novelis ALR Rolled Products, Inc.	Subsidiary	100	
64.	Nichols ALR Aluminum LLC	Subsidiary	100	
65.	Novelis ALR Rolled Products Sales Corporation	Subsidiary	100	
66.	Novelis ALR Recycling of Ohio, LLC	Subsidiary	100	
67.	Novelis ALR Aluminum-Alabama LLC	Subsidiary	100	
68.	Novelis ALR Asset Management Corporation	Subsidiary	100	
69.	MNH Shakti Limited	Joint Ventures	15	NO
70.	Hydromine Global Minerals (GMBH) Limited	Joint Ventures	45	NO
71.	Aditya Birla Science & Technology Company Private Limited	Associates	49	NO
72.	Aditya Birla Renewables Subsidiary Limited	Associates	26	NO
73.	Aditya Birla Renewables Utkal Limited	Associates	26	NO
74.	Aditya Birla Renewables Solar Limited	Associates	26	NO
75.	Deutsche Aluminum Verpackung Recycling GMBH	Associates	30	NO
76.	France Aluminum Recyclage SPA	Associates	20	NO

These are the subsidiaries of Novelis Inc. They follow Business Responsibility as per GRI initiatives

# Corporate Governance Report

## Governance Philosophy

The Aditya Birla Group is committed to the adoption of best governance practices and its adherence in the true spirit, at all times. Our governance practices are a product of self-desire reflecting the culture of the trusteeship i.e., deeply ingrained in our value system and reflected in our strategic thought process. At a macro level, our governance philosophy rests on five basic tenets viz., Board accountability to the Company and the shareholders, strategic guidance and effective monitoring by the Board, protection of minority interests and rights, equitable treatment of all shareholders as well as superior transparency and timely disclosures.

In line with this philosophy, Hindalco Industries Limited (the Company), flagship Company of the Aditya Birla Group, is striving for excellence through adoption of best governance and disclosure practices. The Company, as a continuous process, strengthens the quality of disclosures, on the Board composition and its functioning, remunerations paid and level of compliance with various Corporate Governance Codes.

### Compliance with Corporate Governance Guidelines

The Company is fully compliant with the requirements under Securities and Exchange Board of India (Listing Obligations & Disclosure Requirements) Regulations 2015, and amendment thereto hereinafter referred to the "Listing Regulations". Your

Company's compliance with these requirements is presented in the subsequent sections of this report.

### Board of Directors

#### Composition of the Board

Your Company's Board comprises of 9 Non-Executive Directors as on March 31, 2022 with considerable experience in their respective fields. Of these, 6 Directors are Independent Directors of which 1 includes a woman director.

None of the Directors on the Board is a Member of more than 10 Committees or a Chairman of more than 5 Committees (as specified in Regulation 26 of Listing Regulations), across all the Companies in which they hold Directorships. Further, none of the Non-Executive Directors serve as Independent Directors in more than 7 listed companies and none of the Executive or Whole-time Directors serve as Independent Directors on any listed Company. All the Directors have periodically intimated about their Directorship and Membership in the various Boards / Committees of other companies. The same is within permissible limits as provided by the Companies Act, 2013 and Listing Regulations.

The details of the Directors with regard to outside directorships and committee positions as at March 31, 2022 are as follows:

Director#	Category	No. of outside Companies Committee Positions Held <sup>4</sup>			Name of Outside Listed Entity where the person is a Director	Category of Directorship in outside Listed Entities
		No. of other Director-ships Held <sup>3</sup>	Public	Member		
Mr. Kumar Mangalam Birla <sup>5, 6</sup> [DIN: 00012813]	Non-Executive Chairman	07	-	-	1. Grasim Industries Limited 2. Aditya Birla Fashion and Retail Limited 3. UltraTech Cement Limited 4. Aditya Birla Sun Life AMC Limited 5. Century Textiles and Industries Limited 6. Aditya Birla Capital Limited	Non-Executive Chairman Non-Executive Chairman Non-Executive Chairman Non-Executive Chairman Non-Executive Chairman Non-Executive Chairman
Mrs. Rajashree Birla <sup>5, 6</sup> [DIN: 00022995]	Non-Executive	05	-	-	1. Grasim Industries Limited 2. UltraTech Cement Limited 3. Pilani Investment and Industries Corporation Limited 4. Century Textiles and Industries Limited 5. Century Enka Limited	Non-Executive Director Non-Executive Director Non-Executive Director Non-Executive Director Non-Executive Director
Mr. A. K. Agarwala <sup>2</sup> [DIN: 00023684]	Non-Executive	02	-	-	-	-
Mr. K. N. Bhandari [DIN: 00026078]	Independent <sup>1</sup>	09	07	03	1. Jaiprakash Associates Limited 2. Gujarat Sidhee Cement Limited 3. Saurashtra Cement Limited 4. Shristi Infrastructure Developments Corporation Limited	Independent Director Independent Director Independent Director Independent Director

Director#	Category	No. of outside Companies Committee Positions Held <sup>4</sup>			Name of Outside Listed Entity where the person is a Director	Category of Directorship in outside Listed Entities
		No. of other Director-ships Held <sup>3</sup>	Public	Member		
Mrs. Alka Bharucha [DIN: 00114067]	Independent <sup>1</sup>	08	10	04	1. UltraTech Cement Limited 2. Orient Electric Limited 3. Honda India Power Products Limited 4. Birlasoft Limited 5. Aditya Birla Sun Life AMC Limited	Independent Director Independent Director Independent Director Independent Director Independent Director
Mr. Y. P. Dandiwala [DIN: 01055000]	Independent <sup>1</sup>	03	05	01	1. Century Textile and Industries Limited 2. Pilani Investment and Industries Corporation Limited	Independent Director Independent Director
Mr. Satish Pai [DIN: 06646758]	Managing Director	-	-	-	-	-
Mr. Praveen Kumar Maheshwari [DIN: 00174361]	Whole-Time Director	01	-	-	-	-
Dr. Vikas Balia [DIN: 00424524]	Independent <sup>1</sup>	-	-	-	-	-
Mr. Sudhir Mital [DIN: 08314675]	Independent <sup>1</sup>	01	-	-	1. Jaiprakash Power Venture Limited	Independent Director
Mr. Anant Maheshwari (DIN No.02963839)	Independent <sup>1</sup>	-	-	-	-	-

- Independent Director means a director defined as such under Regulation 16 of the Listing Regulations and Section 149 of the Companies Act, 2013.
  - Mr. A. K. Agarwala was an Executive Director till September 10, 2003. Thereafter, he has moved to other responsibilities in the Aditya Birla Group.
  - Excludes Directorship held in Private Limited Companies, Foreign Companies and Companies under Section 8 of the Companies Act, 2013.
  - Represents only membership/chairmanship of Audit Committee and Stakeholders Relationship Committee of Indian Public Limited Companies. Further, membership includes Chairmanship.
  - No other Director is related to any other Director on the Board except for Mr. Kumar Mangalam Birla and Mrs. Rajashree Birla who are son and mother respectively.
  - Mr. Kumar Mangalam Birla and Smt. Rajashree Birla belong to the Promoter and Promoter group of the Company.
  - Mr. D. Bhattacharya (DIN: 00033553) has resigned as Non-Executive Director w.e.f March 02, 2022 due to personal reasons.
  - As per the Companies Act, 2013 maximum number of public companies in which a person can be appointed as director shall not exceed ten.
- # The average tenure of the Board as on 31st March, 2022 is approximately 12 years.

### Board's functioning and Procedure

Hindalco's Board of Directors plays a primary role in ensuring good governance and functioning of the Company. All statutory and other significant & material information including information as mentioned in Regulation 17 (7) read together with Schedule II of Listing Regulations is placed before the Board to enable it to discharge its responsibility of strategic supervision of the Company as trustees of the shareholders.

### Your Company's Board of Directors have identified the following skills / expertise / competencies to function and discharge their responsibilities effectively: -

- Industry knowledge
- Innovation, Technology and Digitalisation
- Financial literacy
- Corporate Governance, Legal and Compliance
- Strategic expertise
- Marketing
- Sustainability
- Risk Management
- Human Resource Development
- General Management



# Corporate Governance Report

Following are the names of the Directors with such skills / expertise / competencies

	Industry Knowledge	Innovation, Technology and Digitisation	Financial Literacy	Corporate Governance, Legal and Compliance	Strategic Expertise	Marketing	Sustainability	Risk Management	Human Resource Development	General Management	Metals and Mining
Kumar Mangalam Birla	✓	✓	✓	✓	✓	✓	✓	✓	✓	✓	✓
Rajashree Birla	✓			✓			✓			✓	
Satish Pai	✓	✓	✓	✓	✓	✓	✓	✓	✓	✓	✓
Praveen Kumar Maheshwari	✓	✓	✓	✓	✓		✓	✓	✓	✓	✓
A K Agarwala	✓	✓	✓	✓	✓	✓	✓	✓	✓	✓	✓
K N Bhandari	✓		✓	✓	✓		✓	✓	✓	✓	✓
Y P Dandiwala	✓		✓	✓	✓		✓	✓		✓	
Alka Bharucha	✓		✓	✓	✓		✓	✓		✓	
Vikas Balia	✓	✓	✓	✓	✓		✓	✓		✓	
Sudhir Mital	✓		✓	✓	✓		✓		✓	✓	
Anant Maheshwari	✓	✓	✓	✓	✓	✓	✓		✓	✓	

## Board members collectively display the following personal qualities:

- Integrity – fulfilling a director's duties and responsibilities;
- Curiosity and courage – to ask questions and courage to persist in asking or challenging management and fellow board members where necessary;
- Interpersonal skills – work well in a group, listen well, be tactful, able to communicate point of view frankly;
- Interest – in the organization, its business and the people;
- Instinct – good business instincts and acumen, ability to get to the crux of the issue quickly;
- Believer in gender diversity and
- Active participation – at deliberations in the meeting.

Your Company's Board comprises of 6 and 5 Independent and Non-Independent Directors respectively. The Directors are professionals, possessing wide experience and expertise in their areas of function - strategy; finance; governance and legal; marketing, insurance, among others, which together with their collective wisdom fuel your Company's growth. With one-sixth of the Board comprising of woman directors, the Board reflects gender diversity.

## A brief profile of the Directors of your Company is as follows:

**Kumar Mangalam Birla** was appointed as a Non-Executive Chairman of our Company with effect from October 19, 1995. He is the Chairman of the Board of Directors of your Company and the Chairman of Aditya Birla Group ("Group"), which operates in 36 countries across six continents. He is a chartered accountant and holds an MBA degree from the London Business School. Mr. Birla chairs the Boards of all major Group companies in India and globally. In the 26 years that he has been at the helm of the Group, he has accelerated growth, built meritocracy, and

enhanced stakeholder value. In the process he has raised the Group's turnover by over 25 times. He has been the architect of over 40 acquisitions in India and globally, among the highest by any Indian multinational. Under his stewardship, the Group enjoys a position of leadership in all the major sectors in which it operates, from cement to chemicals, metals to textiles, and apparels to financial services. Over the years, Mr. Birla has built a highly successful meritocratic organization, anchored by an extraordinary force of 140,000 employees belonging to 100 different nationalities. Outside the Group, Mr. Birla has held several key positions on various regulatory and professional Boards. He was a Director on the Central Board of Directors of the Reserve Bank of India. He was Chairman of the Advisory Committee constituted by the Ministry of Company Affairs and also served on the Prime Minister of India's Advisory Council on Trade and Industry. As the Chairman of the Securities and Exchange Board of India Committee on Corporate Governance, he framed the first-ever governance code for Corporate India.

Over the years, Mr. Birla has been conferred several prestigious awards. In 2021, he received the TiE Global Entrepreneurship Award for Business Transformation, the first Indian business leader to receive this honour. He is also the first Indian Industrialist to be conferred an Honorary degree by the Institute of Company Secretaries of India. Mr. Birla is deeply engaged with Educational Institutions. He is the Chancellor of the Birla Institute of Technology & Science ("BITS") with campuses in Pilani, Goa, Hyderabad and Dubai. He is also the Chairman of India's premier management institute — Indian Institute of Management, Ahmedabad. On the global arena, Mr. Birla is an Honorary Fellow of the London Business School. In 2019, Mr. Birla constituted a £15mn scholarship programme at the London Business School in memory of his grandfather, Mr. B. K. Birla, marking the largest ever endowed scholarship gift to a European Business School. A firm practitioner of the trusteeship concept, Mr. Birla has institutionalized the concept

of caring and giving at the Group. With his mandate, the Group is involved in meaningful welfare driven activities that distinctively enrich the lives of millions.

**Rajashree Birla** is a Non-Executive Director and was appointed on the Board of Directors on March 15, 1996. Mrs. Rajashree Birla is an exemplar in the area of community initiatives and rural development. Mrs. Birla spearheads the Aditya Birla Centre for Community Initiatives and Rural Development, the Group's apex body responsible for development projects. She oversees the social and welfare driven work across all the Group's major companies. The footprint of the Centre's work straddles over 7,000 villages, reaching out to 9 million people. The Group runs 20 hospitals and 56 schools where quality education is imparted to over 46,500 children. Both its hospitals as well as schools are 'Not for Profit' institutions. Mrs. Birla is the Chairperson of the FICCI – Aditya Birla CSR Centre for Excellence, Habitat for Humanity (India) and is on the Board of the Asia Pacific Committee as well as Habitat's Global Committee. She is the Chairperson of FICCI's first ever Expert Committee on CSR. She is on the Board of BAIF Development Research Foundation, Pune and also serves on the Board of Directors of the CSR Committee of the State Bank of India. As a patron of arts and culture, she heads the "Sangit Kala Kendra", a Centre for performing arts, as its President. In recognition of the exemplary work done by Mrs. Rajashree Birla, leading national and international organisations have showered accolades upon her. Among these the most outstanding one has been that of the Government of India which bestowed the "Padma Bhushan" Award in 2011 on Mrs. Rajashree Birla in the area of "Social Work". In recognition of Mrs. Birla's unrelenting endeavours towards polio eradication, she was honoured with the much coveted "Polio Eradication Champion" Award by the Government of India. Likewise, the "Global Golden Peacock Award for CSR" was conferred upon her by Dr. Ola Ullsten, the Former Prime Minister of Sweden in Portugal. Among other distinctive awards received by Mrs. Birla, feature the Economic Times' prestigious Award: Corporate Citizen of the Year, twice in a decade, first in 2003 and again in 2012; the All India Management Association's "Corporate Citizen of the Year Award", the IOD's "Distinguished Fellowship Award" and the "FICCI FLO Golden Laurel Award".

**Askaran Agarwala** is a Non-Executive Director of our Company and was appointed on the Board in 1998. He is a Trustee of several organisations including Sarla Basant Birla Param Bhakti Trust, Aditya Vikram Birla Memorial Trust, The Aditya Birla Foundation, Ladsaria Charitable & welfare Trust and Hellen Keller Institute of the Deaf and Blind. He holds a degree in Commerce and Law of Calcutta University and is fellow member of the Institute of Chartered Accountants of India.

**Mr. Sudhir Mital** is a Non-Executive Director and Independent Director of our Company with effect from November 11, 2019 for a period of five years. He is a graduate from Allahabad University with a Master's degree in Indian History. He also holds additional Masters in Rural Development from the University of Birmingham. He has been a former member of the

Indian Administrative Service from the Punjab Cadre, Secretary to Department of Fertilizers – Government of India, and Special Secretary to MCA. He was also a former acting Chairman of Competition Commission of India (CCI). Has rich professional experience in the fields of public policy and governance after nearly four decades of service. He has been a key functionary with regards to the Companies Bill, 2013

**Kailash Nath Bhandari** is a Non-Executive and Independent Director on the Board of our Company. Prior to joining our Company, he has also served as the Chairman and Managing Director of the New India Assurance Company Limited. He holds a Bachelor's degree in Arts and Law.

**Dr. Vikas Balia** is a Non-Executive Director and Independent Director of our Company with effect from July 19, 2019 for a period of five years, founder of Legalsphere Law firm, rank holding Chartered Accountant and a lawyer and has a Master's degree in Mercantile Laws with doctoral research (Ph. D) on Securitization Laws. He has varied and extensive experience on commercial and constitutional law. He is an adjunct faculty in many institutions and lectures for CA, Law and MBA students.

**Yazdi Dandiwala** is a Non-Executive Director and Independent Director of our Company with effect from August 14, 2015 for a period of five years. He is further reappointed for a period of five years w.e.f August 14, 2020. He is qualified as a Bachelor in Science and holds a degree in Law. He is Solicitor by profession. He is currently a partner of Mulla & Mulla and Craigie Blunt & Caroe, Advocates & Solicitors. He has experience as a corporate Commercial Lawyer with experience in corporate and commercial transactions.

**Alka Bharucha** is a Non-Executive Director and Independent Director of our Company with effect from July 11, 2018 for a period of five years. She earned her B.A (Hons) in 1976 and LLB in 1979 from University of Bombay, Masters in Law from the University of Bombay and University of London and Solicitor High Court Mumbai and Supreme Court of England and Wales. She began her career with Mulla & Mulla & Craigie Blunt & Caroe, and joined Amarchand & Mangaldas as partner in 1992. In 2008, she co-founded Bharucha & Partners which, on inception, was ranked by RSG Consulting, London among the top fifteen firms in India. Mrs. Bharucha has been ranked by Chambers Global, Legal 500 and Who's Who Legal amongst India's leading lawyers. She chairs the transactions practice at Bharucha & Partners. Her core areas of expertise are mergers and acquisitions, joint ventures, private equity, banking and finance.

**Anant Maheshwari** is presently President, Microsoft India. Prior to this he has worked with Honeywell Inc and McKinsey & Co. He currently chairs CII IT & ITeS committee and is a member of NASSCOM Exec Council. His career spans across the fields of Technology, Industrial & Automation, Enterprise & B2B markets, Strategy & Business Development.

**Satish Pai** was appointed as Whole-Time Director on our Board since August, 2013 and appointed as the Managing Director of our Company with effect from August 01, 2016

# Corporate Governance Report

for a period of five years. He was further reappointed by the Board of Directors at their meeting held on May 21, 2021 for a period of three years w.e.f. August 1, 2021. He holds a Bachelor's degree in Mechanical Engineering from the Indian Institute of Technology, Madras. He has experience in areas such as operations, recruitment, and training.

**Praveen Kumar Maheshwari** is a Whole Time Director and Chief Financial Officer of the Company. He joined the Company as its Chief Financial Officer in December 2011. He was inducted in the Board as the Whole Time Director in May 2016. He also worked as the CEO of Copper business of the Company for the period from 1<sup>st</sup> July 2019 to 30<sup>th</sup> April 2021. Mr. Maheshwari, a Chartered Accountant with an MBA from IIM – Ahmedabad, has over 39 years of work experience in areas of General Management and Finance, including mergers & acquisitions, fundraising, investor relations in India and global financial markets. Prior to joining Hindalco, he has worked with a number of business houses engaged in different industries. His last assignment before joining the Company was as Group CFO & Executive Director – Finance of Bharat Forge Limited. He is reappointed for a period of one year w.e.f 28<sup>th</sup> May 2022 by the Board of Directors subject to necessary approval by shareholders, in ensuing annual general meeting.

## Board Meetings

The Company Secretary drafts the agenda for each meeting along with the explanatory notes. The Board meets at Once a quarter to review the quarterly results and other items on the agenda. Various Board Committees meet as per the legal requirement or otherwise to transact the business delegated by Board of Directors.

Since the Companies Act 2013, read with the relevant rules made thereunder, facilitates the participation of Director in Board/Committee Meetings through video conferencing or other audio visual mode the option to participate in the meeting through video conferencing was made available for the Directors except in respect of such meetings/Items which are not permitted to be transacted through video conferencing.

The Members of the Board have complete freedom to express their opinion and decisions are taken after detailed discussion. The details of Board Meetings held during FY 2021-2022 are as outlined below:

Date of Board Meeting	City	No. of Directors Present
May 21, 2021	Mumbai	12 out of 12
July 02, 2021	Mumbai	12 out of 12
August 06, 2021	Mumbai	12 out of 12
September 17, 2021	Mumbai	11 out of 12
November 12, 2021	Mumbai	11 out of 12
January 20, 2022	Mumbai	12 out of 12
February 10, 2022	Mumbai	12 out of 12

The details of attendance of each Director at the Board Meetings and Last Annual General Meeting (AGM) are as follows:

Name of Director	No. of Board Meetings		Attended Last AGM@
	Held	Attended	
Mr. Kumar Mangalam Birla	7	7	Yes
Mrs. Rajashree Birla	7	5	Yes
Mr. A. K. Agarwala	7	7	Yes
Mr. D. Bhattacharya*	7	7	Yes
Mr. K. N. Bhandari	7	7	Yes
Mrs. Alka Bharucha	7	7	Yes
Mr. Y. P. Dandiwala	7	7	Yes
Mr. Satish Pai	7	7	Yes
Mr. Praveen Kumar Maheshwari	7	7	Yes
Dr. Vikas Balia	7	7	Yes
Mr. Sudhir Mital	7	7	Yes
Mr. Anant Maheshwari	7	7	Yes

@AGM held on 23<sup>rd</sup> August, 2021.

\* Mr. D. Bhattacharya tendered his resignation as Non-Executive Director w.e.f March 02, 2022.

Board attendance stood at 97.62% over a required attendance of 14.28%.

## Performance Evaluation of Board

Pursuant to the provisions of Companies Act, 2013 and Listing Regulations, the Directors have carried annual performance evaluation of Board, Independent Directors, Non-Executive Directors, Executive Directors, Committee and Chairman of the Board.

The evaluation framework focused on various aspects of Board and Committees such as review, timely information from management etc. Also, performance of individual directors was divided into Executive, Non-Executive and Independent Director and based on the parameters such as contribution, attendance, decision making, action oriented, external knowledge etc.

The evaluation exercise has been carried out by the Board on the basis of Evaluation template for Board, Independent Director, Non-Executive Director, Executive Directors, Committees and Chairman of the Board. The template had various questions to be replied by the directors on aforesaid parameters. The Nomination and Remuneration Committee evaluated the performance on the basis of response received from the Directors. Similarly, the Independent Directors evaluated the performance of Non Independent Directors, Chairman and assessed the quality, quantity and flow of information between the Company, Management and the Board.

Outcome of the evaluation exercise:

1. The Board as a whole perform satisfactorily.
2. Independent Directors are rated high in understanding the Company's business and expressing their view during the Board Meeting.
3. The Non-Executive Director scored well in all aspects.
4. Directors rated Executive Directors as action oriented and good in implementing Board decisions.
5. Board members rated high to the Chairman leading the board effectively.
6. Board members has shown satisfaction in functioning of the Committees.

## Independent Director's Meeting

During the year under review, the Independent Directors met without the presence of Non Independent Directors and members of the management inter alia to discuss:

- Evaluate the performance of Non Independent Directors and the Board of Directors as a whole.
- Evaluate the performance of the Chairman, taking into account the views of Executive and Non-Executive Directors.
- Evaluate the quality, content and timelines of flow of information between the Management and the Board that is necessary for the Board to effectively and reasonably perform its duties.

The Independent Directors expressed satisfaction on the overall performance of the Directors and the Board as a whole.

In the opinion of the Board, the Independent Directors fulfil all the conditions specified in the Listing Regulations as amended and are independent of the management.

## Familiarisation Programme for Independent Directors

All new Independent Directors inducted on the Board are given a letter of appointment setting out their roles, functions, duties and responsibilities.

The Directors are familiarized with your Company's Business and its operations. Interactions are held between the Directors and Senior Management of your Company. Directors are familiarized with organizational set-up, functioning of various department, internal control processes and relevant information pertaining to your Company. They are periodically updated on industry scenario, changes in regulatory framework and the impact thereof on the working of your Company.

The details on the Company's Familiarization Programme for Independent Directors can be accessed at: [http://www.hindalco.com/upload/pdf/Familiarisation\\_Programme\\_hindalco.pdf](http://www.hindalco.com/upload/pdf/Familiarisation_Programme_hindalco.pdf)

## Committees of the Board of Directors

The Board has constituted following Committees of Directors to deal with matters and monitor the activities falling within the respective terms of reference: -

### Audit Committee

#### Constitution of Audit Committee and its functions

Your Company has an Audit Committee at the Board level which acts as a link between the Management, the Statutory, the Internal Auditors and the Board of Directors and oversees the financial reporting process. The Committee is governed by a Charter which is line with the regulatory requirements mandated by the Companies Act, 2013 and Listing Regulations.

The Committee comprises of three Non-Executive Directors, all of whom are Independent Directors. The followings are the members of Audit Committee:

Mr. K.N. Bhandari	– Chairman
Mr. Y.P. Dandiwala	– Member
Dr. Vikas Balia	– Member

Mr. Anil Malik, Company Secretary also acts as Secretary to the Committee

During the year, the Audit Committee met 6 times i.e., on April 09, 2021, May 21, 2021, August 06, 2021, October 11, 2021, November 12, 2021 and February 10, 2022 to deliberate on various matters. The attendance of each Audit Committee members are as follows:

Name of the Director	No. of Meetings held	No. of Meetings Attended
Mr. K. N. Bhandari	6	6
Mr. Y. P. Dandiwala	6	6
Dr. Vikas Balia	6	6

1. The Chairman of the Audit Committee, Mr. K. N. Bhandari was present at the last Annual General Meeting of your Company held on August 23, 2021.
2. The Managing Director, Whole-Time Director and CFO, the representative of the Statutory Auditor, Head of the Internal Audit are permanent invitees of the Audit Committee. The representative of the Cost Auditors is invited to the Audit Committee Meetings whenever matters relating to cost audit is considered.

#### Role of Audit Committee:

- (1) Oversight of the listed entity's financial reporting process and the disclosure of its financial information to ensure that the financial statement is correct, sufficient and credible;



# Corporate Governance Report

- (2) Recommendation for appointment, remuneration and terms of appointment of auditors of the listed entity;
- (3) Approval of payment to statutory auditors for any other services rendered by the statutory auditors;
- (4) Reviewing, with the management, the annual financial statements and auditor's report thereon before submission to the board for approval, with particular reference to:
- Matters required to be included in the Director's Responsibility Statement to be included in the Board's Report in terms of clause (c) of sub section (3) of Section 134 of the Companies Act, 2013;
  - Changes, if any, in accounting policies and practices and reasons for the same;
  - Major accounting entries involving estimates based on the exercise of judgment by management;
  - Significant adjustments made in the financial statements arising out of audit findings;
  - Compliance with listing and other legal requirements relating to financial statements;
  - Disclosure of any related party transactions;
  - Modified opinion(s) in the draft audit report;
- (5) Reviewing, with the management, the quarterly financial statements before submission to the board for approval;
- (6) Reviewing, with the management, the statement of uses / application of funds raised through an issue (public issue, rights issue, preferential issue, etc.), the statement of funds utilized for purposes other than those stated in the offer document / prospectus / notice and the report submitted by the monitoring agency monitoring the utilisation of proceeds of a public or rights issue, and making appropriate recommendations to the board to take up steps in this matter;
- (7) Reviewing and monitoring the auditor's independence and performance, and effectiveness of audit process;
- (8) Approval or any subsequent modification of transactions of the listed entity with related parties;
- (9) Scrutiny of inter-corporate loans and investments;
- (10) Valuation of undertakings or assets of the listed entity, wherever it is necessary;
- (11) Evaluation of internal financial controls and risk management systems;
- (12) Reviewing, with the management, performance of statutory and internal auditors, adequacy of the internal control systems;
- (13) Reviewing the adequacy of internal audit function, if any, including the structure of the internal audit department, staffing and seniority of the official heading the department, reporting structure coverage and frequency of internal audit;
- (14) Discussion with internal auditors of any significant findings and follow up there on;
- (15) Reviewing the findings of any internal investigations by the internal auditors into matters where there is suspected fraud or irregularity or a failure of internal control systems of a material nature and reporting the matter to the board;
- (16) Discussion with Statutory Auditors before the audit commences, about the nature and scope of audit as well as post-audit discussion to ascertain any area of concern;
- (17) To look into the reasons for substantial defaults in the payment to the depositors, debenture holders, shareholders (in case of non-payment of declared dividends) and creditors;
- (18) To review the functioning of the whistle blower mechanism;
- (19) Approval of appointment of Chief Financial Officer after assessing the qualifications, experience and background, etc. of the candidate;
- (20) Carrying out any other function as is mentioned in the terms of reference of the Audit Committee.
- (21) Reviewing the utilisation of the loans and / or advances from / investments by the Holding Company in the subsidiary exceeding ₹ 100 crore or 10% of the asset size of the subsidiary, whichever is lower including existing loans / advances/ investments existing as on April 01, 2019.
- (22) consider and comment on rationale, cost-benefits and impact of schemes involving merger, demerger, amalgamation etc., on the listed entity and its shareholders.
- B. The audit committee reviews the following information:
- Management Discussion and Analysis of financial condition and results of operations;
  - Statement of significant related party transactions (as defined by the audit committee), submitted by management;
  - Management letters / letters of internal control weaknesses issued by the Statutory Auditors;
  - Internal audit reports relating to internal control weaknesses; and
  - The appointment, removal and terms of remuneration of the Chief Internal Auditor;

(6) Statement of deviations:

- Quarterly statement of deviation(s) including report of monitoring agency, if applicable, submitted to Stock Exchange(s) in terms of Regulation 32(1) of the Listing Regulations.
- Annual statement of funds utilized for purposes other than those stated in the offer document/prospectus/notice in terms of Regulation 32(7) of the Listing Regulations.

## Stakeholder's Relationship Committee

The Company has a "Stakeholder's Relationship Committee" at the Board level to specifically look into various aspects of interests of shareholders, debenture holders and other security holders.

The role of the committee is to specifically look into various aspects of interest of shareholders, debenture holders and other security holders including:

- Resolving the grievances of the security holder of the Company including complaints related to transfer/transmission of shares, non-receipt of Annual Reports non-receipts of declared dividends issue of new/duplicate Certificate, General Meetings etc.
- Review of measures taken for effective exercise of voting rights by shareholders.
- Review of various measures and initiatives taken by the listed entity for reducing the quantum of unclaimed dividends and ensuring timely receipt of dividend warrants/ annual reports/ statutory notices by the shareholders of the Company.

The following are the members of the Committee:

- Mr. K. N. Bhandari – Chairman  
Mr. A. K. Agarwala – Member  
Mr. Satish Pai – Member

Mr. Anil Malik, Company Secretary, is the Compliance officer and acts as secretary to the Committee.

During the year under review, the Committee met four times i.e on May 05, 2021, August 02, 2021, November 08, 2021 and February 07, 2022 to deliberate on various matters referred above. Details of attendance by Directors for the Committee meetings are as follows:

Name of the Director	No. of Meetings	No. of Meetings Attended
Mr. K. N. Bhandari	4	4
Mr. A. K. Agarwala	4	4
Mr. Satish Pai	4	4

The Company's shares are compulsorily traded and delivered in the dematerialized form in all Stock Exchanges. To expedite the transfer in the physical segment, necessary authority has been delegated to certain officers, who are authorized to transfer up to 10,000 shares under one transfer deed.

## Number of shareholders complaints received so far/ number not solved to the satisfaction of shareholders/ number of pending complaints

Details of complaints received, disposed off and pending during the year, number of shares transferred during the year, time taken for affecting these transfers and the number of share transfers pending are furnished in the "Shareholder Information" section of this Annual Report.

## Nomination and Remuneration Committee

The Board has formed a Nomination and Remuneration Committee consisting of the following members:

- Mr. K. N. Bhandari – Chairman  
Mr. Kumar Mangalam Birla – Member  
Mr. Y. P. Dandiwala – Member

Mr. Anil Malik, Company Secretary also acts as Secretary to the Committee

As per Section 178 of Companies Act, 2013 and Regulation 19 of Listing Regulations, the terms of reference are as follows:

- Identify persons who are qualified to become directors and who may be appointed in senior management in accordance with the criteria laid down and recommend to the board of directors their appointment and removal.
- For every appointment of an independent director, to evaluate the balance of skills, knowledge and experience on the Board and on the basis of such evaluation, prepare a description of the role and capabilities required of an independent director. The person recommended to the Board for appointment as an independent director shall have the capabilities identified in such description. For the purpose of identifying suitable candidates, the Committee may:
  - Use the services of an external agencies, if required;
  - Consider candidates from a wide range of backgrounds, having due regard to diversity;
  - Consider the time commitments of the candidates.
- Formulation of criteria for evaluation of performance of Independent Directors and the Board.
- Carry out evaluation of every Director's performance.
- Formulate the criteria for determining qualifications, positive attributes and independence of a Director.

# Corporate Governance Report

- Recommend to the Board a policy, relating to the remuneration for the Directors, Key Managerial Personnel and other employees.
- Devise a policy on Board diversity.
- Whether to extend or continue the term of appointment of Independent Director on the basis of report of performance evaluation of Independent Director.
- Recommend to the board, all remuneration, in whatever form, payable to senior management.

The Board of Directors are elected individually based on the recommendation of the Nomination and Remuneration Committee. Their appointment is approved by the Board and subsequently confirmed by the shareholders at the Annual General Meeting.

The scope and functions of the Committee is in accordance with the provisions of the Companies Act, 2013 and Listing Regulations.

During the year under review, the Committee met three times i.e on May 21, 2021, August 06, 2021 and November 12, 2021 to deliberate on various matters referred above. The details of attendance of the members is as below:

Name of the Director	No. of Meetings	No. of Meetings Attended
Mr. K. N. Bhandari	3	3
Mr. K. M. Birla	3	3
Mr. Y. P. Dandiwala	3	3

Performance Evaluation criteria for independent directors:

- The Director invests time in understanding the Company and its unique requirements.
- The Director brings in external knowledge and perspective to the table for discussion.
- The Director expresses her / his views on issues discussed at the Board.
- The Director keeps himself / herself updated on areas and issues that are likely to be discussed at the Board level.

## Corporate Social Responsibility Committee (CSR)

The Corporate Social Responsibility Committee comprises of the following members:

Mrs. Rajashree Birla	–	Chairman
Mr. Satish Pai	–	Member
Mr. A.K. Agarwala	–	Member

Mr.D. Bhattacharya\* – Member  
Mr. Y. P. Dandiwala – Member

\*(Resigned w.e.f. 02<sup>nd</sup> March, 2022)

Dr. Mrs. Pragnya Ram: Group Executive President: Corporate Communications and CSR is a permanent invitee to the Committee.

Mr. Anil Malik, Company Secretary also acts as Secretary to the Committee.

The terms of reference of Corporate Social Responsibility Committee broadly comprises of following:

- Formulate and Recommendation of CSR Policy to the Board indicating the activities to be undertaken by the Company as specified in Schedule VII of Companies Act, 2013.
- Recommend the amount of expenditure to be incurred on the activities referred to in clause(a).
- Provide guidance on various CSR activities to be undertaken by the Company and to monitor its progress.

During the year under review, the Committee met once i.e. on May 19, 2021 to deliberate on various matters referred above. The details of attendance of the members is as below:

Name of the Director	No. of Meetings	No. of Meetings Attended
Smt. Rajashree Birla	1	1
Mr. Satish Pai	1	1
Mr. D. Bhattacharya	1	1
Mr. A K Agarwala	1	1
Mr. Y. P. Dandiwala	1	1

## Risk Management & Environment Social and Governance (ESG) Committee

The Risk Management Committee has been renamed to Risk Management & Environment, Social and Governance (ESG) Committee at the board meeting held on February 10, 2022.

The Company has a robust risk management framework to identify, monitor and minimize risk as also identify business responsibilities.

Your Company has comprehensive Risk Management Policy. The following are the Members of the Committee:

- Mr. A.K. Agarwala – Chairman
- Mr. Satish Pai – Member
- Mr. D. Bhattacharya\* – Member
- Mr. K N Bhandari\*\* – Member
- Mr. Praveen Kumar Maheshwari – Member

- Mr. Anil Arya – Member
- Mr. Anil Mathew – Member
- Mr. Vikram Sondhi \*\*\* – Member
- Mr. Unnikrishnan Prabhakaran\*\*\*\* – Member

\*Resigned as a member w.e.f. 02<sup>nd</sup> March, 2022

\*\*Inducted as a member w.e.f. 21<sup>st</sup> May, 2021

\*\*\*Ceased to be a member w.e.f. 12<sup>th</sup> November, 2021

\*\*\*\*Inducted as a member w.e.f. 12<sup>th</sup> November, 2021

Mr. Anil Malik, Company Secretary is Compliance Officer of the Committee and also acts as Secretary to the Committee.

During the year under review, the Committee met four times i.e. on April 08, 2021, July 08, 2021, October 08, 2021 and January 10, 2022 to deliberate on various matters. Details of attendance by Directors for the Committee meetings are as follows:

Name of the Director / Member	No. of Meetings	No. of Meetings Attended
Mr. A. K. Agarwala	4	4
Mr. Satish Pai	4	4
Mr. D. Bhattacharya	4	4
Mr. K N Bhandari	3	3
Mr. Praveen Kumar Maheshwari	4	4
Mr. Anil Arya	4	4
Mr. Anil Mathew	4	3
Mr. Vikram Sondhi	3	3
Mr. Unnikrishnan Prabhakaran	1	1

The role of the committee shall, inter alia, include the following:

- To formulate a detailed risk management policy which shall include:
  - A framework for identification of internal and external risks specifically faced by the listed entity, in particular including financial, operational, sectoral, sustainability (particularly, ESG related risks), information, cyber security risks or any other risk as may be determined by the Committee.
  - Measures for risk mitigation including systems and processes for internal control of identified risks.
  - Business continuity plan.
- To ensure that appropriate methodology, processes and systems are in place to monitor and evaluate risks associated with the business of the Company;
- To monitor and oversee implementation of the risk management policy, including evaluating the adequacy of risk management systems;

- To periodically review the risk management policy, at least once in two years, including by considering the changing industry dynamics and evolving complexity;
- To keep the board of directors informed about the nature and content of its discussions, recommendations and actions to be taken;
- The appointment, removal and terms of remuneration of the Chief Risk Officer (if any) shall be subject to review by the Risk Management Committee.

## Non-Executive Director's Compensation and Disclosure

All fees/compensation including sitting fee paid to the Non-Executive Directors of the Company are fixed by Board of Directors within the limits approved by the shareholders. Details of sitting fees/compensation paid including stock options, if any, to them are given at the respective places in the report.

## Remuneration of Directors and Others

Your Company has two Executive Directors, the Board of Directors decides the remuneration of the Managing Director and Whole-Time Director on the recommendation of Nomination and Remuneration Committee.

The Company has a system where all the Directors or Senior Management of the Company are required to disclose all pecuniary relationship or transactions with the Company. There were no pecuniary relationships or transactions between your Company and Non-Executive Director during the year.

Besides sitting fees ₹ 50,000/- per meeting of the Board, ₹ 25,000/- per meeting of the Audit Committee and ₹ 20,000/- per meeting for any other Committee thereof, the Company also pays Commission to the Non-Executive Directors.

For FY 2021-22, the Board has approved payment of ₹ 7.00 crore (previous year ₹ 6.00 crores) as Commission to the Non-Executive Directors of the Company pursuant to the authority given by the shareholders at the Annual General Meeting held on September 24, 2014 to pay Commission not exceeding 1% of the net profits of the Company to the Non-Executive Directors of the Company. The amount of commission payable is determined after assigning weightage to attendance and the type of meeting and other responsibilities.

Executive Directors are paid remuneration within the limits envisaged under Section 197, Schedule V of Companies Act, 2013. The said remuneration is approved by the Board as well as shareholders of the Company.



# Corporate Governance Report

## The details of Remuneration package, fees paid etc. to Directors for the year ended March 31, 2022:

### (a) Non-Executive Directors:

Name of Director	Sitting Fees Paid (₹ In Lakhs)	Commission payable (₹ In Lakhs)	Total Payments Paid / Payable in 2021-22 (₹ In Lakhs)
Mr. Kumar Mangalam Birla <sup>1,2</sup>	4.10	-	4.10
Mrs. Rajashree Birla <sup>2</sup>	2.70	348.01	350.71
Mr. A. K. Agarwala	6.10	37.97	44.07
Mr. D. Bhattacharya <sup>6</sup>	5.30	34.62	39.92
Mr. Anant Maheshwari	3.50	31.61	35.11
Mr. K. N. Bhandari	7.00	61.42	68.42
Mrs. Alka Bharucha	3.50	36.61	40.11
Mr. Y. P. Dandiwala	6.60	57.75	64.35
Dr. Vikas Balia	5.00	54.40	59.40
Mr. Sudhir Mital	3.50	37.61	41.11

#### Notes:

- Mr. Kumar Mangalam Birla assumed the role of Executive Chairman of Aditya Birla Management Corporation Private Limited w.e.f. January 01, 2019. Accordingly, he would not like to receive any commission from your Company w.e.f. January 01, 2019.
- No Director is related to any other Director on the Board, except Mr. Kumar Mangalam Birla and Mrs. Rajashree Birla, who are son and mother respectively.
- Your Company has a policy of not advancing any loan to its Directors except to Executive Director in the course of normal employment.
- The Company has obtained shareholders' approval for payment of commission to its Non-Executive Directors & Independent Directors, not exceeding 1% of Net Profit of the Company.
- Stock Options were not granted to any Non-Executive Directors.
- Mr. D Bhattacharya has resigned as Non-Executive Director w.e.f. March 02, 2022. In addition to above, the Board approved pension of Mr. D. Bhattacharya of ₹ 0.335 crore per month and other post-employment benefits for his past service when he was the Managing Director of the Company. The present value of the above pension liability determined based on the actuarial valuation is accounted by the Company in its financial statements. Amount charged as expenses in the statement of profit and loss during the year towards such post-employment benefit amounting to ₹ 3 crore has been disclosed as a part of managerial remuneration above, and does not include the impact of actuarial (gains)/losses recognised in other comprehensive income.

### (b) Paid to Executive Directors

Executive Director	Remuneration for the year 2021-22				
	Relationship with other Directors	All elements of remuneration package i.e., salary, benefits, bonuses, pension etc. (₹ in Lakhs)	Fixed component & performance linked incentives, along with performance criteria (₹ in Lakhs)	Service contracts, notice period, severance fee	Stock option details, if any
Mr. Satish Pai (Managing Director) See Note (a), (e)	None	35,55,17,143	10,97,30,000	See Note (b)	See Note (c)
Mr. Praveen Kumar Maheshwari (Whole-Time Director) See Note (e)	None	4,13,06,084	2,26,60,897	See Note (b)	See note (d)

- Mr. Satish Pai Managing Director was paid a sum of ₹ 10,97,30,000 towards performance bonus linked to achievement of targets for FY 2020-2021. (vested at the end of 1 year from date of grant). He has exercised 722,186 stock options during FY 2021-22. No RSUs were exercised during FY 2021-22.
- The appointment is subject to termination by three months notice in writing on either side. No severance fee is payable to the Managing Director or Whole-Time Director. During FY 2020-21, no Stock Options or RSUs were granted. He has exercised 65,652 stock options during FY 2020-21. No RSUs were exercised during FY 2020-21. Stock options and RSUs are exercisable within 5 years from the date of vesting.
- During FY 2021-22, the Company granted 986,841 Stock Options (vested 33.33% each year over a period of 3 years from the date of grant) along with 137,969 RSUs (vested at the end of 3 years from date of grant) and 165,562 RSUs (vested at the end of 1 year from date of grant). During FY 2021-22, the Company granted 40,323 Stock Options (vested 33.33% each year over a period of 3 years from the date of grant) along with 5,655 RSUs (vested

at the end of 3 years from date of grant) and 11,312 RSUs (vested at the end of 1 year from date of grant). No stock options or RSUs exercised were exercised during FY 2021-22.

During FY 2020-21, the Company granted 29,779 Stock Options (vested at the end of 1 year from date of grant). No stock options or RSUs were exercised by Mr. Praveen Kumar Maheshwari in FY 2020-21.

Stock options and RSUs are exercisable within 5 years from the date of vesting.

- Remuneration excludes amortisation of fair value of employee share based payments under Ind AS 102 and liabilities for defined benefit plans provided on actuarial basis.

All Directors have disclosed their shareholding in the Company. None of the Directors are holding any debentures or any other instruments of the Company. Details of shareholding of Directors as on March 31, 2022 are as follows:

Name of the Directors	No. of shares held
Mr. Kumar Mangalam Birla*	901,635
Mrs. Rajashree Birla	612,470
Mr. A. K. Agarwala	108,648
Mr. K. N. Bhandari	5,071
Mr. Y. P. Dandiwala	267
Mrs. Alka Bharucha	-
Mr. Satish Pai	722,564
Mr. Praveen Kumar Maheshwari	-
Dr. Vikas Balia	325
Mr. Sudhir Mital	-
Mr. Anant Maheshwari	-

\*Additionally he holds 648,632 equity shares as Karta of Aditya Vikram Kumar Mangalam Birla HUF.

### Code of Conduct

The Hindalco Code of Conduct, as adopted by the Board of Directors, is applicable to all Directors, Senior Management of the Company. The Code is available on the Company's website viz: <http://www.hindalco.com/upload/pdf/hindalco-code-of-conduct-BODs-SMP.pdf>

### Declaration of compliance with Code of Conduct

I hereby confirm that the Board of Directors and Senior Management have affirmed compliance with Code of Conduct of the Company for the financial year ended 31st March, 2022.

Place: Mumbai  
Date: 22<sup>nd</sup> July, 2022

**SATISH PAI**  
Managing Director  
DIN: [06646758]

### Code of Conduct for Prevention of Insider Trading

In terms of the provisions of the Securities and Exchange Board of India (Prohibition of Insider Trading) Regulations, 2015, as amended, your Company has adopted a 'Code of Conduct to regulate, monitor and report trading by designated persons in listed or proposed to be listed securities' of your Company ("the Code"). The Code aims at preserving and preventing misuse of unpublished price sensitive information. All Designated Persons (including Directors, Key Managerial Personnel and Employees) of your Company are covered under the Code, which provides inter alia for periodical disclosures and obtaining pre-clearances for trading in securities of your Company.

### Subsidiary Companies

The Company has adopted a policy for determining 'material' subsidiaries and the policy can be accessed on your Company's website viz: <http://www.hindalco.com/upload/pdf/hil-policy-on-material-subsiary.pdf>

The Company is in compliance with the requirements of Regulation 24 of Listing Regulations with respective Corporate Governance for its subsidiary companies.

### Disclosures

#### (A) Related Party Transactions

All the related party transactions are strictly done on arm's length basis. The Company places all the relevant details of a related party transaction, entered in the normal course of business, before the Audit Committee from time to time. There was no material related party transaction, which are not in the normal course of the business, entered into by the Company during the year. Attention of the Members is drawn to the disclosures of transactions with the related parties set out in Notes to Accounts forming part of the Financial Statements. The Board of Directors have approved and adopted a policy on Related Party Transactions and the same has been uploaded on the website of the Company at <http://www.hindalco.com/investor-centre/policies>

#### (B) Non Compliances/Strictures/penalties Imposed

No Non Compliance/strictures/penalties have been imposed on the Company by Stock Exchange(s) or SEBI or any Statutory Authority on any matters related to capital markets during the last three years.

#### (C) Disclosure of Accounting Treatment

Your Company has followed all relevant Accounting Standards while preparing the Financial Statements.

#### (D) Risk Management

Risk evaluation and management is an ongoing process within the organisation. Your Company has comprehensive

# Corporate Governance Report

Risk Management Policy and it is periodically reviewed by the Board of Directors.

**(E) Proceeds from public issues, right issues, preferential issues, qualified institutions placement etc:**

During the year under review, the Company has not raised any proceeds from public issues, right issues or preferential issues, qualified institutions placement etc.

**(F) Remuneration of Directors**

This is included separately in this Section.

**(G) Management**

Management Discussion and Analysis Report is prepared in accordance with the requirements laid out under Listing Regulations forms part of Annual Report. No material transaction has been entered into by the Company with the Promoters, Directors or the Management, their subsidiaries or relatives, etc., that may have a potential conflict with interests of the Company.

**(H) Shareholders**

**(i)** The Company has provided the details of Directors seeking appointment/re-appointment in the Annual General Meeting Notice attached with this Annual Report.

**(ii)** Quarterly Presentations on the Company results are available on the website of the Company (www.hindalco.com) and the Aditya Birla Group website (www.adityabirla.com).

**(iii) Details of total fees paid to Statutory Auditor**

During the FY 2021-22, the total fees charged for audit, audit related services and non-assurance services provided by Price Waterhouse & Co Chartered Accountants LLP (FRN 304026E/ E300009) and other member firms of PricewaterhouseCoopers global network of firms to the Company and its subsidiaries on a consolidated basis is as follows:

(₹ in crore)

	Price Waterhouse & Co Chartered Accountants LLP*	Other member firms of Price waterhouse Coopers global network of firms*
Statutory audit and Limited Review	4.51	61.40
Audit of special purpose financial statements of certain foreign subsidiaries	0.17	-
Audit related services – Certifications	0.19	0.52
<b>Total</b>	<b>4.87</b>	<b>61.92</b>

\*Excludes Taxes and Out of pocket expenses.

**Whistle Blower Policy**

The Company promotes ethical behaviour in all its business activities and has put in place a mechanism for reporting illegal and unethical behaviour. The Company has a Vigil Mechanism and Whistle Blower Policy under which employees are free to report violations of applicable laws and regulations and Code of Conduct. The whistle blower may send the complaint to the independent reporting mechanism - Ethics Hotline or to the respective Values Standards Committee (VSC), depending on the level at which the violation is perceived to be happening, or the seniority of the individual/s involved. Employees may also report to the Chairman of the Audit Committee. During the year under review, no employee was denied access to the Audit Committee.

We have a Code of Conduct, Vigil Mechanism and Whistle-Blower Policy, and Supplier Code of Conduct in place through which we promote ethical behaviour in all our business activities. Our Code, policies and standards promote ethical behaviour which helps to prevent /detect any violation of our Code of Conduct.

**Prevention of Sexual Harassment**

Your Company has zero tolerance for sexual harassment at workplace and has adopted a Policy on prevention, prohibition and redressal of sexual harassment at workplace in line with the provisions of the Sexual Harassment of Women at Workplace (Prevention, Prohibition and Redressal) Act, 2013 and the Rules thereunder for prevention and redressal of complaints of sexual harassment at workplace.

The Company is committed to providing equal opportunities without regard to their race, caste, sex, religion, colour, nationality, disability etc. All women associates (permanent, temporary, contractual and trainees) as well as any women visiting the Company's office premises or women service providers are covered under this policy. All employees are treated with dignity with a view to maintain a work environment free of sexual harassment whether physical, verbal or psychological.

The Details of complaints filed, disposed and pending during the FY 2021-22 is as given below:

Number of complaints filed during the financial year	Number of complaints disposed during the financial year	Number of complaints pending as at end of the financial year
6	8*	0

\*Includes two complaints pending last year and resolved this year

**CEO/CFO Certification**

The Managing Director and CFO have certified to the Board that:

A. They have reviewed Financial Statements and the Cash Flow Statement for the year and that to the best of their knowledge and belief:

- these statements do not contain any materially untrue statement or omit any material fact or contain statements that might be misleading;
- these statements together present a true and fair view of the Company's affairs and are in compliance with existing Accounting Standards, applicable laws and regulations.

B. There are, to the best of their knowledge and belief, no transactions entered into by the Company during the year which are fraudulent, illegal or violative of the Company's code of conduct.

C. They accept responsibility for establishing and maintaining internal controls for financial reporting and that they have evaluated the effectiveness of internal control systems of the Company pertaining to financial reporting and they have disclosed to the Auditors and the Audit Committee, deficiencies in the design or operation of such internal controls, if any, of which they are aware and the steps they have taken or propose to take to rectify these deficiencies.

D. They have indicated to the Auditors and the Audit Committee:

- that there were no significant changes in internal control over financial reporting during the year;
- that there were no significant changes in accounting policies during the year and that the same have been disclosed in the notes to the Financial Statements; and
- instances of significant fraud of which they have become aware and the involvement therein, if any, of the management or an employee having a significant role in the Company's internal control system over financial reporting.

**Report on Corporate Governance**

Your Company has complied with Corporate Governance requirements specified under Regulations 17 to 27 and clauses (b) to (i) of sub regulation (2) of Regulation 46 of the Listing Regulations.

**COMPLIANCE**

I. A certificate from the Statutory Auditors confirming compliance with the conditions of Corporate Governance as stipulated in Listing Regulations forms part of Annual Report.

II. A Certificate by Company Secretary in practice that none of the directors have been debarred or disqualified from being appointed for continuing as directors in the companies by the Board/Ministry of Corporate Affairs or any such statutory authority forms part of Annual Report As below:-

**CERTIFICATE**

**Pursuant to regulation 34(3) and Schedule V Para C clause (10)(i) of the SEBI (Listing Obligations and Disclosure Requirements) Regulations, 2015 ("SEBI Listing Regulations")**

To

**The Members**

Hindalco Industries Limited  
Ahura Centre, 1st Floor,  
B Wing Mahakali Caves Road,  
Mumbai – 400093

We have examined the relevant books, papers, minutes books, forms and returns filed, Notices received from the Directors during the financial Year 2021-22, and other records maintained by the Company and also the information provided by the Company, its officers, agents and authorised representatives of **Hindalco Industries Limited CIN.: L27020MH1958PLC011238** (hereinafter called the 'Company') having its Registered office at Ahura Centre, 1st Floor, B Wing Mahakali Caves Road, Mumbai – 400093 for the purpose of issue of a Certificate, in accordance with Regulation 34 (3) read with Schedule V Para-C Sub clause 10 (i) of the Securities Exchange Board of India (Listing Obligations and Disclosure Requirements) 2015 (LODR), as amended vide notification no [SEBI/LAD/NRO/GN/2018/10 dated May 9, 2018 issued by SEBI.

In our opinion and to the best of our knowledge and based on such examination as well as information and explanations furnished to us, which to the best of our knowledge and belief were necessary for the purpose of issue of this certificate and based on such verification as considered necessary, we hereby certify that None of the Directors stated below who are on the Board of the Company as on 31<sup>st</sup> March 2022 have been debarred or disqualified from being appointed or continuing as Directors of the Companies by Securities Exchange Board of India or The Ministry of Corporate Affairs or any such other statutory authority.

S. No.	Name of the Director	DIN	Date of Appointment in the Company
1	Kumar Mangalam Birla	00012813	16/11/1992
2	Rajashree Birla	00022995	15/03/1996
3	Aksaran Agarwala	00023684	11/09/1998
4	Kailash Nath Bhandari	00026078	30/01/2006
5	Debnarayan Bhattacharya*	00033553	01/10/2008
6	Alka Marezban Bharucha	00114067	11/07/2018



# Corporate Governance Report

S. No.	Name of the Director	DIN	Date of Appointment in the Company
7	Praveen Kumar Maheshwari	00174361	28/05/2016
8	Yazdi Piroj Dandiwala	01055000	14/08/2015
9	Vikas Balia	00424524	19/07/2019
10	Satish Pai	06646758	13/08/2013
11	Sudhir Mital	08314675	11/11/2019
12	Anant Maheshwari	02963839	14/08/2020

\*Resignation of Debnarayan Bhattacharya with effect from March 02, 2022.

Ensuring the eligibility for the appointment / continuity of every Director on the Board is the responsibility of the management of the Company. Our responsibility is to express an opinion on these based on our verification. This certificate is neither an assurance as to the future viability of the Company nor of the efficiency or effectiveness with which the management has conducted the affairs of the Company.

**For BNP & Associates**  
Company Secretaries  
[Firm Regn. No. P2014MH037400]

**Avinash Bagul**  
Partner

**Dated: 23<sup>rd</sup> May 2022** FCS No: 5578 COP No.: 19862  
**Place: Mumbai** UDIN: F005578D000363518

## General Body Meetings

Details of Annual General Meetings

Location and time, where Annual General Meetings (AGMs) in the last three years were held:-

Year	AGM	Location	Date	Time
2020-21	AGM	By Video conferencing Mumbai	August 23, 2021	3.00 p.m.
2019-20	AGM	By Video conferencing Mumbai	September 10, 2020	3.00 p.m.
2018-19	AGM	Nehru Centre Auditorium	August 30, 2019	3.00 p.m.

In the last three years special resolution as set out in the respective notices for AGM's were passed by shareholders.

Whether any special resolution passed last year through postal ballot? : No

Person who conducted the postal exercise: : Not Applicable

Whether any special resolution is proposed to be conducted through postal ballot : No

## Means of Communication

- Quarterly Results:

Newspaper	Cities of Publication
Business Standard (English)	All editions
Navshakti (Marathi)	Mumbai Edition only
Any website, where displayed: www.hindalco.com www.adityabirla.com	
Whether the Company Website displays	
➤ All official news releases	Yes
➤ Presentation made to Institutional Investors/Analysts	Yes

## General Shareholder Information

The same is provided in the 'Shareholder Information' section.

## Status of compliance of Non mandatory requirement

- The Company maintains a separate office for the Non-Executive Chairman. All necessary infrastructure including vehicles for business purpose and assistance are available to enable him discharge his responsibilities effectively.
- During the period under review, there is no audit qualification in the financial statement.
- The post of the Non-Executive Chairman of the Board is separate from that of the Managing Director/CEO.
- The Company has engaged internal auditors for aluminum and copper business separately and their report is reviewed by the Audit Committee.

## Auditor's Certificate regarding compliance of conditions of Corporate Governance

To the Members of Hindalco Industries Limited

We have examined the compliance of conditions of Corporate Governance by Hindalco Industries Limited ("the Company"), for the year ended March 31, 2022 as stipulated in Regulations 17, 17A, 18, 19, 20, 21, 22, 23, 24, 24A, 25, 26, 27 and clauses (b) to (i) and (t) of sub-regulation (2) of regulation 46 and para C, D and E of Schedule V of the Securities and Exchange Board of India (Listing Obligations and Disclosure Requirements) Regulations, 2015 (as amended) (collectively referred to as "SEBI Listing Regulations, 2015").

The compliance of conditions of Corporate Governance is the responsibility of the Company's management. Our examination was carried out in accordance with the Guidance Note on Certification of Corporate Governance, issued by the Institute of Chartered Accountants of India and was limited to procedures and implementation thereof, adopted by the Company for ensuring the compliance of the conditions of Corporate Governance. It is neither an audit nor an expression of opinion on the financial statements of the Company.

In our opinion and to the best of our information and according to the explanations given to us, we certify that the Company has complied with the conditions of Corporate Governance as stipulated in the SEBI Listing Regulations, 2015.

We state that such compliance is neither an assurance as to the future viability of the Company nor the efficiency or effectiveness with which the management has conducted the affairs of the Company.

For **Price Waterhouse & Co Chartered Accountants LLP**  
Firm Registration No. 304026E/E-300009

UDIN: 22045255ANKZDI4014  
Place: Mumbai  
Date: July 22, 2022

**Sarah George**  
Partner  
Membership No: 045255

# Shareholder Information

## 1. Annual General Meeting

- Date and Time : 23<sup>rd</sup> August, 2022 at 03:00 p.m.
- Mode : Video conferencing (VC) /  
Other audio visual means (OAVM)

## 2. Financial Year

: 1<sup>st</sup> April, 2021 to 31<sup>st</sup> March, 2022

### Financial calendar

#### Board Meetings for approval of

- Financial results for the quarter ending June 30, 2022 : **Tentative Dates**  
: On or before 14<sup>th</sup> August, 2022
- Financial results for the half-year ending September 30, 2022 : On or before 14<sup>th</sup> November, 2022
- Financial results for the quarter ending December 31, 2022 : On or before 14<sup>th</sup> February, 2023
- Financial results for the year ending March 31, 2023 (Audited) : On or before 30<sup>th</sup> May, 2023
- Annual General Meeting for the year ended March 31, 2023 : On or before 31<sup>st</sup> August, 2023

## 3. Date of Book Closure

: 16<sup>th</sup> August, 2022 to 22<sup>nd</sup> August, 2022  
(Both days inclusive)

## 4. Dividend Payment Date

: On or after 23<sup>rd</sup> August, 2022

## 5. Registered Office

: Ahura Centre, 1st Floor,  
B Wing, Mahakali Caves Road  
Andheri (East), Mumbai - 400 093.  
Tel: (91-22) 66917000  
Fax: (91-22) 66917001  
E-Mail: hilinvestors@adityabirla.com  
Website: [www.hindalco.com](http://www.hindalco.com)  
CIN No. L27020MH1958PLC011238

## 6. a. Listing Details:

Equity Shares	Global Depository Receipts (GDRs)	Non-Convertible Debentures
<b>BSE Limited</b> Phiroze Jeejeebhoy Towers Dalal Street, Mumbai – 400 001.	Luxembourg Stock Exchange 35 A Boulevard Joseph II L-1840 Luxembourg	<b>National Stock Exchange of India Limited</b> "Exchange Plaza", Bandra Kurla Complex Bandra (East), Mumbai – 400 051.

**National Stock Exchange of India Limited**  
"Exchange Plaza",  
Bandra Kurla Complex  
Bandra (East), Mumbai – 400 051.

**Note:** Listing fees has been paid to all the Stock Exchanges as per their Schedule.

## b. Overseas Depository for GDRs

: J.P. Morgan Chase Bank N.A.  
P.O. Box 64504  
St. Paul, MN 55164-0504  
[jpmorgan.adr@eq-us.com](mailto:jpmorgan.adr@eq-us.com)

## c. Domestic Custodian of GDRs

: Citibank N.A.  
Custody Services  
FIFC, 11<sup>th</sup> Floor, C54 & 55, G Block, Bandra Kurla Complex,  
Bandra (East), Mumbai – 400 098  
Tel.: 91-22- 61756895  
Fax: 91-22-26532205

## 7. ISIN

: Fully paid up equity share: ISIN INE038A01020  
GDR: ISIN US4330641022  
CUSIP No. 433064300

## 8. Details of Debenture issued

Interest Payment Date	Interest	Series	Date of allotment	Tenure	Record Date	ISIN No.
25 <sup>th</sup> April*	Annually	9.55% Series (2012) –I	25 <sup>th</sup> April, 2012	10 Years	7 days prior to each interest and/or redemption payment	INE038807258
27 <sup>th</sup> June**	Annually	9.55% Series (2012) –II	27 <sup>th</sup> June, 2012	10 Years	7 days prior to each interest and/or redemption payment	INE038A07266
2 <sup>nd</sup> August	Annually	9.60% Series (2012)-III	2 <sup>nd</sup> August, 2012	10 Years	7 days prior to each interest and/or redemption payment	INE038A07274

\*Redeemed on 25<sup>th</sup> April, 2022

\*\*Redeemed on 27<sup>th</sup> June 2022

## 9. Stock Code

Stock Code:	Scrip Code	
BSE	500440	
NSE	HINDALCO	
Stock Exchange	Reuters	Bloomberg
BSE	HALC.BO	HNDL IN
NSE	HALC.NS	NHNDL IN
Luxembourg Stock Exchange (GDRs)	HALCg.LU	HDCD LI

## 10. Name and Address of Debenture Trustee

: IDBI Trusteeship Services Limited  
Asian Building, Ground Floor, 17 R. Kamani Marg  
Ballard Estate, Mumbai: 400 001

## 11. Stock Price Data

FY21	Bombay Stock Exchange				National Stock Exchange				Luxembourg Stock Exchange		
	High (In ₹)	Low	Close	Volume (In Nos)	High (In ₹)	Low	Close	Volume (In Nos)	High In US\$	Low	Close
Mar-22	636	556	570	1,14,56,711	636	556	570	30,74,53,768	8.35	7.25	7.50
Feb-22	580	488	574	68,08,232	580	488	574	21,08,69,448	7.60	6.65	7.60
Jan-22	516	472	489	49,95,283	516	472	489	14,26,12,734	6.85	5.00	6.55
Dec-21	477	419	476	54,33,420	477	416	476	18,02,98,872	6.40	5.55	6.40
Nov-21	485	407	412	87,88,385	482	407	413	20,22,35,880	6.45	5.50	5.50
Oct-21	552	454	460	1,17,62,709	552	453	460	21,14,21,877	7.30	6.15	6.15
Sep-21	504	439	488	1,56,99,756	504	439	488	22,90,22,037	6.65	6.05	6.60
Aug-21	471	400	468	89,45,151	471	400	468	27,71,50,969	6.40	5.41	6.40
Jul-21	461	373	444	1,24,82,674	474	372	445	24,67,25,196	6.11	2.88	5.96
Jun-21	405	360	372	1,21,73,865	406	360	372	26,16,40,840	5.46	3.08	4.96
May-21	428	358	394	2,08,11,470	428	358	394	48,94,48,369	5.76	3.48	5.41
Apr-21	377	329	364	1,42,03,903	377	328	364	37,23,59,454	4.96	4.27	4.89



# Shareholder Information

## 12. Stock Performance

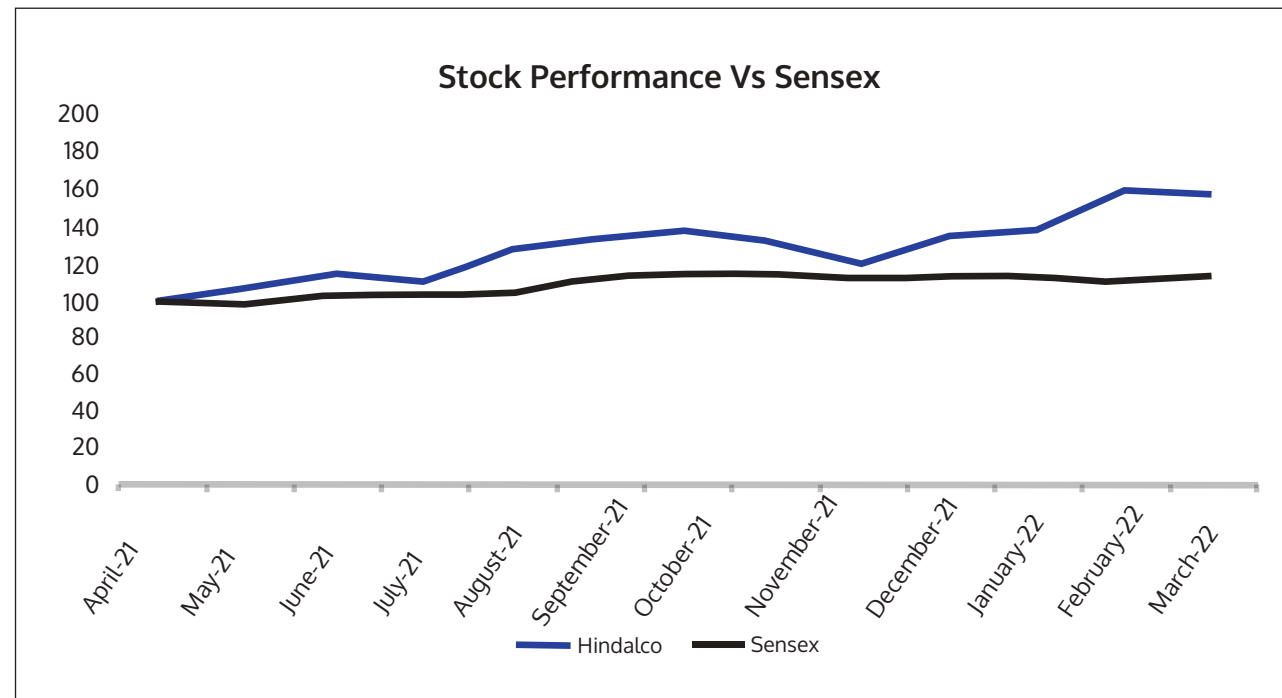

## 13. Stock Performance over the past few years

	Absolute Returns (in %)			Annualised Returns (in %)		
	1 YR	3 YR	5 YR	1 YR	3 YR	5 YR
Hindalco	74.27	177.18	192.03	74.27	40.47	23.90
SENSEX	18.30	51.45	97.73	18.30	14.84	14.61
NIFTY	18.88	50.25	90.38	18.88	14.53	13.74

## 14. Registrar and Transfer Agents

The Company has In-House Investors Service Department registered with SEBI as Category II Share Transfer Agent vide Registration no. INR 000003910.

**Investors Service Department**  
Hindalco Industries Limited  
Ahura Centre, 1<sup>st</sup> floor, B Wing  
Mahakali Caves Road  
Andheri (East), Mumbai - 400 093.  
Tel: (91-22) 6691 7000  
Fax: (91-22) 6691 7001  
E-mail: [hilinvestors@adityabirla.com](mailto:hilinvestors@adityabirla.com)

## 15. Share Transfer System

Share transfer in physical form are registered and returned within a period of 15 days of receipt, provided the documents are clear in all respects. Officers of the Company have been authorized to approve transfers up to 10,000 Shares in physical form under one transfer deed and one Director of the Company has been authorized to approve the transfers exceeding 10,000 shares under one transfer deed. As per directives issued by SEBI, it is compulsory to trade in the Company's equity shares in dematerialized form.

The total number of shares transferred in the physical form during the year was 1,40,019.

TRANSFER SUMMARY FROM 01-04-2021 TO 31-03-2022				
Transfer period in days		Number of Transfer	%	Number of Shares
FROM	TO			
0	10	122	99.18	1,62,646
11	15	1	0.82	103
16	20	-	-	-
<b>Total</b>		<b>123</b>	<b>100</b>	<b>1,62,749</b>

## 16. Investor Services

a. Complaints received during the year:

Nature of complaints	2021-2022		2020-2021	
	Received	Cleared	Received	Cleared
Relating to Transfers, Transmissions Dividend, Interest, Redemption, Demat – Remat, Rights Issue and Change of Address etc.	9	9	5	5

There are no complaints which are not resolved to the satisfaction of shareholder during the year

b. Shares pending for transfer : Nil

## 17. Distribution of Shareholding

DISTRIBUTION SCHEDULE AS ON MARCH 31, 2022						
Sr. No.	Shares From	Shares To	Shareholders	% of holder	No. of shares held	% of holding
1	0	1000	48,489	96.18	44,605,512	1.98
2	1001	2000	8,434	1.67	12,264,552	0.55
3	2001	5000	5,911	1.17	18,720,953	0.83
4	5001	10000	2,133	0.42	15,153,450	0.67
5	10001	50000	1,647	0.33	34,438,144	1.53
6	50001	100000	265	0.05	18,708,084	0.83
7	100001 and above		850	0.17	2,103,282,029	93.60
<b>Total</b>			<b>503,729</b>	<b>100</b>	<b>2,247,172,724</b>	<b>100</b>

## 18. Dematerialization of Shares and Liquidity

Around 98% of outstanding shares have been dematerialized. Trading in Hindalco Shares is permitted only in the dematerialized form 5<sup>th</sup> April, 1999 as per notification issued by Securities and Exchange Board of India.

## 19. Details on use of public funds obtained in 3 years

Not Applicable.

## 20. Outstanding GDR/Warrants/Convertible Bonds

9,82,70,986 GDRs are outstanding as on 31st March, 2022. Each GDR represents one underlying equity share.

# Shareholder Information

## 21. Commodity price risk or foreign exchange risk and hedging activities

Your Company hedges its foreign currency exposure in respect of its imports and exports as per its policies. Your Company has constituted a Risk Management Committee consisting of Directors/Executives of your Company. Your Company has commodity/foreign exchange hedging from time to time considering various factors as per the policy of the Company.

### Foreign Exchange Risk

Exchange rate movements, particularly the United States Dollar (USD) and Euro (EUR) against Indian Rupee (INR), have an impact on our operating results. In addition to the foreign exchange inflow from exports, the commodity prices in the domestic market are derived based on the landed cost of imports in India where LME prices and USD/INR exchange rate are the main factors. In case of conversion business, the objective is to match the exchange rate of outflows and related inflows through derivative financial instruments. With respect to Aluminium business where costs are predominantly in INR, the strengthening of INR against USD adversely affects the profitability of the business and benefits when INR depreciates against USD. The company enters into various foreign exchange contracts to protect profitability. The Company also enters into various foreign exchange contracts to mitigate the risk arising out of foreign currency exchange rate movement in foreign currency contracts executed with foreign suppliers to procure capital items for its project activities.

The details as required under SEBI (Listing Obligations & Disclosure Requirements) Regulations, 2015 is as below:

- 1 Risk management policy of the listed entity with respect to commodities including through hedging. The Company has a Risk Management Policy for Managing its Commodity Price Risk. The Policy captures the Objectives of Commodity Risk Management and the Treatment of Different Types of Exposures. The Policy lists down the Hedging Instruments that can be used, the Hedge Coverage ratios for different tenors and also mentions the Risk Management Structure at the Company.
- 2 Exposure of the listed entity to commodity and commodity risks faced by the entity throughout the year:
  - a Total Exposure of the listed entity to commodities mentioned in table below in INR in Millions : 995,672
  - b Exposure of the listed entity to various commodities:

Commodity Name	Nature of Risk (Physical)	UOM	Exposure in INR towards the particular commodity (₹ in Million)	Exposure in Quantity terms towards the particular commodity	% of such exposure hedged through commodity derivatives				
					Domestic Market		International Market		Total
					OTC	Exchange	OTC	Exchange	
Aluminium	Sell	MT	302,420	1,308,246	-	-	29	4	33
Furnace Oil/LSHS/LDO	Buy	MT	7,932	175,006	-	-	23	-	23
Copper	Buy	MT	293,909	414,864	-	-	26	9	35
Copper	Sell	MT	301,029	405,185	-	-	17	22	39
Silver (Oz)	Buy	T/Oz	4,655	2,732,752	-	-	100	-	100
Silver (Oz)	Sell	T/Oz	5,414	3,403,274	-	-	100	-	100
Gold (KG)	Buy	KG	39,508	9,112	-	99	-	-	99
Gold (KG)	Sell	KG	40,805	8,538	-	100	-	-	100

Note:

- 1 Table above includes Exposure and % Hedges for FY 2021-22 only. Details of hedges done for future years has not been captured here.
- 2 The table above includes commodities where a liquid derivative market exists.
- 3 The Company has price risk on commodities where an active derivative market does not exist, like Caustic Soda, Aluminum Fluoride, CP Coke, Alumina, Bauxite etc. These Commodities are not included in the table above.
- 4 The Company maintains offset hedge book to eliminate the "pricing" timing mismatch for buy and sell position of Copper, Silver and Gold. Accordingly, exposure of Copper, Buy position and Sell position naturally hedged is 50 % and 59 %, respectively. Accordingly, exposure of Gold, buy position naturally hedged is 1% . In case of Copper Buy exposure, 15% is not hedged represents unpriced transactions as at March 31, 2022 as the same will be hedged as and when they are priced, as per Company's policy. In case of copper sell exposure, 2% is unpriced transactions as at March 31, 2022 as the same will be hedged as and when they are priced, as per Company's policy.
- 5 The Company has strategic view based exposure for Copper, Gold and Silver. However, the same is not included above as it is a small portion of the overall Copper, Gold & Silver volumes.
- 6 The Company procures part of its Alumina requirement from its 100% subsidiary, Utkal Alumina International Limited. The same is not included in the above table.

- c The Company faces commodity price risk on purchase of its raw material as well as on sales of its products. The Company categorizes its price risk in broadly 2 categories - Offset Hedge Exposure and Strategic View Based Exposure. Under the Offset Hedge Program, we use derivative products to eliminate the price risk arising due to timing mismatch whereas for Strategic View Based exposure, derivative instruments are used to manage the price risk for future tenor. Hedging is done for commodities where an active derivative market exists.

## 22. Location of Plant and Mines

Aluminium & Power		
<b>Renukoot Plant*</b> P.O. Renukoot -231217 Dist Sonebhadra, Uttar Pradesh. Tel : (05446) 252077-9 Fax: (05446) 252107/426	<b>Renusagar Power Division</b> P. O. Renusagar, Dist. Sonebhadra, Uttar Pradesh. Tel:(05446)277161-3/ 278592-5 Fax: (05446) 277164/	<b>Hirakud Smelter</b> Hirakud 768 016 Dist: Sambalpur, Orissa Tel: (0663) 2481307/1452 Fax: (0663) 2481356
<b>Hirakud Power</b> Post Box No.12, Hirakud 768 016 Dist: Sambalpur, Orissa Tel: (0663) 2481307 Fax: (0663) 2481342/365 Fax: (0663) 2541642	<b>Mahan Aluminium</b> Hindalco Industries Limited NH-75 E, Singrauli, Sidhi Rd, P.O Bargawan, Pin:486886 Dist : Singrauli MP Tel : 0780-5281014	<b>Aditya Aluminium</b> Hindalco Industries Limited Lapanga, Dist Sambalpur-768212 Odisha Ph: 0663-2114424 Fax: 0663-2590434
Copper		Chemicals
<b>Birla Copper Division</b> P.O. Dahej, Lakhigam Dist. Bharuch – 392 130, Gujarat Tel: (02641) 256004/06, 251009 Fax: (02641) 251002	<b>Muri Alumina</b> Post Chotamuri-835 101 Dist: Ranchi, Jharkhand Phone: (06522) 244253/334 Fax: (06522) 244342	<b>Belagavi</b> Village Yamanapur Belgaum 590 010, Karnataka Tel: (0831) 2472716 Fax: (0831) 2472728
Sheet, Foil, Wheel, Packaging & Extrusions		
<b>Belur Sheet</b> 39, Grand Trunk Road Belurmath 711 202, Dist: Howrah West Bengal Tel: (033) 2654 7210/12 Fax: (033) 2654 9982/5740	<b>Taloja Sheet</b> Plot 2, MIDC Industrial Area Taloja A.V., Dist : Raigad Navi Mumbai - 410 208, Maharashtra Tel: (022) 2741 2261, 66292929 Fax: (022) 2741 2430/31	<b>Alapuram Extrusions</b> Alapuram, P.B. No.30 Kalamassery - 683 104 Dist: Ernakulam, Kerala Tel: (0484) 2532441-48 Fax: (0484) 2532468
<b>Mouda Unit</b> Village Dahali Ramtek Road, Mouda Nagpur – 441 1104 Tel: (07115) 660777/786	<b>Hirakud FRP</b> Hindalco Industries Limited Hirakud-768016 Dist- Sambhalpur, Odisha Tel: (0663) 6625000 Fax No(0663) 2481344	
Mines		
<b>Durgmanwadi Mines</b> At Post Radhanagri, Dist: Kolhapur, Maharashtra - 416 212 Tel: (02321) 2371008 Fax: (02321) 237478	<b>Lohardaga Mines</b> Dist: Lohardaga 835 302 Jharkhand Tel/ Fax: (06526) 224112	<b>Samari Mines</b> P.O: Kusumi 497222 Dist : Sarguja, Chattisgarh Tel/Fax(07778)274325
<b>Gare Palma Mines (IV/4 &amp; V/5)</b> Underground Coal Mines Village & Post Milupura Tehsil Tamnar Dist: Raigarh Chhattisgarh:496107	<b>Kathautia Coal Mine</b> Kathautia Open Cast Coal Mine (Koccm), Village Kathautia P.O Naudiha, PS Pandwa, Dist:Palamau Jharkhand:822123	<b>Dumri Coal Mine</b> 103, Commerce Tower Near Mahavir Tower, Main Road, Ranchi-834001 Tel: (0651) 2330944/48 Fax: (0651)2330782

\*Renukoot works has also manufacturing facilities of Chemicals, Sheets and Extrusions.



# Shareholder Information

## 23. Investor Correspondence

The Company Secretary  
Hindalco Industries Limited  
Ahura Centre, 1<sup>st</sup> Floor, B Wing  
Mahakali Caves Road, Andheri (E)  
Mumbai: 400093  
Tel: (91-22) 66917000  
Fax: (91-22) 66917001  
Email: hilinvestors@adityabirla.com

## 24. Categories of Shareholding (as on 31<sup>st</sup> March)

Category of Shareholders	2022				2021			
	Number of Share holders	% of share holders	Number of Shares held	% share holding	Number of Share Holders	% of share holders	Number of Shares held	% share holding
Promoter and Promoter Group*	17	0.00	7784,64,497	34.64	17	0.00	77,83,39,497	34.64
Mutual Funds & UTI	244	0.05	23,67,73,052	10.53	213	0.06	25,55,08,739	11.37
Banks/ Financial Institutions/ Ins/Govt	84	0.02	19,53,54,818	8.69	87	0.02	21,21,64,263	9.44
FIs	969	0.19	64,82,92,331	28.85	711	0.20	56,17,59,112	25.01
Corporates	2,644	0.53	11,71,86,478	5.21	1,776	0.51	12,34,13,264	5.49
Individuals/Shares In Transit/ Trust	4,88,882	97.05	14,08,19,886	6.27	3,38,181	97.05	13,39,25,040	5.97
NRIs/ OCBs/Foreign Nationals	10,887	2.16	3,94,87,988	1.76	7,484	2.16	3,92,80,733	1.75
GDRs	1	0.00	8,37,28,677	3.73	1	0.00	13,64,68,634	6.07
Shares held by Employee trust	1	0.00	70,64,997	0.31	1	0.00	58,24,965	0.26
<b>Total</b>	<b>5,03,729</b>	<b>100</b>	<b>2,24,71,72,724</b>	<b>100</b>	<b>3,48,471</b>	<b>100</b>	<b>2,24,66,84,247</b>	<b>100</b>

\*Includes 1,45,42,309 GDRs held by Promoter Group Companies.

## 25. Per share data

Particulars	2021-2022	2020-2021	2019-2020	2018-2019	2017-2018
Net Earnings (₹ in Crore)	5,507	993	620	1,205	1,436
Cash Earnings # (₹ in Crore)	7,354	2,841	2,328	2,899	3,053
Basic EPS (₹)	24.76	4.46	2.79	5.41	6.45
Cash EPS (₹) **	33.07	12.77	10.47	13.01	13.70
Dividend per share (₹)	4.00@	3.00	1.00	1.20	1.20
Dividend pay out (%)##	16.32@	67.88	36.23	26.92	22.58
Book Value per share (₹)	242.21	222.84	202.54	216.24	220.28
Price to earning (x)*	23.00	73.28	34.33	37.99	33.28
Price to cash earning (x) *	17.22	25.59	9.14	15.80	15.66
Price to Book Value (x) *	2.35	1.47	0.47	0.95	0.97

# Net Earnings plus Depreciation and Amortisation and Impairment Loss on Non-current Assets.

@ proposed dividend

\* Stock price as on 31<sup>st</sup> March

\*\* Cash EPS – Cash Earnings divided by weighted average numbers of equity shares used in computing basic EPS

## For calculation of dividend payout ratio of FY 2018-19, 2017-18 dividend includes Dividend Distribution Tax.

## 26. List of Credit Ratings

CARE ratings have provided the following ratings for the financial year 2021-2022

Instrument	Rating	Rating Action
Long Term Bank facilities-Term Loan	Care AA+/Stable	Reaffirmed
Long Term Bank facilities- Fund based WC Limits	Care AA+; Stable	Reaffirmed
Long Term / Short Term Bank Facilities- Non Fund based Working Capital Limit	CARE AA+; Stable / CARE A1+	Reaffirmed
Non Convertible Debenture	CARE AA+; Stable	Reaffirmed
Commercial Paper	CARE A1+	Reaffirmed

Crisil reaffirmed the Rating as CRISIL AA and revised its outlook from 'Stable' to 'Positive' on the non-convertible debentures on May 03, 2021. On July 29, 2021, Crisil upgraded rating on the non-convertible debentures to 'CRISIL AA+/Stable' from 'CRISIL AA/Positive'. Further, Crisil reaffirmed the rating as CRISIL A1+ for commercial paper.

## 27. Other useful information for shareholders

Shareholders who have not yet encashed their dividend warrants for the years 2014-2015 to 2020-2021 may approach the Company with a request letter quoting their Ledger Folio numbers / DP & Client ID along with dividend warrant(s) (if any) and a cancelled cheque leaf for revalidation/claim.

The details of Dividend paid by the Company and the respective due dates of transfer of unclaimed/un-encashed dividend to the designated fund of the Central Government is enumerated below:

Date of Declaration	Financial year of Dividend	Due date of transfer to the Government	Amount in ₹
September 16, 2015	2014-2015	October 23, 2022	55,73,225.49
September 14, 2016	2015-2016	October 21, 2023	55,36,865.00
September 13, 2017	2016-2017	October 20, 2024	63,92,367.50
September 21, 2018	2017-2018	October 27, 2025	68,17,914.00
August 30, 2019	2018-2019	October 7, 2026	64,83,313.80
September 10, 2020	2019-2020	October 21, 2027	50,85,182.00
August 23, 2021	2020-2021	October 1, 2028	1,29,03,167.00

Pursuant to the provisions of Investor Education and Protection Fund Authority (Accounting, Audit, Transfer and Refund) Rules 2016 read with Investor Education and Protection Fund Authority (Accounting, Audit, Transfer and Refund) Amendment 2017, the Company is mandated to transfer all such shares to Investor Education and Protection Fund (IEPF) in respect of which dividend has not been claimed for seven consecutive years or more.

The unclaimed dividend amount for the financial year 2013-2014 and 387767 Equity Shares related

to unclaimed dividend for the financial year have been credited to Investor Education and Protection Fund (IEPF). Shareholder can claim the unclaimed dividend amount.

Shareholder can claim the unclaimed dividend amounts and shares credited to IEPF with a separate application made to the IEPF Authority, in Form IEPF-5, as prescribed under the Rules and are available at IEPF website i.e. [www.iepf.gov.in](http://www.iepf.gov.in).

# Shareholder Information

## Share Transfer System

In terms of the provisions of Regulation 40(9) of the Listing Regulations, the Company has obtained, on yearly basis, a certificate, from a Company Secretary in Practice, certifying that all certificates have been issued within thirty days of the date of lodgement of the transfer (for cases lodged prior to 1st April, 2019), sub-division, consolidation and renewal and also filed a copy of the said certificate with the Stock Exchanges.

Request for rematerialisation are attended within the statutory period. The average time taken for processing and registration of relodged share transfer requests is less than 15 days. As on 31st March, 2022, there were no share transfer requests pending with the Company and there were no major legal proceedings relating to transfer of shares.

Shareholders may please note that SEBI vide its Circular No. SEBI/HO/MIRSD/MIRSD\_RTAMB/P/ CIR/2022/8 dated 25th January, 2022 has mandated the listed companies to issue securities in demat form only while processing service requests viz. issue of duplicate securities certificate; claim from Unclaimed Suspense Account; Renewal/ Exchange of securities certificate; Endorsement; Sub-division/ Splitting of securities certificate; Consolidation of securities certificates / folios; Transmission and Transposition. Accordingly, shareholders are requested to make service requests by submitting a duly filled and signed Form ISR – 4 (Form for various service requests), the format of which is available on the Company's website [www.hindalco.com](http://www.hindalco.com).

Shareholders holding equity shares of the Company in physical form are requested to kindly get their equity shares converted into demat/ electronic form to get inherent benefits of dematerialisation and also considering that physical transfer of equity shares/ issuance of equity shares in physical form have been disallowed by SEBI.

## Common and simplified norms for investor service request

In terms of the SEBI Circular No. SEBI/HO/ MIRSD/MIRSD\_RTAMB/P/CIR/2021/655 dated 3rd November, 2021, the Company had sent individual letters to all the shareholders holding shares of the Company in physical form for furnishing their PAN, KYC details and nomination. The shareholders are requested to go through the communication available on the Company's website [www.hindalco.com/investor-centre](http://www.hindalco.com/investor-centre).

## Nomination

As per the provisions of Section 72 of the Act, facility for making nomination(s) is available to Individuals holding shares in the Company. Shareholders holding shares in physical form may obtain a nomination form (Form SH-13), from the Company's Registered Office or download the same from the Company's website Company's website [www.hindalco.com/investor-centre](http://www.hindalco.com/investor-centre). Shareholders holding shares in demat mode should file their nomination with their DPs for availing this facility.

## Permanent Account Number

Shareholders who hold shares in physical form are advised that SEBI has vide Circular no. SEBI/HO/ MIRSD/MIRSD\_RTAMB/P/ CIR/2021/655 dated 3rd November, 2021 made it mandatory for all holders and claimants of physical securities to furnish PAN.

## Intimate / update contact details

Shareholders are requested to update / intimate changes, if any, pertaining to their PAN, postal address, e-mail address, telephone / mobile numbers, with necessary documentary evidence, to the Registered Office of the Company, in Form ISR-1, if shares are held in physical mode or to their Depository Participant ("DP"), if the holding is in electronic mode. The said form ISR-1 for change / update of details, form ISR-2 for bankers attestation of signature in case of major mismatch and form ISR-3 for declaration for opting out of nomination are available for download from the weblink <https://www.hindalco.com/investor-centre>.

## Freezing of Folios without PAN, KYC details and Nomination.

Folios wherein any one of the documents / details viz. PAN, KYC details and nomination are not available on or after 1st April, 2023, shall be frozen by the Company in terms of the aforementioned SEBI Circular. The frozen folios will be referred by the Company to the administering authority under the Benami Transactions (Prohibitions) Act, 1988 and or Prevention of Money Laundering Act, 2002, if they continue to remain frozen as on 31st December, 2025

In case of any query contact –  
Hindalco Industries limited  
Ahura Centre, 1<sup>st</sup> floor, B Wing  
Mahakali Caves Road  
Andheri (East),  
Mumbai- 400 093.  
Tel: (91-22) 6691 7000  
Fax: (91-22) 6691 7001  
Email ID: [hilinvestors@adityabirla.com](mailto:hilinvestors@adityabirla.com)

## Green Initiative in Corporate Governance – Service of Documents in Electronic Form

As you are aware, Ministry of Corporate Affairs Government of India (MCA) vide its Circular(s) Nos. 17 and 18 dated 21st April, 2011 and 29th April, 2011 respectively has now allowed the companies to send Notices of General Meetings/other Notices, Audited Financial Statements, Director's Report, Auditor's Report etc. henceforth to their shareholders electronically as a part of its Green Initiative in Corporate Governance.

Keeping in view the aforesaid green initiative of MCA, your Company shall send the Annual Report and other documents to its shareholders in electronic form at the e-mail address provided by them and made available to us by the Depository.

Further, in view of the outbreak of COVID-19 pandemic and owing to the difficulties involved in dispatching of physical copies of Annual Report, the Ministry of Corporate Affairs ("MCA") has vide its circular no 20/2020 dated 5 May 2020 and further circular no. FNO.Policy-17/57/2021-CL-MCA dated 05th May, 2022 directed the Companies to send the Annual Report only by e-mail to all the Members of the Company. Therefore, the Annual Report for FY 2021-22 and notice of AGM is being sent to the Members at their registered e-mail addresses in accordance with MCA and SEBI Circulars

## Unclaimed Shares in Physical Form

Regulation 39(4) of the Securities and Exchange Board of India (Listing Obligations and Disclosure Requirements) Regulations, 2015 provides the manner of dealing with shares issued in physical form pursuant to public issue or any other issue which remains unclaimed with the Company. In compliance with the provisions of Listing Regulations, the Company has sent three reminders to the shareholders whose share certificates are lying unclaimed.

Disclosures pursuant to Regulation 39(4) of Listing Regulation are as below:

- Aggregate number of shareholders and outstanding shares lying in Unclaimed Suspense Account as at 31st March, 2022
  - Nil shareholders holding Nil Equity Shares.
  - Nil Equity Shares in physical form for transmission/deletion.
  - Nil Equity Shares in physical form includes above mentioned Nil Equity Shares.

## Other Information

(i) Equity Shares of the Company are under compulsory demat trading by all investors, with effect from April 05, 1999. Considering the advantages of scrip less trading, shareholders are requested to consider dematerialization of their shareholding so as to avoid inconvenience in future.

BSE has vide circular dated July 05, 2018 informed about amendment to Regulation 40 of Listing Regulations mandating the transfer of securities would be carried out in dematerialised form only. This restriction shall not be applicable to the request received for Deletion, Transmission or Transposition of physical shares.

(ii) Shareholders/Beneficial Owners are requested to quote their Folio No./DP & Client ID Nos., as the case may be, in all correspondence with the Company. All correspondences regarding shares & debentures of the Company should be addressed to the Investor Service Department of the Company at Ahura Centre, 1st Floor, 'B' Wing, Mahakali Caves Road, Andheri (East), Mumbai - 400 093 and not to any other office(s) of the Company.

(iii) Shareholders holding shares in physical form are requested to notify to the Company, change in their address/Pin Code number and Bank Account details promptly by written request under the signatures of sole / first joint holder. Beneficial Owners of shares in demat form are requested to send their instructions regarding change of name, change of address, bank details, nomination, power of attorney, etc. directly to their DP.

(iv) To prevent fraudulent encashment of dividend warrants, members are requested to provide their Bank Account Details (if not provided earlier) to the Company (if shares are held in physical form) or to DP (if shares are held in demat form), as the case may be, for printing of the same on their dividend warrants.

(v) Non-resident members are requested to immediately notify:-

- o change in their residential status on return to India for permanent settlement;
- o particulars of their NRE Bank Account with a bank in India, if not furnished earlier.

(vi) In case of loss/misplacement of share certificate, investors should immediately lodge a FIR/Complaint with the police



## Shareholder Information

and inform to Company along with original or certified copy of FIR/acknowledged copy of the complaint.

- (vii) Shareholders are requested to keep record of their specimen signature before lodgment of shares with the Company to obviate possibility of difference in signature at a later date.
- (viii) Shareholders(s) of the Company who have multiple accounts in identical name(s) or holding more than one Share Certificates in the same name under different

Ledger Folio(s) are requested to apply for consolidation of such Folio(s) and send the relevant Share Certificates to the Company.

- (ix) Shareholders are requested to give us their valuable suggestions for improvement of our investor services.
- (x) Shareholders are requested to quote their E-mail Ids, Telephone/Fax numbers for prompt reply to their communication.

## Financial Statements

---

274	Independent Auditor's Report on the Consolidated Financial Statements
286	Consolidated Balance Sheet
288	Consolidated Statement of Profit and Loss
290	Consolidated Statement of Changes in Equity
292	Consolidated Statement of Cash Flows
294	Notes forming part of the Consolidated Financial Statements
443	Independent Auditor's Report on the Standalone Financial Statements
458	Standalone Balance Sheet
460	Standalone Statement of Profit and Loss
462	Standalone Statement of Changes in Equity
464	Standalone Statement of Cash Flows
466	Notes forming part of the Standalone Financial Statements
582	Independent Assurance Statement on Integrated Report

# Independent Auditor's Report

## on the Consolidated Financial Statements

To the Members of Hindalco Industries Limited

Report on the Audit of the Consolidated Financial Statements

### Opinion

- We have audited the accompanying consolidated financial statements of Hindalco Industries Limited (hereinafter referred to as the "Holding Company") which includes the financial statements/financial information in respect of joint operations consolidated on a proportionate basis, trusts and subsidiaries (Holding Company, joint operations, trusts and subsidiaries together referred to as "the Group"), its joint ventures and associate companies (refer Note 48 to the attached consolidated financial statements), which comprise the Consolidated Balance Sheet as at March 31, 2022, and the Consolidated Statement of Profit and Loss (including Other Comprehensive Loss), the Consolidated Statement of Changes in Equity and the Consolidated Statement of Cash Flows for the year then ended, and notes to the consolidated financial statements, including a summary of significant accounting policies and other explanatory information (hereinafter referred to as "the consolidated financial statements").
- In our opinion and to the best of our information and according to the explanations given to us and based on the consideration of reports of other auditors on separate audited financial statements /consolidated audited financial information of the joint operations, subsidiaries, joint venture and associate companies, and based on the consideration of the separate unaudited financial information of the trusts, subsidiaries and joint venture, the aforesaid consolidated financial statements give the information required by the Companies Act, 2013 ("the Act") in the manner so required and give a true and fair view in conformity with the accounting principles generally accepted in India, of the consolidated state of affairs of the Group, its joint ventures and associate companies as at March 31, 2022, of the consolidated total

comprehensive income (comprising of profit and other comprehensive loss), consolidated changes in equity and its consolidated cash flows for the year then ended.

### Basis for Opinion

- We conducted our audit in accordance with the Standards on Auditing (SAs) specified under Section 143(10) of the Act. Our responsibilities under those Standards are further described in the 'Auditor's Responsibilities for the Audit of the Consolidated Financial Statements' section of our report. We are independent of the Group, its joint ventures, and associate companies in accordance with the ethical requirements that are relevant to our audit of the consolidated financial statements in India in terms of the Code of Ethics issued by the Institute of Chartered Accountants of India and the relevant provisions of the Act, and we have fulfilled our other ethical responsibilities in accordance with these requirements. We believe that the audit evidence we have obtained, and the audit evidence obtained by the other auditors in terms of their reports referred to in sub-paragraph 16 of the Other Matters paragraph below, other than the unaudited financial information as certified by the management and referred to in sub-paragraph 17 of the Other Matters section below, is sufficient and appropriate to provide a basis for our opinion.

### Key Audit Matters

- Key audit matters are those matters that, in our professional judgment, were of most significance in our audit of the consolidated financial statements of the current period. These matters were addressed in the context of our audit of the consolidated financial statements as a whole, and in forming our opinion thereon, and we do not provide a separate opinion on these matters.

Key Audit Matter	How our audit addressed the Key Audit Matter
<p><b>A. Measurement of inventory quantities of coal, bauxite, copper concentrate and work in progress consisting of precious metals</b></p> <p>Refer Notes 1D (l) and 11 (d) to the consolidated financial statements.</p> <p>Of the Holding Company's ₹ 20,948 crores of inventory as at March 31, 2022, ₹ 4,302 crores of inventory comprised of coal, bauxite, copper concentrate and work in progress consisting of precious metals.</p> <p>This was determined a key audit matter, as the measurement of these inventory quantities lying at the Holding Company's yards, smelters and refineries is complex and involves significant judgement and estimate resulting from measuring the surface area, dip measurement of materials in tanks/silos and other parameters.</p>	<p>Our audit procedures relating to the measurement of inventory quantities of coal, bauxite, copper concentrate and work in progress of precious metals included the following:</p> <ul style="list-style-type: none"> <li>Understanding and evaluating the design and testing the operating effectiveness of controls over the physical count process and measurement of such inventory;</li> <li>Evaluation of the independence competency and capabilities of the management's experts;</li> <li>Physically observing inventory measurement and count procedures carried out by management using experts, to assess its appropriateness and completeness and performing roll forward procedures; and</li> </ul>

Key Audit Matter	How our audit addressed the Key Audit Matter
<p>The Holding Company uses internal and external experts, as applicable to perform volumetric surveys and assessments, basis which the quantities of these inventories are estimated.</p>	<ul style="list-style-type: none"> <li>Obtaining and inspecting inventory measurement and physical count results for such inventories, including assessing and evaluating the results of analysis performed by management in respect of differences between book and physical quantities.</li> </ul> <p>Based on the above procedures performed, we did not identify any material exceptions in the measurement of inventory quantities of coal, bauxite, copper concentrate and work in progress inventories consisting of precious metals.</p>
<p><b>B. Provisions recognised and contingencies disclosed with regard to certain legal and tax matters including uncertain tax positions.</b></p> <p>Refer Notes 1D (k), 9C, 10, 22 and 43 to the consolidated financial statements.</p> <p>The Holding Company operate in a Complex tax jurisdiction with certain tax exemption/deduction that may be subject to challenge and audit by the tax authorities. There are open tax matters under litigation with tax authorities.</p> <p>As at March 31, 2022, the Holding Company has, recognised provisions and disclosed contingent liabilities towards various legal and tax matters. There are number of legal, direct and indirect tax cases against the Holding Company, including environmental, mining, local and state levies, income tax holidays, availing of input tax credits and such other matters.</p> <p>This is a key audit matter, as evaluation of these matters requires management judgement and estimation, related legal advice including those leading to interpretation of laws and regulations and application of relevant judicial precedents to determine the probability of the outflow of economic resources for recognising provisions, disclosing contingent liabilities and making related disclosures in the consolidated financial statements.</p>	<p>Our audit procedures relating to provisions recognised and contingencies disclosed with regard to certain legal and tax matters included the following:</p> <ul style="list-style-type: none"> <li>Understanding and evaluating the design and testing the operating effectiveness of controls over the recognition, measurement, presentation and disclosures made in the consolidated financial statements in respect of these matters;</li> <li>Obtaining details of legal and tax matters, inspecting the supporting documents to evaluate management's assessment of probability of outcome and the magnitude of potential loss, and testing related to provisions and disclosures in the consolidated financial statements through inquiries with the management and legal counsel;</li> <li>Assessing on test basis on the underlying calculation supporting the contingent liability and other litigations disclosures in the consolidated financial statements;</li> <li>Reviewing orders and other communication from tax and regulatory authorities and management responses thereto;</li> <li>Assessing the management expert's legal advice and opinion as applicable, obtained by the Holding Company's management to corroborate management assessment and evaluating competence and capabilities of the experts; and</li> <li>Using auditor's specialist for technical assessment assistance in evaluating certain significant and judgemental complex direct and indirect tax litigation and positions in tax returns and their possible outcome.</li> </ul> <p>Based on the above procedures performed, we did not identify any material exceptions in the provisions recognised and contingent liabilities disclosed in the consolidated financial statements with regard to such legal and tax matters.</p>



# Independent Auditor's Report

## on the Consolidated Financial Statements

Key Audit Matter	How our audit addressed the Key Audit Matter
<p><b>C. Accounting of derivatives and hedging transactions</b></p> <p>Refer Notes 1B(R) and 46 to the consolidated financial statements.</p> <p>Holding Company's financial performance is significantly impacted by fluctuations in prices of aluminium, copper, gold, silver, furnace oil and foreign exchange rates. The Holding Company takes a structured approach to the identification, quantification and hedging of such risks by using various derivatives (e.g. forwards, futures, options and embedded derivatives) in commodities and/or foreign currencies. These hedges are designated as either cash flow or fair value hedges, and in certain cases remains non-designated.</p> <p>As at March 31, 2022, the carrying value of the Holding Company's derivatives included derivative assets amounting to ₹ 681 crores and derivative liabilities amounting to ₹ 3,763 crores.</p> <p>Derivative and hedge accounting is considered a key audit matter, because of its significance to the consolidated financial statements, the volume, nature and types of hedging relationships, including complexity involved in the application of hedge accounting principles in accordance with Ind AS 109, Financial Instruments.</p>	<p>Our audit procedures related to accounting of derivatives and hedging transactions included the following:</p> <ul style="list-style-type: none"> <li>Understanding and evaluating the design and testing the operating effectiveness of controls over accounting of derivatives and hedging transactions;</li> <li>Testing qualifying criteria for hedge accounting in accordance with Ind AS 109, including:                             <ul style="list-style-type: none"> <li>✓ Understanding the risk management objectives and strategies for different types of hedging programs;</li> <li>✓ Evaluating that the hedging relationship consists only of eligible hedging instruments and hedged items;</li> <li>✓ Using auditor's expert for assistance in verifying hedge effectiveness requirements of Ind AS 109, Financial Instruments, including the economic relationship between the hedged item and the hedging instrument.</li> </ul> </li> <li>Testing appropriateness of hedge accounting to qualified hedge relationships i.e. cash flow and fair value hedges; and</li> <li>Testing related presentation and disclosures in the consolidated financial statements.</li> </ul> <p>Based on the above procedures performed, we did not identify any material exceptions in the amounts, presentation and disclosures made in the consolidated financial statements relating to accounting of derivatives and hedging transactions.</p>

5. The following Key Audit Matter was included in the Memorandum of Work Performed issued by other auditor whose audit report dated May 24, 2022, contained an unmodified audit opinion on the consolidated financial information of Novelis Inc. ("Novelis"), a subsidiary of the Holding Company, which is reproduced by us as under:

Key Audit Matter	How the other auditor addressed the Key Audit Matter
<p><b>Goodwill impairment assessment</b></p> <p>The Company's consolidated goodwill balance was ₹ 23,915 crores as of March 31, 2022. Management conducts an impairment test as of the last day of March of each year, or more frequently if events or circumstances indicate that the carrying value of goodwill may be impaired. As disclosed by management, potential impairment is identified by comparing the recoverable value of each cash generating unit to its carrying value. The Company estimates the recoverable value based on fair value less costs to sell approach. If the carrying value exceeds the recoverable value, management records an impairment charge in an amount equal to that excess. The determination of recoverable value using the market and income approaches requires the use of management's significant assumptions related to selection of market multiples and control premium for the market approach and sales volumes, conversion premium, capital spending, working capital changes and the discount rate for the income approach.</p>	<p>Addressing the matter involved performing procedures and evaluating audit evidence in connection with forming our overall opinion on the consolidated financial information. Our procedures included, among others:</p> <ul style="list-style-type: none"> <li>(i) Understanding and evaluating the design and testing the effectiveness of controls relating to management's goodwill impairment assessment, including controls over the valuation of the Company's cash generating units;</li> <li>(ii) Testing management's process for developing the fair value estimate of the cash generating units;</li> <li>(iii) Evaluating the appropriateness of the income and market approaches and the weighting of the approaches;</li> <li>(iv) Testing the completeness and accuracy of underlying data used in the approaches;</li> <li>(v) Evaluating the reasonableness of the significant assumptions used by management in the income and market approaches;</li> </ul>

Key Audit Matter	How the other auditor addressed the Key Audit Matter
<p>The principal considerations for our determination that performing procedures relating to the goodwill impairment assessment is a Key Audit Matter are (i) the significant judgment by management when developing the fair value measurement of the cash generating units; (ii) a high degree of auditor judgment, subjectivity, and effort in performing procedures and evaluating management's significant assumptions related to market multiples and control premium for the market approach and sales volumes, conversion premium, capital spending and the discount rate for the income approach; and (iii) the audit effort involved the use of professionals with specialized skill and knowledge.</p> <p>Refer Notes 14 and 42 in the consolidated financial information of Novelis.*</p>	<p>(vi) Evaluating management's assumptions related to sales volumes and prices, costs to produce, and capital spending involved evaluating whether the assumptions used by management were reasonable considering (i) the current and past performance of the cash generating units; (ii) the consistency with external market and industry data; and (iii) whether these assumptions were consistent with evidence obtained in other areas of the audit; and</p> <p>(vii) Professionals with specialized skill and knowledge were used to assist in evaluating the appropriateness of the income and market approaches, the weighting of the approaches, and evaluating the reasonableness of the discount rate, control premium and market multiples assumptions.</p> <p>As a result of our procedures performed, no misstatements were noted.</p>

\* These notes are included in Note 1(D) (b) and 4 of the consolidated financial statements

6. The following Key Audit Matter was included in the Memorandum of Work Performed issued by an independent firm of Chartered Accountants along with their audit report dated May 17, 2022, which contained an unmodified audit opinion on the financial statements of Utkal Alumina International Limited ("Utkal"), a subsidiary of the Holding Company, which has been reproduced by us as under:

Key Audit Matter	How the other auditor addressed the Key Audit Matter
<p><b>Valuation of deferred tax assets, including recognised Minimum Alternate Tax (MAT) credit</b></p> <p>The Company has significant amount of deferred tax assets, mainly resulting from carry forward unabsorbed depreciation and MAT credit as per Income Tax Act. The valuation of deferred tax assets including MAT is significant to our audit because the risk exists that future taxable profits will not be sufficient to fully recover the deferred tax assets including MAT credit. Management supports the recoverability of the deferred tax assets mainly with income projections which contain estimates of and tax strategies for future taxable income.</p> <p>Refer Notes 9 &amp; 36* of Utkal's financial statements.</p>	<p>Our audit procedures included:</p> <ul style="list-style-type: none"> <li>Evaluating the management's determination of the estimated manner in which the deferred tax asset would be utilised by comparing the management's assessment to business plans and long term profit forecasts and the key assumptions used in the projections based on our knowledge of the business and the industry in which the Company operates;</li> <li>Critically assessing whether profit forecasts are reasonable in relation to historical trends, current year performance and future plans;</li> <li>We also reperformed the calculation of deferred taxes, checking that the tax rate applied is proper. We compared the tax plans with the Company's budget on a sample basis in terms of the recoverability of deferred tax assets from temporary differences and from carried forwards of unabsorbed depreciation and MAT credit;</li> <li>Using our own tax team to assist us in assessing the appropriateness of the level of deferred taxes recognised in the balance sheet; and</li> <li>We assessed the adequacy of the income tax disclosures to the financial statements, setting out the basis of the deferred tax balance and the level of estimation involved.</li> </ul> <p>Our audit procedures did not lead to any reservations regarding the recognition, measurement and disclosure of deferred taxes.</p>

\* These notes are included in Note 9 of the consolidated financial statements.

# Independent Auditor's Report

## on the Consolidated Financial Statements

### Other Information

7. The Holding Company's Board of Directors is responsible for the other information. The other information comprises the information included in the annual report but does not include the consolidated financial statements and our and other auditor's report thereon. The annual report is expected to be made available to us after the date of this auditor's report.

Our opinion on the consolidated financial statements does not cover the other information and we will not express any form of assurance conclusion thereon.

In connection with our audit of the consolidated financial statements, our responsibility is to read the other information identified above when it becomes available and, in doing so, consider whether the other information is materially inconsistent with the consolidated financial statements or our knowledge obtained in the audit, or otherwise appears to be materially misstated.

When we read the annual report, if we conclude that there is a material misstatement therein, we are required to communicate the matter to those charged with governance and take appropriate action as applicable under the relevant laws and regulations

### Responsibilities of Management and Those Charged with Governance for the consolidated financial statements

8. The Holding Company's Board of Directors is responsible for the preparation and presentation of these consolidated financial statements in term of the requirements of the Act that give a true and fair view of the consolidated financial position, consolidated financial performance and consolidated cash flows, and changes in equity of the Group including, joint ventures and associate companies in accordance with the accounting principles generally accepted in India, including the Accounting Standards specified under Section 133 of the Act. The respective Board of Directors of the companies included in the Group and of its joint ventures and associate companies are responsible for maintenance of adequate accounting records in accordance with the provisions of the Act for safeguarding the assets of the Group and of its joint ventures and associate companies and for preventing and detecting frauds and other irregularities; selection and application of appropriate accounting policies; making judgments and estimates that are reasonable and prudent; and the design, implementation and maintenance of adequate internal financial controls, that were operating effectively for ensuring accuracy and completeness of the accounting records, relevant to the preparation and presentation of the consolidated financial statements that give a true and fair view and are free from material misstatement, whether due to fraud or error, which have been used for the purpose of preparation

of the consolidated financial statements by the Directors of the Holding Company, as aforesaid.

9. In preparing the consolidated financial statements, the respective Board of Directors of the companies included in the Group and of its joint ventures and associate companies are responsible for assessing the ability of the Group and of its joint ventures and associate companies to continue as a going concern, disclosing, as applicable, matters related to going concern and using the going concern basis of accounting unless the respective Board of Directors either intends to liquidate the Group and its joint ventures and associate companies or to cease operations, or has no realistic alternative but to do so.
10. The respective Board of Directors of the companies included in the Group and of its joint ventures and associate companies are responsible for overseeing the financial reporting process of the Group and of its joint ventures and associate companies.

### Auditor's Responsibilities for the Audit of the Consolidated Financial Statements

11. Our objectives are to obtain reasonable assurance about whether the consolidated financial statements as a whole are free from material misstatement, whether due to fraud or error, and to issue an auditor's report that includes our opinion. Reasonable assurance is a high level of assurance but is not a guarantee that an audit conducted in accordance with SAs will always detect a material misstatement when it exists. Misstatements can arise from fraud or error and are considered material if, individually or in the aggregate, they could reasonably be expected to influence the economic decisions of users taken on the basis of these consolidated financial statements.
12. As part of an audit in accordance with SAs, we exercise professional judgment and maintain professional scepticism throughout the audit. We also:
  - Identify and assess the risks of material misstatement of the consolidated financial statements, whether due to fraud or error, design and perform audit procedures responsive to those risks, and obtain audit evidence that is sufficient and appropriate to provide a basis for our opinion. The risk of not detecting a material misstatement resulting from fraud is higher than for one resulting from error, as fraud may involve collusion, forgery, intentional omissions, misrepresentations, or the override of internal control.
  - Obtain an understanding of internal control relevant to the audit in order to design audit procedures that are appropriate in the circumstances. Under Section 143(3)(i) of the Act, we are also responsible for expressing our opinion on whether the Holding

Company has adequate internal financial controls with reference to consolidated financial statements in place and the operating effectiveness of such controls.

- Evaluate the appropriateness of accounting policies used and the reasonableness of accounting estimates and related disclosures made by the Board of Directors.
  - Conclude on the appropriateness of the Board of Directors use of the going concern basis of accounting and, based on the audit evidence obtained, whether a material uncertainty exists related to events or conditions that may cast significant doubt on the ability of the Group and its joint ventures and associate companies to continue as a going concern. If we conclude that a material uncertainty exists, we are required to draw attention in our auditor's report to the related disclosures in the consolidated financial statements or, if such disclosures are inadequate, to modify our opinion. Our conclusions are based on the audit evidence obtained up to the date of our auditor's report. However, future events or conditions may cause the Group and its joint ventures and associate companies to cease to continue as a going concern.
  - Evaluate the overall presentation, structure and content of the consolidated financial statements, including the disclosures, and whether the consolidated financial statements represent the underlying transactions and events in a manner that achieves fair presentation.
  - Obtain sufficient appropriate audit evidence regarding the financial information of the entities or business activities within the Group and its joint ventures and associate companies to express an opinion on the consolidated financial statements. We are responsible for the direction, supervision and performance of the audit of the financial statements of such entities included in the consolidated financial statements of which we are the independent auditors. For the other entities included in the consolidated financial statements, which have been audited by other auditors, such other auditors remain responsible for the direction, supervision and performance of the audits carried out by them. We remain solely responsible for our audit opinion.
13. We communicate with those charged with governance of the Holding Company and such other entities included in the consolidated financial statements of which we are the independent auditors regarding, among other matters, the planned scope and timing of the audit and significant audit findings, including any significant deficiencies in

internal control that we identify during our audit.

14. We also provide those charged with governance with a statement that we have complied with relevant ethical requirements regarding independence, and to communicate with them all relationships and other matters that may reasonably be thought to bear on our independence, and where applicable, related safeguards.
15. From the matters communicated with those charged with governance, we determine those matters that were of most significance in the audit of the consolidated financial statements of the current period and are therefore the key audit matters. We describe these matters in our auditor's report unless law or regulation precludes public disclosure about the matter or when, in extremely rare circumstances, we determine that a matter should not be communicated in our report because the adverse consequences of doing so would reasonably be expected to outweigh the public interest benefits of such communication.

### Other Matters

16. We did not audit the financial statements of ten subsidiaries, consolidated financial information of one subsidiary and financial statements of two joint operations included in the consolidated financial statements of the Holding Company, which constitute total assets of ₹ 141,194 crores and net assets of ₹ 40,434 crores as at March 31, 2022, total revenue from operations of ₹ 130,751 crores, total comprehensive income (comprising of profit after tax and other comprehensive loss) of ₹ 7,851 crores and net cash inflows amounting to ₹ 561 crores for the year ended on that date. The consolidated financial statements also include the Group's share of total comprehensive income (comprising of profit after tax and other comprehensive income) of ₹ 6 crores for the year ended March 31, 2022 as considered in the consolidated financial statements, in respect of one joint venture and four associate companies, whose financial statements have not been audited by us. These financial statements/ consolidated financial information have been audited by other auditors whose reports have been furnished to us by the Management/other auditors and our opinion on the consolidated financial statements insofar as it relates to the amounts and disclosures included in respect of these subsidiaries, joint operations, joint venture and associate companies and our report in terms of sub-section (3) of Section 143 of the Act including report on Other Information insofar as it relates to the aforesaid subsidiaries, joint operations, joint venture and associate companies, is based solely on the reports of the other auditors. Material uncertainty related to going concern has been reported by two joint operations and one subsidiary during the year which are not material to the Group.



# Independent Auditor's Report

## on the Consolidated Financial Statements

17. We did not audit the financial information of three subsidiaries and two trusts included in the consolidated financial statements of the Holding Company, which constitute total assets of ₹ 250 crores and net assets of ₹ 32 crores as at March 31, 2022, total revenue from operations of ₹ 287 crores, total comprehensive loss (comprising of loss after tax and other comprehensive income) of ₹ 13 crores and net cash inflows amounting to ₹ 175 crores for the year ended on that date. The consolidated financial statements also include the Group's share of total comprehensive income (comprising of profit after tax and other comprehensive income) of ₹ Nil for the year ended March 31, 2022 as considered in the consolidated financial statements, in respect of one joint venture, whose financial information have not been audited by us. These financial information are unaudited and have been furnished to us by the Management, and our opinion on the consolidated financial statements insofar as it relates to the amounts and disclosures included in respect of these subsidiaries, trusts and joint venture and our report in terms of sub-section (3) of Section 143 of the Act including report on Other Information insofar as it relates to the aforesaid subsidiaries, trusts and joint venture is based solely on such unaudited financial information. In our opinion and according to the information and explanations given to us by the Management, these financial information are not material to the Group.

Our opinion on the consolidated financial statements, and our report on Other Legal and Regulatory Requirements below, is not modified in respect of the above matters with respect to our reliance on the work done and the reports of the other auditors and the financial statements/ financial information certified by the Management.

### Report on Other Legal and Regulatory Requirements

18. As required by the Companies (Auditor's Report) Order, 2020 ("CARO 2020"), issued by the Central Government of India in terms of sub-section (11) of Section 143 of the Act, we give in the "Annexure A", a statement on the matter specified in paragraph 3(xxi) of CARO 2020.
19. As required by Section 143(3) of the Act, we report, to the extent applicable, that:
- We have sought and obtained all the information and explanations which to the best of our knowledge and belief were necessary for the purposes of our audit of the aforesaid consolidated financial statements.
  - In our opinion, proper books of account as required by law relating to preparation of the aforesaid consolidated financial statements have been kept so far as it appears from our examination of those books and the reports of the other auditors.
  - The Consolidated Balance Sheet, the Consolidated Statement of Profit and Loss (including other

comprehensive loss), the Consolidated Statement of Changes in Equity and the Consolidated Statement of Cash Flows dealt with by this Report are in agreement with the relevant books of account and records maintained for the purpose of preparation of the consolidated financial statements.

- In our opinion, the aforesaid consolidated financial statements comply with the Accounting Standards specified under Section 133 of the Act.
- On the basis of the written representations received from the directors of the Holding Company as on March 31, 2022 taken on record by the Board of Directors of the Holding Company and the reports of the statutory auditors of its joint operations, its subsidiary companies, joint venture and associate companies incorporated in India, none of the directors of the Holding Company, its joint operations, its subsidiary companies, its joint venture and associate companies incorporated in India is disqualified as on March 31, 2022 from being appointed as a director in terms of Section 164(2) of the Act.
- With respect to the adequacy of internal financial controls with reference to consolidated financial statements of the Holding Company, joint operations, subsidiaries, joint venture and associate companies incorporated in India and the operating effectiveness of such controls, refer to our separate report in "Annexure B".
- With respect to the other matters to be included in the Auditor's Report in accordance with Rule 11 of the Companies (Audit and Auditor's) Rules, 2014, in our opinion and to the best of our information and according to the explanations given to us:
  - The consolidated financial statements disclose the impact of pending litigations on the consolidated financial position of the Group, its joint ventures and associate companies— Refer Note 22, 9C and 43 to the consolidated financial statements.
  - Provision has been made in the consolidated financial statements, as required under the applicable law or accounting standards, for material foreseeable losses, if any, on long-term contracts including derivative contracts as at March 31, 2022— Refer Note 22 and 46 to the consolidated financial statements in respect of such items as it relates to the Group, its joint ventures and associate companies.
  - Except as referred to in Note 21B to the consolidated financial statements, there has been no delay in transferring amounts required to be transferred to the Investor Education and

Protection Fund by the Holding Company, its joint operations, subsidiary companies, joint venture and associate companies incorporated in India during the year.

- The respective Managements of the Holding Company, joint operations, subsidiaries, joint venture and associate companies which are companies incorporated in India whose financial statements have been audited under the Act have represented to us and the other auditors of such joint operations, subsidiaries, joint venture and associate companies respectively that, to the best of their knowledge and belief, other than as disclosed in the notes to the accounts, no funds (which are material either individually or in the aggregate) have been advanced or loaned or invested (either from borrowed funds or share premium or any other sources or kind of funds) by the Holding Company or any of such joint operations, subsidiaries, joint venture and associate companies to or in any other persons or entities, including foreign entities ("Intermediaries"), with the understanding, whether recorded in writing or otherwise, that the Intermediary shall, directly or indirectly, lend or invest in other persons or entities identified in any manner whatsoever by or on behalf of the Holding Company or any of such joint operations, subsidiaries, joint venture and associate companies ("Ultimate Beneficiaries") or provide any guarantee, security or the like on behalf of the Ultimate Beneficiaries (Refer Note 53(C) to the consolidated financial statements);
- The respective Managements of the Holding Company, joint operations, subsidiaries, joint venture and associate companies which are companies incorporated in India whose financial statements have been audited under the Act have represented to us and the other auditors of such joint operations, subsidiaries, joint venture and associate companies respectively that, to the best of their knowledge and belief, other than as disclosed in the notes to the accounts, no funds (which are material either individually or in the aggregate) have been received by the Holding Company or any of such joint operations, subsidiaries, joint venture and associate companies from any persons or entities, including

foreign entities ("Funding Parties"), with the understanding, whether recorded in writing or otherwise, that the Holding Company or any of such joint operations, subsidiaries, joint venture and associate companies shall, directly or indirectly, lend or invest in other persons or entities identified in any manner whatsoever by or on behalf of the Funding Party ("Ultimate Beneficiaries") or provide any guarantee, security or the like on behalf of the Ultimate Beneficiaries (Refer Note 53(C) to the consolidated financial statements).

- Based on the audit procedures, that has been considered reasonable and appropriate in the circumstances, performed by us and those performed by the auditors of the joint operations, subsidiaries, joint venture and associate companies which are companies incorporated in India whose financial statements have been audited under the Act, nothing has come to our or other auditor's notice that has caused us or the other auditors to believe that the representations under sub-clause (i) and (ii) of Rule 11(e) of the Companies (Audit and Auditors) Rules, 2014 contain any material misstatement.
  - The dividend declared and paid during the year by the Holding Company, and two associate companies is in compliance with Section 123 of the Act. The joint operations, subsidiary companies, three associate companies and joint venture has not declared or paid any dividend during the year.
20. The Holding Company and its joint operations, subsidiary companies, joint venture and associate companies incorporated as public companies in India have paid/ provided for managerial remuneration in accordance with the requisite approvals mandated by the provisions of Section 197 read with Schedule V to the Act.

For Price Waterhouse & Co Chartered Accountants LLP  
Firm Registration Number: 304026E/ E-300009

**Sarah George**

Partner

Membership Number: 045255

UDIN: 22045255AJPZYN4652

Mumbai

May 26, 2022

## Annexure A to Independent Auditor’s Report

Referred to in paragraph 18 of the Independent Auditors’ Report of even date to the members of Hindalco Industries Limited on the Consolidated Financial Statements as of and for the year ended March 31, 2022

As required by paragraph 3(xxi) of the CARO 2020, we report that the auditors of the following companies have given qualification or adverse remarks in their CARO report on the standalone financial statements of the respective companies included in the Consolidated Financial Statements of the Holding Company:

S. No.	Name of the Company	CIN	Relationship with the Holding Company	Date of the respective auditors’ report	Paragraph number and comment in the respective CARO report reproduced below
1	Mahan Coal Limited	U01010MP2006PLC018586	Joint Operation	May 17, 2022	xiv. The Company did not have an internal audit system for the year under Audit. xvii. The Company has incurred cash losses during the current financial year as well as in the immediately preceding financial year. The amount of cash loss during the current year is ₹ 3,361.71 and ₹ 38,615.09 in the immediately preceding financial year.
2	Tubed Coal Mines Limited	U10100MH2007PLC174466	Joint Operation	May 23, 2022	vii. (a). According to the information and explanations given to us and on the basis of our examination of the books of accounts, the Company does not have any undisputed statutory dues related to of Provident Fund, Employees’ State Insurance, Sales Tax, Customs Duty, Excise Duty, VAT and GST as on March 31, 2022. However, the Company is regular in depositing Income tax with the appropriate authorities and there are no undisputed amounts payable for the same were outstanding as at March 31, 2022 for a period exceeding six months from the date they became payable. The Company is yet to pay Professional Tax of ₹ 4,600 for FY 18-19, ₹ 4,600/- for FY 19-20, ₹ 4,600/- for FY 20-21 and ₹ 3,700/- for FY 21-22. xvii. According to the information and explanations given to us and based on our examination of the records of the Company, the Company has incurred cash losses during the financial year covered by our audit and the immediately preceding financial year.

S. No.	Name of the Company	CIN	Relationship with the Holding Company	Date of the respective auditors’ report	Paragraph number and comment in the respective CARO report reproduced below
3.	Renukeshwar Investments & Finance Limited	U65910UP1994PLC017080	Subsidiary	May 11, 2022	xvi. (b) According to the information and explanations given to us, the Company has applied for registration under section 45-IA of the Reserve Bank of India Act, 1934 (2 of 1934) to carry on the business of a NBFC, in the office of RBI, Kanpur, but the registration number is still awaited and has conducted Non-Banking Financial activities as per the Reserve Bank of India Act, 1934.
4.	East Coast Bauxite Mining Company	U13203OR2007PTC009597	Subsidiary	May 23, 2022	xvi. Cash Losses- In our opinion and on the basis of available Financial Statements Subjected to audit, the company has incurred cash losses in the current financial Year and in the immediately preceding Financial Year. The figures of Current Financial Year and the Previous financial Year are ₹ 47,305/- & ₹ 20,862/- respectively.
5.	MNH Shakti Limited	U10100OR2008GOI010171	Joint Venture	May 06, 2022	(xvii) The company has not commenced any business/service during the year. It has incurred cash loss during the financial year covered by our audit and also in the immediately preceding financial year on account of preoperative expenses incurred by the company.
6.	Aditya Birla Renewable Solar Limited	U40106MH2020PLC339323	Associate	April 27, 2022	(xvii) The Company has not incurred the cash losses in the current year however the Company has incurred cash losses of ₹ 33.52 lakhs in the immediately preceding financial year.

For Price Waterhouse & Co Chartered Accountants LLP  
Firm Registration Number: 304026E/ E-300009

**Sarah George**  
Partner  
Membership Number: 045255  
UDIN: 22045255AJPZYN4652

Mumbai  
May 26, 2022



# Annexure B to Independent Auditor's Report

Referred to in paragraph 19(f) of the Independent Auditor's Report of even date to the members of Hindalco Industries Limited on the consolidated financial statements for the year ended March 31, 2022

## Report on the Internal Financial Controls with reference to consolidated financial statements under clause (i) of sub-section 3 of Section 143 of the Act

1. In conjunction with our audit of the consolidated financial statements of the Holding Company as of and for the year ended March 31, 2022, we have audited the internal financial controls with reference to consolidated financial statements of Hindalco Industries Limited [hereinafter referred to as "the Holding Company (excluding two trusts which are not companies incorporated in India)] and its subsidiaries (excluding two subsidiaries which are not companies incorporated in India), its joint venture and its associate companies, which are companies incorporated in India, as of that date.

## Management's Responsibility for Internal Financial Controls

2. The respective Board of Directors of the Holding Company, its joint operations, its subsidiaries, its joint venture and its associate companies, to whom reporting under clause (i) of sub section 3 of Section 143 of the Act in respect of the adequacy of the internal financial controls with reference to financial statements is applicable, which are companies incorporated in India, are responsible for establishing and maintaining internal financial controls based on, internal control over financial reporting criteria established by the Holding Company considering the essential components of internal control stated in the Guidance Note on Audit of Internal Financial Controls Over Financial Reporting ("the Guidance Note") issued by the Institute of Chartered Accountants of India ("ICAI"). These responsibilities include the design, implementation and maintenance of adequate internal financial controls that were operating effectively for ensuring the orderly and efficient conduct of its business, including adherence to the respective company's policies, the safeguarding of its assets, the prevention and detection of frauds and errors, the accuracy and completeness of the accounting records, and the timely preparation of reliable financial information, as required under the Act.

## Auditor's Responsibility

3. Our responsibility is to express an opinion on the Holding Company's internal financial controls with reference to consolidated financial statements based on our audit. We conducted our audit in accordance with the Guidance Note issued by the ICAI and the Standards on Auditing deemed to be prescribed under Section 143(10) of the Companies Act, 2013, to the extent applicable to an audit

of internal financial controls, both applicable to an audit of internal financial controls and both issued by the ICAI. Those Standards and the Guidance Note require that we comply with ethical requirements and plan and perform the audit to obtain reasonable assurance about whether adequate internal financial controls with reference to consolidated financial statements was established and maintained and if such controls operated effectively in all material respects.

4. Our audit involves performing procedures to obtain audit evidence about the adequacy of the internal financial controls system with reference to consolidated financial statements and their operating effectiveness. Our audit of internal financial controls with reference to consolidated financial statements included obtaining an understanding of internal financial controls with reference to consolidated financial statements, assessing the risk that a material weakness exists, and testing and evaluating the design and operating effectiveness of internal control based on the assessed risk. The procedures selected depend on the auditor's judgement, including the assessment of the risks of material misstatement of the consolidated financial statements, whether due to fraud or error.
5. We believe that the audit evidence we have obtained, and the audit evidence obtained by the other auditors in terms of their reports referred to in the Other Matters paragraph below is sufficient and appropriate to provide a basis for our audit opinion on the Holding Company's internal financial controls system with reference to consolidated financial statements.

## Meaning of Internal Financial Controls with reference to financial statements

6. A company's internal financial control with reference to financial statements is a process designed to provide reasonable assurance regarding the reliability of financial reporting and the preparation of financial statements for external purposes in accordance with generally accepted accounting principles. A company's internal financial control with reference to financial statements includes those policies and procedures that (1) pertain to the maintenance of records that, in reasonable detail, accurately and fairly reflect the transactions and dispositions of the assets of the company; (2) provide reasonable assurance that transactions are recorded as necessary to permit preparation of financial statements in accordance with generally accepted accounting principles, and that receipts and expenditures of the company are

being made only in accordance with authorisations of management and directors of the company; and (3) provide reasonable assurance regarding prevention or timely detection of unauthorised acquisition, use, or disposition of the company's assets that could have a material effect on the financial statements.

## Inherent Limitations of Internal Financial Controls with reference to financial statements

7. Because of the inherent limitations of internal financial controls with reference to financial statements, including the possibility of collusion or improper management override of controls, material misstatements due to error or fraud may occur and not be detected. Also, projections of any evaluation of the internal financial controls with reference to financial statements to future periods are subject to the risk that the internal financial control with reference to financial statements may become inadequate because of changes in conditions, or that the degree of compliance with the policies or procedures may deteriorate.

## Opinion

8. In our opinion, the Holding Company, its joint operations, its subsidiary companies, its joint venture and its associate companies, which are companies incorporated in India, have, in all material respects, an adequate internal financial controls system with reference to financial statements and such internal financial controls

with reference to financial statements were operating effectively as at March 31, 2022, based on the internal control over financial reporting criteria established by the Holding Company considering the essential components of internal control stated in the Guidance Note issued by the ICAI.

## Other Matters

9. Our aforesaid reports under Section 143(3)(i) of the Act on the adequacy and operating effectiveness of the internal financial controls with reference to financial statements insofar as it relates to twelve subsidiary companies, two joint operations, one joint venture and four associate companies, which are companies incorporated in India, is based on the corresponding reports of the auditors of such companies incorporated in India. Our opinion is not modified in respect of this matter.

For Price Waterhouse & Co Chartered Accountants LLP  
Firm Registration Number: 304026E/ E-300009

## Sarah George

Partner  
Membership Number: 045255  
UDIN: 22045255AJPZYN4652

Mumbai  
May 26, 2022

# Consolidated Balance Sheet

as at March 31, 2022

(₹ in Crore)

	Note No.	As at	
		31/03/2022	31/03/2021
<b>ASSETS</b>			
<b>Non-Current Assets</b>			
Property, Plant and Equipment (including Right of Use Assets)	2	76,470	70,849
Capital Work-in-Progress	2	4,727	10,013
Investment Property	3	21	21
Goodwill	4	23,965	23,317
Other Intangible Assets	5	6,418	6,082
Intangible Assets under Development	5	218	189
Equity Accounted Investments	48D, E	51	46
Financial Assets			
Investments	6A	8,616	7,670
Trade Receivables	12	-	53
Loans	7	50	12
Derivatives	46B	305	256
Other Financial Assets	8A	786	1,147
Non-Current Tax Assets (Net)	9C	8	4
Deferred Tax Assets (Net)	9B	1,207	924
Other Non-Current Assets	10	1,677	1,525
		<b>124,519</b>	<b>122,108</b>
<b>Current Assets</b>			
Inventories	11	44,483	30,668
Financial Assets			
Investments	6B	5,452	9,417
Trade Receivables	12	21,076	12,959
Cash and Cash Equivalents	13	11,639	8,339
Bank Balances other than Cash and Cash Equivalents	14	5,753	470
Loans	7	7	47
Derivatives	46B	3,366	1,495
Other Financial Assets	8B	2,131	1,211
Current Tax Assets (Net)	9C	186	207
Other Current Assets	10	4,362	2,673
		<b>98,455</b>	<b>67,486</b>
Non-Current Assets or Disposal Group Classified as Held For Sale	15A	88	152
		<b>98,543</b>	<b>67,638</b>
		<b>223,062</b>	<b>189,746</b>
<b>EQUITY AND LIABILITIES</b>			
<b>Equity</b>			
Equity Share Capital	16	222	222
Other Equity	17	77,969	66,311
		<b>78,191</b>	<b>66,533</b>
<b>Non-Controlling Interest</b>			
		11	10
		<b>78,202</b>	<b>66,543</b>

(₹ in Crore)

	Note No.	As at	
		31/03/2022	31/03/2021
<b>Liabilities</b>			
<b>Non-Current Liabilities</b>			
Financial Liabilities			
Borrowings	18A	51,635	58,985
Lease Liabilities	2	972	928
Trade Payables	20		
(I) Outstanding Dues of Micro Enterprises and Small Enterprises		-	-
(II) Outstanding Dues other than Micro Enterprises and Small Enterprises		-	-
Derivatives	46B	464	427
Other Financial Liabilities	21A	139	133
Provisions	22	6,848	8,146
Contract Liabilities	24	10	12
Deferred Tax Liabilities (Net)	9B	5,631	4,530
Other Non-Current Liabilities	23	1,888	1,539
		<b>67,587</b>	<b>74,700</b>
<b>Current Liabilities</b>			
Financial Liabilities			
Borrowings	18B	11,600	6,993
Lease Liabilities	2	279	300
Supplier's Credit	19	2,456	255
Trade Payables	20		
(I) Outstanding Dues of Micro Enterprises and Small Enterprises		105	58
(II) Outstanding Dues other than Micro Enterprises and Small Enterprises		41,277	28,177
Derivatives	46B	10,657	3,601
Other Financial Liabilities	21B	3,607	2,531
Provisions	22	2,841	2,610
Current Tax Liabilities (Net)	9C	2,120	2,126
Contract Liabilities	24	365	347
Other Current Liabilities	23	1,873	1,386
		<b>77,180</b>	<b>48,384</b>
Liability Associated with Disposal Group Classified as Held For Sale	15B	93	119
		<b>77,273</b>	<b>48,503</b>
		<b>144,860</b>	<b>123,203</b>
		<b>223,062</b>	<b>189,746</b>
<b>Basis of Preparation and Significant Accounting Policies</b>	1		

The accompanying Notes are an integral part of the Consolidated Financial Statements

This is the Consolidated Balance Sheet referred in our report of even date

For and on behalf of the Board of Hindalco Industries Limited

**For Price Waterhouse & Co Chartered Accountants LLP**  
Firm Registration No. 304026E/E-300009

**Praveen Kumar Maheshwari**  
Whole-time Director and  
Chief Financial Officer  
DIN-00174361

**Satish Pai**  
Managing Director  
DIN-06646758

**Sarah George**  
Partner  
Membership No. 045255

**Anil Malik**  
Company Secretary

**K N Bhandari**  
Director  
DIN-00026078

Place: Mumbai  
Date: May 26, 2022



# Consolidated Statement of Profit and Loss

for the year ended March 31, 2022

	Note No.	Year ended	
		31/03/2022	31/03/2021
(₹ in Crore)			
<b>CONTINUING OPERATIONS:</b>			
<b>INCOME</b>			
Revenue from Operations	25	195,059	132,008
Other Income	26	1,136	1,199
<b>Total Income</b>		<b>196,195</b>	<b>133,207</b>
<b>EXPENSES</b>			
Cost of Materials Consumed	27	125,335	77,484
Trade Purchases	28	1,958	1,098
Changes in Inventories of Finished Goods, Work-in-Progress and Stock-in-Trade	29	(9,753)	(2,146)
Employee Benefits Expense	30	11,936	10,782
Power and Fuel	31	11,146	8,667
Finance Cost	32	3,768	3,738
Depreciation and Amortization Expense	33	6,729	6,628
Impairment Loss/ (Reversal) on Non-Current Assets (Net)	34	155	138
Impairment Loss/ (Reversal) on Financial Assets (Net)	35	155	(26)
Other Expenses	36	25,780	18,452
<b>Total Expenses</b>		<b>177,209</b>	<b>124,815</b>
Profit/ (Loss) before Share in Profit/ (Loss) in Equity Accounted Investments, Exceptional Items and Tax		18,986	8,392
Share in Profit/ (Loss) in Equity Accounted Investments (Net of Tax)	48D,E	6	5
Profit/ (Loss) before Exceptional Items and Tax		18,992	8,397
Exceptional Income/ (Expenses) (Net)	37	582	(492)
<b>Profit/ (Loss) before Tax</b>		<b>19,574</b>	<b>7,905</b>
<b>Tax Expense</b>			
Current Tax Expense	9A	3,801	1,881
Deferred Tax Expense		1,572	842
<b>Profit/ (Loss) for the year from Continuing Operations</b>		<b>14,201</b>	<b>5,182</b>
<b>DISCONTINUED OPERATIONS:</b>			
Profit/ (Loss) for the Year from Discontinued Operations	50	(464)	(2,066)
Tax Expense/ (Benefit) of Discontinued Operations		7	(367)
<b>Profit/ (Loss) for the year from Discontinued Operations</b>		<b>(471)</b>	<b>(1,699)</b>
<b>Profit/ (Loss) for the year</b>		<b>13,730</b>	<b>3,483</b>
<b>Other Comprehensive Income/ (Loss)</b>			
<b>Items that will not be reclassified to Statement of Profit and Loss</b>			
Remeasurement of Defined Benefit Obligation		1,172	1,117
Remeasurement of Defined Benefit Obligation of Discontinued Operations		-	60
Change in Fair Value of Equity Instruments Designated as FVTOCI		1,211	4,358
Share in Equity Accounted Investments		-	-
Income Tax effect		(537)	(327)

	Note No.	Year ended	
		31/03/2022	31/03/2021
(₹ in Crore)			
<b>Items that will be reclassified to Statement of Profit and Loss</b>			
Change in Fair Value of Debt Instruments Designated as FVTOCI		(9)	(9)
Effective Portion of Cash Flow Hedges		(4,867)	(1,769)
Cost of Hedging Reserve		(75)	(168)
Foreign Currency Translation Reserve		525	959
Income Tax effect		1,432	563
<b>Other Comprehensive Income/ (Loss) for the year</b>		<b>(1,148)</b>	<b>4,784</b>
<b>Total Comprehensive Income/ (Loss) for the year</b>		<b>12,582</b>	<b>8,267</b>
<b>Profit/ (Loss) attributable to:</b>			
Owners of the Company		13,730	3,483
Non-Controlling Interests		-	-
<b>Other Comprehensive Income/ (Loss) attributable to:</b>			
Owners of the Company		(1,148)	4,784
Non-Controlling Interests		-	-
<b>Total Comprehensive Income/ (Loss) attributable to:</b>		<b>12,582</b>	<b>8,267</b>
Owners of the Company		12,582	8,267
Non-Controlling Interests		-	-
<b>Total Comprehensive Income/ (Loss) attributable to Owners of the Company from:</b>			
Continuing Operations		13,053	9,915
Discontinued Operations		(471)	(1,648)
<b>Earnings Per Share:</b>	39		
Basic - Continuing Operations (₹)		63.85	23.30
Diluted - Continuing Operations (₹)		63.77	23.29
Basic - Discontinued Operations (₹)		(2.12)	(7.64)
Diluted - Discontinued Operations (₹)		(2.12)	(7.64)
Basic - Continuing and Discontinued Operations (₹)		61.73	15.66
Diluted - Continuing and Discontinued Operations (₹)		61.65	15.65
<b>Basis of Preparation and Significant Accounting Policies</b>	1		

The accompanying Notes are an integral part of the Consolidated Financial Statements

This is the Consolidated Statement of Profit and Loss referred in our report of even date

For and on behalf of the Board of **Hindalco Industries Limited**

**For Price Waterhouse & Co Chartered Accountants LLP**  
Firm Registration No. 304026E/E-300009

**Praveen Kumar Maheshwari**  
Whole-time Director and  
Chief Financial Officer  
DIN-00174361

**Satish Pai**  
Managing Director  
DIN-06646758

**Sarah George**  
Partner  
Membership No. 045255

**Anil Malik**  
Company Secretary

**K N Bhandari**  
Director  
DIN-00026078

Place: Mumbai  
Date: May 26, 2022

# Consolidated Statement of Changes in Equity

for the year ended March 31, 2022

## A. Equity Share Capital

Particulars	Amount	
	Note	Amount
Balance as at April 01, 2020	16	222
Balance as at March 31, 2021	16	222
Balance as at March 31, 2022	16	222

## B. Other Equity

Particulars	Note	Equity Component of Other Financial Instruments	Reserve and Surplus						Other Reserves				Attributable to Owners of the Company	Attributable to Non Controlling Interests	Total Other Equity					
			Capital Reserve	Capital Redemption Reserve	Business Reconstruction Reserve	Securities Premium	Debt Redemption Reserve	Employees Stock Options	Treasury Shares held by ESOP Trust	Special Reserve	General Reserve	Retained Earnings				Gain/(Loss) on Equity Instruments FVTOCI	Gain/(Loss) on Debt Instruments FVTOCI	Effective portion of Cash Flow Hedge	Cost of Hedging Reserve	Foreign Currency Translation Reserve
Balance as at April 01, 2020		4	147	104	5,799	8,228	1,200	44	(130)	19	21,370	18,806	325	7	(130)	119	2,193	58,095	10	58,105
Profit/ (Loss) for the year		-	-	-	-	-	-	-	-	-	-	3,483	-	-	-	-	-	3,483	-	3,483
Other Comprehensive Income/(Loss) for the year		-	-	-	-	-	-	-	-	-	-	860	4,348	(6)	(1,268)	(109)	959	4,784	-	4,784
Total Comprehensive Income/(Loss) for the year		-	-	-	-	-	-	-	-	-	-	4,343	4,348	(6)	(1,268)	(109)	959	8,267	-	8,267
Hedging (gain)/ loss and cost of hedging transferred to non-financial assets		-	-	-	-	-	150	-	-	-	-	(150)	-	-	142	-	-	142	-	142
Transfer to Debenture Redemption Reserve		-	-	-	-	-	-	-	-	-	-	-	-	-	-	-	-	-	-	-
Transfer to Special Reserve		-	-	-	-	-	-	-	-	1	-	(1)	-	-	-	-	-	-	-	-
Other Changes		-	-	-	-	-	-	-	-	-	-	-	-	10	-	-	-	10	-	10
Transactions with owners in their capacity as owners		-	-	-	-	-	-	-	-	-	-	-	-	-	-	-	-	-	-	-
Shares Issued by the Trust		-	-	-	-	-	-	-	1	-	-	-	-	-	-	-	-	-	1	1
Employee Share Based Transactions		-	-	-	-	-	-	-	(4)	-	-	-	-	-	-	-	-	-	3	3
Employee Share Options Expenses		-	-	-	-	-	-	-	15	-	-	-	-	-	-	-	-	-	15	15
Employee Share Options Lapsed/Forfeited		-	-	-	-	-	-	-	(1)	-	-	-	-	-	-	-	-	-	-	-
Dividend Paid		-	-	-	-	-	-	-	-	-	-	(222)	-	-	-	-	-	(222)	-	(222)

Particulars	Note	Equity Component of Other Financial Instruments	Reserve and Surplus						Other Reserves				Attributable to Owners of the Company	Attributable to Non Controlling Interests	Total Other Equity						
			Capital Reserve	Capital Redemption Reserve	Business Reconstruction Reserve	Securities Premium	Debt Redemption Reserve	Employees Stock Options	Treasury Shares held by ESOP Trust	Special Reserve	General Reserve	Retained Earnings				Gain/(Loss) on Equity Instruments FVTOCI	Gain/(Loss) on Debt Instruments FVTOCI	Effective portion of Cash Flow Hedge	Cost of Hedging Reserve	Foreign Currency Translation Reserve	
Balance as at March 31, 2021	17	4	147	104	5,799	8,225	1,350	54	(129)	20	21,370	22,777	4,673	1	(1,246)	10	3,152	66,311	10	66,321	
Profit/ (Loss) for the year		-	-	-	-	-	-	-	-	-	-	13,730	-	-	-	-	-	-	13,730	-	13,730
Other Comprehensive Income/(Loss) for the year		-	-	-	-	-	-	-	-	-	-	883	963	(6)	(3,464)	(49)	525	(148)	-	(148)	
Total Comprehensive Income/(Loss) for the year		-	-	-	-	-	-	-	-	-	-	14,663	963	(6)	(3,464)	(49)	525	12,582	-	12,582	
Hedging (gain)/ loss and cost of hedging transferred to non-financial assets		-	-	-	-	-	-	-	-	-	-	-	-	-	(15)	-	-	(15)	-	(15)	
Realised Gain/(Loss) on Equity FVTOCI transferred to Retained Earnings		-	-	-	-	-	-	-	-	-	-	302	(302)	-	-	-	-	-	-	-	
Transfer to Debenture Redemption Reserve		-	-	-	-	-	150	-	-	-	-	(150)	-	-	-	-	-	-	-	-	
Transfer to Special Reserve		-	-	-	-	-	-	-	-	-	-	(67)	-	-	(33)	-	32	(68)	1	(67)	
Other Changes		-	-	-	-	-	-	-	-	-	-	-	-	-	-	-	-	-	-	-	
Transactions with owners in their capacity as owners		-	-	-	-	-	-	-	-	-	-	-	-	-	-	-	-	-	-	-	
Share in Equity Accounted Investments		-	-	-	-	-	-	-	-	-	-	-	-	-	-	-	-	-	-	-	
Shares Acquired by the Trust		-	-	-	-	-	-	-	(94)	-	-	-	-	-	-	-	-	(94)	-	(94)	
Shares Issued by the Trust		-	-	-	-	-	-	-	24	-	-	2	-	-	-	-	-	15	-	15	
Employee Share Based Transactions		-	-	-	-	-	-	-	(3)	-	-	-	-	-	-	-	-	6	-	6	
Employee Share Options Expenses		-	-	-	-	-	-	-	35	-	-	-	-	-	-	-	-	35	-	35	
Dividend Paid		-	-	-	-	-	-	-	-	-	-	(667)	-	-	-	-	-	(667)	-	(667)	
Balance as at March 31, 2022	17	4	147	104	5,799	8,234	1,500	75	(199)	20	21,370	36,810	5,334	(5)	(4,894)	(59)	3,709	77,969	11	77,980	
Basis of Preparation and Significant Accounting Policies	1																				

The accompanying Notes are an integral part of the Consolidated Financial Statements

This is the Consolidated Statement of Changes in Equity referred in our report of even date

For and on behalf of the Board of Hindalco Industries Limited

**For Price Waterhouse & Co Chartered Accountants LLP**  
Firm Registration No. 304026E/E-300009

**Praveen Kumar Maheshwari**  
Whole-time Director and  
Chief Financial Officer  
DIN-00174361

**Satish Pai**  
Managing Director  
DIN-06646758

**Sarah George**  
Partner  
Membership No. 045255

**Anil Malik**  
Company Secretary

**K N Bhandari**  
Director  
DIN-00026078

Place: Mumbai  
Date: May 26, 2022



# Consolidated Statement of Cash Flows

for the year ended March 31, 2022

	Note No.	Year ended	
		₹ in Crore)	
		31/03/2022	31/03/2021
<b>A. CASH FLOW FROM OPERATING ACTIVITIES</b>			
Profit/ (Loss) before Tax from Continuing Operations		19,574	7,905
Adjustment for :			
Finance Cost	32	3,768	3,738
Depreciation and Amortization Expense	33	6,729	6,628
Impairment Loss/ (Reversal) of Non-Current Assets (Net)	34	155	138
Impairment Loss/ (Reversal) on Financial Assets (Net)	35	155	(26)
Non-Cash Employee Share-Based payments	30	35	15
Share in (Profit)/ Loss in Equity Accounted Investments (Net of Tax)	48D, E	(6)	(5)
Unrealised Foreign Exchange (Gain)/ Loss (Net)		(113)	(37)
Unrealised (Gain)/ Loss on Derivative Transactions (Net)		353	487
(Gain)/ Loss on Modification of Borrowings (Net)		(183)	(117)
(Gain)/ Loss on Property, Plant and Equipment and Intangible Assets Sold/ Discarded (Net)	26	100	35
Interest Income	26	(225)	(181)
Dividend Income	26	(32)	(25)
(Gains)/ Losses on Investments measured at Fair Value through Profit and Loss (Net)	26	(359)	(543)
Exceptional (Income)/ Expenses (Net)		(5)	(127)
Changes in Cash Flow Hedges net of reclassification from OCI		(34)	(121)
Amortisation of government grants		(255)	(116)
Other Non-operating (Income)/ Expenses (Net)		69	-
<b>Operating Profit before Working Capital Changes</b>		<b>29,726</b>	<b>17,648</b>
Changes in Working Capital:			
(Increase)/ Decrease in Inventories		(13,690)	(4,640)
(Increase)/ Decrease in Trade Receivables		(7,886)	(2,001)
(Increase)/ Decrease in Other Financial Assets		(285)	346
(Increase)/ Decrease in Non-Current Assets		(1,434)	399
Increase/ (Decrease) in Trade Payables		12,683	7,361
Increase/ (Decrease) in Other Financial Liabilities		983	(289)
Increase/ (Decrease) in Non-Current Liabilities (incl. contract liabilities)		497	344
<b>Cash Generated from Operation before Tax</b>		<b>20,594</b>	<b>19,168</b>
Refund/ (Payment) of Income Tax (Net)		(3,773)	(1,256)
<b>Net Cash Generated/ (Used) - Operating Activities - Continuing Operations</b>		<b>16,821</b>	<b>17,912</b>
<b>Net Cash Generated/ (Used) - Operating Activities - Discontinued Operations</b>		<b>17</b>	<b>(680)</b>
<b>Net Cash Generated/ (Used) - Operating Activities</b>		<b>16,838</b>	<b>17,232</b>
<b>B. CASH FLOW FROM INVESTMENT ACTIVITIES</b>			
Payments to acquire Property, Plant and Equipment, Intangible Assets and Investment Property		(5,426)	(5,565)
Proceeds from disposal of Property, Plant and Equipment, Intangible Assets and Investment Property		71	48
Net cash inflow on disposal of Subsidiaries		66	-
Acquisition of business, net of cash acquired		(412)	(19,524)
Investment in equity accounted investees		(1)	-
Investment in Equity Shares at FVTOCI		363	(43)
(Purchase)/ Sale of Other Investments (Net)		4,226	(2,775)
Loans and Deposits given		(6,214)	(266)
Receipt of Loans and Deposits given		5	5
Interest Received		207	203
Dividend Received		32	25
Lease payments received from finance lease		9	10
<b>Net Cash Generated/ (Used) - Investing Activities - Continuing Operations</b>		<b>(7,074)</b>	<b>(27,882)</b>
<b>Net Cash Generated/ (Used) - Investing Activities - Discontinued Operations</b>		<b>-</b>	<b>2,245</b>
<b>Net Cash Generated/ (Used) - Investing Activities</b>		<b>(7,074)</b>	<b>(25,637)</b>

	Note No.	Year ended	
		₹ in Crore)	
		31/03/2022	31/03/2021
<b>C. CASH FLOW FROM FINANCING ACTIVITIES</b>			
Proceeds from issue of Equity Shares (Including Share Application Money)		6	3
Treasury Shares acquired by ESOP Trust		(94)	-
Proceeds from shares issued by ESOP Trust		15	2
Redemption of Debentures		(3)	(3)
Proceeds from Borrowings		14,197	14,105
Pre-payment of Non-current Borrowings		(17,321)	(12,472)
Repayment of Borrowings		(623)	(4,053)
Increase/ (Decrease) in Supplier's Credit (Net)		2,161	255
Principal Payments of Lease Liabilities		(337)	(331)
Proceeds from/ (Repayment) of Current Borrowings (Net)		(849)	1,528
Finance Cost Paid		(3,250)	(3,678)
Dividend Paid (including Dividend Distribution Tax)		(667)	(222)
<b>Net Cash Generated/ (Used) - Financing Activities - Continuing Operations</b>		<b>(6,765)</b>	<b>(4,866)</b>
<b>Net Cash Generated/ (Used) - Financing Activities - Discontinued Operations</b>		<b>-</b>	<b>(16)</b>
<b>Net Cash Generated/ (Used) - Financing Activities</b>		<b>(6,765)</b>	<b>(4,882)</b>
<b>Net Increase/ (Decrease) in Cash and Cash Equivalents</b>		<b>2,999</b>	<b>(13,287)</b>
Add : Opening Cash and Cash Equivalents		8,339	21,269
Add : Effect of exchange variation on Cash and Cash Equivalents		301	357
Closing Cash and Cash Equivalents		11,639	8,339
<b>Reconciliation of Closing Cash and Cash Equivalents with Balance Sheet:</b>			
Cash and Cash Equivalents as per Balance Sheet	13	11,639	8,339
Less: Temporary Overdraft Balance in Current Accounts		-	-
<b>Cash and Cash Equivalents as per Cash Flow Statement</b>		<b>11,639</b>	<b>8,339</b>
<b>Supplemental Information</b>			
(i) Non Cash Transactions from Investing and Financing Activities:			
Acquisition of Right of Use Assets		412	451
(ii) Capitalised interest paid included in Investing activities		118	151
<b>Basis of Preparation and Significant Accounting Policies</b>	1		

The accompanying Notes are an integral part of the Consolidated Financial Statements

This is the Consolidated Statement of Cash Flows referred in our report of even date

For and on behalf of the Board of **Hindalco Industries Limited**

**For Price Waterhouse & Co Chartered Accountants LLP**  
Firm Registration No. 304026E/E-300009

**Praveen Kumar Maheshwari**  
Whole-time Director and  
Chief Financial Officer  
DIN-00174361

**Satish Pai**  
Managing Director  
DIN-06646758

**Sarah George**  
Partner  
Membership No. 045255

**Anil Malik**  
Company Secretary

**K N Bhandari**  
Director  
DIN-00026078

Place: Mumbai  
Date: May 26, 2022

# Notes

## forming part of the Consolidated Financial Statements

### Company Overview

Hindalco Industries Limited ("the Company/ Parent") was incorporated in India in the year 1958 having its registered office at Ahura Centre, 1st Floor, B Wing, Mahakali Caves Road, Andheri (East), Mumbai - 400093.

The Company has two main stream of business Aluminium and Copper.

In Aluminium, the Company caters to the entire value chain starting from mining of bauxite and coal through production of value added products for various application.

The Company along with its subsidiaries has manufacturing operations in ten countries including India spread over four continents North America, South America, Asia and Europe. Apart from primary aluminium, the Company produces aluminium sheet, extrusion and light gauge products for use in packaging market which includes beverage and food, can and foil products as well as for use in automotive, electronic, architecture, transportation and industrial product markets.

The Company also has one of the largest single location Copper smelting facility in India.

The equity shares of the Company are listed on National Stock Exchange of India Limited (NSE) and BSE Limited (BSE) and GDRs are listed on the Luxembourg Stock Exchange.

### 1. Basis of Preparation and Significant Accounting Policies

#### 1A. Basis of Preparation

The Consolidated Financial Statements ("the financial statements") relate to the Company and its subsidiaries (collectively "the Group") and certain unstructured entities consolidated by the Group and its interest in associates and joint ventures. The consolidated financial statements comply in all material aspects with Indian Accounting Standards ("Ind-AS") as prescribed under section 133 of the Companies Act 2013 ("the Act"), as notified under the Companies (Indian Accounting Standards) Rules, 2015, (including subsequent amendments) and other accounting principles generally accepted in India.

The Group's consolidated financial statements for the year ended March 31, 2022 have been approved for issue by the Board of Directors of the Company in their meeting held on May 26, 2022.

The financial statements have been prepared under the historical cost convention on accrual basis except for following assets and liabilities which have been measured at fair value:

- Certain financial instruments - measured at fair value;
- Assets held for sale - measured at fair value less cost to sell;
- Plan assets under defined benefit plans - measured at fair value;
- Liabilities for Cash settled share-based payments; and

- Inventories those are designated in a Fair value hedge relationship where both the derivative and inventory are fair valued.

In addition, the carrying values of recognised assets and liabilities designated as hedged items in fair value hedges that would otherwise be carried at cost are adjusted to record changes in the fair values attributable to the risks that are being hedged in effective hedge relationship.

Historical cost is generally based on the fair value of the consideration given in exchange for goods and services.

Fair value is the price that would be received to sell an asset or paid to transfer a liability in an orderly transaction between market participants at the measurement date, regardless of whether that price is directly observable or estimated using another valuation technique. In estimating the fair value of an asset or a liability, the Group take into account the characteristics of the asset or liability if market participants would take those characteristics into account when pricing the asset or liability at the measurement date. Fair value for measurement and/or disclosure purposes in the financial statements is determined on such a basis, except for employee share-based payment, leasing transactions and measurements that have some similarities to fair value but are not fair value, such as net realisable value in Inventories or value in use in Impairment of Assets. The basis of fair valuation of these items are given as part of their respective accounting policies.

The Group has determined current and non-current classification of its assets and liabilities in the financial statements as per the requirement of Ind AS1- 'Presentation of Financial Statements'. Based on its assessment, the Group has ascertained its normal operating cycle as 12 months for the purpose of current and non-current classification of its assets and liabilities.

In addition, for financial reporting purposes, fair value measurements are categorised into Level 1, 2 or 3 based on the degree to which the inputs to the fair value measurements are observable and the significance of the inputs to the fair value measurement in its entirety, which are described as follows:

- Level 1 inputs are quoted prices (unadjusted) in active markets for identical assets or liabilities that the Group can access at the measurement date;
- Level 2 inputs are inputs, other than quoted prices included within Level 1, that are observable for the asset or liability, either directly or indirectly; and
- Level 3 inputs are unobservable inputs for the asset or liability.

The Consolidated Financial Statements are presented in Indian Rupees (INR/₹) which is also the Parent's Functional Currency. All financial information presented in INR has been rounded off to nearest crore Rupees (INR 1 crore = INR 10,000,000) without any decimal, unless otherwise stated.

### 1B. Significant Accounting Policies:

#### A. Principles of Consolidation

##### Subsidiaries

Subsidiaries are the entities (including structured and unstructured entities) over which the Group has control. The Group controls an entity when the group is exposed to or has rights to, variable returns from its involvement with the entity and has the ability to affect those returns through its power to direct the relevant activities of the entity. Consolidation of subsidiary begins when the Group obtains control over the subsidiary and ceases when the Group loses control of the subsidiary. Assets, liabilities, income and expenses of a subsidiary acquired or disposed of during the year are included in the consolidated financial statements from the date the Group gains the control until the date the Group ceases to control the subsidiary.

The Group combines the financial statements of the parent and its subsidiaries line by line adding together like items of assets, liabilities, equity, income and expenses. Intra-group transactions, balances and unrealised profits on transactions between group companies are eliminated in full. Unrealised losses are also eliminated unless the transaction provides evidence of an impairment of the transferred assets. Appropriate adjustments for deferred taxes are made for temporary differences that arise from the elimination of unrealised profits and losses from intra-group transactions or undistributed earnings of Group's entity included in consolidated profit and loss, if any.

The consolidated financial statements are prepared using uniform accounting policies for like transactions and other events in similar circumstances. If any entity within the Group uses accounting policies other than those adopted in the consolidated financial statements for like transactions and events in similar circumstances, appropriate adjustments are made to that group entity's financial statements to ensure conformity with the Group's accounting policies. The financial statements of all entities used for the purpose of consolidation are drawn up to the same reporting date as that of the parent company. When the end of the reporting period of the parent is different from that of a subsidiary, the subsidiary prepares additional financial information as of the same date as the financial statements of the parent to enable the parent to consolidate the financial information of the subsidiary, unless it is impractical to do so.

Non-controlling interest in the profit / loss and equity of the subsidiaries are shown separately in the consolidated statement of profit and loss and the consolidated balance sheet, respectively.

A change in the ownership interest of a subsidiary, without a loss of control, is accounted for as an equity transaction. This results in an adjustment between the carrying amounts of the controlling and non-controlling interests to reflect their relative interests in the subsidiary. Any difference between the amount of the adjustment to non-controlling interests and any consideration paid or received is recognised within equity attributable to owners of the parent.

In case the Group ceases to consolidate a subsidiary because of a loss of control, any retained interest in the entity is re-measured to its fair value. This fair value becomes the initial carrying amount for the purpose of subsequently accounting for the retained interest as an associate, joint venture or financial assets. When the Group loses control over a subsidiary, it derecognises the assets, including goodwill, and liabilities of the subsidiary, carrying amount of any non-controlling interests, cumulative translation differences recorded in equity and recognise resulting difference between the fair value of the investment retained and the consideration received and total of amount derecognised as gain or loss attributable to the Parent. In addition, amounts, if any, previously recognised in other comprehensive income in relation to that entity are reclassified to profit or loss as would be required if the parent had directly disposed of the related assets or liabilities.

#### Interest in Associates and Joint Ventures

An associate is an entity over which the Group has significant influence. Significant influence is the power to participate in the financial and operating policy decisions of the investee but is not control or joint control over those policies, generally accompanying a shareholding between 20% and 50% of the voting rights.

A joint venture is a joint arrangement whereby the parties that have joint control of the arrangement have rights to the net assets of the joint arrangement. Joint control is the contractually agreed sharing of control of an arrangement, which exists only when decisions about the relevant activities require unanimous consent of the parties sharing control.

The Group's interest in its associates or joint ventures are accounted for using the equity method from the date on which the investee becomes an associate or a joint venture. Under equity method, the investment in an associate or a joint venture is initially recognised at cost and adjusted thereafter to recognise the changes in the Group's share of net assets of the associate or joint venture since the acquisition date. Dividends received



# Notes

forming part of the Consolidated Financial Statements

or receivable from associates and joint ventures are recognised as a reduction in the carrying amount of the investment. On acquisition of the investment in an associate or a joint venture, any excess of the cost of the investment over the Group's share of the net fair value of the identifiable assets and liabilities of the investee is recognised as Goodwill, which is included within the carrying amount of the investment. Any excess of the Group's share of the net fair value of the identifiable assets and liabilities over the cost of the investment is recognised in equity as Capital Reserve in the period in which the investment is acquired.

The consolidated statement of profit and loss reflects the Group's share of the results of operations of the associate or joint venture. Any change in other comprehensive income (OCI) is presented as part of the Group's OCI. In addition, when there has been a change recognised directly in the equity of the associate or joint venture, the Group recognises its share of that change, when applicable, in the consolidated statement of changes in equity. Unrealised gains or losses resulting from transactions between the Group and the associate or joint venture are eliminated to the extent of the interest in the associate or joint venture.

When the Group's share of losses of an associate or a joint venture equals or exceeds its interest in that associate or joint venture (which includes any long-term interests that, in substance, form part of the Group's net investment in the associate or joint venture), the Group discontinues recognising its share of further losses. Additional losses are recognised only to the extent that the Group has incurred legal or constructive obligations or made payments on behalf of the associate or joint venture. If the associate or joint venture subsequently reports profits, the group resumes recognising its share of those profits only after its share of the profit equals the share of losses not recognised.

At each reporting date, the Group determines whether there is objective evidence that the investment in the associate or joint venture is impaired. If there is such evidence, the Group calculates the amount of impairment as the difference between the recoverable amount of the associate or joint venture and its carrying value, and then recognises the impairment loss in the consolidated statement of profit and loss. Any reversal of that impairment loss is recognised to the extent that the recoverable amount of the investment subsequently increases. Goodwill relating to associate or joint venture is included in the carrying amount of the investment and is not separately tested for impairment.

The Group continues to use the equity method when an investment in an associate becomes an investment in a joint venture or an investment in a joint venture becomes an investment in an associate.

If ownership interest in an associate or a joint venture is reduced but significant influence or joint control is retained, the Group continues to use the equity method, and only proportionate share of the amount previously recognised in other comprehensive income are reclassified to consolidated statement of profit and loss where appropriate.

When the Group classified its investments, or a portion thereof, in associate or joint venture as held for sale, it discontinues the use of the equity method in relation to the portion that is classified as held for sale. Any retained portion of an investment in an associate or a joint venture that has not been classified as held for sale continues to be accounted for using the equity method. The Group discontinues the use of the equity method at the time of disposal when the disposal results in the Group losing significant influence over the associate or joint venture.

Upon loss of significant influence over the associate or joint venture, the group measures and recognises any retained investment at its fair value. Any difference between the carrying amount of the associate or joint venture and the fair value of retained investment and proceeds from disposal is recognised in the consolidated statement of profit and loss.

See Note 48 - Interest in Other Entities for further details.

## B. Business Combination

Business combinations are accounted for using the acquisition method. The consideration transferred in a business combination comprises the fair values of the assets transferred, liabilities incurred to the former owners of the acquired business, equity interests issued by the Group and fair value of any assets or liability resulting from a contingent consideration arrangement. Acquisition-related costs are expensed as incurred.

At the acquisition date, the identifiable assets acquired and liabilities and contingent liabilities assumed in a business combination are measured at their acquisition date fair values. However, certain assets and liabilities i.e. deferred tax assets or liabilities, assets or liabilities related to employee benefit arrangements, liabilities or equity instruments related to share-based payment arrangements, lease liabilities under Ind AS 116 and assets or disposal groups that are classified as held for sale, acquired or assumed in a business combination are measured as per the applicable Ind-AS.

The Group recognises any non-controlling interest in the acquired entity on an acquisition-by-acquisition basis either at fair value or at the non-controlling interest's proportionate share of the acquired entity's net identifiable assets.

The excess of the sum of the consideration transferred the amount of any non-controlling interests in the acquired entity and the acquisition-date fair value of any previous equity interest in the acquired entity over the acquisition-date fair value of the net identifiable assets acquired is recognised as goodwill. Any gain on a bargain purchase is recognised in other comprehensive income and accumulated in equity as Capital Reserve if there exists clear evidence of the underlying reasons for classifying the business combination as resulting in a bargain purchase, otherwise the gain is recognised directly in equity as Capital Reserve.

Where settlement of any part of cash consideration is deferred, the amounts payable in future are discounted to their present value as at the date of exchange. The discount rate used is entity's incremental borrowing rate, being the rate at which similar borrowing could be obtained from an independent financier under comparable terms and conditions.

Any contingent consideration is measured at fair value at the date of acquisition. If an obligation to pay contingent consideration that meets the definition of a financial instrument is classified as equity, then it is not re-measured subsequently and settlement is accounted for within equity. Other contingent consideration is re-measured at fair value at each reporting date and changes in the fair value of contingent consideration are recognised in profit or loss.

When a business combination is achieved in stages, any previously held equity interest in the acquiree is re-measured at its acquisition-date fair value and the resulting gain or loss, if any, is recognised in the consolidated statement of profit and loss or other comprehensive income, as appropriate.

Where it is not possible to complete the determination of fair values by the end of the reporting period in which the combination occurs, a provisional assessment of fair values is made and any adjustments required to those provisional values, and the corresponding adjustments to goodwill, are finalised within 12 months of the acquisition date.

See Note 49 - Business Combination for further details.

## C. Interest in Joint Operations

A joint operation is a joint arrangement whereby the parties that have joint control of the arrangement have rights to the assets, and obligations for the liabilities, relating to the arrangement. Joint control is the contractually agreed sharing of control of an arrangement, which exists only when decisions about the relevant activities require unanimous consent of the parties sharing control.

When a Group entity undertakes its activities under joint operations, the Group as a joint operator recognises in relation to its interest in a joint operation:

- its assets, including its share of any assets held jointly;
- its liabilities, including its share of any liabilities incurred jointly;
- its revenue from the sale of its share of the output arising from the joint operation;
- its share of the revenue from the sale of the output by the joint operation; and
- its expenses, including its share of any expenses incurred jointly.

The Group accounts for the assets, liabilities, revenues and expenses relating to its interest in a joint operation in accordance with the standard applicable to the particular assets, liabilities, revenues and expenses.

When a Group entity transacts with a joint operation in which a group entity is a joint operator (such as a sale or contribution of assets), the Group is considered to be conducting the transaction with the other parties to the joint operation, and gains and losses resulting from the transactions are recognised in the financial statements only to the extent of other parties' interests in the joint operation.

When a group entity transacts with a joint operation in which a group entity is a joint operator (such as a purchase of assets), the Group does not recognise its share of the gains and losses until it resells those assets to a third party.

See Note 48 - Interest in Other Entities for further details.

## D. Property, Plant and Equipment

Property, plant and equipment held for use in the production or/and supply of goods or services, or for administrative purposes, are stated in the consolidated balance sheet at cost, less any subsequent accumulated depreciation and subsequent accumulated impairment losses.

The initial cost at cash price equivalent of property, plant and equipment acquired comprises its purchase price, including import duties and non-refundable purchase taxes, any directly attributable costs of bringing the assets to its working condition and location and present value of any obligatory decommissioning costs for its intended use. Cost may also include effective portion on qualifying cash flow hedges of foreign currency purchases of property, plant and equipment recycled from hedge reserve as basis adjustment.

# Notes

forming part of the Consolidated Financial Statements

In case of self-constructed assets, cost includes the costs of all materials used in construction, direct labour, allocation of overheads, directly attributable borrowing costs and effective portion of cash flow hedges of foreign currency transferred from the hedge reserve as basis adjustment.

Subsequent expenditure on major maintenance or repairs includes the cost of the replacement of parts of assets and overhaul costs. Where an asset or part of an asset is replaced and it is probable that future economic benefits associated with the item will be available to the Group, the expenditure is capitalised and the carrying amount of the item replaced is derecognised. Similarly, overhaul costs associated with major maintenance which can be measured reliably are capitalised and depreciated over their useful lives where it is probable that future economic benefits will be available and any remaining carrying amounts of the cost of previous overhauls are derecognised. All other costs are charged to profit and loss during the reporting period in which they are incurred.

## Capital work-in-progress

Capital work-in-progress comprise of tangible items in the course of construction for production or/and supply of goods or services or administrative purposes are carried at cost, less any accumulated impairment loss. At the point when an asset is capable of operating at management's intended use, the cost of construction is transferred to the appropriate category of property, plant and equipment. Costs associated with the commissioning of an asset are capitalised.

## Depreciation

Depreciation is charged so as to write off the cost or value of assets, over their estimated useful lives. Depreciation is recorded using the straight line basis. The estimated useful lives and residual values are reviewed at each year end, with the effect of any changes in estimate accounted for on a prospective basis. Each component of an item of property, plant and equipment with a cost that is significant in relation to the total cost of that item is depreciated separately if its useful life differs from the others components of the asset.

Depreciation commences when the assets are ready for their intended use. Depreciated assets in property and accumulated depreciation accounts are retained fully until they are removed/retired from active use.

Leasehold improvements are depreciated over the shorter of their useful life or the lease term, unless the entity expects to use the assets beyond the lease term.

The useful life of the items of Property, Plant and Equipment estimated by the management for the current and comparative period are in line with the useful life as per Schedule II of the Companies Act, 2013. (refer Note 2).

## Disposal of assets

An item of property, plant and equipment is derecognised upon disposal or when no future economic benefits are expected to arise from the continued use of the asset. Any gain or loss arising on the disposal or retirement of an item of property, plant and equipment is determined as the difference between net disposal proceeds and the carrying amount of the asset and is recognised in the consolidated statement of profit and loss.

See Note 2A - Property, Plant and Equipment and Capital Work-in-Progress for further details.

See Note 33 - Depreciation and Amortization Expense for further details.

## E. Investment Property

Investment properties held to earn rentals or for capital appreciation or both are stated in the consolidated balance sheet at cost, less any subsequent accumulated depreciation and subsequent accumulated impairment losses. Depreciation is charged on a straight line basis over their estimated useful lives. Any gain or loss on disposal of investment property is determined as the difference between net disposal proceeds and the carrying amount of the property and is recognised in the consolidated statement of profit and loss. Transfer to, or from, investment property is at the carrying amount of the property.

See Note 3 - Investment Property for further details.

See Note 33 - Depreciation and Amortization Expense for further details.

## F. Intangible Assets (Other than goodwill)

### Intangible assets acquired separately

Intangible assets acquired are reported at cost less accumulated amortization and accumulated impairment losses. Amortization is charged on a straight line basis over their estimated useful lives other than 'Mining Rights' and 'Carbon Emission Rights'. The estimated useful life and amortization method are reviewed at the end of each annual reporting period, with the effect of any changes in estimate being accounted for on a prospective basis.

### Internally-generated intangible assets

Expenditure on research activities is recognized as an expense in the period in which it is incurred.

An internally-generated intangible asset arising from development (or from the development phase of an internal project) is recognized if, and only if all of the following have been demonstrated:

- the technical feasibility of completing the intangible asset so that it will be available for use or sale;

- management's intention to complete the intangible asset and use or sell it;
- the ability to use or sell the intangible asset;
- how the intangible asset will generate probable future economic benefits;
- the availability of adequate technical, financial and other resources to complete the development and to use or sell the intangible asset; and
- the ability to measure reliably the expenditure attributable to the intangible asset during its development.

The amount initially recognized for internally-generated intangible assets is the sum of the expenditure incurred from the date when the intangible asset is recognised. Where no internally-generated intangible asset can be recognized, development expenditure is charged to the consolidated statement of profit and loss in the period in which it is incurred.

Subsequent to initial recognition, internally-generated intangible assets are reported at cost less accumulated amortization and accumulated impairment losses, on the same basis as intangible assets acquired separately.

### Intangible assets acquired in a business combination

Identified intangible assets acquired in a business combination and recognised separately from goodwill are initially recognised at their fair values at the acquisition date.

Subsequent to initial recognition, intangible assets acquired in a business combination are reported at cost less accumulated amortization and accumulated impairment losses, on the same basis as intangible assets acquired separately.

### Mining Reserves, Resources and Rights (Mining Rights)

Mineral reserves, resources and rights (together referred to as 'mining rights') which can be reasonably valued, are recognised in the assessment of fair values on acquisition. Exploitable mineral rights are amortised using the unit of production basis over the commercially recoverable reserves. Mineral resources are included in amortisation calculations where there is a high degree of confidence that they will be extracted in an economic manner. Commercially recoverable reserves are proved and probable reserves. Changes in the commercial recoverable reserves affecting unit of production calculations are dealt with prospectively over the revised remaining reserves.

### Exploration for and evaluation of mineral resources

Expenditures associated with exploration for and evaluation of mineral resources after obtaining of legal

rights to explore a specific area but before technical feasibility and commercial viability of extracting mineral resources are demonstrable are recognized as Exploration and Evaluation assets.

If a project does not prove viable, all irrecoverable exploration and evaluation expenditure associated with the project net of any related impairment allowances is written off to the consolidated statement of profit and loss.

The Group measure its Exploration and Evaluation assets at cost and classifies it as Property, Plant and Equipment or Intangible Assets according to the nature of assets acquired and applies the classification consistently.

As the assets are not available for use, it is not depreciated but are monitored for indication of impairment. An exploration and evaluation asset is no longer classified as such when the technical feasibility and commercial viability of extracting minerals resources are demonstrable and the development of the deposit is intended by the management. The carrying value of such exploration and evaluation asset is reclassified as Mining Rights.

### Derecognition of intangible assets

An intangible asset is derecognised on disposal, or when no future economic benefits are expected from use or disposal. Gains or losses arising from derecognition of an intangible asset, measured as the difference between the net disposal proceeds and the carrying amount of the asset are recognised in the consolidated statement of profit and loss when the asset is derecognised.

Intangible assets with indefinite useful lives and intangible assets not yet available for use are tested for impairment annually, and whenever there is an indication that the asset may be impaired.

See Note 5 - Other Intangible Assets and Intangible Assets under Development for further details.

See Note 33 - Depreciation and Amortization Expense for further details.

## G. Stripping cost

Stripping costs incurred during the mining production phase are allocated between cost of inventory produced and the existing mine asset. The stripping ratio, as approved by the regulatory authority, for the life of the mine is obtained by dividing the estimated quantity of overburden by the estimated quantity of mineable coal / bauxite reserve to be extracted over the life of the mine. This ratio is periodically reviewed and changes, if any, are accounted for prospectively.

Stripping costs are allocated and included as a component of the mine asset when they represent significantly



# Notes

forming part of the Consolidated Financial Statements

improved access to ore, provided all the following conditions are met:

- it is probable that the future economic benefit associated with the stripping activity will be realised;
- the component of the ore body for which access has been improved can be identified; and
- the costs relating to the stripping activity associated with the improved access can be reliably measured.

The overburden removal costs are included in Mining Rights under Intangible assets and amortised based on stripping ratio on the quantity of coal / bauxite excavated.

See Note 5 - Other Intangible Assets and Intangible Assets under Development for further details.

See Note 33 - Depreciation and Amortization Expense for further details.

## H. Non-Current assets (or disposal groups) held for sale

Non-Current assets and disposal groups are classified as held for sale if their carrying amount will be recovered principally through a sale transaction rather than through continuing use. This condition is regarded as met only when the asset (or disposal group) is available for immediate sale in its present condition subject only to terms that are usual and customary for sales of such asset (or disposal group) and its sale is highly probable. Management must be committed to the sale, which should be expected to qualify for recognition as a completed sale within one year from the date of classification.

Non-Current assets (and disposal groups) classified as held for sale are measured at the lower of their carrying amount and fair value less costs to sell except for those assets that are specifically exempt under relevant Ind AS. Once the assets are classified as "Held for sale", those are not subjected to depreciation till disposal.

An impairment loss is recognised for any initial or subsequent write-down of the asset (or disposal group) to fair value less costs to sell. A gain is recognised for any subsequent increases in fair value less costs to sell of an asset (or disposal group), but not in excess of any cumulative impairment loss previously recognised.

A gain or loss not previously recognised by the date of the sale of the non-current asset (or disposal group) is recognised at the date of derecognition.

Non-current assets classified as held for sale and the assets of a disposal group classified as held for sale are presented separately from the other assets in the consolidated balance sheet.

### Discontinued Operations

A discontinued operation is a component of an entity that either has been disposed of, or is classified as held

for sale and that represents a separate line of business or geographical area of operations, is part of single coordinated plan to dispose of such a line of business or area of operations, or is a subsidiary acquired exclusively with a view to resale. The results of discontinued operations are presented separately in the consolidated statement of profit and loss.

See Note 15 - Non-Current Assets or Disposal Group Classified as Held For Sale for further details.

See Note 50 - Discontinued Operations for further details.

## I. Goodwill

Goodwill arising on acquisition is carried at cost as established at the date of acquisition of the business less accumulated impairment losses, if any.

For the purpose of impairment testing, goodwill is allocated to each of the Group's cash-generating units expected to benefit from the synergies of the combination.

Cash-generating units to which goodwill has been allocated are tested for impairment annually, or more frequently when there is an indication that the unit may be impaired. If the recoverable amount of the cash-generating unit is less than the carrying amount of the unit, the impairment loss is allocated first to reduce the carrying amount of any goodwill allocated to the unit and then to the other assets of the unit pro-rata on the basis of the carrying amount of each asset in the unit. An impairment loss recognised for goodwill is not reversed in a subsequent period.

On disposal of a subsidiary the attributable amount of goodwill is included in the determination of the profit or loss on disposal.

The Group's policy for goodwill arising on the acquisition of an associate is described above.

See Note 4 - Goodwill for further details.

## J. Impairment of Non-Current Assets (excluding Goodwill)

At the end of each reporting period, the Group reviews the carrying amounts of its tangible, intangible and other non-current assets to determine whether there is any indication that those assets have suffered an impairment loss. If any such indication exists, the recoverable amount of the asset/ cash-generating unit is estimated in order to determine the extent of the impairment loss (if any). Where it is not possible to estimate the recoverable amount of an individual asset, the Group estimates the recoverable amount of the cash-generating unit to which the asset belongs. Recoverable amount is the higher of fair value less cost to sell and Value in use. Where a reasonable and consistent basis of allocation can be identified, corporate assets are also allocated to individual

cash-generating units, or otherwise they are allocated to the group of cash-generating units for which a reasonable and consistent allocation basis can be identified.

Recoverable amount is the higher of fair value less costs to sell and value in use. In assessing value in use, the estimated future cash flows are discounted to their present value using a pre-tax discount rate that reflects current market assessments of the time value of money and the risks specific to the asset for which the estimates of future cash flows have not been adjusted.

If the recoverable amount of an asset (or cash-generating unit) is estimated to be less than its carrying amount, the carrying amount of the asset (or cash-generating unit) is reduced to its recoverable amount. An impairment loss is recognised immediately in the consolidated statement of profit and loss.

Non-current assets (other than Goodwill) that suffered an impairment are reviewed for possible reversal of the impairment at the end of each reporting period. Where an impairment loss subsequently reverses, the carrying amount of the asset (or cash-generating unit) is increased to the revised estimate of its recoverable amount, so that the increased carrying amount does not exceed the carrying amount that would have been determined had no impairment loss been recognised for the asset (or cash-generating unit) in prior years. A reversal of an impairment loss is recognised immediately in the consolidated statement of profit and loss.

Refer Note 1B (I.) on accounting policy on Goodwill for impairment of goodwill.

See Note 2 - Property, Plant and Equipment (including ROU Assets) and Capital Work-in-Progress for further details.

See Note 3 - Investment Property for further details.

See Note 5 - Other Intangible Assets and Intangible Assets under Development for further details.

See Note 34 - Impairment Loss/ (Reversal) of Non-Current Assets (Net) for further details.

## K. Foreign Currency Transactions and Translation

Transactions in foreign currencies are recorded by the group entities at their respective functional currency at the exchange rates prevailing at the date of the transaction first qualifies for recognition. Monetary assets and liabilities denominated in foreign currency are translated to the functional currency at the exchange rates prevailing at the reporting date.

Exchange differences arising on settlement or translation of monetary items are recognised in the consolidated statement of profit and loss with the exception of the following:

- eligible exchange differences on foreign currency borrowings relating to qualifying assets under construction are included in the cost of those assets when they are regarded as an adjustment to interest costs;
- exchange differences on transactions entered into in order to hedge certain foreign currency risks (see below for hedge accounting policies); and
- exchange differences on monetary items receivable from or payable to a foreign operation for which settlement is neither planned nor likely to occur (therefore forming part of the net investment in the foreign operation), which are recognised initially in other comprehensive income and reclassified from equity to the consolidated statement of profit and loss on repayment of the monetary items.

Non-monetary items that are measured at historical cost in a foreign currency are translated using the exchange rates at the date of initial transactions. Non-monetary items measured at fair value in a foreign currency are translated using the exchange rates at the date when the fair value is determined. The gain or loss arising on translation of non-monetary items measured at fair value is treated in line with the recognition of gain or loss on change in fair value of the item (i.e. translation differences on items whose fair value gain or loss is recognised in OCI or profit or loss are also recognised in OCI or profit or loss, respectively).

For the purposes of presenting consolidated financial statements, the assets, liabilities and equity (except retained earnings) of foreign operations are translated into Indian Rupees at the rate of exchange prevailing at the reporting date and their income and expenses are translated at the exchange rates prevailing at the date of transactions. For practical reason, the Group uses an average rate to translate income and expense items, if the average rate approximates the exchange rates at the dates of the transactions. The exchange differences arising on translation for consolidation are recognised in other comprehensive income and accumulated in equity. Accumulated exchange differences arising from translation and attributable to non-controlling interests are allocated to, and recognised as part of, non-controlling interests in the consolidated balance sheet.

On the disposal of a foreign operation all of the exchange differences accumulated in OCI relating to that particular foreign operation attributable to the owners of the Group is reclassified in the consolidated statement of profit and loss.

In addition, in relation to a partial disposal of a subsidiary that includes a foreign operation that does not result in the Group losing control over the subsidiary, the proportionate share of accumulated exchange differences

# Notes

forming part of the Consolidated Financial Statements

are re-attributed to non-controlling interests and are not recognised in the consolidated statement of profit and loss. For partial disposals of investment in associates or joint arrangements that do not result in the Group losing significant influence or joint control, the proportionate share of the accumulated exchange differences is reclassified in the consolidated statement of profit and loss.

Any goodwill and fair value adjustments arising in business combinations or acquisition of a foreign operation are treated as assets and liabilities of the foreign operation and translated at the exchange rates prevailing at the reporting date and resulting exchange differences are recognised in other comprehensive income.

See Note 32 - Finance Cost for further details.

See Note 36 - Other Expenses for further details.

See Note 38 - Other Comprehensive Income/ (Loss) for further details.

## L. Provisions and Contingencies

Provisions are recognized when there is a present obligation (legal or constructive) as a result of a past event and it is probable ("more likely than not") that it is required to settle the obligation, and a reliable estimate can be made of the amount of the obligation.

The amount recognised as a provision is the best estimate of the consideration required to settle the present obligation at the balance sheet date, taking into account the risks and uncertainties surrounding the obligation. Where a provision is measured using the estimated cash flows to settle the present obligation, its carrying amount is the present value of those cash flows. The discount rate used is a pre-tax rate that reflects current market assessments of the time value of money in that jurisdiction and the risks specific to the liability.

### Onerous contracts

Present obligations arising under onerous contracts are recognised and measured as provisions. An onerous contract is considered to exist when a contract under which the unavoidable costs of meeting the obligations exceed the economic benefits expected to be received from it.

### Restructurings

A restructuring provision is recognised when there is a detailed formal plan for the restructuring which has raised a valid expectation in those affected that the Group will carry out the restructuring by stating to implement the plan or announcing its main feature to those affected by it. The measurement of a restructuring provision includes only the direct expenditures arising from the restructuring

which are both necessarily entailed by the restructuring and not associated with the ongoing activities of the Group.

### Contingent liabilities acquired in a business combination

Contingent liabilities acquired in a business combination are initially measured at fair value at the acquisition date. At the end of subsequent reporting periods, such contingent liabilities are measured at the higher of the amount that would be recognised in accordance with Ind-AS 37 and the amount initially recognised less cumulative amortisation recognised in accordance with Ind AS 115 - Revenue from contracts with customers. This does not apply to financial guarantee contracts or otherwise to those contracts that are within the scope of Ind AS 109.

### Restoration (including Mine closure), rehabilitation and decommissioning

Close-down and restoration costs are provided for in the accounting period when the obligation arising from the related disturbance occurs, based on the net present value of the estimated future costs of restoration to be incurred during the life of the mining operation and post closure. Provisions for close-down and restoration costs do not include any additional obligations which are expected to arise from future disturbance.

The initial close-down and restoration provision is capitalised. Subsequent movements in the close-down and restoration provisions for ongoing operations, including those resulting from new disturbance related to expansions or other activities qualifying for capitalisation, updated cost estimates, changes to the estimated lives of operations, changes to the timing of closure activities and revisions to discount rates are also capitalised within "Property, plant and equipment".

### Environmental liabilities

Environment liabilities are recognised when the group becomes obliged, legally or constructively to rectify environmental damage or perform remediation work.

### Litigation

Provision relating to legal, tax and other matters is recognised once it has been established that the group has a present obligation based on consideration of the information which becomes available up to the date on which the consolidated financial statements of the Group are approved and may in some cases entail seeking expert advice in making the determination on whether there is a present obligation.

### Contingent Liabilities and Assets

A contingent liability is a possible obligation that arises from a past event, with the resolution of the contingency

dependent on uncertain future events, or a present obligation where no outflow is probable. Material contingent liabilities are disclosed in the consolidated financial statements unless the possibility of an outflow of economic resources is remote. Contingent assets are not recognized in the consolidated financial statements unless it is virtually certain that the future event will confirm the asset's existence and the asset will be realised.

### Enterprise Social Commitment

Enterprise Social Commitment is the amount to be spent on social and economic development of the surrounding area over a period of time where any new project is set up. Such obligation arises out of conditions mentioned in the Environment Clearance Certificate given by the Government for new projects and are generally defined as a percentage of total project cost. Present value of such future cash flows discounted at appropriate and applicable discount rates are capitalised against the obligation created. Actual cash flows that happen over the period are adjusted against the obligation. The obligation is increased over a period of time and the differential is recognized in the Statement of Profit and Loss as Interest Expense.

### Renewable Power Obligation

Provision towards Renewable Power obligation is created to the extent any obligated unit is unable to source renewable energy as a replacement to carbon energy as per requirement of the applicable regulation during the reporting period and is carried in books till the obligation is discharged by purchasing Renewable Energy Certificate from any of the authorised exchanges.

See Note 22 - Provisions for further details.

See Note 43 - Contingent Liabilities and Commitments for further details.

## M. Leases

### The Group as lessee

The Group assesses whether a contract is or contains a lease, at inception of the contract. The Group recognises a right-of-use asset and a corresponding lease liability with respect to all lease arrangements in which it is the lessee, except for short-term leases (defined as leases with a lease term of 12 months or less) and leases of low value assets. For these leases, the Group recognises the lease payments as an operating expense on a straight-line basis over the lease term, unless another systematic basis is more representative of the time pattern in which economic benefits from the leased assets are consumed. Contingent and variable rentals are recognized as expense in the periods in which they are incurred.

### Lease Liability

The lease payments that are not paid at the commencement date are discounted using the interest rate implicit in the lease. If that rate cannot be readily determined, which is generally the case for leases in the Group, the lessee's incremental borrowing rate is used, being the rate that the individual lessee would have to pay to borrow the funds necessary to obtain an asset of similar value to the right-of-use asset in a similar economic environment with similar terms, security and conditions.

To determine the incremental borrowing rate, the Group uses a build-up approach that starts with a risk-free interest rate adjusted for credit risk and makes adjustments specific to the lease, e.g. term, security etc.

Lease payments included in the measurement of the lease liability comprise:

- Fixed lease payments (including in-substance fixed payments) payable during the lease term and under reasonably certain extension options, less any lease incentives;
- Variable lease payments that depend on an index or rate, initially measured using the index or rate at the commencement date;
- The amount expected to be payable by the lessee under residual value guarantees;
- The exercise price of purchase options, if the lessee is reasonably certain to exercise the options; and
- Payments of penalties for terminating the lease, if the lease term reflects the exercise of an option to terminate the lease.

The lease liability is presented as a separate line in the consolidated Balance Sheet.

The lease liability is subsequently measured by increasing the carrying amount to reflect interest on the lease liability (using the effective interest method) and by reducing the carrying amount to reflect the lease payments made.

The Group remeasures the lease liability (and makes a corresponding adjustment to the related right-of-use asset) to reflect any reassessment, lease modification or revised in-substance fixed lease payments.

### Right of Use (ROU) Assets

The ROU assets comprise the initial measurement of the corresponding lease liability, lease payments made at or before the commencement day and any initial direct costs. They are subsequently measured at cost less accumulated depreciation and impairment losses.

Whenever the Group incurs an obligation for costs to dismantle and remove a leased asset, restore the site on which it is located or restore the underlying asset to the



# Notes

forming part of the Consolidated Financial Statements

condition required by the terms and conditions of the lease, a provision is recognised and measured under Ind AS 37- Provisions, Contingent Liabilities and Contingent Assets. The costs are included in the related right-of-use asset.

For the certain class of assets, the Group allocates lease or non-lease components on the basis of their relative stand-alone prices while assessing a contract at its inception or on reassessment.

The Group applies Ind AS 36 - Impairment of Assets to determine whether a right-of-use asset is impaired and accounts for any identified impairment loss as per its accounting policy on 'Property, Plant and Equipment'.

Extension and termination options are included in many of the leases. In determining the lease term the management considers all facts and circumstances that create an economic incentive to exercise an extension option, or not exercise a termination option.

ROU assets are depreciated over the shorter period of the lease term and useful life of the underlying asset. If the Group is reasonably certain to exercise a purchase option, the right-of-use asset is depreciated over the underlying asset's useful life. The depreciation starts at the commencement date of the lease.

Deferred tax on the deductible temporary difference and taxable temporary differences in respect of carrying value of right of use assets and lease liability and their respective tax bases are recognised separately.

## Sale and Leaseback

When Group (seller-lessee) sells an asset to another entity (the buyer-lessor) and leases it back from the buyer lessor, the Group determines if the transaction qualifies as a sale under Ind AS 115 or whether the transaction is a collateralised borrowing.

A sale and leaseback qualifies as a sale if the buyer-lessor obtains control of the underlying asset. The Group measures a right-of-use asset arising from the leaseback as the proportion of the previous carrying amount of the asset that relates to the right-of-use retained. The gain/ (loss) that the Group recognises is limited to the proportion of the total gain/ (loss) that relates to the rights transferred to the buyer-lessor.

Any difference between the sale consideration and the fair value of the asset is either a prepayment of lease payments (if the purchase price is below market terms) or an additional financing (if the purchase price is above market terms), and this is applied if the lease payments are not at market rates.

If the transfer does not qualify as a sale under Ind AS 115, the Group does not derecognise the transferred asset, and it accounts for the cash received as a financial liability.

## The Group as lessor

The Group enters into lease arrangements as a lessor with respect to some of its investment properties and buildings.

Leases for which the Group is a lessor are classified as finance or operating leases. Whenever the terms of the lease transfer substantially all the risks and rewards of ownership to the lessee, the contract is classified as finance lease. All other leases are classified as operating leases.

When the Group is an intermediate lessor, it accounts for the head lease and sublease as two separate contracts. The sublease is classified as finance or operating lease by reference to the right-of-use asset arising from the head lease.

Rental income from operating leases is recognised on a straight-line basis over the term of the relevant lease. Initial direct costs incurred in negotiating and arranging an operating lease are added to the carrying amount of the leased asset and recognised on a straight-line basis over the lease term.

Amounts due from lessees under finance leases are recognised as receivables at the amount of the Group's net investment in the leases. Finance lease income is allocated to accounting periods so as to reflect a constant periodic rate of return on the Group's net investment outstanding in respect of the leases.

When a contract includes lease and non-lease components, the Group applies Ind AS 115, Revenue from Contracts with Customers to allocate the consideration under the contract to each component.

See Note 2 - Property, Plant and Equipment (including ROU Assets) and Capital Work-in-Progress and Note 36 - Other Expenses for further details.

See Note 2C - Lease Liabilities recognised against Right of Use assets for further details.

## N. Inventories

Inventories are stated at the lower of cost and net realizable value. The cost of finished goods and work in progress includes raw materials, direct labour, other direct costs and related production overheads. Costs of inventories include the transfer from equity any gains/ losses on qualifying cash flow hedges for purchases of raw materials.

Cost of raw material and traded goods comprises of Cost of purchases and also include all other costs incurred in bringing the inventories to their present location and condition and are net of rebates and discounts.

The Inventories are measured at Fair Value only in those cases where the Inventories are designated into a fair value hedge relationship.

Cost is determined using the weighted average cost basis. However, the same cost basis is applied to all inventories of a particular class. Inventories of stores and spare parts are valued at weighted average cost basis after providing for cost of obsolescence and other anticipated losses, wherever considered necessary.

Net realizable value represents the estimated selling price for inventories less all estimated costs of completion and costs necessary to make the sale.

Materials and other supplies held for use in the production of inventories (finished goods, work-in-progress) are not written down below the cost if the finished products in which they will be used are expected to sell at or above cost.

See Note 11 - Inventories for further details.

## O. Trade Receivable

Trade receivables are amounts due from customers for goods sold or services performed in the ordinary course of business. If receivable is expected to be collected within a period of 12 months or less from the reporting date (or in the normal operating cycle of the business if longer), they are classified as Current Assets otherwise as Non-Current Assets.

Trade receivables are measured at their transaction price on initial recognition, unless it contains a significant financing component or pricing adjustments embedded in the contract. Trade receivables are held with the objective of collecting the contractual cash flows and therefore are subsequently measured at amortised cost less loss allowance.

Trade receivables which are subject to a factoring arrangement without recourse are de-recognized from the consolidated balance sheet. Under this arrangement, the Group transfers relevant receivables to the factor in exchange for cash and does not retain late payment and credit risk.

Trade receivables which arise from contracts where the sale price is provisional and revenue model have the character of a commodity derivative are measured at fair value. The fair value is measured at forward rate and subsequent changes are recognised as Other Operating Revenue.

See Note 12 - Trade Receivables for further details.

## P. Trade and Other Payables

These amounts represent liabilities for goods and services provided to the Group and are unpaid at the end of the

financial year. The amounts are unsecured and usually paid within time limits as contracted. Trade and other payables are presented as current liabilities unless the payment is not due within 12 months after the reporting period.

They are recognised initially at their transactional value which represents the fair value and subsequently measured at amortised cost using the effective interest method wherever applicable.

See Note 20 - Trade Payables for further details.

## Q. Financial Instruments

All financial assets are recognised on trade date when the purchase of a financial asset is under a contract whose term requires delivery of the financial asset within the timeframe established by the market concerned. Financial assets are initially measured at fair value, plus transaction costs, except for those financial assets which are classified as at fair value through profit or loss (FVTPL) at inception. All recognised financial assets are subsequently measured in their entirety at either amortised cost or fair value.

### Classification of financial assets

Financial assets are classified as 'equity instrument' if it is a non-derivative and meets the definition of 'equity' for the issuer. All other non-derivative financial assets are 'debt instruments'.

### Financial assets at amortised cost and the effective interest method

Debt instruments are measured at amortised cost if both of the following conditions are met:

- the asset is held within a business model whose objective is to hold assets in order to collect contractual cash flows; and
- the contractual terms of the instrument give rise on specified dates to cash flows that are solely payments of principal and interest on the principal amount outstanding.

Debt instruments meeting these criteria are subsequently measured at amortised cost using the effective interest method less any impairment, with interest recognised on an effective yield basis in investment income.

The effective interest method is a method of calculating the amortised cost of a debt instrument and of allocating interest over the relevant period. The effective interest rate is the rate that exactly discounts the estimated future cash receipts (including all fees or points paid or received that form an integral part of the effective interest rate, transaction costs and other premiums or discounts) through the expected life of the debt instrument, or (where appropriate) a shorter period, to the net carrying amount on initial recognition.

# Notes

forming part of the Consolidated Financial Statements

The Group may irrevocably elect at initial recognition to classify a debt instrument that meets the amortised cost criteria above as at FVTPL if that designation eliminates or significantly reduces an accounting mismatch had the financial asset been measured at amortised cost.

## **Financial assets at fair value through other comprehensive income (FVTOCI)**

Debt instruments are measured at FVTOCI if both of the following conditions are met:

- the asset is held within a business model whose objective is to hold assets in order to collect contractual cash flows and selling assets; and
- the contractual terms of the instrument give rise on specified dates to cash flows that are solely payments of principal and interest on the principal amount outstanding

Debt instruments meeting these criteria are subsequently measured at fair value with any gains or losses arising on re-measurement recognised in other comprehensive income, except for impairment gains or losses, interest gain and foreign exchange gains or losses which are recognised in the Consolidated statement of profit and loss. Interest calculated using the effective interest method is recognised in the Consolidated statement of profit and loss as investment income. When the debt instrument is derecognised the cumulative gain or loss previously recognised in other comprehensive income is reclassified to the Consolidated statement of profit and loss as a reclassification adjustment.

At initial recognition, an irrevocable election is made (on an instrument-by-instrument basis) to designate investments in equity instruments (other than held for trading purpose) at FVTOCI.

A financial asset is held for trading if:

- it has been acquired principally for the purpose of selling it in the near term; or
- on initial recognition it is part of a portfolio of identified financial instruments that the Group manages together and has evidence of a recent actual pattern of short-term profit-taking; or
- it is a derivative that is not designated in an effective hedge relationship as a hedging instrument or a financial guarantee.

Investments in equity instruments at FVTOCI are subsequently measured at fair value with gains and losses arising from changes in fair value recognised in other comprehensive income and accumulated in the 'Gain/ (Loss) on Equity Instruments FVTOCI'. Where the asset is disposed of, the cumulative gain or loss previously accumulated in the 'Gain/ (Loss) on Equity Instruments FVTOCI' is directly reclassified to retained earnings.

For equity instruments measured at fair value through other comprehensive income no impairments are recognised in the Consolidated statement of profit and loss.

Dividends on these investments in equity instruments are recognised in the Consolidated statement of profit and loss in investment income when the Group's right to receive the dividends is established, it is probable that the economic benefits associated with the dividend will flow to the entity; and the amount of the dividend can be measured reliably.

## **Financial assets at fair value through profit and loss (FVTPL)**

Financial assets that do not meet the criteria of classifying as amortised cost or fair value through other comprehensive income described above, or that meet the criteria but the entity has chosen to designate as at FVTPL at initial recognition, are measured at FVTPL.

Investments in equity instruments are classified as at FVTPL, unless the Group designates an investment that is not held for trading at FVTOCI at initial recognition.

Financial assets at FVTPL are subsequently measured at fair value, with any gains or losses arising on re-measurement recognised in the Consolidated statement of profit and loss. Interest income from these financial assets is included in other income.

Dividend income on investments in equity instruments at FVTPL is recognised in the Consolidated statement of profit and loss in investment income when the Group's right to receive the dividends is established, it is probable that the economic benefits associated with the dividend will flow to the entity, and the amount of the dividend can be measured reliably.

## **Impairment of financial assets**

On initial recognition of the financial assets, a loss allowance for expected credit loss is recognised for debt instruments at amortised cost and FVTOCI. For debt instruments that are measured at FVTOCI, the loss allowance is recognised in the Consolidated statement of profit and loss.

Expected credit losses of a financial instrument is measured in a way that reflects:

- an unbiased and probability-weighted amount that is determined by evaluating a range of possible outcomes;
- the time value of money; and
- reasonable and supportable information that is available without undue cost or effort at the reporting date about past events, current conditions and forecasts of future economic conditions.

At each reporting date, the Group assesses whether the credit risk on a financial instrument has increased significantly since initial recognition.

When making the assessment, the Group compares the risk of a default occurring on the financial instrument as at the reporting date with the risk of a default occurring on the financial instrument as at the date of initial recognition and consider reasonable and supportable information, that is available without undue cost or effort, that is indicative of significant increases in credit risk since initial recognition.

If, at the reporting date, the credit risk on a financial instrument has not increased significantly since initial recognition, the Group measures the loss allowance for that financial instrument at an amount equal to 12-month expected credit losses. If, the credit risk on that financial instrument has increased significantly since initial recognition, the Group measures the loss allowance for a financial instrument at an amount equal to the lifetime expected credit losses.

For Trade Receivables and Contract Assets, the Group applies the simplified approach required by Ind AS 109, which requires expected life time losses to be recognized from initial recognition of the receivables.

The amount of expected credit losses (or reversal) that is required to adjust the loss allowance at the reporting date is recognised as an impairment gain or loss in the Consolidated statement of profit and loss.

## **De-recognition of financial assets**

The Group derecognises a financial asset on trade date only when the contractual rights to the cash flows from the asset expire, or when it transfers the financial asset and substantially all the risks and rewards of ownership of the asset to another entity or when it retains contractual rights to retain contractual cash flows from financial assets, but assumes a contractual obligation to pay the cash flows to one or more recipient. If the Group neither transfers nor retains substantially all the risks and rewards of ownership and continues to control the transferred asset, the Group recognises its retained interest in the asset and an associated liability for amounts it may have to pay. If the Group retains substantially all the risks and rewards of ownership of a transferred financial asset, the Group continues to recognise the financial asset and also recognises a collateralised borrowing for the proceeds received.

On de-recognition of a financial asset other than in its entirety (e.g. when the Group retains an option to repurchase part of a transferred asset), the Group allocates the previous carrying amount of the financial asset between the part it continues to recognise under continuing involvement, and the part it no longer

recognises on the basis of the relative fair values of those parts on the date of the transfer. The difference between the carrying amount allocated to the part that is no longer recognised and the sum of the consideration received for the part no longer recognised and any cumulative gain or loss allocated to it that had been recognised in other comprehensive income is recognised in the Consolidated statement of profit and loss. A cumulative gain or loss that had been recognised in other comprehensive income is allocated between the part that continues to be recognised and the part that is no longer recognised on the basis of the relative fair values of those parts.

## **Financial liabilities and equity instruments issued by the Group**

### **Classification as debt or equity**

Debt and equity instruments are classified as either financial liabilities or as equity in accordance with the substance of the contractual arrangement.

### **Equity instruments**

An equity instrument is any contract that evidences a residual interest in the assets of an entity after deducting all of its liabilities. Equity instruments issued by the Group are recognised at the proceeds received, net of direct issue costs.

### **Compound instruments**

The component parts of compound instruments (convertible instruments) issued by the Group are classified separately as financial liabilities and equity in accordance with the substance of the contractual arrangement. At the date of issue, the fair value of the liability component is estimated using the prevailing market interest rate for a similar non-convertible instrument. This amount is recorded as a liability on an amortised cost basis using the effective interest method until extinguished upon conversion or at the instrument's maturity date. The equity component is determined by deducting the amount of the liability component from the fair value of the compound instrument as a whole. This is recognised and included in equity, net of income tax effects, and is not subsequently re-measured.

### **Financial guarantee contract liabilities**

Financial guarantee contract liabilities are initially measured at their fair values and, if not designated as at FVTPL, are subsequently measured at the higher of:

- the amount of loss allowance is determined by using expected credit loss model; and
- the amount initially recognised less, where appropriate, cumulative amount of income recognised in accordance with the revenue recognition policies.



# Notes

forming part of the Consolidated Financial Statements

## Financial liabilities

Financial liabilities are classified as either financial liabilities 'at FVTPL' or 'other financial liabilities'.

### Financial liabilities at FVTPL

Financial liabilities are classified as at FVTPL when the financial liability is either held for trading or it is designated as at FVTPL.

A financial liability is classified as held for trading if:

- it has been acquired or incurred principally for the purpose of repurchasing it in the near term; or
- on initial recognition it is part of a portfolio of identified financial instruments that the Group manages together and for which there is evidence of a recent actual pattern of short-term profit-taking; or
- it is a derivative that is not designated and effective as a hedging instrument.

A financial liability other than a financial liability held for trading may also be designated as at FVTPL upon initial recognition if:

- such designation eliminates or significantly reduces a measurement or recognition inconsistency that would otherwise arise; or
- the financial liability forms part of a group of financial assets or financial liabilities or both, which is managed and its performance is evaluated on a fair value basis, in accordance with the Group's documented risk management or investment strategy, and information about the Group is provided internally on that basis; or
- it forms part of a contract containing one or more embedded derivatives, and Ind-AS 109 Financial Instruments permits the entire combined contract to be designated as at FVTPL.

Financial liabilities at FVTPL are stated at fair value, with any gains or losses arising on re-measurement recognised in the Consolidated statement of profit and loss, except for the amount of change in the fair value of the financial liability that is attributable to changes in the credit risk of that liability which is recognised in other comprehensive income.

The net gain or loss recognised in the Consolidated statement of profit and loss incorporates any interest paid on the financial liability.

### Other financial liabilities

Other financial liabilities, including borrowings, are initially measured at fair value, net of transaction costs.

Other financial liabilities are subsequently measured at

amortised cost using the effective interest method, with interest expense recognised on an effective yield basis.

The effective interest method is a method of calculating the amortised cost of a financial liability and of allocating interest expense over the relevant period. The effective interest rate is the rate that exactly discounts estimated future cash payments through the expected life of the financial liability, or (where appropriate) a shorter period, to the net carrying amount on initial recognition.

### Offsetting financial instruments

Financial assets and liabilities are offset and the net amount reported in the Consolidated balance sheet when there is a legally enforceable right to offset the recognised amounts and there is an intention to settle on a net basis or realise the asset and settle the liability simultaneously. The legally enforceable right must not be contingent on future events and must be enforceable in the normal course of business and in the event of default, insolvency or bankruptcy of the Group or the counterparty.

See Note 6A & 6B - Investments for further details.

See Note 7 - Loans for further details.

See Note 8A & 8B - Other Financial Assets for further details.

See Note 14 - Bank Balances other than Cash and Cash Equivalents for further details.

See Note 18A & 18B - Borrowings for further details.

See Note 26 - Other Income for further details.

See Note 35 - Impairment Loss/ (Reversal) on Financial Assets (Net) for further details.

See Note 45 - Financial Instruments for further details.

See Note 46 - Financial Risk Management and Derivative Financial Instruments for further details.

See Note 47 - Offsetting for further details.

## R. Derivatives and Hedge Accounting

Derivatives are initially recognised at fair value on the date a derivative contract is entered into and are subsequently re-measured at their fair value at the end of each reporting date. The method of recognising the resulting gain or loss depends on whether the derivative is designated as a hedging instrument, and if so, the nature of the item being hedged.

The Group designates certain derivatives as either:

- hedges of the fair value of recognised assets or liabilities or a firm commitment (fair value hedge);
- hedges of a particular risk associated with the cash flow of recognised assets or liabilities or a highly probable forecast transaction (cash flow hedge); or

The Group documents at the inception of the transaction the relationship between hedging instruments and hedged items, as well as its risk management objectives and strategy for undertaking various hedging transactions. The Group also documents the nature of the risk being hedged and how the Group will assess whether the hedging relationship meets the hedge effectiveness requirements (including its analysis of the sources of hedge ineffectiveness and how it determines the hedge ratio).

Change in Fair value of derivatives that are not designated in any hedge relationship as mentioned above are accounted through the Consolidated Statement of Profit and Loss at each reporting date.

The Group also identifies embedded derivatives in certain transactions. These derivatives are generally segregated from the host transactions and accounted for separately. These derivatives are designated into a hedge relationship if they meet hedge accounting criteria. Change in fair value of such embedded derivatives are accounted in Other Comprehensive Income if they are designated in a cash flow hedge relationship. Fair Value change of all other embedded derivatives including those that are not designated in any hedge relationship are accounted through the Consolidated Statement of Profit and Loss.

The full fair value of a hedging derivative is classified as a Non-Current asset or liability when the residual maturity of the derivative is more than 12 months and as a current asset or liability when the residual maturity of the derivative is less than 12 months.

### Fair value hedge

Changes in the fair value of derivatives that are designated and qualify as fair value hedges are recorded in the Consolidated statement of profit and loss, together with any changes in the fair value of the hedged item that are attributable to the hedged risk.

Hedge accounting is discontinued when the hedging instrument expires or is sold, terminated, or exercised, or when it no longer qualifies for hedge accounting. The fair value adjustment to the carrying amount of the hedged item arising from the hedged risk is amortised to the Consolidated Statement of Profit and Loss from that date except for inventory that is charged to the Consolidated Statement of Profit and Loss on sale of goods.

### Cash flow hedges

The effective portion of changes in the fair value of derivatives that are designated and qualify as cash flow hedges is recognised in other comprehensive income and accumulated under the heading cash flow hedging reserve within equity. The gain or loss relating to the ineffective portion is recognised immediately in the Consolidated

statement of profit and loss, and is included in the '(Gain) / Loss in Fair Value of Derivatives' line item.

Amounts previously recognised in other comprehensive income and accumulated in equity are reclassified to the Consolidated statement of profit and loss in the periods when the hedged item affects the Consolidated statement of profit and loss, in the same line as the recognised hedged item. However, when the hedged forecast transaction results in the recognition of a non-financial asset or a non-financial liability, the gains and losses previously recognised in other comprehensive income and accumulated in equity are transferred from equity and included in the initial measurement of the cost of the non-financial asset or non-financial liability as a basis adjustment.

If the hedge ratio for risk management purposes is no longer optimal but the risk management objective remains unchanged and the hedge continues to qualify for hedge accounting, the hedge relationship will be rebalanced by adjusting either the volume of the hedging instrument or the volume of the hedged item so that the hedge ratio aligns with the ratio used for risk management purposes. Any hedge ineffectiveness is calculated and accounted for in the Consolidated statement of profit and loss at the time of the hedge relationship rebalancing.

Hedge accounting is discontinued when the hedging instrument expires or is sold, terminated, or exercised, or when it no longer qualifies for hedge accounting. Any gain or loss recognised in other comprehensive income and accumulated in equity at that time remains in equity and is recognised when the forecast transaction is ultimately recognised in the Consolidated statement of profit and loss. When a forecast transaction is no longer expected to occur, the gain or loss accumulated in equity is recognised immediately in the Consolidated statement of profit and loss.

See Note 46 - Financial Risk Management and Derivative Financial Instruments for further details.

## S. Cash and Cash Equivalents

Cash and cash equivalents comprise of cash at bank and in hand, short-term deposits and short term highly liquid investments with an original maturity of three months or less that are readily convertible to known amounts of cash and are subject to insignificant risk of changes in value.

For the purposes of the consolidated statement of cash flow, cash and cash equivalents is as defined above, net of outstanding bank overdrafts which are integral part of Cash management activities. In the consolidated balance sheet, bank overdrafts are shown within borrowings in current liabilities.

See Note 13 - Cash and Cash Equivalents for further details.

# Notes

forming part of the Consolidated Financial Statements

## T. Borrowing cost

General and specific borrowing costs directly attributable to the acquisition, construction or production of qualifying assets are added to the cost of those assets, until such time as the assets are substantially ready for their intended use or sale. The Group considers a period of twelve months or more as a substantial period of time. Qualifying assets are assets that necessarily take a substantial period of time to get ready for their intended use or sale.

Transaction cost in respect of long-term borrowings are amortised over the tenure of respective loans using effective interest method. All other borrowing costs are expensed in the period in which they are incurred.

Investment income earned on the temporary investment of specific borrowings pending their expenditure on qualifying assets is deducted from the borrowing costs eligible for capitalization.

See Note 2 - Property, Plant and Equipment (including ROU Assets) and Capital Work-in-Progress for further details.

See Note 5 - Other Intangible Assets and Intangible Assets under Development for further details.

See Note 32 - Finance Cost for further details.

## U. Accounting for Government Grants

Government grants are recognized when there is reasonable assurance that the Group will comply with the conditions attaching to them and that the grants will be received.

Government grants are recognised in the consolidated statement of profit and loss on a systematic basis over the periods in which the Group recognises as expenses the related costs for which the grants are intended to compensate. Government grants whose primary condition is that the Group should purchase, construct or otherwise acquire Non-Current assets are recognized in the consolidated balance sheet by setting up the grant as deferred income and its amortization is recognised in 'Other Income' on straight line basis over expected useful lives of related assets.

Other government grants (grants related to income) are recognized as income over the periods necessary to match them with the costs for which they are intended to compensate, on a systematic basis. Government grants that are receivable as compensation for expenses or losses already incurred or for the purpose of providing immediate financial support with no future related costs are recognized in the Consolidated statement of profit and loss in the period in which they become receivable.

Grants related to income are presented under Other Income or Other Operating Revenue in the Consolidated

statement of profit and loss depending upon the nature of the underlying grant, except for grants received in the form of rebate or exemptions related to expenditures, which are deducted in reporting the related expense.

The benefit of a government loan at a below-market rate of interest is treated as a government grant, measured as the difference between proceeds received and the fair value of the loan based on prevailing market interest rates.

Emission allowances are initially recognised as an intangible asset measured at fair value when the Group is granted the allowances and able to exercise control with a corresponding recognition of a grant at the same amount under deferred income. As carbon dioxide is emitted, the corresponding tons of emission allowances initially recognised under deferred income is reclassified and recognized in the Consolidated statement of profit and loss on a systematic basis.

Emission allowances are not amortised as their carrying value equals their residual value and therefore the depreciable basis zero, as their value is constant until delivery to the authorities. Emission allowances are subject to impairment test.

The provision for the liability to deliver allowances is recognised based on actual emission. The provision is measured at the carrying amount of allowances to the extent that the provision will be settled using allowances on hand with any excess emission being measured at the market value of the allowances at the period end. The group records the expense in the Consolidated statement of profit and loss under other expenses.

When the emission allowances for the carbon dioxide emitted are delivered to the authorities, the intangible asset as well as the corresponding provision are de-recognized from the Consolidated balance sheet without any effect on the Consolidated statement of profit and loss.

See Note 25 - Revenue from Operations for further details.

See Note 26 - Other Income for further details.

## V. Employee Benefits

### *Retirement benefit, medical costs and termination benefits*

A defined contribution plan is a pension plan under which the group pays fixed contributions into a separate entity. The Group has no legal or constructive obligations to pay further contributions if the fund does not hold sufficient assets to pay all employees the benefits relating to employee service in the current and prior periods. Payments to defined contribution retirement benefit plans are recognised as an expense when employees have rendered service entitling them to the contributions.

For defined benefit retirement and medical plans, the cost of providing benefits is determined using the projected unit credit method, with actuarial valuations being carried out at the end of each annual reporting period. The present value of the defined benefit obligation is determined by discounting the estimated future cash outflows using market yields of government bonds having terms approximating to the terms of related obligation. In countries where there is a deep market in high-quality corporate bonds, the market rate on those bonds that are denominated in the currency in which the benefits will be paid, and that have terms to maturity approximating to the terms of the related pension obligation are used.

Re-measurement, comprising of actuarial gains and losses, the effect of the changes to the asset ceiling (if applicable) and the return on plan assets (excluding interest), is reflected in the Consolidated balance sheet with a charge or credit recognised in other comprehensive income in the period in which they occur. Re-measurement recognised in other comprehensive income is reflected immediately in retained earnings and will not be reclassified to the Consolidated statement of profit and loss. Past service cost is recognised in the Consolidated statement of profit and loss in the period of a plan amendment. Net interest is calculated by applying the discount rate at the beginning of the period to the net defined benefit liability or asset. Defined benefit costs are categorised as follows:

- service cost (including current service cost, past service cost, as well as gains and losses on curtailments and settlements);
- net interest expense or income; and
- re-measurement.

The Group presents the first two components of defined benefit costs in the Consolidated statement of profit and loss in the line item employee benefits expense. Curtailment gains and losses are accounted for as past service costs.

The retirement benefit obligation recognised in the Consolidated balance sheet represents the actual deficit or surplus in the Group's defined benefit plans. Any surplus resulting from this calculation is limited to the present value of any economic benefits available in the form of refunds from the plans or reductions in future contributions to the plans.

A liability for a termination benefit is recognised at the earlier of when the Group can no longer withdraw the offer of the termination benefit or when the entity recognises any related restructuring costs which involves the payment of terminations benefits.

In the case of an offer made to encourage voluntary redundancy, the termination benefits are measured based on the number of employees expected to accept the offer.

Benefits falling due more than 12 months after the end of the reporting period are discounted to their present value.

### *Short-term and other long-term employee benefits*

A liability is recognised for benefits accruing to employees in respect of wages and salaries in the period the related service is rendered at the undiscounted amount of the benefits expected to be paid in exchange for that service.

Liabilities recognised in respect of short-term employee benefits are measured at the undiscounted amount of the benefits expected to be paid in exchange for the related service.

Liabilities recognised in respect of other long-term employee benefits such as annual leave and sick leave are measured at the present value of the estimated future cash outflows expected to be made by the Group in respect of services provided by employees up to the reporting date. The expected costs of these benefits are accrued over the period of employment using the same accounting methodology as used for defined benefit retirement plans. Actuarial gains and losses arising from experience adjustments and changes in actuarial assumptions are charged or credited to the Consolidated statement of profit and loss in the period in which they arise. These obligations are valued annually by independent qualified actuaries.

See Note 30 - Employee Benefits for further details.

## W. Employee Share-based Payments

Equity-settled share-based payments to employees are measured at the fair value of options at the grant date.

The fair value of options at the grant is expensed over the respective vesting period in which all of the specified vesting conditions are to be satisfied with a corresponding increase in equity as "Employee Stock Options Account". In case of forfeiture of unvested option, portion of amount already expensed is reversed. In a situation where the vested options are forfeited or expires unexercised, the related balance standing to the credit of the "Employee Stock Options Account" are transferred to the "Retained Earnings".

When the options are exercised, the Company issues new equity shares of the Company of ₹ 1/- each fully paid-up. The proceeds received and the related balance standing to credit of the Employee Stock Options Account are credited to share capital (nominal value) and Securities Premium Account.

Share appreciation rights which are cash settled, are recognised as employee benefit expense over the relevant service period. The liability is fair valued at each reporting date and are presented as employee benefit obligations in the consolidated balance sheet.



# Notes

forming part of the Consolidated Financial Statements

See Note 41 - Employee Share-Based Payments for further details.

## X. Income Taxes

Income tax expense represents the sum of the tax currently payable and deferred tax.

### Current tax

The tax currently payable is based on taxable profit for the year. Taxable profit differs from 'profit before tax' as reported in the Consolidated statement of profit and loss because of items of income or expense that are taxable or deductible in other years and items that are never taxable or deductible. The current income tax charge is calculated on the basis of the tax laws enacted or substantively enacted at the balance sheet date in the countries where the Group's entities operate and generate taxable income using tax rates that have been enacted or substantively enacted by the end of the reporting period.

### Deferred tax

Deferred tax is recognised on differences between the carrying amounts of assets and liabilities in the consolidated balance sheet and the corresponding tax bases used in the computation of taxable profit. Where the local currency is not the functional currency, deferred tax is recognised on temporary difference arising from exchange rate changes between the closing rate and the historical purchase price of non-monetary assets translated at the exchange rate at the date of purchase if those non-monetary assets have tax consequences.

Deferred tax liabilities are generally recognised for all taxable temporary differences.

Deferred tax assets are generally recognised for all deductible temporary differences to the extent that it is probable that taxable profits will be available against which those deductible temporary differences can be utilised. Such assets and liabilities are not recognised if the temporary difference arises from initial recognition of goodwill or from the initial recognition (other than in a business combination) of other assets and liabilities in a transaction that affects neither the taxable profit nor the accounting profit.

Deferred tax liabilities are recognised for taxable temporary differences associated with investments in subsidiaries and associates, and interests in joint arrangements, except where the Group is able to control the reversal of the temporary difference and it is probable that the temporary difference will not reverse in the foreseeable future. Deferred tax assets arising from deductible temporary differences associated with such investments and interests are only recognised to the extent that it is probable that there will be sufficient

taxable profits against which to utilise the benefits of the temporary differences and they are expected to reverse in the foreseeable future. Generally, the group is unable to control the reversal of the temporary difference for associates.

The carrying amount of deferred tax assets is reviewed at each balance sheet date and reduced to the extent that it is no longer probable that sufficient taxable profits will be available to allow all or part of the asset to be recovered.

Deferred tax assets and liabilities are measured at the tax rates that are expected to apply in the period in which the liability is settled or the asset realised, based on tax rates (and tax laws) that have been enacted or substantively enacted by the balance sheet date. The measurement of deferred tax liabilities and assets reflects the tax consequences that would follow from the manner in which the Group expects, at the reporting date, to recover or settle the carrying amount of its assets and liabilities.

Deferred tax assets and liabilities are offset when there is a legally enforceable right to set off when they relate to income taxes levied by the same taxation authority. Current tax assets and current tax liabilities are offset where the Group has legally enforceable right and intends to settle on a net basis, or to realise the asset and settle the liability simultaneously.

Minimum Alternative Tax (MAT) is recognized as an asset only when and to the extent there is convincing evidence that the Group will pay normal income tax during the specified period. In the year in which the MAT credit becomes eligible to be recognized as an asset, the said asset is created by way of credit to the consolidated statement of profit and loss and included in deferred tax assets. The Group reviews the same at each balance sheet date and writes down the carrying amount of MAT entitlement to the extent there is no longer convincing evidence to the effect that Group will pay normal income tax during the specified period.

### Current and deferred tax for the period

Current and deferred tax are recognised in the Consolidated statement of profit and loss, except when they relate to items that are recognised in other comprehensive income or directly in equity, in which case, the current and deferred tax are also recognised in other comprehensive income or directly in equity, respectively. Where current tax or deferred tax arises from the initial accounting for a business combination, the tax effect is included in the accounting for the business combination.

The Group applies significant judgement in identifying uncertainties over income tax treatments. Uncertain tax positions are reflected in the overall measurement of tax expense of respective group entities and are based on the most likely amount or the expected value arrived at by

the Group companies which provides better prediction of the resolution of uncertainty. Uncertain tax positions are monitored and updated as and when new information becomes available, typically upon examination or action by the taxing authorities or through statute expiration and judicial precedent.

The Group considers when a particular amount payable for interest and penalties on income taxes is determined to be within the scope of Ind AS 37, it is presented as part of financing cost or other expenses, respectively unless when there is an overall settlement with tax authority and the interest and penalties cannot be identified separately in which case it is determined to be part of income taxes and accounted under Ind AS 12 Income Taxes.

See Note 9 - Income Taxes for further details.

## Y. Revenue Recognition

The Group derives revenue principally from sale of hydrate, speciality alumina, aluminium and aluminium value added products, di-ammonium phosphate, copper, precious metals (gold & silver) and other materials.

The Group recognizes revenue when it satisfies a performance obligation in accordance with the contract with the customer. This is achieved when control of the product has been transferred to the customer, which is generally determined when legal title, physical possession, risk of obsolescence, loss and rewards of ownership pass to the customer and the Group has the present right to payment, all of which occurs at a point in time upon shipment or delivery of the product. The Group considers shipping and handling activities as costs to fulfil the promise to transfer the related products and the customer payments for shipping and handling costs are recorded as a component of revenue.

In situations where revenue is recognized on shipment of goods, shipping and handling services are treated as a distinct separate performance obligation and the Group recognises revenue for such services when the performance obligation is completed.

The Group considers the terms of the contract in determining the transaction price. The transaction price is based upon the amount the Group expects to be entitled to in exchange for transferring of promised goods and services to the customer after deducting incentive programs, including but not limited to discounts, volume rebates etc. Transaction price excludes taxes and duties collected on behalf of the government.

For incentives offered to customers, the Group makes estimates related to customer performance and sales volume to determine the total amounts earned and to be recorded as deductions from "Revenue from contracts with customers". In making these estimates, the Group considers historical results that have a predictive value

of the amount that the Group expects to be entitled to for the transferred goods and services. If historical results have limited predictive value or the Group has limited experience with similar types of incentives, the estimate is made in such a manner, which ensures that it is highly probable that a significant reversal in the amount of cumulative revenue recognised will not occur. The actual amounts may differ from these estimates and are accounted for prospectively. No element of significant financing is deemed present as the sales are made with a credit term, which is consistent with market practice. The Group's obligation to repair or replace faulty products under the standard warranty terms is recognised as a cost with a corresponding provision.

For certain customer contracts, final prices are determined based on the underlying market index of commodity prices at a future date, for example prices on the London Metal Exchange Limited (LME) or London Bullion Markets Association (LBMA). In such contracts, the Group records revenue on a provisional basis considering current market price when control is transferred to the customer. At the end of each period, prior to final settlement date, adjustments are made to the provisional sale price based on movements in the underlying market index of commodity prices up to the date of final price determination. Such variable price movement is accounted as other operating revenue.

Revenue from irrevocable bill and hold/ holding certificate contracts is recognised when it is probable that delivery will be made, goods have been identified and kept separately, are ready for delivery in the present condition and usual payment terms for such contracts applies. Under these arrangements, revenue is recognised once legal title has passed and all significant risks and rewards of ownership of the asset sold are transferred to the customer.

Export incentives and subsidies are recognized when there is reasonable assurance that the Group will comply with the conditions and the incentive will be received.

Claim on insurance companies, railway authorities and others are accounted for on acceptance basis.

Revenue excludes any taxes and duties collected on behalf of the government.

See Note 25 - Revenue from Operations for further details.

## Z. Contract Liability

Contract liability is recognised when a payment for customer is already received before a related performance obligation is satisfied. If a customer pays consideration before the Group transfers goods or services to the customer, a contract liability is recognised when the payment is received.

# Notes

forming part of the Consolidated Financial Statements

As these are contracts that the Group expects, and has the ability, to fulfil through delivery of a non-financial item, these are presented as advance from customers and are recognised as revenue as and when control of respective commodities is transferred or service is provided to the customers under the agreements. The portion of the advance where either the Group does not have a unilateral right to defer settlement beyond twelve months or expects settlement within twelve months from the balance sheet date is classified as a current liability.

See Note 24 - Contract Liabilities for further details.

## AA. Dividend and Interest Income

Dividend income from investments is recognised when the Group's right to receive payment has been established.

Interest income from a financial asset is recognised when it is probable that the economic benefits will flow to the Group and the amount of income can be measured reliably. Interest income is accrued on a time basis, by reference to the principal outstanding and at the effective interest rate applicable, which is the rate that exactly discounts estimated future cash receipts through the expected life of the financial asset to that asset's net carrying amount on initial recognition.

See Note 26 - Other Income for further details.

## AB. Segment Reporting

An operating segment is a component of the Group that engages in business activities from which it may earn revenues and incur expenses, whose operating results are regularly reviewed by the Group's Chief Operating Decision Maker ("CODM") to make decisions for which discrete financial information is available. The Group prepares its segment information in conformity with the accounting policies adopted for preparing and presenting the financial statements of the Group as a whole. The CODM assesses the financial performance and position of the Group and makes strategic decisions. Operating segments are reported in a Manner consistent with the internal reporting provided to the CODM.

Allocation of common costs:

Common allocable costs are allocated to each segment according to the relative contribution of each segment to the total common costs.

Inter-segment transfers:

Inter-segment revenue has been accounted for based on the transaction price agreed to between segments which is based on current market prices.

Unallocated items:

Revenue, expenses, assets and liabilities which relate to the Group as a whole and not allocable to segments on reasonable basis have been included under 'unallocated revenue / expenses / assets / liabilities'.

See Note 40 - Segment Information for further details.

## AC. Exceptional Items

Exceptional items include income or expense that are considered to be part of ordinary activities, however are of such significance and nature that separate disclosure enables the user of the financial statements to understand the impact in a more meaningful manner. Exceptional items are identified by virtue of their size, nature and incidence.

See Note 37 - Exceptional Income/ (Expenses) (Net) for further details.

## 1C. Measurement of fair value

### a. Financial Instruments

The estimated fair value of the Group's financial instruments is based on market prices and valuation techniques. Valuations are made with the objective to include relevant factors that market participants would consider in setting a price, and to apply accepted economic and financial methodologies for the pricing of financial instruments. References for less active markets are carefully reviewed to establish relevant and comparable data.

### b. Marketable and non-marketable Equity Securities

Fair value for listed shares is based on quoted market prices as of the reporting date. Fair value for unlisted shares is calculated based on commonly accepted valuation techniques utilizing significant unobservable data, primarily cash flow based models.

### c. Derivatives

Fair value of financial derivatives is estimated as the present value of future cash flows, calculated by reference to quoted price curves and exchange rates as of the balance sheet date. Options are valued using appropriate option pricing models and credit spreads are applied where deemed to be significant.

### d. Embedded Derivatives

Embedded derivatives that are separated from the host contract are valued by comparing the forward curve at contract inception to the forward curve as of the balance sheet date. Changes in the present value of the cash flows related to the embedded derivative are recognized in the Consolidated Balance Sheet and in the Consolidated Statement of Profit and Loss.

## 1D. Critical accounting judgment and key sources of estimation uncertainty

In preparing the financial statements in conformity with accounting principles generally accepted in

India, management is required to make estimates and assumptions that affect reported amounts of assets and liabilities and the disclosure of contingent liabilities as at the date of the financial statements and the amounts of revenue and expenses during the reported period. Actual results could differ from those estimates. Any revision to such estimates is recognised in the period in which the same is determined.

The following paragraphs explains areas that are considered more critical, involving a higher degree of judgment and complexity.

### (a) Joint Operation

The Group invest in certain consortiums which are accounted for as joint operation. A joint operation is a joint arrangement whereby the parties that have joint control of the arrangement have rights to the assets, and obligations for the liabilities, relating to the arrangement. Joint control is the contractually agreed sharing of control of an arrangement, which exists only when decisions about the relevant activities require unanimous consent of the parties sharing control. When a group entity undertakes its activities under joint operations, the Group as a joint operator recognizes assets, liabilities, income and expenses in relation to its interest in a joint operation. (refer Note 48 C)

### (b) Impairment of Goodwill

Goodwill represents the excess of the purchase price over the fair value of the identifiable net assets of acquired companies. Goodwill is not amortized; instead, it is tested for impairment at least annually. The recoverable amount is determined based on value in use or fair value less cost to sell calculations which require the use of assumptions as directly observable market prices are generally not exist for the Group's assets. However, fair value may be estimated based on recent transactions on comparable assets, internal models used by the Group for transactions involving the same type of assets or other relevant information. Calculation of value in use is a discounted cash flow calculation based on continued use of the assets in its present condition, excluding potential exploitation of improvement or expansion potential. (refer Note 4)

### (c) Impairment of Non-Current Assets

Ind AS 36 requires that the Group assesses conditions that could cause an asset or a Cash Generating Unit (CGU) to become impaired and to test recoverability of potentially impaired assets. These conditions include changes resulting from market and economic environment, including internal and external factors such as the Group's market capitalization, significant

changes in the Group's planned use of the assets or a significant adverse change in the expected prices, sales volumes or raw material cost. The identification of CGUs involves judgment, including assessment of where active markets exist, and the level of interdependency of cash inflows. CGU is usually the individual plant, unless the asset or asset group is an integral part of a value chain where no independent prices for the intermediate products exist, a group of plants is combined and managed to serve a common market, or where circumstances otherwise indicate significant interdependencies.

In accordance with Ind-AS 36, certain intangible assets are reviewed at least annually for impairment. If a loss in value is indicated, the recoverable amount is estimated as the higher of the CGU's fair value less cost to sell, or its value in use. Directly observable market prices rarely exist for the Group's assets, however, fair value may be estimated based on recent transactions on comparable assets, internal models used by the Group for transactions involving the same type of assets or other relevant information. Calculation of value in use is a discounted cash flow calculation based on continued use of the assets in its present condition, excluding potential exploitation of improvement or expansion potential.

Determination of the recoverable amount involves management estimates on highly uncertain matters, such as commodity prices and their impact on markets and prices for upgraded products, development in demand, inflation, operating expenses and tax and legal environment. The Group uses internal business plans, quoted market prices and the Group's best estimate of commodity prices, currency rates, discount rates and other relevant information. A detailed forecast is developed for a period of three to five years with projections thereafter.

### (d) Employee retirement plans

The Group provides both defined benefit employee retirement plans and defined contribution plans. Measurement of pension and other superannuation costs and obligations under such plans require numerous assumptions and estimates that can have a significant impact on the recognized costs and obligation, such as future salary level, discount rate, attrition rate and mortality.

The Group provides defined benefit plans to its employees. The discount rate is based on Government bond yield. Assumptions for salary increase in the remaining service period for active plan participants are based on expected salary increase in India. Changes in these assumptions can influence the net asset or liability for the plan as well as the pension cost. (refer Note 30B)



# Notes

forming part of the Consolidated Financial Statements

(e) **Environmental liabilities and Asset Retirement Obligation (ARO)**

Estimation of environmental liabilities and ARO require interpretation of scientific and legal data, in addition to assumptions about probability and future costs. (refer Note 22)

(f) **Taxes**

The Group calculates income tax expense based on reported income. Deferred income tax expense is calculated based on the differences between the carrying value of assets and liabilities for financial reporting purposes and their respective tax basis that are considered temporary in nature. Valuation of deferred tax assets is dependent on management's assessment of future recoverability of the deferred tax benefit. Expected recoverability may result from expected taxable income in the future, planned transactions or planned tax optimizing measures. Economic conditions may change and lead to a different conclusion regarding recoverability. (refer Note 9B and 9C). For judgements related to adoption of lower tax rate as per Section 115BBA of the Income tax Act, refer note 9B(iv).

(g) **Extension and termination option in a Lease**

Extension and termination options are included in many of the leases. In determining the lease term the Management considers all facts and circumstances that create an economic incentive to exercise an extension option, or not exercise a termination option. This assessment is reviewed if a significant event or a significant change in circumstances occurs which affects this assessment and that is within the control of the Group.

(h) **Useful lives of depreciable/ amortisable assets (tangible and intangible)**

Management reviews its estimate of the useful lives of depreciable/ amortisable assets at each reporting date, based on the expected utility of the assets. Uncertainties in these estimates relate to technical and economic obsolescence that may change the utility of certain software, IT equipment and other plant and equipment.

(i) **Recoverability of advances/ receivables**

At each balance sheet date, based on discussions with the respective counter-parties and internal assessment of their credit worthiness, the management assesses the recoverability of outstanding receivables and advances. Such assessment requires significant management judgement based on financial position of the counter-parties, market information and other relevant factors.

(j) **Fair Value Measurements**

The Group applies valuation techniques to determine the fair value of financial instruments (where active market quotes are not available) and non-financial assets. This involves developing estimates and assumptions consistent with the market participants to price the instrument. The Group's assumptions are based on observable data as far as possible, otherwise on the best information available. Estimated fair values may vary from the actual prices that would be achieved in an arm's length transaction at the reporting date. (refer Note 45)

(k) **Contingent Assets and Liabilities, Provisions and Uncertain Tax Positions**

There are various legal, direct and indirect tax matters and other obligations including environmental, mining, local and state levies, income tax holiday, availing input tax credits etc., which may impact the Group. Evaluation of uncertain liabilities and contingent liabilities and assets arising out of above matters require management judgment and assumptions, regarding the probability of outflow or realization of economic resources and the timing and amount, or range of amounts, that may ultimately be determined. Such estimates may vary from the ultimate outcome as a result of differing interpretations of laws and facts, or application of relevant judicial precedents. (refer Note 9C, 22 and 43)

(l) **Inventory Measurement**

Measurement of bulk inventory quantities (such as coal, bauxite, copper concentrates, etc.) lying at yards and work in progress of precious metals at smelter and refinery is material, complex and involves significant judgement and estimate resulting from measuring the surface area, dip measurement of materials in tanks/silos, etc.

The Group performs physical counts of above inventory on a periodic basis using internal / external experts to perform volumetric surveys and assessments, basis which the estimate of quantity for these inventories is determined. The variations noted between book records and physical quantities of above inventories are evaluated and appropriately accounted in the books of accounts. (refer Note 11)

**1E. Recent Accounting Pronouncements**

(i) **New and amended standards adopted by the Group**

The Group has applied the following amendments to Ind AS for the first time for their annual reporting period commencing April 1, 2021:

- a) On March 24, 2021, the Ministry of Corporate Affairs ("MCA") through a notification, amended Schedule III of the Companies Act, 2013. The amendments revise Division I, II and III of Schedule III and are applicable from April 1, 2021. Key amendments relating to Division II which relate to companies whose financial statements are required to comply with Companies (Indian Accounting Standards) Rules 2015 are:

**Consolidated Balance Sheet:**

- Lease liabilities should be separately disclosed under the head 'financial liabilities', duly distinguished as current or non-current.
- Certain additional disclosures in the statement of changes in equity such as changes in equity share capital due to prior period errors and restated balances at the beginning of the current reporting period.
- Specified format for disclosure of shareholding of promoters.
- Specified format for ageing schedule of trade receivables, trade payables, capital work-in-progress and intangible asset under development.
- If a company has not used funds for the specific purpose for which it was borrowed from banks and financial institutions, then disclosure of details of where it has been used.
- Specific disclosure under 'additional regulatory requirement' such as compliance with approved schemes of arrangements, compliance with number of layers of companies, title deeds of immovable property not held in name of company, loans and advances to promoters, directors, key managerial personnel (KMP) and related parties, details of benami property held, certain specified ratios etc.

**Consolidated Statement of profit and loss:**

- Additional disclosures relating to Corporate Social Responsibility (CSR), undisclosed income and crypto or virtual currency specified under the head 'additional information' in the notes forming part of the consolidated financial statements.
- b) Extension of COVID-19 related concessions – amendments to Ind AS 116
- c) Interest rate benchmark reform – amendments to Ind AS 109, Financial Instruments, Ind AS 107, Financial Instruments: Disclosures, Ind AS 104, Insurance Contracts and Ind AS 116, Leases.

The amendments listed above did not have any impact on the amounts recognised in prior periods and are not expected to significantly affect the current or future periods.

(ii) **Amended applicable from next Financial year**

Ministry of Corporate Affairs ("MCA") notifies new standards or amendments to the existing standards under Companies (Indian Accounting Standards) Rules as issued from time to time. On March 23, 2022, MCA amended the Companies (Indian Accounting Standards) Amendment Rules, 2022, as below.

• **Ind AS 16–Property Plant and equipment**

The amendment clarifies that excess of net sale proceed so items produced over the cost of testing, if any, shall not be recognised in the profit or loss but deducted from the directly attributable costs considered as part of cost of an item of property, plant, and equipment. The effective date for adoption of this amendment is annual periods beginning on or after April 1, 2022. The Company has evaluated the amendment and there is no impact on its consolidated financial statements.

• **Ind AS 37 – Provisions, Contingent Liabilities and Contingent Assets**

The amendment specifies that the 'cost of fulfilling' a contract comprises the 'costs that relate directly to the contract'. Costs that relate directly to a contract can either be incremental costs of fulfilling that contract (examples would be direct labour, materials) or an allocation of other costs that relate directly to fulfilling contracts (an example would be the allocation of the depreciation charge for an item of property, plant and equipment used in fulfilling the contract).

Onerous Contracts (Cost of Fulfilling a Contract) - An entity shall apply those amendments to contracts for which it has not yet fulfilled all its obligations at the beginning of the annual reporting period in which it first applies the amendments. The entity shall not restate comparative information. Instead, the entity shall recognise the cumulative effect of initially applying the amendments as an adjustment to the opening balance of retained earnings or other component of equity, as appropriate, at the date of initial application.

The effective date for adoption of this amendment is annual periods beginning on or after April 1, 2022, although early adoption is permitted.

The Group has evaluated the amendment and the impact is not expected to be material.

# Notes

forming part of the Consolidated Financial Statements

## 2. Property, Plant and Equipment (including Right of Use Assets) and Capital Work-in-Progress

Refer Note 1B(D) for accounting policy on Property, Plant and Equipment

Refer Note 1B(J) for accounting policy on Impairment of Non-Current Assets (excluding Goodwill)

Refer Note 1B(M) for accounting policy on Leases

Refer Note 1B(T) for accounting policy on Borrowing cost

**Summary of Property, Plant and Equipment (including Right of Use Assets) given below:**

	As at	
	31/03/2022	31/03/2021
Property, Plant and Equipment - Cost	128,752	118,169
Less: Accumulated Depreciation and Impairment	(54,205)	(49,235)
<b>Net carrying amount of Property, Plant and Equipment - (A)</b>	<b>74,547</b>	<b>68,934</b>
Right of Use Assets - Cost	2,767	2,524
Less: Accumulated Depreciation and Impairment	(844)	(609)
<b>Net carrying amount of Right of Use Assets - (B)</b>	<b>1,923</b>	<b>1,915</b>
<b>Property, Plant and Equipment (including Right of Use Assets) - (A + B)</b>	<b>76,470</b>	<b>70,849</b>
<b>Capital Work-in-Progress (CWIP)</b>	<b>4,727</b>	<b>10,013</b>

### A. Property, Plant and Equipment

Particulars	ORIGINAL COST					ACCUMULATED DEPRECIATION AND IMPAIRMENT					NET CARRYING AMOUNT			
	As at April 01, 2021	Additions	Additions due to acquisition*	Disposal/ Adjustments	Exchange differences	As at March 31, 2022	As at April 01, 2021	Depreciation	Impairment/ (Reversal)	Disposal/ Adjustments	Exchange differences	As at March 31, 2022	As at March 31, 2022	As at March 31, 2021
Freehold Land	3,138	132	42	(64)	5	3,253	167	4	-	-	6	177	3,076	2,971
Leasehold Improvements	432	37	-	-	12	481	200	33	-	-	7	240	241	232
Buildings	22,419	2,401	116	(226)	371	25,081	7,929	875	14	(172)	100	8,746	16,335	14,490
Plant and Machinery	88,002	7,318	252	(953)	889	95,508	38,428	4,290	63	(802)	368	42,347	53,161	49,574
Vehicles and Aircraft	724	93	1	(64)	8	762	445	57	-	(42)	5	465	297	279
Railway Wagons	336	20	-	-	-	356	159	20	-	-	-	179	177	177
Railway Sidings	752	21	-	-	-	773	322	43	-	-	-	365	408	430
Furniture and Fixtures	1,345	128	2	(81)	(5)	1,389	927	89	-	(75)	(9)	932	457	418
Office Equipment	1,021	134	3	(22)	13	1,149	658	104	-	(20)	12	754	395	363
<b>Total</b>	<b>118,169</b>	<b>10,284</b>	<b>416</b>	<b>(1,410)</b>	<b>1,293</b>	<b>128,752</b>	<b>49,235</b>	<b>5,515</b>	<b>77</b>	<b>(1,111)</b>	<b>489</b>	<b>54,205</b>	<b>74,547</b>	<b>68,934</b>

Particulars	ORIGINAL COST					ACCUMULATED DEPRECIATION AND IMPAIRMENT					NET CARRYING AMOUNT			
	As at April 01, 2020	Additions	Additions due to acquisition	Disposal/ Adjustments	Exchange differences	As at March 31, 2021	As at April 01, 2020	Depreciation	Impairment/ (Reversal)	Disposal/ Adjustments	Exchange differences	As at March 31, 2021	As at March 31, 2021	As at March 31, 2020
Freehold Land	2,738	72	276	7	45	3,138	164	4	-	3	(4)	167	2,971	2,574
Leasehold Improvements	430	3	9	(1)	(9)	432	176	27	-	(1)	(2)	200	232	254
Buildings	20,241	459	1,758	11	(50)	22,419	7,023	902	23	(6)	(13)	7,929	14,490	13,218
Plant and Machinery	82,034	2,306	4,621	(1,003)	44	88,002	35,050	4,172	48	(831)	(11)	38,428	49,574	46,984
Vehicles and Aircraft	721	35	1	(30)	(3)	724	415	56	-	(25)	(1)	445	279	306
Railway Wagons	336	-	-	-	-	336	140	19	-	-	-	159	177	196
Railway Sidings	490	7	-	255	-	752	193	28	-	101	-	322	430	297
Furniture and Fixtures	1,221	162	4	(67)	25	1,345	883	88	-	(67)	23	927	418	338
Office Equipment	727	126	206	(57)	19	1,021	585	110	-	(47)	10	658	363	142
<b>Total</b>	<b>108,938</b>	<b>3,170</b>	<b>6,875</b>	<b>(885)</b>	<b>71</b>	<b>118,169</b>	<b>44,629</b>	<b>5,406</b>	<b>71</b>	<b>(873)</b>	<b>2</b>	<b>49,235</b>	<b>68,934</b>	<b>64,309</b>

\* Refer Note 49 - Business Combination

(a) Group's share in jointly owned assets has been grouped together with the relevant class of property, plant and equipment and Capital Work-in-Progress. The cost and net carrying amounts included in relevant class of assets are given below:

Particulars	31/03/2022		31/03/2021	
	Original Cost	Net Carrying Amount	Original Cost	Net Carrying Amount
Freehold Land	52	52	52	52
Buildings	54	40	50	37
Plant and Machinery	6	1	41	2
Furniture and Fixtures	27	22	14	10
Office Equipment	9	2	9	2
Capital Work-in-Progress	101	101	104	104

(b) For assets pledged and Hypothecated against borrowings, refer Note 18A.

(c) For impairment charge/(reversal), refer Note 34.

(d) For capital expenditures contracted but not incurred, refer to Note 43 (B).

(e) CWIP comprise of various routine, non-routine projects and expansion spread over across the Group.



# Notes

forming part of the Consolidated Financial Statements

(f) CWIP ageing schedule as at 31/03/2022:

(₹ in Crore)

Particulars	Amount in CWIP for a period of				Total
	Less than 1 year	1-2 years	2-3 years	More than 3 years	
Projects in progress	2,133	1,845	430	118	4,526
Projects temporarily suspended	1	2	21	177	201
<b>Total</b>	<b>2,134</b>	<b>1,847</b>	<b>451</b>	<b>295</b>	<b>4,727</b>

CWIP ageing schedule as at 31/03/2021:

(₹ in Crore)

Particulars	Amount in CWIP for a period of				Total
	Less than 1 year	1-2 years	2-3 years	More than 3 years	
Projects in progress	3,298	3,396	434	2,730	9,858
Projects temporarily suspended	4	13	22	116	155
<b>Total</b>	<b>3,302</b>	<b>3,409</b>	<b>456</b>	<b>2,846</b>	<b>10,013</b>

(g) CWIP completion schedule for projects, whose completion is overdue or has exceeded its cost compared to its original plan as at 31/03/2022 are given below:

(₹ in Crore)

Projects	To be completed in				Total
	Less than 1 year	1-2 years	2-3 years	More than 3 years	
<b>(i) Project in Progress</b>					
Brazil plant expansion <sup>#</sup>	1,115	-	-	-	1,115
China plate expansion <sup>#</sup>	93	-	-	-	93
China cast house <sup>#</sup>	-	-	163	-	163
Installation of Desulphurization System at Hirakud Power plant <sup>#</sup>	22	-	-	-	22
Electro Static Precipitators for boilers of Renusagar Power plant <sup>#</sup>	18	-	-	-	18
Other projects <sup>5,#</sup>	76	-	-	-	76
<b>(ii) Project temporarily suspended</b>					
Slow cooled converter slag and part Flash Smelting Furnace slag at Dahej plant <sup>#</sup>	-	69	-	-	69
Construction of New Office Building, Mumbai <sup>#</sup>	-	-	-	73	73
<b>Total</b>	<b>1,324</b>	<b>-</b>	<b>163</b>	<b>-</b>	<b>1,487</b>

CWIP completion schedule for projects, whose completion is overdue or has exceeded its cost compared to its original plan as at 31/03/2021 are given below:

(₹ in Crore)

Projects	To be completed in				Total
	Less than 1 year	1-2 years	2-3 years	More than 3 years	
<b>(i) Project in Progress</b>					
Utkal - Brownfield Project *	1,587	-	-	-	1,587
Track Hopper at Coal Handling at Aditya plant <sup>#</sup>	-	56	-	-	56
Suspended Particulate Matter (SPM) reduction at 6 units of Electro Static Precipitators at Aditya plant <sup>#</sup>	-	18	-	-	18
Degreasing and Circle Blanking Line at Renukoot Rolled Plant <sup>#</sup>	-	82	-	-	82
New 6" Extrusion Press at Renukoot Extrusion Plant <sup>#</sup>	-	47	-	-	47
Electro Static Precipitators for boilers of Renusagar Power Plant <sup>#</sup>	-	21	-	-	21
Tertiary Water Recycling Unit at Dahej plant <sup>#</sup>	-	50	-	-	50
Aditya Birla Centre <sup>#</sup>	20	-	-	-	20
Other projects <sup>5,#</sup>	25	78	-	-	103
Slow Cooled Converter Slag And Part Fsf Slag Of 500 TPD <sup>#</sup>	-	-	68	-	68
<b>(ii) Project temporarily suspended</b>					
Construction of New Office Building, Mumbai <sup>#</sup>	-	-	-	73	73
<b>Total</b>	<b>1,632</b>	<b>352</b>	<b>68</b>	<b>73</b>	<b>2,125</b>

<sup>5</sup> It represents the projects having budgeted capital expenditure amount below ₹ 10 crore.

\* represents project with cost overrun

# represents delayed project

(h) The Group has tested the carrying value of CWIP for impairment as at reporting date and recorded an impairment charge of ₹ 19 crore (31/03/2021 ₹ 5 crore). refer Note 34.

(i) Useful life of items of Property, Plant and Equipment is given below:

Items of Property, Plant and Equipment	Useful life (Years)
Freehold Land	Infinite <sup>5</sup>
Leasehold Improvements	7 - 90
Buildings	3 - 60
Plant and Machinery	2 - 40
Vehicles and Aircraft	2 - 25
Railway Wagons	15
Railway Sidings	15
Furniture and Fixtures	3 - 10
Office Equipment	2 - 25

<sup>5</sup>Freehold land used for mining is depreciated over 8 - 30 years.

(j) The Property, Plant and Equipment residual values and useful lives are reviewed, and adjusted if appropriate, at the end of each reporting period.

# Notes

forming part of the Consolidated Financial Statements

## B. Right of Use Assets

The Group leases many assets including Land, Buildings, Stadium Suite, Plant and Machinery, Vehicles, Aircraft, Boats, Railway wagons, Railway sidings and furniture. These right of use assets are presented as part of 'Property, plant and equipment' under non-current assets on the face of the consolidated balance sheet.

Particulars	ORIGINAL COST					ACCUMULATED DEPRECIATION AND IMPAIRMENT					NET CARRYING AMOUNT			
	As at April 01, 2021	Additions	Additions due to acquisition	Disposal/ Adjustments	Exchange differences	As at March 31, 2022	As at April 01, 2021	Depreciation	Impairment/ (Reversal)	Disposal/ Adjustments	Exchange differences	As at March 31, 2022	As at March 31, 2021	
	Leasehold Land	1,146	57	-	(40)	18	1,181	74	46	-	(22)	2	100	1,081
Buildings	535	112	-	(22)	17	642	165	109	-	(20)	8	262	380	370
Stadium Suite	41	-	-	-	2	43	9	4	-	-	(1)	12	31	32
Plant and Machinery	208	63	-	(69)	2	204	115	37	-	(45)	7	114	90	93
Vehicles and Aircraft	279	174	-	(30)	(2)	421	107	95	-	(9)	(2)	191	230	172
Boats	59	-	-	-	-	59	22	12	-	-	-	34	25	37
Railway Wagons	176	1	-	(39)	(3)	135	74	24	-	(25)	-	73	62	102
Railway Sidings	2	-	-	-	-	2	-	-	-	-	-	-	2	2
Waterfront	1	-	-	-	-	1	-	-	-	-	-	-	1	1
Furniture and Fixtures	36	-	-	(3)	-	33	22	7	-	(3)	-	26	7	14
Office Equipment	41	5	-	(2)	2	46	21	11	-	(1)	1	32	14	20
<b>Total</b>	<b>2,524</b>	<b>412</b>	<b>-</b>	<b>(205)</b>	<b>36</b>	<b>2,767</b>	<b>609</b>	<b>345</b>	<b>-</b>	<b>(125)</b>	<b>15</b>	<b>844</b>	<b>1,923</b>	<b>1,915</b>

Particulars	ORIGINAL COST					ACCUMULATED DEPRECIATION AND IMPAIRMENT					NET CARRYING AMOUNT			
	As at April 01, 2020	Additions	Additions due to acquisition	Disposal/ Adjustments	Exchange differences	As at March 31, 2021	As at April 01, 2020	Depreciation	Impairment/ (Reversal)	Disposal/ Adjustments	Exchange differences	As at March 31, 2021	As at March 31, 2020	
	Leasehold Land	1,031	5	98	6	6	1,146	28	39	-	6	1	74	1,072
Buildings	425	227	69	(174)	(12)	535	80	129	-	(42)	(2)	165	370	345
Stadium Suite	21	21	-	-	(1)	41	3	2	-	4	-	9	32	18
Plant and Machinery	132	37	43	(13)	9	208	90	30	-	(5)	-	115	93	42
Vehicles and Aircraft	197	131	10	(62)	3	279	69	87	-	(50)	1	107	172	128
Boats	59	-	-	-	-	59	10	12	-	-	-	22	37	49
Railway Wagons	171	-	-	-	5	176	35	38	-	-	1	74	102	136
Railway Sidings	21	-	-	(19)	-	2	9	-	-	(9)	-	-	2	12
Waterfront	1	-	-	-	-	1	-	-	-	-	-	-	1	1
Furniture and Fixtures	42	-	-	(7)	1	36	22	7	-	(7)	-	22	14	20
Office Equipment	9	30	7	(4)	(1)	41	5	18	-	(2)	-	21	20	4
<b>Total</b>	<b>2,109</b>	<b>451</b>	<b>227</b>	<b>(273)</b>	<b>10</b>	<b>2,524</b>	<b>351</b>	<b>362</b>	<b>-</b>	<b>(105)</b>	<b>1</b>	<b>609</b>	<b>1,915</b>	<b>1,758</b>

(a) Disposal/ Adjustments for the lease hold land includes ₹ 21 crore (31/03/2021: ₹ 35 crore) transferred from right of use assets to mining rights under intangible assets, refer Note 5.

## C. Lease Liabilities recognised against Right of Use Assets are as follows:

	As at			
	31/03/2022		31/03/2021	
	Non-Current	Current	Non-Current	Current
Lease Liabilities against Right of Use Assets	972	279	928	300
	<b>972</b>	<b>279</b>	<b>928</b>	<b>300</b>

## 3. Investment Property

Refer Note 1B(E) for accounting policy on Investment Property

Refer Note 1B(J) for accounting policy on Impairment of Non-Current Assets (excluding Goodwill)

	As at	
	31/03/2022	31/03/2021
Cost	34	34
Less: Accumulated Depreciation and Impairment	(13)	(13)
<b>Net Carrying amount</b>	<b>21</b>	<b>21</b>

Particulars	ORIGINAL COST					ACCUMULATED DEPRECIATION AND IMPAIRMENT					NET CARRYING AMOUNT		
	As at April 01, 2021	Additions	Disposal/ Adjustments	Exchange differences	As at March 31, 2022	As at April 01, 2021	Depreciation	Impairment/ (Reversal)	Disposal/ Adjustments	Exchange differences	As at March 31, 2022	As at March 31, 2021	
	Freehold Land	1	-	-	-	1	-	-	-	-	-	-	1
Buildings	33	-	1	-	34	13	1	-	-	-	14	20	20
<b>Total</b>	<b>34</b>	<b>-</b>	<b>1</b>	<b>-</b>	<b>35</b>	<b>13</b>	<b>1</b>	<b>-</b>	<b>-</b>	<b>-</b>	<b>14</b>	<b>21</b>	<b>21</b>

Particulars	ORIGINAL COST					ACCUMULATED DEPRECIATION AND IMPAIRMENT					NET CARRYING AMOUNT		
	As at April 01, 2020	Additions	Disposal/ Adjustments	Exchange differences	As at March 31, 2021	As at April 01, 2020	Depreciation	Impairment/ (Reversal)	Disposal/ Adjustments	Exchange differences	As at March 31, 2021	As at March 31, 2020	
	Freehold Land	1	-	-	-	1	-	-	-	-	-	-	1
Buildings	33	-	-	-	33	12	1	-	-	-	13	20	21
<b>Total</b>	<b>34</b>	<b>-</b>	<b>-</b>	<b>-</b>	<b>34</b>	<b>12</b>	<b>1</b>	<b>-</b>	<b>-</b>	<b>-</b>	<b>13</b>	<b>21</b>	<b>22</b>

(a) Amount recognised in profit and loss for Investment Properties are as under:

	Year ended	
	31/03/2022	31/03/2021
Rental Income	6	6
Direct operating expenses (including repair and maintenance) on properties generating rental income	-	(1)



# Notes

forming part of the Consolidated Financial Statements

- (b) The Group has no contractual obligations to purchase, construct or develop investment properties or for repairs, maintenance and enhancements. There are no restrictions on the realisability of investment properties or the remittance of income and proceeds of disposal on the Group.
- (c) The fair value of the Group's investment properties as at 31/03/2022 and 31/03/2021 have been arrived on the basis of valuation carried out at the respective dates by an external, independent valuer. Independent valuer who arrived at fair value as at 31/03/2022 is registered under Rule 2 of the Companies (Registered Valuers and Valuation) Rules, 2017. However values as at 31/03/2021 were done by an independent valuer who was not registered as per the above mentioned rule.
- (d) The fair value measurement for all the investments properties has been categorised as Level 2 fair value based on the inputs to the valuation technique used. Considering the type of the assets, market approach (sales comparable method) to estimate the fair value of the subject properties is adopted.

Fair value of investment properties and their fair value hierarchy given below:

	As at	
	31/03/2022	31/03/2021
	Level 2	Level 2
Freehold land	4	3
Buildings	100	96

- (e) Useful life of items of Investment Property is given below:

Items of Investment Property	Useful life (Years)
Freehold Land	Infinite
Buildings	60 Years

- (f) Certain Investment Properties are given as security towards Non-Convertible debentures of ₹ 6,000 crore (gross) (31/03/2021: ₹ 6,000 crore), refer Note 18A (a).

## 4. Goodwill

Refer Note 1B(i) for accounting policy on Goodwill

	As at	
	31/03/2022	31/03/2021
	Cost	23,965
Less: Accumulated Impairment	-	-
<b>Net Carrying amount</b>	<b>23,965</b>	<b>23,317</b>

	Cost	Accumulated Impairment	Net carrying amount
<b>Balance as at April 01, 2020</b>	20,098	-	20,098
Addition through business combination	3,562	-	3,562
Exchange differences	(343)	-	(343)
<b>Balance as at March 31, 2021</b>	<b>23,317</b>	<b>-</b>	<b>23,317</b>
Addition through business combination - (refer Note 49)	67	-	67
Exchange differences	581	-	581
<b>Balance as at March 31, 2022</b>	<b>23,965</b>	<b>-</b>	<b>23,965</b>

- (a) **Impairment testing of Goodwill**

Goodwill acquired in business combinations has been allocated to following cash generating units (CGU) of Novelis, Aluminium and Copper segment.

	As at	
	31/03/2022	31/03/2021
	<b>Novelis segment</b>	
Novelis - North America	10,949	10,549
Novelis - Europe	8,281	8,237
Novelis - South America	2,778	2,677
Novelis - Asia	1,780	1,744
<b>Aluminium segment</b>		
Utkal Alumina International Limited (Utkal)	110	110
Minerals and Minerals Limited (M&M)	*	*
Kuppam - (refer Note 49)	4	-
<b>Copper segment</b>		
Birla Copper Asoj Private Limited - (refer Note 49)	63	-
	<b>23,965</b>	<b>23,317</b>

\* it represents Goodwill on acquisition of M&M ₹ 0.12 crore.

Goodwill is not amortized, instead, it is tested for impairment annually or more frequently if indicators of impairment exist. The recoverable amount of a cash generating unit (CGU) is determined based on value-in-use or fair value less cost to sell calculations which require the use of certain assumptions. The calculations use cash flow projections based on financial budgets approved by management covering three to five years period depending upon segment/ CGU's financial budgeting process. Cash flow beyond these financial budget period are extrapolated using the estimated growth rates.

The key assumptions used in the estimation of the recoverable amount of CGU's are set out below. The values assigned to the key assumptions represent management's assessment of future trends in the relevant industries and economic environment and have been based on historical data from both external and internal sources.

	Novelis segment		Aluminium segment		Copper segment	
	31/03/2022	31/03/2021	31/03/2022	31/03/2021	31/03/2022	31/03/2021
Discount rate (i)	8.93%	8.82%	13.20%	13.20%	12.00%	NA
Terminal growth rate (ii)	2.25%	2.25%	4.50%	4.50%	2.00%	NA
EV/EBITDA multiple in times (in Novelis segment)	5.5 to 10.5	7 to 13.5	-	-	-	NA

- i. **For Novelis segment**, the estimate of fair value (Level 3) less cost to sell for each cash generating unit is based on average of discounted cash flows (the income approach) and guideline public company method which considers enterprise Value ("EV")/EBITDA multiples of comparable companies adjusted with control premium (the market approach).

Under the income approach, the fair value of each cash generating unit is based on the present value of estimated future cash flows. The income approach is dependent on a number of significant management assumptions including markets and market share, sales volumes and prices, costs to produce, capital spending, working capital changes and the discount rate. These projected cash flows are discounted to the present value using a weighted average cost of capital (discount rate). The discount rate is commensurate with the risk inherent in the projected cash flows and reflects the rate of return required by an investor in the current economic conditions. The projections are based

# Notes

forming part of the Consolidated Financial Statements

on both past performance and the expectations of future performance and assumptions used in Novelis's current operating plan.

The Group uses the trailing and forward EV/EBITDA multiples. EV is defined as the total of equity capital plus debt capital. The trailing multiples have been based on the EBITDA of the trailing twelve months preceding the valuation date and the forward multiples have been based on the one-year and two-year forward consensus analyst EBITDA estimates as on the valuation date and has been adjusted for control premium.

**For Aluminium and Copper segment**, the recoverable amount is determined based on value in use and the projected cash flows are discounted to the present value using pre-tax weighted average cost of capital (discount rate). The discount rate commensurate with the risk inherent in the projected cash flows and reflects the rate of return required by an investor in the current economic conditions.

The Group assessed the impact of change in key assumption related to Aluminium and Copper segments and did not notice any material change in its recoverable value and thereby has concluded that the change will not cause recoverable value fall below its carrying value.

- ii. The Group use's specific revenue growth assumptions for each cash generating unit based on history and economic conditions.

As a result of goodwill impairment test for the year ended 31/03/2022 and year ended 31/03/2021, no goodwill impairment was identified as the recoverable value of the CGUs to whom goodwill was allocated exceeded their respective carrying amounts at all the periods reported above.

## (b) Impact of possible changes in key assumptions

Goodwill in the Consolidated Financial Statements primarily consists of goodwill in Novelis segment, wherein goodwill has been allocated in four CGUs. The recoverable amount of each of these four CGUs would equal its carrying amount if the key assumptions were to change as follows:

	As at			
	31/03/2022		31/03/2021	
	From	To	From	To
<b>i. Long-term growth rate (%)</b>				
Novelis - North America	2.25%	**	2.25%	**
Novelis - Europe	2.25%	**	2.25%	**
Novelis - South America	2.25%	**	2.25%	**
Novelis - Asia	2.25%	**	2.25%	**
<b>ii. Post-tax discount rate (%)</b>				
Novelis - North America	8.93%	**	8.82%	**
Novelis - Europe	8.93%	**	8.82%	**
Novelis - South America	8.93%	**	8.82%	**
Novelis - Asia	8.93%	**	8.82%	**
<b>iii. EV/EBITDA multiple (in times)</b>				
Novelis - North America	5.5 - 7.5	**	7 - 10.5	**
Novelis - Europe	7.5 - 10.5	**	8.5 - 13.5	**
Novelis - South America	7.5 - 10.5	**	7 - 10.5	**
Novelis - Asia	5.5 - 7.5	**	8.5 - 13.5	**

\*\* Management believes that no reasonably possible change in any of the above key assumptions would cause the recoverable amount to fall below the carrying value of any of the CGU having allocated goodwill.

## 5. Other Intangible Assets and Intangible Assets under Development

Refer Note 1B(F) for accounting policy on Intangible Assets (Other than goodwill)

Refer Note 1B(G) for accounting policy on Stripping cost

Refer Note 1B(J) for accounting policy on Impairment of Non-Current Assets (excluding Goodwill)

Refer Note 1B(T) for accounting policy on Borrowing cost

	As at	
	31/03/2022	31/03/2021
Cost	14,392	13,008
Less: Accumulated Amortisation and Impairment	(7,974)	(6,926)
<b>Net Carrying amount</b>	<b>6,418</b>	<b>6,082</b>
<b>Intangible Assets under Development (IAUD)</b>	<b>218</b>	<b>189</b>

Particulars	ORIGINAL COST						ACCUMULATED AMORTISATION AND IMPAIRMENT					NET CARRYING AMOUNT		
	As at April 01, 2021	Additions	Additions due to acquisition*	Disposal/ Adjustments	Exchange differences	As at March 31, 2022	As at April 01, 2021	Amor-ti-sation	Impair-ment/(Re-versal)	Disposal/ Adjust-ments	Exchange differences	As at March 31, 2022	As at March 31, 2022	As at March 31, 2021
Mining Rights	803	87	-	(27)	1	864	406	89	-	(37)	1	459	405	397
Trade Name	1,138	-	-	-	42	1,180	777	82	-	-	30	889	291	361
Technology and Software	4,295	300	9	(4)	103	4,703	3,332	406	-	(4)	110	3,844	859	963
Customer related Intangible Assets	6,275	4	15	-	205	6,499	2,411	295	-	-	76	2,782	3,717	3,864
Favourable Contracts	-	-	6	-	-	6	-	-	-	-	-	-	6	-
Carbon Emission Rights	497	833	-	(220)	30	1,140	-	-	-	-	-	-	1,140	497
<b>Total</b>	<b>13,008</b>	<b>1,224</b>	<b>30</b>	<b>(251)</b>	<b>381</b>	<b>14,392</b>	<b>6,926</b>	<b>872</b>	<b>-</b>	<b>(41)</b>	<b>217</b>	<b>7,974</b>	<b>6,418</b>	<b>6,082</b>

Particulars	ORIGINAL COST						ACCUMULATED AMORTISATION AND IMPAIRMENT					NET CARRYING AMOUNT		
	As at April 01, 2020	Additions	Additions due to acquisition	Disposal/ Adjustments	Exchange differences	As at March 31, 2021	As at April 01, 2020	Amor-ti-sation	Impair-ment/(Re-versal)	Disposal/ Adjust-ments	Exchange differences	As at March 31, 2021	As at March 31, 2021	As at March 31, 2020
Mining Rights	715	59	-	31	(2)	803	321	45	44	-	(4)	406	397	394
Trade Name	1,100	-	73	-	(35)	1,138	717	81	-	-	(21)	777	361	383
Technology and Software	3,747	123	401	-	24	4,295	2,953	449	-	-	(70)	3,332	963	794
Customer related Intangible Assets	3,358	-	3,066	-	(149)	6,275	2,156	291	-	-	(36)	2,411	3,864	1,202
Carbon Emission Rights	235	268	18	(13)	(11)	497	-	-	-	-	-	-	497	235
<b>Total</b>	<b>9,155</b>	<b>450</b>	<b>3,558</b>	<b>18</b>	<b>(173)</b>	<b>13,008</b>	<b>6,147</b>	<b>866</b>	<b>44</b>	<b>-</b>	<b>(131)</b>	<b>6,926</b>	<b>6,082</b>	<b>3,008</b>

\* Refer Note 49 - Business Combination



# Notes

forming part of the Consolidated Financial Statements

- (a) Addition in Mining Rights includes ₹ 57 crore (31/03/2021: ₹ 44 crore) and amortization expense includes ₹ 76 crore (31/03/2021: ₹ 20 crore) towards stripping activity assets.
- (b) The Carrying Amount of Intangible Asset under Development includes ₹ 8 crore (31/03/2021: ₹ 116 crore) pertaining to Enterprise Resource Planning System implementation in India. During the current year, the Company has capitalised its Enterprise Resource Planning System.
- (c) Carbon emission credits are recognised at fair value upon receipt of government grants for operations in Europe and Asia, which becomes their cost basis.
- (d) **Intangible asset under development (IAUD) ageing schedule as at 31/03/2022:**

(₹ in Crore)

Particulars	Amount in IAUD for a period of				Total
	Less than 1 year	1-2 years	2-3 years	More than 3 years	
Projects in progress	191	25	2	-	218
Projects temporarily suspended	-	-	-	-	-
<b>Total</b>	<b>191</b>	<b>25</b>	<b>2</b>	<b>-</b>	<b>218</b>

**Intangible asset under development (IAUD) ageing schedule as at 31/03/2021:**

(₹ in Crore)

Particulars	Amount in IAUD for a period of				Total
	Less than 1 year	1-2 years	2-3 years	More than 3 years	
Projects in progress	103	50	36	-	189
Projects temporarily suspended	-	-	-	-	-
<b>Total</b>	<b>103</b>	<b>50</b>	<b>36</b>	<b>-</b>	<b>189</b>

- (e) There are no projects, whose completion is overdue or has exceeded its cost compared to its original plan as at 31/03/2022. Completion schedule for projects, whose completion is overdue or has exceeded its cost compared to its original plan as at 31/03/2021 are given below:

(₹ in Crore)

Project name	Suspended Project Details (Yes/No)	To be completed in			
		Less than 1 year	1-2 years	2-3 years	More than 3 years
Enterprise Resource Planning System (Project Ekayaan) *	No	116	-	-	-
<b>Total</b>		<b>116</b>	<b>-</b>	<b>-</b>	<b>-</b>

\* Project is presented due to time overrun. There is no cost overrun in above project.

- (f) The Group has tested the carrying value of Intangible Asset under Development for impairment as at reporting dates and no impairment charge has been identified on the same.
- (g) For impairment charges or reversal on above Intangible assets, refer Note 34.
- (h) Useful life of items of Intangible Assets and their remaining useful lives are given below:

Items of Intangible Assets	Useful life (Years)	Remaining useful life (Years)
Trade Name	3 - 20	0 - 17
Technology and Software	3 - 10	0 - 8
Customer related Intangible Assets	20 - 22.3	20
Mining Rights	8 - 41	4 - 34
Favourable Contracts	3	3

- (i) For Guarantee, assets pledged and Hypothecated against borrowings, refer Note 18A.
- (j) The useful life of intangible assets are reviewed, and adjusted if appropriate, at the end of each reporting period.
- (k) All Computer Software items in Intangible Assets (except of Mahan Aluminium, Aditya Aluminium, Kalwa Plant of the Company) are also given as security towards Non-convertible debentures of ₹ 6,000 crore (as at 31/03/2021: ₹ 6,000 crore). Refer note - 18A (a).

## 6A. Investments, Non-Current (Fully paid-up unless otherwise stated)

Refer Note 1B(Q) for accounting policy on Financial Instruments

(₹ in Crore)

Equity Instruments at FVTOCI- (a)	Face value	Numbers as at		Value as at	
		31/03/2022	31/03/2021	31/03/2022	31/03/2021
<b>Quoted</b>	<b>per Unit</b>				
National Aluminium Company Limited	₹ 5	-	29,233,228	-	158
Grasim Industries Limited	₹ 2	28,464,653	28,464,653	4,736	4,129
Ultra Tech Cement Limited	₹ 10	1,258,515	1,258,515	831	848
Vodafone Idea Limited	₹ 10	751,119,164	751,119,164	725	695
Aditya Birla Fashion and Retail Limited	₹ 10	50,239,794	44,982,142	1,518	905
Aditya Birla Fashion and Retail Limited (Partly paid up) - (b)	₹ 7.50	-	5,257,652	-	89
Gujarat Narmada Valley Fertilizers & Chemicals Limited	₹ 10	100	100	-	-
Gujarat State Fertilizers & Chemicals Limited	₹ 2	500	500	-	-
Southern Petrochemical Industries Limited	₹ 10	100	100	-	-
Madras Fertilizer Limited	₹ 10	100	100	-	-
Rashtriya Chemicals and Fertilizers Limited	₹ 10	100	100	-	-
Aditya Birla Capital Limited	₹ 10	39,850,514	39,850,514	429	475
				<b>8,239</b>	<b>7,299</b>
<b>Unquoted</b>					
Sai Wardha Power Generation Limited	₹ 10	2,830,352	2,830,352	-	-
Birla International Limited	CHF 100	2,500	2,500	5	5
Bharuch-Dahej Railway Company Limited	₹ 10	13,530,000	13,530,000	10	15
Birla Management Centre Services Limited	₹ 10	9,500	9,500	11	10
Saras Micro Devices Inc. - (f)	USD 13.33	100,000	-	10	-
Addionics Limited	USD 9.25	162,246	-	12	-
				<b>48</b>	<b>30</b>
<b>Debt Instruments at FVTOCI- (a)</b>					
<b>Quoted</b>					
<b>Government Securities- (c)</b>					
6.83% Government of India Bond, 2039		2,000,000	2,000,000	20	20
6.57% Government of India Bond, 2033		5,000,000	5,000,000	48	50
6.45% Government of India Bond, 2029		5,000,000	5,000,000	49	50
5.79% Government of India Bond, 2030		10,000,000	10,000,000	94	96
6.19% Government of India Bond, 2034		10,000,000	10,000,000	92	96
				<b>303</b>	<b>312</b>

# Notes

forming part of the Consolidated Financial Statements

Debt Instruments at FVTPL- (a)	Face value per Unit	Numbers as at		Value as at	
		31/03/2022	31/03/2021	31/03/2022	31/03/2021
<b>Unquoted</b>					
<b>Preference Shares</b>					
Aditya Birla Health Services Limited - 7% Redeemable, Non Cumulative - (d)	₹ 100	2,500,000	2,500,000	24	25
Birla Management Centre Services Limited - 9% Redeemable Cumulative - (e)	₹ 10	-	300	-	-
				24	25
<b>Unquoted</b>					
<b>Mutual Funds</b>					
Investments in Debt Schemes of Mutual Funds				2	4
				2	4
				377	371
				<b>8,616</b>	<b>7,670</b>

(a) Aggregate amount of Quoted and Unquoted Investments, Market value of Quoted Investments are given below:					
Aggregate Cost of Quoted Investments				2,990	3,014
Aggregate Market value of Quoted Investments				8,542	7,611
Aggregate Cost of Unquoted Investments				75	53
Aggregate amount of impairment in value of investments				3	3
Aggregate Carrying value of Quoted and Unquoted Investments				<b>8,616</b>	<b>7,670</b>

- (b) During the previous year, the Group had subscribed to the Rights issue of Aditya Birla Fashion & Retail Limited at ₹ 110 per share (Face value of ₹ 10 and Premium of ₹ 100). The Group had invested ₹ 43 crore (52,57,652 shares at ₹ 82.50 per share) in previous year and Final call of ₹ 14 crore (52,57,652 shares at ₹ 27.50 per share) has been paid during the current year.
- (c) Includes ₹ 25 crore (31/03/2021: ₹ 242 crore) being placed as margin money with counter parties for derivative transactions.
- (d) These are Non Cumulative, Non Convertible Preference Shares and Redeemable within 15 years from the allotment date i.e. March 29, 2019.
- (e) These preference shares are redeemed during current year.
- (f) During the year ended March 31, 2022, Novelis sold 90% of equity ownership in Saras Micro Devices Inc. ('Saras'). The Group currently owns 100,000 shares amounting to ₹ 10 crore (USD 1.33 million) (Refer Note 51).

## 6B. Investments, Current

Refer Note 1B(Q) for accounting policy on Financial Instruments

	Face value per Unit	Numbers as at		Value as at	
		31/03/2022	31/03/2021	31/03/2022	31/03/2021
<b>Quoted- (a)</b>					
Investments in Equity Instruments at FVTOCI					
National Aluminium Company Limited (Fully paid-up)	₹ 5	-	18,385,327	-	99
Investment in Government Securities at FVTOCI - (b), (c)				72	73
Investment in Debentures and Bonds at FVTPL - (b), (c)				152	164
Investment in Debt Schemes of Mutual Funds at FVTPL - (b)				5,228	9,081
				<b>5,452</b>	<b>9,417</b>

(a) Aggregate amount of Quoted and Unquoted Investments, Market value of Quoted investments are given below:

Aggregate cost of Quoted Investments	5,302	9,232
Aggregate Market value of Quoted Investments	5,452	9,417
Aggregate Cost of Unquoted Investments	-	-
Aggregate Carrying value of Quoted and Unquoted Investments	<b>5,452</b>	<b>9,417</b>

- (b) Investment in Debt Schemes of Mutual Funds includes ₹ 320 crore (31/03/2021: Investment in Government Securities ₹ 25 crore) being placed as margin money with counter parties for derivative transactions.
- (c) Details of each of the category of investment mentioned above are available in separate financial statements of respective Group entities.

## 7. Loans

(Unsecured, Considered Good unless otherwise stated)

Refer Note 1B(Q) for accounting policy on Financial Instruments

	As at			
	31/03/2022		31/03/2021	
	Non-Current	Current	Non-Current	Current
Loan to Related Parties - (a) - (refer Note 42)	36	-	-	41
Loan to Employees	13	7	10	6
Loan to Others	1	-	2	-
	<b>50</b>	<b>7</b>	<b>12</b>	<b>47</b>

(a) Disclosure on Loans or Advances in the nature of loans granted to promoters, directors, Key Managerial Personnel (KMPs) and the related parties, that are repayable on demand are as follows:

Type of Borrower <sup>#</sup>	Amount of loan or advance in the nature of loan outstanding		% to the total Loans and Advances in the nature of loans	
	31/03/2022	31/03/2021	31/03/2022	31/03/2021
Promoters	-	-	-	-
Directors	-	-	-	-
KMPs	-	-	-	-
<b>Related Parties:</b>				
Aditya Birla Science & Technology Company Private Limited *	-	41	-	69%

\* There is no outstanding loan as at 31/03/2022 which is repayable on demand.

<sup>#</sup>During the current and previous year there are no Loans or Advances in the nature of loans granted to promoters, directors, KMPs and the related parties, that are without specifying any terms or period of repayment.



# Notes

forming part of the Consolidated Financial Statements

## 8A. Other Financial Assets, Non-Current

(Unsecured, Considered Good unless otherwise stated)

Refer Note 1B(Q) for accounting policy on Financial Instruments

	As at	
	31/03/2022	31/03/2021
Contingent Consideration (measured at fair value through profit and loss) - (refer Note 50)	381	819
Security Deposits - (a), (b)	132	152
Earmarked balances with Banks - (c)	148	142
Deposit with Others - (a)	27	11
Deposit with Non-Banking Financial Company with initial maturity more than 12 months	60	-
Other Receivables - (d)	38	23
	<b>786</b>	<b>1,147</b>

- (a) Refer Note 42 for balances with related parties.
- (b) Includes Security Deposit pledged of ₹ 4 crore (31/03/2021: ₹ 4 crore).
- (c) Earmarked balances includes balance in escrow accounts/ under lien with various authorities for the Company and deposits for employee benefits related to Novelis.
- (d) Include ₹ 23 crore (\$ 3 million) of promissory note entered into upon sale of Saras (refer Note 51).

## 8B. Other Financial Assets, Current

(Unsecured, Considered Good unless otherwise stated)

Refer Note 1B(Q) for accounting policy on Financial Instruments

	As at	
	31/03/2022	31/03/2021
Derivative matured pending realisation	622	306
Security Deposits - (a)	53	24
Deposits with Non Banking Financial Company with initial maturity more than 3 months	915	150
Accrued Interest	57	34
Other Receivables - (a), (b)		
Unsecured, Considered Good	484	697
Unsecured, Considered Doubtful	2	12
Less : Allowance for Doubtful amount	(2)	(12)
	<b>2,131</b>	<b>1,211</b>

- (a) Refer Note 42 for balances with related parties.
- (b) Include ₹ 23 crore (\$ 3 million) of consideration receivable on sale of Saras (Refer Note 51)

## 9. Income Taxes

Refer Note 1B(X) for accounting policy on Income Taxes

### A. Current Tax and Deferred Tax Expense

The Group's income tax expenses and effective tax rate reconciliation given below:

#### (a) Amount recognised in Statement of Profit and Loss

	Year ended	
	31/03/2022	31/03/2021
<b>Current Tax</b>		
Current Tax Expenses for the year	3,802	1,868
Adjustments for current tax of prior periods (Net)	(1)	13
	<b>3,801</b>	<b>1,881</b>
<b>Deferred Tax</b>		
Deferred Income Tax Expenses - (ii)	1,473	1,291
MAT Credit Entitlement	99	(449)
	<b>1,572</b>	<b>842</b>
Income Tax Expenses related to Continuing operations	5,373	2,723
Income Tax Expenses related to Discontinued Operations	7	(367)
<b>Total Income Tax Expenses</b>	<b>5,380</b>	<b>2,356</b>

- i. Applicable Indian Statutory Income Tax rate for the year ended March 31, 2022 and March 31, 2021 is 34.944% and 34.944%, respectively.
- ii. MAT Credit entitlement includes ₹ 298 crore (31/03/2021: ₹ 165 crore) pertaining to Utkal Alumina International Limited.

#### (b) Reconciliation of Effective Tax Rate

	Year ended	
	31/03/2022	31/03/2021
Indian Statutory Income Tax Rate (%)	34.944%	34.944%
Tax expenses using the Company's domestic tax rate	6,678	2,040
Tax effect of adjustments to reconcile reported income tax expense:		
Tax credits and other concessions	(341)	(173)
Income exempt from tax	(152)	(152)
Expenses not deductible in determining taxable profit	290	199
Tax on income (domestic and foreign) at rates different from statutory income tax rate	(404)	76
Adjustments pertaining to prior years	(26)	31
Previously unrecognised tax loss, tax credit or temporary difference of a prior period	(403)	-
Uncertain tax positions	49	32
Tax on Undistributed Earnings	(5)	(1)
Deferred tax not recognised on carry forward losses and benefits	(90)	169
Foreign exchange translation & remeasurement	(264)	72
Others	48	63
<b>Total Tax expenses recognised in the Consolidated Statement of Profit and Loss</b>	<b>5,380</b>	<b>2,356</b>

# Notes

forming part of the Consolidated Financial Statements

## B. Deferred Tax Assets and Liabilities

### i. Deferred Tax Assets (Net)

	As at	
	31/03/2022	31/03/2021
Deferred Tax Assets	1,691	1,285
Deferred Tax Liabilities	(484)	(361)
	<b>1,207</b>	<b>924</b>

Major components of Deferred Tax Assets (Net) arising on account of temporary timing differences and movement thereof are given below:

	As at April 01, 2021	Recognised in Statement of Profit and Loss	Recognised in OCI	Recognised directly in Equity	Exchange Differences	Reclass (DTL/DTA)	As at March 31, 2022
<b>Deferred Tax Assets</b>							
Provisions deductible for tax purposes in future period	722	9	(131)	-	51	-	651
PP&E Depreciation and Intangible Amortisation	80	(23)	-	-	13	-	70
Tax (losses)/benefits carry forwards, net #	311	365	-	-	36	-	712
Inventory valuation reserves	52	57	-	-	-	-	109
Fair value measurements of financial instruments	6	-	-	-	(1)	(5)	-
Trade name	114	30	-	-	5	-	149
Others	-	-	-	-	-	-	-
	<b>1,285</b>	<b>438</b>	<b>(131)</b>	<b>-</b>	<b>104</b>	<b>(5)</b>	<b>1,691</b>
<b>Deferred Tax Liabilities</b>							
PP&E Depreciation and Intangible Amortisation	308	100	-	-	12	-	420
Inventory valuation reserves	-	-	-	-	-	-	-
Cash Flow Hedges	4	-	7	-	-	-	11
Others	49	(4)	-	-	8	-	53
	<b>361</b>	<b>96</b>	<b>7</b>	<b>-</b>	<b>20</b>	<b>-</b>	<b>484</b>
<b>Net Deferred Tax Assets</b>	<b>924</b>	<b>342</b>	<b>(138)</b>	<b>-</b>	<b>84</b>	<b>(5)</b>	<b>1,207</b>

(₹ in Crore)

	As at April 01, 2020	Additions due to Acquisition	Recognised in Statement of Profit and Loss	Recognised in OCI	Recognised directly in Equity	Exchange Differences	As at March 31, 2021
<b>Deferred Tax Assets</b>							
Provisions deductible for tax purposes in future period	1,276	2	(492)	(35)	2	(31)	722
PP&E Depreciation and Intangible Amortisation	77	-	27	-	-	(24)	80
Tax (losses)/benefits carry forwards, net #	235	3	131	-	-	(58)	311
Inventory valuation reserves	18	-	34	-	-	-	52
Cash Flow Hedges	3	-	(3)	-	-	-	-
Fair value measurements of financial instruments	16	-	-	(10)	-	-	6
Trade name	109	-	8	-	-	(3)	114
Others	38	-	(38)	-	-	-	-
	<b>1,772</b>	<b>5</b>	<b>(333)</b>	<b>(45)</b>	<b>2</b>	<b>(116)</b>	<b>1,285</b>
<b>Deferred Tax Liabilities</b>							
PP&E Depreciation and Intangible Amortisation	613	-	(288)	-	-	(17)	308
Inventory valuation reserves	146	-	(144)	-	-	(2)	-
Cash Flow Hedges	-	-	4	-	-	-	4
Others	163	-	(104)	-	-	(10)	49
	<b>922</b>	<b>-</b>	<b>(532)</b>	<b>-</b>	<b>-</b>	<b>(29)</b>	<b>361</b>
<b>Net Deferred Tax Assets</b>	<b>850</b>	<b>5</b>	<b>199</b>	<b>(45)</b>	<b>2</b>	<b>(87)</b>	<b>924</b>

# Tax Losses/Benefits carry forwards represents deferred income tax asset on unabsorbed depreciation carried forward under tax laws for which there is no expiry period.

### ii. Deferred Tax Liabilities (Net)

	As at	
	31/03/2022	31/03/2021
Deferred Tax Liabilities	15,590	14,039
Deferred Tax Assets	(9,959)	(9,509)
	<b>5,631</b>	<b>4,530</b>



# Notes

forming part of the Consolidated Financial Statements

Major components of Deferred Tax Liabilities (Net) arising on account of temporary timing differences and movement therein are given below:

(₹ in Crore)								
	As at April 01, 2021	Additions due to Acquisition	Recognised in Statement of Profit and Loss	Recognised in OCI	Recognised directly in Equity	Exchange Differences	Reclass (DTL/DTA)	As at March 31, 2022
<b>Deferred Tax Liabilities</b>								
PP&E Depreciation and Intangible Amortisation	11,860	23	220	-	-	218	-	12,321
Inventory Valuation Reserves	443	-	1,066	-	-	35	-	1,544
Exchange Differences on Foreign Operations	1,259	-	(354)	-	-	42	-	947
Fair value measurements of financial instruments	45	-	3	240	-	-	(5)	283
Deferred tax on Undistributed earnings	23	-	(5)	-	-	-	-	18
Cash Flow Hedges	3	-	-	-	-	(2)	-	1
Others	406	(3)	46	-	-	27	-	476
	<b>14,039</b>	<b>20</b>	<b>976</b>	<b>240</b>	<b>-</b>	<b>320</b>	<b>(5)</b>	<b>15,590</b>
<b>Deferred Tax Assets</b>								
Tax (losses)/benefits carry forwards, net #	2,707	-	(943)	-	-	62	-	1,826
Retirement Benefits and Compensated Absences	74	-	(13)	3	-	(1)	-	63
Cash Flow Hedges	691	-	-	1,436	(73)	11	-	2,065
Provisions deductible for tax purposes in future period	2,653	-	94	(161)	-	120	-	2,706
MAT Credit entitlement	3,093	-	(99)	-	-	-	-	2,994
PP&E Depreciation and Intangible Amortisation	-	-	2	-	-	-	-	2
Others	291	-	14	(5)	-	3	-	303
	<b>9,509</b>	<b>-</b>	<b>(945)</b>	<b>1,273</b>	<b>(73)</b>	<b>195</b>	<b>-</b>	<b>9,959</b>
<b>Net Deferred Tax Liabilities</b>	<b>4,530</b>	<b>20</b>	<b>1,921</b>	<b>(1,033)</b>	<b>73</b>	<b>125</b>	<b>(5)</b>	<b>5,631</b>

(₹ in Crore)								
	As at April 01, 2020	Additions due to Acquisition	Recognised in Statement of Profit and Loss	Recognised in OCI	Recognised directly in Equity	Exchange Differences	Reclass (DTL/DTA)	As at March 31, 2021
<b>Deferred Tax Liabilities</b>								
PP&E Depreciation and Intangible Amortisation	9,812	1,709	511	-	-	(172)	-	11,860
Inventory Valuation Reserves	434	(44)	58	-	-	(5)	-	443
Exchange Differences on Foreign Operations	1,283	-	14	-	-	(38)	-	1,259
Fair value measurements of financial instruments	140	-	(92)	(3)	-	-	-	45
Deferred tax on Undistributed earnings	23	-	-	-	-	-	-	23
Cash Flow Hedges	117	-	-	(114)	-	-	-	3
Others	157	30	217	-	-	2	-	406
	<b>11,966</b>	<b>1,695</b>	<b>708</b>	<b>(117)</b>	<b>-</b>	<b>(213)</b>	<b>-</b>	<b>14,039</b>

(₹ in Crore)

	As at April 01, 2020	Additions due to Acquisition	Recognised in Statement of Profit and Loss	Recognised in OCI	Recognised directly in Equity	Exchange Differences	Reclass (DTL/DTA)	As at March 31, 2021
<b>Deferred Tax Assets</b>								
Tax (losses)/benefits carry forwards, net #	2,510	1,154	(913)	-	-	(44)	-	2,707
Retirement Benefits and Compensated Absences	104	-	(11)	(19)	-	-	-	74
Cash Flow Hedges	229	-	-	453	17	(8)	-	691
Provisions deductible for tax purposes in future period	1,600	920	459	(262)	-	(64)	-	2,653
MAT Credit entitlement	2,644	-	449	-	-	-	-	3,093
PP&E Depreciation and Intangible Amortisation	-	-	-	-	-	-	-	-
Others	266	-	22	-	-	3	-	291
	<b>7,353</b>	<b>2,074</b>	<b>6</b>	<b>172</b>	<b>17</b>	<b>(113)</b>	<b>-</b>	<b>9,509</b>
<b>Net Deferred Tax Liabilities</b>	<b>4,613</b>	<b>(379)</b>	<b>702</b>	<b>(289)</b>	<b>(17)</b>	<b>(100)</b>	<b>-</b>	<b>4,530</b>

# Tax Losses/Benefits carry forwards represents deferred income tax asset on unabsorbed depreciation carried forward under tax laws for which there is no expiry period.

Net deferred tax liability includes ₹ 544 crore (31/03/2021: ₹ 239 crore) pertaining to Utkal Alumina International Limited including MAT Credit entitlement of ₹ 954 crore (31/03/2021: ₹ 656 crore).

### iii. Unrecognised Deferred Taxes

			(₹ in Crore)	
			As at	
			31/03/2022	31/03/2021
(a)	Cumulative earnings in respect of certain Group entities for which the Group has not provided deferred tax liability. The Group believe that the reversal of such temporary difference is not probable in the foreseeable future.		34,352	31,544
(b)	The following Deferred Tax Assets have not been recognised at the reporting date as it is not probable of recovery.			
<b>Un-expiring</b>				
i.	Unabsorbed Depreciation and other expenses not deductible for tax		780	797
ii.	Tax losses carry forwards		181	127
iii.	Unused tax credits		582	547
<b>Expiring</b>				
i.	Carried forward Tax losses		13,671	14,454
	Period of expiry		FY 2023-43	FY 2022-41
ii.	Unused tax credits		355	413
	Period of expiry		FY 2023-33	FY 2022-33
iii.	Long term capital loss carry forward		964	995
	Period of expiry		FY 2023-25	FY 2022-25
iv.	Unabsorbed Depreciation and other expenses not deductible for tax		-	8
	Period of expiry		-	FY 2029

# Notes

forming part of the Consolidated Financial Statements

The Group has not recognised deferred tax asset in respect of deductible temporary differences related to its equity investments measured at FVTOCI as presently it is not probable that future taxable long term capital gain will be available in the foreseeable future to recover such deferred tax assets.

Deferred tax assets and deferred tax liabilities have been offset wherever the Group has a legally enforceable right to set-off current tax assets against current tax liabilities and where the deferred tax assets and deferred tax liabilities relate to income tax levied by the same taxation authority. The Group has not recognised deferred tax on temporary differences relating to depreciation which originate and reverse during the tax holiday period.

- iv. During current year, after considering all available evidence, the Group recognised deferred tax assets in Novelis Inc., Canada, resulting in a total benefit of ₹ 554 crore (\$ 73 million). Out of this, ₹ 403 crore (\$ 54 million) is related to forecasted net operating losses utilization in future periods and is broken out separately in the reconciliation of effective tax rate. Positive evidence for Novelis Inc. included a recent history of its three-year cumulative earnings as at March 31, 2022 and its forecasted taxable earnings, as a result of a decrease in its external interest expense, an increase in its interest income from intercompany indebtedness, and patent fees through 2031. Negative evidence included its overall size and history of recurring losses. After weighing the available evidence, the Group determined it is probable that taxable profits will be available in Novelis Inc. to utilize a portion of the Canadian net operating losses.

**v. Tax Uncertainties:**

As of March 31, 2022 and March 31, 2021 the total amount of unrecognized benefits in Novelis that, if recognized, would affect the effective income tax rate in future periods based on anticipated settlement dates is ₹ 541 crore (USD 71 million) and ₹ 501 crore (USD 69 million), respectively.

Tax authorities continue to examine certain other tax filings of Novelis for financial years 2005 through 2019. As a result of further settlement of audits, judicial decisions, the filing of amended tax returns or the expiration of statutes of limitations, Novelis' reserves for unrecognized tax benefits, as well as its reserves for interest and penalties, are not expected to decrease in the next 12 months. With few exceptions, tax returns for all jurisdictions for all tax years before 2005 are no longer subject to examination by taxing authorities.

As of March 31, 2022 and March 31, 2021, Novelis had ₹ 73 crore (\$ 10 million) and ₹ 81 crore (\$ 11 million) accrued, respectively, for interest and penalties. For the years ended March 31, 2022 and 2021 Novelis recognized interest and penalties expense (benefit) of ₹ (12) crore (\$ -2 million) and interest and penalties expense of ₹ 16 crore (approximately \$ 2 million).

- vi. The Taxation Law (Amendments) Ordinance 2019 ('the Ordinance'), in India provides an option to domestic companies to pay income-tax at a lower rate of 22% (plus applicable surcharge and cess) instead of the normal rate of 30% (plus applicable surcharge and cess) depending on the conditions specified in this behalf under section 115BBA of the Income Tax Act, 1961. A domestic company can avail of the lower tax rate only if it opts for not availing of certain exemptions or incentives specified in this behalf in the Ordinance. There is no time limit prescribed under the above to choose the option of lower tax rate under section 115BAA, however, once chosen it is irreversible.

The Group has accumulated MAT credit and tax incentives to be availed/adjusted against future taxable profits. Based on the projections prepared by the management, including its plan for future capital expenditure for capacity enhancement, the Group has determined that exercising the option of lower rate will be beneficial only in the long term. Accordingly, certain domestic companies in the Group have not exercised this option during the period and continue to recognize the taxes on income for year ended March 31, 2022 as per the existing normal tax rate of 30% (plus applicable surcharge and cess).

The Parent Company and some of its Indian subsidiaries have assessed that its net deferred tax liability as at March 31, 2022 would get reversed within the period for which company is expected to continue to be in the existing tax regime. The Group will review the above position at each year end.

**C. Income Tax Assets and Liabilities with Tax Authorities**

	(₹ in Crore)	
	As at	
	31/03/2022	31/03/2021
<b>i. Income Tax Assets (Net)</b>		
Non-Current Tax Assets (Net)	8	4
Current Tax Assets (Net)	186	207
	<b>194</b>	<b>211</b>
<b>ii. Income Tax Liabilities (Net)</b>		
Current Tax Liabilities	2,120	2,126
	<b>2,120</b>	<b>2,126</b>

The Group is subject to tax assessments and ongoing proceedings, which are pending before various Tax Authorities. Management periodically evaluates the positions taken in tax returns with respect to above matters, including unresolved tax disputes, which involves interpretation of applicable tax regulations and judicial precedents. Current tax liability and tax asset balances are presented, after recognising as appropriate, provision for taxes payable and contingencies basis Management's assessment of outcome of such ongoing proceedings and amounts that may become payable to the tax authorities. Considering the nature of such estimates and uncertainties involved, the amount of such provisions may change upon final resolution of the matters with tax authorities. Also refer Note 1D.

**10. Other Non-Current and Current Assets  
(Unsecured, Considered Good unless otherwise stated)**

	(₹ in Crore)			
	As at			
	31/03/2022		31/03/2021	
	Non-Current	Current	Non-Current	Current
Capital Advance	547	-	302	-
Trade Advances and Deposits - (a)	10	1,256	120	653
Deposits with Government and Other Authorities	17	30	216	37
Prepaid Expenses	103	714	48	583
Others				
Unsecured, Considered Good - (b), (c)	1,000	2362	839	1,400
Unsecured, Considered Doubtful				
Advance to Supplier for Goods and Services	22	108	12	108
Others	-	11	-	12
Less : Allowance for Doubtful amount	(22)	(119)	(12)	(120)
	<b>1,677</b>	<b>4,362</b>	<b>1,525</b>	<b>2,673</b>

- (a) Refer Note 42 for balances with related parties.
- (b) It mainly includes unutilised tax credits and claims receivable from Indirect Tax Authorities.
- (c) It also includes ₹ 192 crore (Garepalma ₹ 74 crore and Kathautia ₹ 118 crore) [31/03/2021: ₹ 192 crore (Garepalma ₹ 74 crore and Kathautia ₹ 118 crore)] towards appropriation of Performance Bank Guarantee by Nominated Authority. Refer note - 52 for further details.



# Notes

forming part of the Consolidated Financial Statements

## 11. Inventories

Refer Note 1B(N) for accounting policy on Inventories

	As at					
	31/03/2022			31/03/2021		
	In Hand	In Transit	Total	In Hand	In Transit	Total
Raw Materials	7,293	5,852	13,145	4,587	5335	9,922
Work-in-Progress	20,185	249	20,434	13,318	121	13,439
Finished Goods	6,900	280	7,180	4,670	199	4,869
Stock-in-Trade	884	-	884	4	-	4
Stores and Spares	2,329	18	2,347	1,969	55	2,024
Coal and Fuel	474	19	493	396	14	410
	<b>38,065</b>	<b>6,418</b>	<b>44,483</b>	<b>24,944</b>	<b>5,724</b>	<b>30,668</b>

- (a) For Inventories hypothecated against secured short-term borrowings, refer Note 18B.
- (b) The Group has extended fair value hedge accounting on its inventory which forms part of Work-in-Progress and Finished Goods. Fair value hedges are mainly used to hedge the exposure to change in fair value of commodity price risks. The fair value adjustment remains part of the carrying value of inventory and is taken to profit and loss when the inventory is sold or consumed. Refer Note 46(B)(a)
- (c) Write down of inventories (net of reversal) to net realizable value amounted to ₹ 612 crore (31/03/2021: ₹ 377 crore). These were recognized as expense and included in 'Cost of Material Consumed' and 'Changes in Inventories of Finished Goods, Work-in-Progress and Stock-in-Trade' in the Consolidated Statement of Profit and Loss.
- (d) Inventories in hand include bulk material of coal, bauxite and copper concentrate lying at yards, mines, plants, precious metals of gold and silver lying at smelter and refinery aggregating to ₹ 4,302 crore (31/03/2021: ₹ 3,179 crore).

## 12. Trade Receivables

Refer Note 1B(O) for accounting policy on Trade Receivable

	As at			
	31/03/2022		31/03/2021	
	Non-Current	Current	Non-Current	Current
Trade Receivables:				
Secured, Considered Good	-	2,083	-	1,767
Secured, Credit Impaired	-	6	-	9
Unsecured, Considered Good	-	19,011	53	11,202
Unsecured, Credit Impaired	-	60	-	58
	-	<b>21,160</b>	<b>53</b>	<b>13,036</b>
Less: Loss Allowances - (c)	-	(84)	-	(77)
	-	<b>21,076</b>	<b>53</b>	<b>12,959</b>

(a) Trade Receivables ageing schedule as at 31/03/2022:

Particulars	Unbilled	Not Due	Outstanding for following periods from due date of receipt					Total
			Less than 6 months	6 months - 1 year	1 - 2 years	2 - 3 years	More than 3 years	
<b>Secured</b>								
(i) Secured, Considered Good	-	2,023	53	5	-	-	-	2,081
(ii) Secured, Credit Impaired	-	-	-	2	2	1	1	6
<b>Unsecured</b>								
(i) Undisputed – considered good	34	18,685	170	26	24	2	6	18,947
(ii) Undisputed – significant increase in credit risk	-	-	-	-	-	-	1	1
(iii) Undisputed – credit impaired	-	-	-	3	4	2	11	20
(iv) Disputed – considered good	5	-	31	-	29	3	-	68
(v) Disputed – significant increase in credit risk	-	-	-	-	-	-	21	21
(vi) Disputed – credit impaired	-	-	-	-	-	-	15	15
	<b>39</b>	<b>20,708</b>	<b>254</b>	<b>36</b>	<b>59</b>	<b>8</b>	<b>55</b>	<b>21,159</b>
Less: Loss Allowances								(83)
<b>Total</b>								<b>21,076</b>

Trade Receivables ageing schedule as at 31/03/2021:

Particulars	Unbilled	Not Due	Outstanding for following periods from due date of receipt					Total
			Less than 6 months	6 months - 1 year	1 - 2 years	2 - 3 years	More than 3 years	
<b>Secured</b>								
(i) Secured, Considered Good	-	1,790	26	-	-	-	-	1,816
(ii) Secured, Credit Impaired	-	-	-	2	3	2	2	9
<b>Unsecured</b>								
(i) Undisputed – considered good	52	10,756	307	38	6	2	10	11,171
(ii) Undisputed – significant increase in credit risk	-	-	-	-	-	-	-	-
(iii) Undisputed – credit impaired	-	-	-	3	4	2	11	20
(iv) Disputed – considered good	5	1	-	-	28	-	-	34
(v) Disputed – significant increase in credit risk	-	-	-	-	-	-	-	-
(vi) Disputed – credit impaired	-	-	-	-	-	1	33	34
	<b>57</b>	<b>12,547</b>	<b>333</b>	<b>43</b>	<b>41</b>	<b>7</b>	<b>56</b>	<b>13,084</b>
Less: Loss Allowances								(72)
<b>Total</b>								<b>13,012</b>

# Notes

forming part of the Consolidated Financial Statements

- (b) No trade or other receivable are due from directors or other officers of the Company either severally or jointly with any other person. Further, no trade or other receivable are due from firms or private companies respectively in which any director is a partner, or director or member.
- (c) For trade receivables hypothecated against borrowings, refer Note 18B.
- (d) Loss allowances includes provision of ₹ 24 crore (31/03/2021: ₹ 19 crore) made on account of expected credit loss on Trade Receivables. Refer Note 46(A)(c)
- (e) Refer Note 42 for balances with related parties.

## 13. Cash and Cash Equivalents

Refer Note 1B(S) for accounting policy on Cash and Cash Equivalents

	(₹ in Crore)	
	As at	
	31/03/2022	31/03/2021
Cash on Hand	-	-
Cheques and Drafts on Hand - (a)	14	8
<b>Balance with Banks</b>		
Current Accounts	6,630	5,514
Deposits with Initial Maturity of less than three months	4,333	2,048
Short term Liquid Investments in Mutual Funds	662	769
	<b>11,639</b>	<b>8,339</b>

- (a) Includes ₹ Nil crore (31/03/2021: ₹ 3 crore) remittance in transit.
- (b) There is no restriction with regard to cash and cash equivalents as the end of reporting year and prior years.

## 14. Bank Balances other than Cash and Cash Equivalents

Refer Note 1B(Q) for accounting policy on Financial Instruments

	(₹ in Crore)	
	As at	
	31/03/2022	31/03/2021
<b>Balances with Banks</b>		
Earmarked balances - (a), (b)	16	116
Deposits with Initial Maturity more than three months	5,737	354
	<b>5,753</b>	<b>470</b>

- (a) Includes unclaimed dividend of ₹ 5 crore (31/03/2021: ₹ 4 crore).
- (b) It also includes an amount of ₹ Nil (31/03/2021: ₹ 102 crore) deposited in an account restricted for repayment of an unsecured term loan.

## 15. Non-Current Assets or Disposal Group Classified as Held for Sale

Refer Note 1B(H) for accounting policy on Non-Current assets (or Disposal Groups) Held for Sale

	(₹ in Crore)	
	As at	
	31/03/2022	31/03/2021
<b>A. Assets or Disposal Group Classified as Held for Sale</b>		
Non-Current Assets classified as held for sale - (a), (b)	42	45
Assets of Disposal Group classified as held for sale - (c)	46	107
	<b>88</b>	<b>152</b>

- (a) As at March 31, 2022 assets held for sale of ₹ 39 crore (March 31, 2021: ₹ 41 crore) relate to one of the hydroelectric power generation facilities in South America, Brecha, land and building of Binh Duong plant in Vietnam. (refer Note 34 for reversal of impairment)

- (b) Details of Assets classified as held for sale by the Parent Company

Land and Building	1	1
Plant and Equipment	2	3
	<b>3</b>	<b>4</b>

- (c) Details of Assets of Disposal Group classified as held for sale

Other Assets - (i)	46	107
	<b>46</b>	<b>107</b>

- (i) Represents assets of discontinued operation classified as held for sale. - (refer Note 50)
- (ii) During the year the Group has recognised impairment loss of ₹ Nil crore (31/03/2021: ₹ 25 crore) on Assets which are held for disposal. - (refer Note 34)
- (iii) The fair value of the assets held for sale approximates the carrying value.

## B. Liability Associated with Disposal Group Classified as Held for Sale

Liabilities associated with Disposal Group classified as held for Sale - (a)	93	119
	<b>93</b>	<b>119</b>

- (a) Represents liabilities of discontinued operation classified as held for sale. - (refer Note 50)



# Notes

forming part of the Consolidated Financial Statements

## 16. Equity Share Capital

	(₹ in Crore)	
	As at	
	31/03/2022	31/03/2021
<b>Authorized</b>		
2,500,000,000 (as at 31/03/2021 : 2,500,000,000) Equity Shares of ₹ 1/- each	250	250
25,000,000 (31/03/2021: 25,000,000) Redeemable Cumulative Preference Shares of ₹ 2/- each	5	5
	<b>255</b>	<b>255</b>
<b>Issued</b>		
2,247,726,370 (as at 31/03/2021: 2,247,237,893) Equity Shares of ₹ 1/- each - (a)	225	225
	<b>225</b>	<b>225</b>
<b>Subscribed and Paid-up</b>		
2,247,718,973 (as at 31/03/2021: 2,247,230,496 ) Equity Shares of ₹ 1/- each fully paid-up	225	225
Less: Face value of 546,249 (31/03/2021: 546,249) Equity Shares forfeited	-	-
Add: Forfeited Shares (Amount originally Paid-up)	-	-
	<b>225</b>	<b>225</b>
Less: Treasury Shares		
16,316,130 (31/03/2021: 16,316,130) Equity Shares held as Treasury Shares - (b)	(2)	(2)
7,064,997 (31/03/2021: 5,824,965) Equity Shares held as Treasury Shares by ESOP Trust - (c)	(1)	(1)
	<b>222</b>	<b>222</b>

- (a) Issued Equity Share Capital as at 31/03/2022 includes 7,397 Equity Shares (31/03/2021: 7,397) of ₹ 1/- each issued on Rights basis kept in abeyance due to legal case pending.
- (b) Treasury shares include shares held by Trident Trust which represents 16,316,130 equity shares (31/03/2021: 16,316,130 Equity Shares) of ₹ 1/- each fully paid-up of the Company issued, pursuant to a Scheme of Arrangements approved by the Hon'ble High Courts of Mumbai and of Allahabad, vide their Orders dated October 31, 2002, and November 18, 2002, respectively, to the Trident Trust, created wholly for the benefit of the Company and is being managed by trustees appointed by it. The tenure of the Trust is up to January 23, 2024.
- (c) Treasury shares include shares held by Hindalco Employee Welfare Trust (ESOP Trust) which represents 7,064,997 equity shares (31/03/2021: 5,824,965 Equity Shares) of ₹ 1/- each fully paid up of the Company. The Trust buys shares of the Company from the market, for giving shares to employees pursuant to the Employees Stock Option Scheme, 2018. - (refer Note 17(A)(ix))
- (d) Reconciliation of shares outstanding at the beginning and at the end of the reporting period:

	As at			
	31/03/2022		31/03/2021	
	Numbers	₹ in Crore	Numbers	₹ in Crore
Equity Shares outstanding at the beginning of the year	2,224,543,152	222	2,224,020,885	222
Equity Shares allotted pursuant to exercise of Employee Stock Option Scheme (ESOS)	488,477	-	461,560	-
Equity shares purchased by Hindalco Employee Welfare Trust from market pursuant to ESOS	(2,119,000)	-	-	-
Equity shares allotted pursuant to exercise of ESOS through Hindalco Employee Welfare Trust	878,968	-	60,707	-
<b>Equity Shares outstanding at the end of the year</b>	<b>2,223,791,597</b>	<b>222</b>	<b>2,224,543,152</b>	<b>222</b>

- (e) Rights, preferences and restrictions attached to Equity Shares:

The Company has one class of equity shares having a par value of ₹ 1/- per share. Each shareholder is eligible for one vote per share held. The dividend proposed by the Board of Directors is subject to the approval of the shareholders in the ensuing Annual General Meeting, except in case of interim dividend. In the event of liquidation, the equity shareholders are eligible to receive the remaining assets of the Company after distribution of all preferential amounts, in proportion to their shareholding.

- (f) Details of shareholders holding more than 5% Equity Shares in the Company on reporting date:

	As at			
	31/03/2022		31/03/2021	
	Numbers of Shares held	Percentage of Holding *	Numbers of Shares held	Percentage of Holding *
IGH Holdings Private Limited	350,088,487	15.58%	349,963,487	15.58%
Birla Group Holdings Private Limited	228,292,308	10.16%	228,292,308	10.16%
Life Insurance Corporation of India and its Associates	189,588,459	8.44%	203,135,624	9.04%
Morgan Guaranty Trust Company of New York	98,270,986	4.37%	151,010,943	6.72%

\*Percentage have been calculated on the basis of total number of shares outstanding before adjusting shares held by Trident Trust and ESOP Trust. Refer footnote (b) and (c) above.

- (g) Shares held by promoters at the end of the year and Movement:

Promoter's Name <sup>5</sup>	No. of Shares as at 31/03/2022	Percentage of Holding * on 31/03/2022	No. of Shares as at 31/03/2021	Percentage of Holding * on 31/03/2021	% Change during the Year
Kumar Mangalam Birla	901,635	0.04%	901,635	0.04%	-
Birla Group Holdings Private Limited	228,292,308	10.16%	228,292,308	10.16%	-
<b>Total</b>	<b>229,193,943</b>		<b>229,193,943</b>		

<sup>5</sup>Promoter here means promoter as defined in Section 2(69) of the Companies Act, 2013.

\*Percentage have been calculated on the basis of total number of shares outstanding before adjusting shares held by Trident Trust and ESOP Trust. Refer footnote (b) and (c) above.

- (h) Shares reserved for issue under options:

The Company has reserved equity shares for issue under the Employee Stock Option Schemes. (Refer Note 41 for details of Employee Stock Option Scheme).

- (i) The Company during the preceding 5 years:

- i. Has not allotted shares pursuant to contracts without payment received in cash.
- ii. Has not issued shares by way of bonus shares.
- iii. Has not bought back any shares.

- (j) The Board of Directors of the Company has recommended dividend of ₹ 4 per share aggregating to ₹ 899 crore for the year ended March 31, 2022 which has not been recognised in the Consolidated Financial Statements.

# Notes

forming part of the Consolidated Financial Statements

## 17. Other Equity

	(₹ in Crore)	
	As at	
	31/03/2022	31/03/2021
Share Application Money pending Allotment	-	-
Equity Component of Other Financial Instruments	4	4
<b>Reserve and Surplus</b>		
Capital Reserve	147	147
Capital Redemption Reserve	104	104
Business Reconstruction Reserve	5,799	5,799
Securities Premium	8,234	8,225
Debenture Redemption Reserve	1,500	1,350
Employees Stock Options	75	54
Treasury Shares held by ESOP Trust	(199)	(129)
Special Reserve	20	20
General Reserve	21,370	21,370
Retained Earnings	36,810	22,777
	<b>73,860</b>	<b>59,717</b>
<b>Other Reserves</b>		
Gain/ (Loss) on Equity Instruments FVTOCI	5,334	4,673
Gain/ (Loss) on Debt Instruments FVTOCI	(5)	1
Effective portion of Cash Flow Hedge	(4,894)	(1,246)
Cost of Hedging Reserve	(39)	10
Foreign Currency Translation Reserve	3,709	3,152
	<b>4,105</b>	<b>6,590</b>
	<b>77,969</b>	<b>66,311</b>

### (A) Brief description of items of Other Equity are given below:

(i) **Share Application Money Pending Allotment:**

Share application money pending allotment represents amount received from employees who has exercised Employee Stock Option Scheme (ESOS) for which shares are pending allotment as on balance sheet date.

(ii) **Equity Component of Other Financial Instruments:**

It represents fair valuation gain of inter-corporate deposits taken in earlier years by Associate entities on transition to Ind AS.

(iii) **Capital Reserve:**

The Group has created capital reserve pursuant to past mergers and acquisitions.

(iv) **Capital Redemption Reserve:**

The Group has created capital redemption reserve as per the requirement of the Companies Act.

(v) **Business Reconstruction Reserve**

The Company had formulated a scheme of financial restructuring under sections 391 to 394 of the Companies Act 1956 ("the Scheme") between the Company and its equity shareholders approved by the High Court of judicature of

Bombay to deal with various costs associated with its organic and inorganic growth plan. Pursuant to this, a separate reserve account titled as Business Reconstruction Reserve ("BRR") was created during the year 2008-09 by transferring balance standing to the credit of Securities Premium Account of the Company for adjustment of certain expenses as prescribed in the Scheme.

(vi) **Securities Premium:**

Securities premium reserve is used to record the premium on issue of shares. The reserve is utilized in accordance with the provision of the Act.

(vii) **Debenture Redemption Reserve:**

The Group is required to create a debenture redemption reserve out of the profits which is available for payment of dividend, for the purpose of redemption of debentures.

(viii) **Employees Stock Options:**

The employee stock option account is used to recognize the grant date fair value of options issued to employees under stock option schemes.

(ix) **Treasury Shares held by ESOP Trust**

The Company has created a trust, namely "Hindalco Employee Welfare Trust" (ESOP Trust) for providing share-based payments to its employees (including its Subsidiaries' employees). The Company uses this Trust as a vehicle for distributing shares to employees covered under Scheme. The Trust buys shares of the Company from the market, for giving shares to employees under the Employees Stock Option Scheme, 2018.

Shares held by the Trust are treated as Treasury shares. Equity instruments that are reacquired (treasury shares) are recognised at cost and deducted from equity. No gain or loss is recognised in the Consolidated Statement of Profit and Loss on purchase, sale, issue or cancellation of Equity instruments. Share options whenever exercised, would be utilised from these treasury shares. Refer Note 41

(x) **Special Reserve**

Certain subsidiaries of the Group are registered as non-banking financial company and as per requirement of Section 45-IC of the Reserve Bank of India Act, 1934 every non-banking financial company shall create a reserve fund and transfer therein a sum not less than twenty per cent of its net profit every year as disclosed in the profit and loss account and before any dividend is declared.

(xi) **General Reserve**

The Group has created this reserve by transferring certain amount out of the profit at the time of distribution of dividend in the past.

(xii) **Retained Earnings**

Amount of retained earnings represents accumulated profit and losses of the Group as on reporting date. Such profits and losses are after adjustment of payment of dividend, transfer to any reserves as statutorily required and adjustment for realised gain/loss on derecognition of equity instruments measured at FVTOCI. Actuarial Gain/ Loss arising out of Actuarial valuation is immediately transferred to Retained Earnings.

(xiii) **Other Reserve**

a) **Gain/(Loss) on equity and debt instruments accounted as FVTOCI**

The Group has elected to recognize changes in the fair value of certain investments in other comprehensive income. These changes are accumulated within the FVTOCI equity investments reserve and FVTOCI debt investment reserve within equity.



# Notes

forming part of the Consolidated Financial Statements

## b) Effective portion of Cash Flow Hedge

The Group uses hedging instruments as part of its risk management policy for commodity and foreign currency risk as described in Note 46. The Cash Flow hedging reserve is used to recognise the effective portion of gain or loss on designated hedging relationship. (Refer Note 46 (E) and 46 (F) (i)).

## c) Cost of Hedging Reserve

The Group designates the spot component of cross currency interest rate swap as hedging instruments in fair value hedge relationship and cash flow hedge relationship. The Group defers changes in the forward element of cross currency interest rate swap in the cost of hedging reserve. For fair value hedge forward points at inception is amortized on a straight line basis from OCI based on the remaining life of trade. For cash flow hedge the deferred cost of hedging are included in the initial cost of the related hedged items when it is recognized or reclassified to the Consolidated Statement of Profit and Loss when the hedged item effects the Consolidated Statement of Profit and Loss. The Group also designates the intrinsic value of the option contracts whereas the time value of option contracts is included in the cost of hedging reserve. (Refer Note 46 (E) and 46 (F) (ii)).

## d) Foreign Currency Translation Reserve

Foreign Currency Translation reserve includes all resulting exchange differences arising from (a) translating the assets and liabilities of the Group's foreign operations into Indian Rupees using exchange rates prevailing at the end of each reporting period and (b) translating income and expense items of the foreign operations at the average exchange rates for the period.

(B) Movement of each item of other equity is presented in Consolidated Statement of Changes in Equity (SOCE).

## 18A. Borrowings, Non-Current

Refer Note 1B(Q) for accounting policy on Financial Instruments

Particulars	As at					
	31/03/2022			31/03/2021		
	Non-Current Portion	Current Maturities	Total	Non-Current Portion	Current Maturities	Total
<b>Secured</b>						
Debtentures						
Non Convertible Debtentures-(a)	-	5,999	5,999	5,997	-	5,997
Term Loans:						
From Banks						
Rupee Term Loans - (b)	14,227	14	14,241	11,731	8	11,739
Foreign Currency Term Loans - (c)	9,274	98	9,372	14,111	916	15,027
	<b>23,501</b>	<b>6,111</b>	<b>29,612</b>	<b>31,839</b>	<b>924</b>	<b>32,763</b>
<b>Unsecured</b>						
Senior Notes - (d)	27,222	-	27,222	26,581	-	26,581
Term Loans:						
From Banks						
Foreign Currency Term Loans - (e)	905	48	953	541	22	563
Deferred Payment Liabilities - (f)	7	18	25	24	18	42
	<b>28,134</b>	<b>66</b>	<b>28,200</b>	<b>27,146</b>	<b>40</b>	<b>27,186</b>
	<b>51,635</b>	<b>6,177</b>	<b>57,812</b>	<b>58,985</b>	<b>964</b>	<b>59,949</b>

## (a) Debtentures comprise of following:

	As at					
	31/03/2022		31/03/2021		Redemption Date	
	Gross Amount	Carrying Value	Gross Amount	Carrying Value		
30,000 9.55% Redeemable Non Convertible Debtentures of ₹ 10 lakhs each	3,000	3,000	3,000	2,999	25/04/2022	
15,000 9.55% Redeemable Non Convertible Debtentures of ₹ 10 lakhs each	1,500	1,500	1,500	1,499	27/06/2022	
15,000 9.60% Redeemable Non Convertible Debtentures of ₹ 10 lakhs each	1,500	1,499	1,500	1,499	02/08/2022	
	<b>6,000</b>	<b>5,999</b>	<b>6,000</b>	<b>5,997</b>		

All the above Debtentures are secured by all the movable items of Property, Plant and Equipment, both present and future (except movable assets of Mahan Aluminium plant, Aditya Aluminium plant, Kalwa plant and Current Assets) and certain immovable properties of the Parent. - (refer Note 2A)

## (b) Secured Rupee Term Loans from Banks comprise of following:

	Footnote	As at				Redemption Date
		31/03/2022		31/03/2021		
		Gross Amount	Carrying Value	Gross Amount	Carrying Value	
Axis Bank - (Repo Rate + 275 bps )	(i)	619	602	619	610	31-03-2030
State Bank of India - (MCLR 3 Month + 10 bps)	(i)	2,239	2,216	2,239	2,227	31-03-2030
ICICI Bank - (Repo Rate + 275 bps *)	(i)	76	75	84	84	31-03-2030
State Bank of India - (MCLR 3 Month + 10 bps)	(ii)	4,672	4,665	4,672	4,657	01-09-2030
PNB Bank - (MCLR 1 Month + 5 bps )	(ii)	256	255	256	254	01-09-2030
Axis Bank - (Repo Rate + 275 bps )	(ii)	1,371	1,363	1,371	1,352	01-09-2030
State Bank of India - (MCLR 3 Month + 15 bps)	(i)	2,500	2,500	-	-	31-12-2031
Axis Bank - (Policy Repo Rate+275 bps/ SBI 3M MCLR+10 bps/ Axis Bank 1M MCLR)	(iii)	635	631	635	626	30-09-2030
State Bank of India - (MCLR 3 Month + 10 bps)	(iii)	1,789	1,784	1,789	1,779	30-09-2030
State Bank of India - (MCLR 3 Month + 15 bps)	(iii)	150	150	150	150	30-09-2030
		<b>14,307</b>	<b>14,241</b>	<b>11,815</b>	<b>11,739</b>	

\*Benchmark changed w.e.f. February 2022. Previous benchmark was T-bill.

Definition of abbreviation used

- (i) 100 basis points (bps) is equal to 1%
- (ii) Repo rate is the rate at which RBI lends funds to commercial banks
- (iii) Marginal Cost of funds based Lending Rate (MCLR) is a tenor-linked internal benchmark rate of respective bank
- (iv) Treasury Bill (T-bill) means the rate of interest published by the Financial Benchmarks India Pvt. Ltd. ("FBIL").

# Notes

forming part of the Consolidated Financial Statements

- (i) Rupee Term Loans of Mahan Unit: The term loans from banks of ₹ 2,934 crore (carrying amount: ₹ 2,893 crore) are secured by a first ranking charge/ mortgage/ security interest in respect of all the moveable Property, Plant and Equipment and all the immoveable properties of Mahan Aluminium plant, both present and future. ₹ 2,858 crore (carrying value: ₹ 2,818 crore) is to be repaid in 16 quarterly instalments commencing from June 2026. ₹ 76 crore (carrying value: ₹ 75 crore) is to be repaid in 32 quarterly instalments as per original repayment schedule effective June 2020.

The term loan of ₹ 2,500 crore (carrying amount: ₹ 2,500 crore) is secured by a first ranking charge/ mortgage/security interest in respect of all the moveable and immovable items of Property, Plant and Equipment of Mahan Aluminium plant, both present and future. ₹ 2,500 crore (carrying amount: ₹ 2,500 crore) is to be repaid in 34 quarterly instalments commencing from September 2023.

- (ii) Rupee Term Loans of Aditya Unit: The term loans from banks of ₹ 6,299 crore (carrying value: ₹ 6,283 crore) is secured by a first ranking charge/ mortgage/security interest in respect of its all the moveable and immovable Property, Plant and Equipment of Aditya Aluminium Project both present and future. ₹ 6,299 crore is to be repaid in 26 quarterly instalments commencing from May 2024.

- (iii) The term loan from banks in Group's subsidiary Utkal Alumina International Limited (Utkal) of ₹ 2,574 crore (carrying value ₹ 2,565 crore), is secured by (a) first ranking pari-passu mortgage/ Security Interest in respect of all of its immovable properties (excluding the forest land and land surrendered for rehabilitation and resettlement colony) (b) first ranking charge on movable assets (including movable machinery, machinery spares, tools and accessories) both present and future, pertaining to the project (c) second charge on the current assets of Utkal (excluding cash and cash equivalents and investments) both present and future.

This includes term loans of ₹ 2,424 crore (carrying value ₹ 2,415 crore), are repayable in 60 quarterly instalments as per the agreed repayment schedule commenced from December 31, 2015. During the year ended March 31, 2018, Utkal has prepaid all instalments of the loan due up to June & September 30, 2025 to respective banks. The balance principal would be paid as per remaining schedule in quarterly instalments up to September 30, 2030.

The term loans of ₹ 150 crore (carrying value ₹ 150 crore), is repayable in 34 structured quarterly instalments starting from 18th month from the date of first drawdown.

## (c) Secured Foreign Currency Term Loans from Banks comprise of following:

- i. **Foreign currency term loan from Bank of Tokyo Mitsubishi (BTMU)**

Foreign currency term loan pertained to loan from Bank of Tokyo Mitsubishi (BTMU) of \$ 40 million (gross ₹ 293 crore, carrying value ₹ 291 crore) and \$ 22.79 million (gross ₹ 167 crore, carrying value ₹ 166 crore). BTMU loan was secured by a pari-passu first charge on all movable Property, Plant and Equipment of Mahan Aluminium plant, both present and future. The loans were to be repaid in a single instalment at the end of the tenure. The Group has prepaid both the loans in April 2021.

- ii. **Floating rate Term Loan facility**

### 2017 Term Loans:

In January 2017, Novelis borrowed ₹ 13,167 crore (\$ 1.8 billion) of term loans (the "2017 Term Loans") under its Term Loan Facility. The 2017 Term Loans mature on June 2, 2022 and are subject to 0.25% quarterly amortization payments. The existing loans under the Term Loan Facility accrue interest at LIBOR plus 1.85%

During previous year Novelis made ₹ 8,974 crore (\$ 1.1 billion) in principal payments beyond its scheduled quarterly amortization payments on its 2017 Term Loans using the proceeds from the issuance of the 2021 Term Loans and the 2029 Senior Notes, as defined below.

During current year, Novelis has made ₹ 4,668 crore (\$ 615 million) in principal payments beyond its scheduled quarterly amortization payments on its 2017 Term Loans, a portion of which was paid using cash on hand, the proceeds of our short-term loan due November 30, 2022 Novelis entered into in January 2022, and the April 2021 proceeds from its

2021 Term Loans, as defined below. As a result of such payments, the Group has recorded a loss on extinguishment of debt of ₹ 18 crore (\$ 2.3 million) during current year. As of March 31, 2022, the 2017 Term Loans have been fully repaid.

### 2020 Term Loans:

In April 2020, Novelis Acquisitions LLC borrowed ₹ 5,892 crore (\$ 775 million) under the Novelis' existing secured term loan credit agreement ("Term Loan Facility") prior to its merger into Aleris Corporation. The proceeds of the incremental term loans were used to pay a portion of the consideration payable in the acquisition of Aleris (including the repayment of Aleris' outstanding indebtedness) as well as fees and expenses related to the acquisition, and the incremental term loans. The incremental term loans will mature on January 21, 2025, subject to 0.25% quarterly amortization payments. The incremental term loans accrue interest at LIBOR (as defined in the Term Loan Facility) plus 1.75%.

As of March 31, 2022, the outstanding amount on 2020 Term Loan Facility is ₹ 5,673 crore (\$ 748 million) net of debt issuance cost of ₹ 82 crore (\$ 11 million).

### 2021 Term Loans:

In March 2021, Novelis borrowed ₹ 3,649 crore (\$ 480 million) of term loans (the "2021 Term Loans") under its Term Loan Facility with an additional ₹ 149 crore (\$ 20 million) being borrowed under the 2021 Term Loans in April 2021. The 2021 Term Loans mature on March 31, 2028 and are subject to 0.25% quarterly amortization payments. The existing loans under the Term Loan Facility accrue interest at LIBOR plus 2%. The proceeds of the 2021 Term Loans were applied to refinance a portion of the 2017 Term Loans.

As of March 31, 2022 the outstanding amount on 2021 Term Loan Facility is ₹ 3,699 crore (\$ 487 million) net of debt issuance cost of ₹ 58 crore (\$ 8 million).

### Zhenjiang Loans

Through the acquisition of Aleris on April 14, 2020, Novelis assumed ₹ 1,078 crore (\$ 142 million) in debt borrowed by Aleris Aluminum (Zhenjiang) Co., Ltd. ("Aleris Zhenjiang") under a loan agreement comprised of non-recourse multi currency secured term loan facilities and a revolving facility (collectively the "Zhenjiang Loans"), which consisted of a ₹ 221 crore (\$ 29 million) U.S. dollar term loan facility, a ₹ 852 crore (\$ 112 million) Renminbi term loan facility (collectively, the "Zhenjiang Term Loans") and a revolving facility (the "Zhenjiang Revolver"). The Zhenjiang Revolver has certain restrictions that have limited Novelis's ability to borrow funds on the Zhenjiang Revolver and will continue to limit Novelis' ability to borrow funds in the future. All borrowings under the Zhenjiang Revolver matured on May 18, 2021.

In May 2021, the Zhenjiang term loans amounting to ₹ 959 crore (\$ 129 million) were prepaid in full. As a result of repayment of term loan the Group recognised gain on extinguishment of debt of ₹ 16 crore (\$ 2 million). As of March 31, 2022, there is no amounts outstanding under the Zhenjiang Revolver.

All the above term loans of Novelis are part of its senior secured credit facilities, which are guaranteed by its direct parent, AV Metals Inc., and certain its direct and indirect subsidiaries and are secured by a pledge of substantially all of the assets, including Intangible Assets but excluding Right-of-Use Assets, of the Novelis and the guarantors.

## (d) Unsecured Senior Notes comprise of following:

### 5.875% Senior Notes due September 2026

In September, 2016, Novelis Corporation, an indirect wholly owned subsidiary of Novelis Inc., issued \$ ₹ 10,972 crore (1.5 billion) in aggregate principal amount of 5.875% Senior Notes Due 2026 (the "2026 Senior Notes"). The proceeds from the August 2021 issuance of the 2026 Senior Notes and the 2031 Senior Notes, as defined below, were used to fully fund the redemption of the 5.875% Senior Notes due September 2026.

As of March 31, 2022, the 2026 Senior Notes were no longer outstanding.



# Notes

forming part of the Consolidated Financial Statements

## 2026 Senior Notes & 2031 Senior Notes

In August 2021, Novelis Corporation, an indirect wholly owned subsidiary of Novelis Inc., issued ₹ 5,563 crore (\$ 750 million) in aggregate principal amount of 3.250% Senior Notes due November 2026 (the "2026 Senior Notes"). The 2026 Senior Notes mature on November 15, 2026 and are subject to semi-annual interest payments that will accrue at a rate of 3.250% per year. The net proceeds of the offering, together with cash on hand, were used to (i) fund the redemption of a portion of the 5.875% Senior Notes due September 2026, plus the redemption premium and accrued and unpaid interest thereon and (ii) pay certain fees and expenses in connection with the foregoing and the offering of the notes.

In August 2021, Novelis Corporation, a wholly owned subsidiary of Novelis Inc., issued ₹ 5,563 crore (\$ 750 million) in aggregate principal amount of 3.875% Senior Notes due August 2031 (the "2031 Senior Notes"). The 2031 Senior Notes mature on August 15, 2031 and are subject to semi-annual interest payments that will accrue at a rate of 3.875% per year. The net proceeds of the offering, together with cash on hand, were used to (i) fund the redemption a portion of the 5.875% Senior Notes due September 2026, plus the redemption premium and accrued and unpaid interest thereon and (ii) pay certain fees and expenses in connection with the foregoing and the offering of the notes.

The Group has incurred debt issuance costs of ₹ 81 crore (\$ 11 million) for the 2026 Senior Notes and 2031 Senior notes, which will be amortized as an increase to interest expense and amortization of debt issuance costs over the term of the note.

As a result of this transaction, the Group has recorded a loss on extinguishment of debt of ₹ 453 crore (\$ 60.9 million) and gain on modification of ₹ 103 crore (\$ 13.9 million) in the second quarter of fiscal 2022, ₹ 378 crore (\$ 51 million) of which related to redemption premium and was paid with cash on hand.

As of March 31, 2022 outstanding amount on 2026 Senior Notes and 2031 Senior Notes is ₹ 5,561 crore (\$ 732 million) respectively.

## 2029 Senior Notes

In March 2021, Novelis Sheet Ingot GmbH, an indirect wholly owned subsidiary of Novelis Inc., organized under the laws of Ireland, issued ₹ 4,299 crore (€ 500 million) in aggregate principal amount 3.375% Senior Notes due 2029 (the "2029 Senior Notes" and together with the 2026 Senior Notes and the 2030 Senior Notes, the "Senior Notes"). The 2029 Senior Notes are subject to semi-annual interest payments and mature on April 15, 2029. The proceeds were used to pay down a portion of the 2017 Term Loans, plus accrued and unpaid interest. In addition, Novelis intend to allocate an amount equal to the net proceeds received from this issuance to finance and/or refinance new and/or existing eligible green projects, which are currently contemplated to consist of renewable energy or pollution prevention and control type projects.

As of March 31, 2022 outstanding amount on 2029 Senior Notes is ₹ 4,143 crore (\$ 546 million) net of debt issuance cost of ₹ 78 crore (\$ 10 million).

## 2030 Senior Notes

In January 2020, Novelis Corporation, an indirect wholly owned subsidiary of Novelis Inc., issued ₹ 11,704 crore (\$ 1.6 billion) in aggregate principal amount of 4.750% Senior Notes due January 2030 (the "2030 Senior Notes"). The 2030 Senior Notes are subject to semi-annual interest payments and mature on January 30, 2030.

As of March 31, 2022 outstanding amount on 2030 Senior Notes is ₹ 11,957 crore (\$ 1.6 billion) net of debt issuance cost of ₹ 188 crore (\$ 25 million).

## (e) Unsecured Foreign Currency Term Loan from Banks comprise of following:

### Bank of China Term Loan

In September 2019, Novelis entered into a credit agreement with the Bank of China to provide up to CNY 500 million in unsecured loans to support previously announced capital expansion projects in China. As of March 31, 2022 the outstanding amount of this loan is ₹ 573 crore (\$ 76 million). This loan carries interest rates of 4.90%.

## Brazil Loans

In the third quarter of fiscal 2022, Novelis borrowed ₹ 223 crore (\$ 30 million) of bank loans. These bank loans are due June 16, 2023 and are subject to 1.8% interest due in full at the maturity date. As of March 31, 2022 the outstanding balance on this loan is ₹ 228 crore (\$ 30 million).

In the third quarter of fiscal 2022, Novelis also borrowed ₹ 149 crore (\$ 20 million) of bank loans due December 15, 2023. These bank loans are subject to 1.8% interest due in full at the maturity date. As of March 31, 2022 the outstanding balance on this loan is ₹ 152 crore (\$ 20 million).

## (f) Deferred Payment Liabilities

On July 23, 2018, Novelis Switzerland, an indirectly wholly owned subsidiary of Novelis Inc. acquired real and personal property from Constellium Valais SA for ₹ 1,855 crore (\$ 249 million). Out of total purchase price, ₹ 25 crore (\$ 3.9 million) is to be paid over a period through July 2023. This facility carries interest rates of 7.5%.

## (g) Changes in Liabilities arising from Financing Activities:

Particulars	Liabilities from financing activities				Total
	Non Current Borrowings	Current Borrowings	Lease Obligations	Supplier's Credit	
<b>Balance as at April 01, 2020 #</b>	<b>59,459</b>	<b>8,762</b>	<b>1,142</b>	<b>-</b>	<b>69,363</b>
Cash Flows (Net)	(2,915)	2,020	(331)	255	(971)
Additions	-	-	385	-	385
Foreign Exchange Adjustments	(1,254)	(126)	38	-	(1,342)
Fair Value Changes - (refer Note 26 (c))	(87)	(30)	-	-	(117)
Debt Issuance Costs and Amortisation (Net)	68	-	-	-	68
Interest Expense **	3,569	252	56	-	3,877
Interest Paid **	(3,581)	(278)	(51)	-	(3,910)
Disposal/Modification/Reassessment	-	-	(135)	-	(135)
Changes in Liabilities Assumed on Acquisition	1,078	-	124	-	1,202
Reclassification	4,484	(4,484)	-	-	-
Other Changes/Reclassification	3	(68)	-	-	(65)
<b>Balance as at March 31, 2021 #</b>	<b>60,824</b>	<b>6,048</b>	<b>1,228</b>	<b>255</b>	<b>68,355</b>
Cash Flows (Net)	(3,747)	(849)	(337)	2,161	(2,772)
Additions	-	-	412	-	412
Foreign Exchange Adjustments	1,198	135	14	40	1,387
Fair Value Changes - (refer Note 26 (c))	(64)	-	-	-	(64)
Debt Issuance Costs and Amortisation (Net)	79	-	-	-	79
Interest Expense **	3,381	202	56	8	3,647
Interest Paid **	(3,127)	(75)	(50)	(8)	(3,260)
Disposal/Modification/Reassessment	-	(4)	(72)	-	(76)
Changes in Liabilities Assumed on Acquisition	-	139	-	-	139
Liabilities on Disposal of a Subsidiary	(6)	(21)	-	-	(27)
Other Changes	(6)	6	-	-	-
<b>Balance as at March 31, 2022 #</b>	<b>58,532</b>	<b>5,581</b>	<b>1,251</b>	<b>2,456</b>	<b>67,820</b>

# Borrowing include Interest accrued on borrowings and current maturities of related borrowings.

\*\* Interest expenses and interest paid relates to borrowings and lease liabilities before interest capitalisation.

# Notes

forming part of the Consolidated Financial Statements

## 18B. Borrowings, Current

Refer Note 1B(Q) for accounting policy on Financial Instruments

Particulars	As at	
	31/03/2022	31/03/2021
(₹ in Crore)		
<b>Secured</b>		
Loans from Banks		
Rupee Loans - (a), (b) & (d)	5	7
Foreign Currency Loans - (g)	114	651
Loans from Others		
Foreign Currency Loans - (c)	4	2
	<b>123</b>	<b>660</b>
<b>Unsecured</b>		
Loans from Banks		
Rupee Loans - (d)	-	40
Foreign Currency Loans - (e), (f)	5,300	5,329
	<b>5,300</b>	<b>5,369</b>
Current Maturities of Long-term Borrowings	6,177	964
	<b>11,600</b>	<b>6,993</b>

- (a) Working Capital loan for Aluminium business, granted under the Consortium Lending Arrangement, are secured by a first pari-passu charge on entire stocks of raw materials, work-in-process, finished goods, consumable stores and spares and also book debts pertaining to the Company's Aluminium business, both present and future. Working Capital loan for the Copper business is secured by a first pari passu charge on stocks of raw materials, work-in-process, finished goods and consumable stores and spares and also book debts and other movable assets of Copper business, both present and future. (Refer Note 11(a))
- (b) Cash Credit facilities for Utkal Alumina International Limited (Utkal) with banks are availed under the consortium lending arrangement and are secured by (a) first pari-passu charge by hypothecation of investments classified as "held for trading", entire stocks of raw materials, semi-finished and finished goods, consumable stores and spares, investments classified as "available for sale", stock-in trade and book debts pertaining to Utkal's business, both present and future and (b) second charge on Utkal's fixed assets. The borrowings carry floating interest rate at MCLR (ranging from 3 months to one year) + Spread (ranging from 25 bps to 55 bps).
- (c) Payable under trade financing arrangements in Novelis Inc.
- (d) Represents loan taken to meet the Company's working capital requirements. The loan carry interest rate of 3.31% p.a.
- (e) Includes ₹ 1,401 crore (31/03/2021: ₹ 4,245 crore) unsecured Foreign currency loans from Indian Banks and Foreign banks, mainly in nature of Buyers credit which has been availed for Copper business to meet its working capital requirement, mostly to settle the import payments of copper concentrate and certain other raw materials. The loan carry interest rate of 6M SOFR. - Refer Note 46B (c) on non-derivative financial instruments used as hedging instruments.
- (f) In January 2022, Novelis entered into a ₹ 2,390 crore (\$ 315 million) short-term loan with Axis Bank Limited, IFSC Banking Unit, Gift City, as administrative agent and lender. The proceeds of the short-term loan were applied to voluntarily prepay the 2017 Term Loans, as defined in Note 18A, Non-current borrowings. The short-term loan matures on November 30, 2022, is subject to 0.25% quarterly amortization payments, and accrues interest at Secured Overnight Financing Rate (SOFR) plus 0.90%. The short-term loan is unsecured and guaranteed by certain of the Group's direct and indirect U.S. and Canadian subsidiaries, and the agreement contains voluntary prepayment provisions, affirmative and negative covenants, and events of default substantially similar to those under Novelis' Term Loan Facility, other than changes to reflect the

unsecured nature of the short-term loan. As at March 31, 2022, the outstanding balance on this borrowing is ₹ 2,374 crore (\$ 313 million).

- (g) Foreign Currency Loans represents amount of ABL Revolver credit facility in Novelis. The loan carry interest rate of 3.75% p.a.

As of March 31, 2022, the revolver had an outstanding balance of ₹ 114 crore (\$ 15 million); and ₹ 1,197 crore (\$ 158 million) was utilized for letters of credit. There was ₹ 10,074 crore (\$ 1.3 billion) in remaining availability, including ₹ 131 crore (\$ 17 million) of remaining availability that can be utilized for letters of credit.

Above credit facility in Novelis is part of its senior secured credit facilities, which are guaranteed by its direct parent, AV Metals Inc., and certain its direct and indirect subsidiaries and are secured by a pledge of substantially all of the assets, including Intangible Assets but excluding Right-of-Use Assets, of the Novelis and the guarantors.

## 19. Supplier's Credit

	As at			
	31/03/2022		31/03/2021	
	Non-Current	Current	Non-Current	Current
Supplier's Credit	-	2,456	-	255
	-	<b>2,456</b>	-	<b>255</b>

- (a) Supplier's Credit represents the extended interest bearing credit offered by the supplier which is secured against Usance Letter of Credit (LC). Under this arrangement, the supplier is eligible to receive payment from negotiating bank prior to the expiry of the extended credit period. The interest for the extended credit period payable to the bank on maturity of the LC has been presented under Finance Cost.

## 20. Trade Payables

Refer Note 1B(P) for accounting policy on Trade and Other Payables

	As at			
	31/03/2022		31/03/2021	
	Non-Current	Current	Non-Current	Current
Micro and Small Enterprises	-	105	-	58
Other than Micro and Small Enterprises - (b) & (c)	-	41,277	-	28,177
	-	<b>41,382</b>	-	<b>28,235</b>

- (a) Trade Payables ageing schedule as at 31/03/2022:

Particulars	Unbilled	Not Due	Outstanding for following periods from due date of payment				Total
			Less than 1 year	1 - 2 years	2 - 3 years	More than 3 years	
(i) MSME	14	33	44	10	3	1	105
(ii) Others	4,074	29,622	7,261	157	22	54	41,190
(iii) Disputed - MSME	-	-	-	-	-	-	-
(iv) Disputed - Others	-	-	21	22	44	-	87
<b>Total</b>	<b>4,088</b>	<b>29,655</b>	<b>7,326</b>	<b>189</b>	<b>69</b>	<b>55</b>	<b>41,382</b>

Trade Payables ageing schedule as at 31/03/2021:



# Notes

forming part of the Consolidated Financial Statements

(₹ in Crore)

Particulars	Unbilled	Not Due	Outstanding for following periods from due date of payment				Total
			Less than 1 year	1 - 2 years	2 - 3 years	More than 3 years	
			(i) MSME	3	12	31	
(ii) Others	2,797	17,380	7,566	30	10	71	27,854
(iii) Disputed - MSME	-	114	63	5	6	6	194
(iv) Disputed - Others	2	-	22	53	12	46	135
<b>Total</b>	<b>2,802</b>	<b>17,506</b>	<b>7,682</b>	<b>93</b>	<b>28</b>	<b>124</b>	<b>28,235</b>

(b) Refer Note 42 for balances with related parties.

(c) Refer Note 46-B(c) on non-derivative financial instruments used as hedging instruments.

## 21. Other Financial Liabilities

Refer Note 1B(Q) for accounting policy on Financial Instruments

### A. Other Financial Liabilities, Non-Current

(₹ in Crore)

	As at	
	31/03/2022	31/03/2021
Liability for Capital Expenditure	8	4
Security and Other Deposits	2	2
Others - (a)	129	127
	<b>139</b>	<b>133</b>

(a) Mainly includes employee liabilities of ₹ 127 crore (31/03/2021: ₹ 120 crore)

### B. Other Financial Liabilities, Current

(₹ in Crore)

	As at	
	31/03/2022	31/03/2021
Derivative Matured, pending settlement	1,444	546
Interest Accrued but not due	878	894
Liability for Capital Expenditure	1,080	953
Security and other Deposits	42	33
Investor Education and Protection Fund		
Unclaimed Dividends - (a)	5	5
Debentures - (b)	3	3
Others	155	97
	<b>3,607</b>	<b>2,531</b>

(a) These amounts do not include any amount, due and outstanding, to be credited to 'Investor Education and Protection Fund' except ₹ 0.09 crore (31/03/2021: ₹ 0.09 crore) which is held in abeyance due to legal cases pending.

(b) In terms of Debenture Subscription Agreement between Utkal Alumina International Limited ('UAIL'), a wholly owned subsidiary of the Group, and Orissa Mining Corporation Limited ('OMCL'), UAIL issued during the year, a Zero Coupon Unsecured Redeemable Non-Convertible Debentures of ₹ 3 crore to OMCL towards its obligation to pay OMCL an amount equivalent to 15% per annum on ₹ 20 crore as return up to March 31, 2022 which is due for redemption at par on September 30, 2022.

## 22. Provisions

Refer Note 1B(L) for accounting policy on Provisions and Contingencies and

Refer Note 1B(V) for accounting policy on Employee Benefits

(₹ in Crore)

Particulars	As at					
	31/03/2022			31/03/2021		
	Non-Current	Current	Total	Non-Current	Current	Total
<b>Employee Benefit Provisions - (refer note 30)</b>	6,187	1,115	7,302	7,472	1,138	8,610
<b>Other Provisions:</b>						
Assets Retirement Obligations	288	5	293	302	78	380
Environmental Liability	89	410	499	14	191	205
Enterprise Social Commitment	139	100	239	200	48	248
Renewable Power Obligation	-	148	148	-	172	172
Legal Cases	-	744	744	-	525	525
Other Miscellaneous Provisions	145	319	464	158	458	616
	<b>661</b>	<b>1,726</b>	<b>2,387</b>	<b>674</b>	<b>1,472</b>	<b>2,146</b>
	<b>6,848</b>	<b>2,841</b>	<b>9,689</b>	<b>8,146</b>	<b>2,610</b>	<b>10,756</b>

(a) The Group have made provisions towards environmental, asset retirement, social responsibility, renewable power, restructuring, rehabilitation, carbon emission, legal and other obligations at various locations involving considerable uncertainties towards amount and timing of outflow of economic resources. The provisions are discounted over the management expected timing of related cash flows.

(b) Movements in each class of Other Provisions are set out below:

(₹ in Crore)

	Assets Retirement Obligations	Environmental Liability	Enterprise Social Commitment	Renewable Power Obligation	Legal Cases	Other Miscellaneous Provisions *	Total
<b>Balance as at April 01, 2020</b>	<b>377</b>	<b>66</b>	<b>243</b>	<b>186</b>	<b>612</b>	<b>513</b>	<b>1,997</b>
Recognised	41	54	5	75	75	337	587
Reclassified	-	-	-	-	1	-	1
Used/Paid	(32)	(12)	(13)	(31)	(68)	(192)	(348)
Reversed	(1)	-	(1)	(58)	(79)	(112)	(251)
Unwinding of discounts	3	1	14	-	-	-	18
Exchange adjustment	(8)	(6)	-	-	(16)	(34)	(64)
Additions due to acquisition	-	102	-	-	-	104	206
Other	-	-	-	-	-	-	-
<b>Balance as at March 31, 2021</b>	<b>380</b>	<b>205</b>	<b>248</b>	<b>172</b>	<b>525</b>	<b>616</b>	<b>2,146</b>

# Notes

forming part of the Consolidated Financial Statements

(₹ in Crore)

	Assets Retirement Obligations	Environmental Liability	Enterprise Social Commitment	Renewable Power Obligation	Legal Cases	Other Miscellaneous Provisions *	Total
Recognised	7	317	-	112	200	372	1,008
Reclassified	16	-	-	-	-	(16)	-
Used/Paid	(40)	(4)	(23)	(107)	(10)	(493)	(677)
Reversed - (d)	-	(26)	-	(29)	(23)	(49)	(127)
Unwinding of discounts	16	1	14	-	-	-	31
Exchange adjustment	9	7	-	-	52	34	102
Reversed on disposal of a subsidiary	(95)	(1)	-	-	-	-	(96)
<b>Balance as at March 31, 2022</b>	<b>293</b>	<b>499</b>	<b>239</b>	<b>148</b>	<b>744</b>	<b>464</b>	<b>2,387</b>

\* Other Provisions primarily includes provisions towards restructuring, rehabilitation, carbon emission, statutory provisions related to indirect taxes, coal cess, etc.

## (c) Brief Description of Provisions:

### i) Assets Retirement Obligations:

Asset Retirement Obligation (ARO) is a legal or constructive obligation associated with the ash ponds, red mud ponds, ash pipeline and coal transportation system in refineries and mining land where the land needs to be restored back to usable condition after closing of activities. This is a statutory requirement in which the timing or method of settlement may be conditional on one or multiple future events, the occurrence of which may not be within the control of the entity. The outflow of economic resources is expected during FY 2023 to FY 2054. The same has been appropriately discounted.

### ii) Environmental Liability:

Environmental Liability is associated with Wild Life Conservation Plan (WLCP) and disposal of hazardous material generated during the course of manufacturing or mining operation e.g. disposal of spent pot lining, Gypsum, Slag etc. This disposal generally takes place as per the guidelines set by various regulatory authorities of States and Central Government. The outflow of economic resources is generally expected in following financial year during FY 23 to FY 31.

### iii) Enterprise Social Commitment:

Enterprise Social Commitment is the amount to be spent on social and economic development of the surrounding area where new project is being setup. This is generally defined as a certain percentage of the total cost of the project. The outflow of economic resources is expected during FY 2023 to FY 2056. This has been appropriately discounted wherever necessary.

### iv) Renewable Power Obligation (RPO):

Some of our units situated in various states like Odisha, Madhya Pradesh, Maharashtra, Gujarat, Jharkhand etc. who gets power from Captive power plants or procure power from open source, are obligated to purchase certain portion of their power consumption from Renewable Energy sources, both solar and non-solar. This gives rise to Renewable Power Obligation (RPO). In case the obligated units fail to procure power from such renewable sources, they may satisfy the obligation by purchasing Renewable Energy Certificates from authorised exchanges as an alternative.

### v) Legal Cases:

There are certain legal cases (including revenue matters) against which provision has been made since these events are probable to happen i.e. more likely than not but timing of occurrence of such events is uncertain as it depends on when the matter will be settled at the highest Court of law.

### vi) Other Miscellaneous Provisions:

Restructuring charges include employee severance and benefit costs and other costs associated with exit activities. Severance costs are recognized when management with the proper level of authority has committed to a restructuring plan and communicated those actions to employees. Other exit costs include environmental remediation costs and contract termination costs, primarily related to equipment and facility lease obligations. At each reporting date, we evaluate the provisions for restructuring costs to ensure the provisions are still appropriate.

Provision for carbon emission represents estimated liabilities towards emissions for operations in Europe and Asia. The provision is measured at the carrying amount of allowances to the extent that the provision will be settled using allowances on hand, with any excess emission being measured at the market value of the allowances at the period end.

We believe we have made reasonable estimates for the costs that are reasonably possible for these provisions.

Based on the estimates of the timing of the cash outflows related to provisions, discounting will not have a material impact.

### (d) Reversal of Provisions:

#### Reversal of RPO Provision

Pursuant to the issuance of notification by Madhya Pradesh Electricity Regulatory Commission (MPERC) in India, the Group has reversed the excess RPO provision of ₹ 13 crore related to FY 2021 in current year and during previous year pursuant to the issuance of notification by MPERC, dated April 05, 2021, the Group has reversed the excess RPO provision of ₹ 21 crore related to FY 2020. Additionally ₹ 36 crore has been reversed on account of reduction in Solar certificate rate from ₹ 2,400/REC to ₹ 1,000/REC.

#### Reversal of Legal Cases Provision

During previous year reversal of ₹ 39 crore includes reversal of ₹ 37 crore on account of UP Transit Fees and ₹ 2 crore on account of Energy Compensation Charges.

## 23. Other Non-Current and Current Liabilities

(₹ in Crore)

	As at			
	31/03/2022		31/03/2021	
	Non-Current	Current	Non-Current	Current
Customer Refund Liability - (a)	-	205	-	128
Statutory Dues Payables	88	1,418	156	1,154
Deferred Income - (b) & (c)	1,769	229	1,349	83
Other Payables	31	21	34	21
	<b>1,888</b>	<b>1,873</b>	<b>1,539</b>	<b>1,386</b>

(a) Customer refund liability are recognised mainly for discount payable to customers.

(b) Includes deferred income in respect of grant related to Export Promotion Capital Goods (EPCG) ₹ 600 crore (31/03/2021: ₹ 609 crore) in non-current portion and ₹ 20 crore (31/03/2021: ₹ 20 crore) in current portion.

(c) Includes deferred government grant income of ₹ 1,169 crore (31/03/2021: ₹ 740 crore) in non-current portion and ₹ 209 crore (31/03/2021: ₹ 58 crore) in current portion.



# Notes

forming part of the Consolidated Financial Statements

## 24. Contract Liabilities

Refer Note 1B(Z) for accounting policy on Contract Liability

Particulars	As at					
	31/03/2022			31/03/2021		
	Non-Current	Current	Total	Non-Current	Current	Total
Advance from Customers	10	365	375	12	347	359
	10	365	375	12	347	359

(a) Reconciliation of contract liabilities for the periods presented:

	As at	
	31/03/2022	31/03/2021
Balance at beginning of the year	359	202
Amount received during the year against which revenue has not been recognized	193	304
Additions due to Aleris Acquisition	-	8
Revenue recognized during the year		
Less: Contract liabilities at the beginning of the year	(182)	(152)
Foreign exchange gains and losses	5	(3)
<b>Balance at end of the year</b>	<b>375</b>	<b>359</b>

## 25. Revenue from Operations

Refer Note 1B(Y) for accounting policy on Revenue Recognition

Refer Note 1B(U) for accounting policy on Accounting for Government Grants

	Year ended	
	31/03/2022	31/03/2021
<b>Revenue from Contract with Customers</b>		
Sale of Products - (a)	191,314	128,619
Trade Sales - (b)	1,177	1,414
Sale of Services - (c)	1,265	976
	193,756	131,009
<b>Other Operating Revenues - (a) &amp; (d)</b>	<b>1,303</b>	<b>999</b>
	<b>195,059</b>	<b>132,008</b>
<b>Reconciliation of revenue recognised with contract price:</b>		
<b>Contract Price</b>	<b>202,622</b>	<b>133,248</b>
Adjustments for:		
Refund Liabilities and Discounts	(1,527)	(1,266)
Hedging Gain/ (Loss)	(7,219)	(881)
Others - Provisionally priced contracts	(120)	(92)
<b>Revenue from Contracts with Customers</b>	<b>193,756</b>	<b>131,009</b>

- (a) Sales of Copper products and precious metals are accounted for provisionally, pending finalization of price and quantity. Variations are accounted for in the period of settlement. Final price receivable on sale of above products for which provisional price was not finalized are realigned at year end forward LME/LMBA rate and is being presented as part of other operating revenue. Revenue from subsequent variation in price movement is loss of ₹ 24 crore (31/03/2021: loss of ₹ 31 crore).
- (b) Includes nutrient based subsidy of Phosphorus (P) & Potassium (K) arising from sale of Di ammonium phosphate (DAP) ₹ 441 crore (31/03/2021: ₹ 402 crore).
- (c) Sale of Services predominantly includes freight and insurance on certain export contracts, which are identified as separate performance obligation under Ind AS 115.
- (d) Includes Government grant in the nature of sales related export incentives and other benefits of ₹ 414 crore (31/03/2021: ₹ 211 crore).
- (e) Group's revenue from external customers as analysed by the country, in which customers are located is given below:

	Year ended	
	31/03/2022	31/03/2021
<b>India</b>	46,139	28,686
<b>Outside India</b>		
United States	46,623	31,083
Brazil	18,347	13,206
Korea	12,418	9,009
United Kingdom	7,305	6,161
Germany	6,060	5,317
China	10,631	5,815
Others	47,122	32,520
	<b>194,645</b>	<b>131,797</b>
Add: Export Incentive and other benefits	414	211
<b>Total Revenue from Operations</b>	<b>195,059</b>	<b>132,008</b>

- (f) Applying the practical expedient as given in Ind AS 115, the Group has not disclosed the remaining performance obligations related disclosures for contracts where revenue recognized corresponds directly with value to the customer of the Group's performance completed to date.

## Notes

forming part of the Consolidated Financial Statements

### 26. Other Income

Refer Note 1B(AA) for accounting policy on Dividend and Interest Income

Refer Note 1B(U) for accounting policy on Accounting for Government Grants

Refer Note 1B(Q) for accounting policy on Financial Instruments

	(₹ in Crore)	
	Year ended	
	31/03/2022	31/03/2021
Interest Income		
On Non-Current Investments	20	13
On Current Investments	35	24
On Others	170	144
Dividend Income		
On Non-Current Investments - (a)	32	25
Rent Income	20	16
Gains/ (Loss) on Property, Plant and Equipment and Intangibles Assets sold/ discarded (Net)	(100)	(35)
Gains/(Loss) on Financial Investments Measured at FVTPL (Net)		
On sale of Financial Assets	349	809
On change of Fair Value of Financial Assets	10	(266)
Income from Government Grants - (b)	275	141
Other Non-Operating Income (Net) - (c), (d)	325	328
	<b>1,136</b>	<b>1,199</b>

- (a) All dividends from equity investments designated at FVTOCI relate to investments held at the end of the reporting period. Dividend income of ₹ 1 crore (31/03/2021: ₹ Nil) relating to investments derecognised during the reporting period.
- (b) Grant income mainly includes carbon emission credit allotments of ₹ 255 crore (31/03/2021: ₹ 116 crore) for certain operations in Europe, UK and Asia and grant income associated with fixed assets investments in North America, South America, Europe and Asia of Group's subsidiary, Novelis Inc. There are no unfulfilled conditions or other contingencies attached to these grants.
- (c) Includes gain on repayment and modification of borrowings ₹ 183 crore (31/03/2021: ₹ 113 crore) resulting from change in rate and timing of expected cash flows payments on term loans. It also includes gain recognised on account of change in loan amortisation schedule ₹ Nil (31/03/2021: ₹ 4 crore) due to change in benchmark rate.
- (d) Includes royalty income of ₹ 7 crore (31/03/2021: ₹ 58 crore).

### 27. Cost of Materials Consumed

	(₹ in Crore)	
	Year ended	
	31/03/2022	31/03/2021
Raw Materials - (a)	125,335	77,484
	<b>125,335</b>	<b>77,484</b>

- (a) Purchase of copper concentrate is accounted for provisionally pending finalization of contents in the concentrate and price. Variations are accounted for in the period of settlement. Final price payable on purchase of copper concentrate for which provisional price and quantity were not finalized during the year are realigned based on forward LME and LBMA rate. Impact on cost from subsequent variation in price movement was loss of ₹ 922 crore (31/03/2021: gain of ₹ 160 crore).

### 28. Trade Purchases

	(₹ in Crore)	
	Year ended	
	31/03/2022	31/03/2021
Aluminum Rolled Product	256	126
Fertilizer - (a)	1,530	928
Others	172	44
	<b>1,958</b>	<b>1,098</b>

- (a) During the previous year, the Fertilizer plant at Dahej, Gujarat was shut for regular maintenance and during the current year, The Group has discontinued and impaired the Fertilizer plant. Thus, for both years, to cater to the domestic demand, the Group has imported the fertilizer products i.e. Di Ammonium Phosphate (DAP) and Nitrogen, Phosphorus and Potassium (NPK).

### 29. Changes in Inventories of Finished Goods, Work-in-Progress and Stock-in-Trade

	(₹ in Crore)					
	Opening Inventories		Closing Inventories		Net Change	
	As at		As at		Year ended	
	01/04/2021	01/04/2020	31/03/2022	31/03/2021	31/03/2022	31/03/2021
Work-in-Progress	13,439	10,102	20,434	13,439	(6,995)	(3,337)
Finished Goods	4,869	4,500	7,180	4,869	(2,311)	(369)
Stock-in-Trade	4	127	884	4	(880)	123
	<b>18,312</b>	<b>14,729</b>	<b>28,498</b>	<b>18,312</b>	<b>(10,186)</b>	<b>(3,583)</b>
Inventories acquired in business combination - (refer Note 49)	-	-	-	-	9	1,755
Inventories on disposal of a subsidiary	-	-	-	-	(77)	-
Currency Translation Adjustment (Net)	-	-	-	-	501	(318)
	<b>18,312</b>	<b>14,729</b>	<b>28,498</b>	<b>18,312</b>	<b>(9,753)</b>	<b>(2,146)</b>



# Notes

forming part of the Consolidated Financial Statements

## 30. Employee Benefits

### (A) Employee Benefits Expense

Refer Note 1B(V) for accounting policy on Employee Benefits

Refer Note 1B(W) for accounting policy on Employee Share-based Payments

	(₹ in Crore)	
	Year ended	
	31/03/2022	31/03/2021
Salaries and Wages	9,073	8,274
Post Employment Benefits:		
Contribution to Provident Fund and Other Defined Contribution Funds	417	421
Gratuity and Other Defined Benefit Plans	410	356
Employee Share-Based Payment (refer Note 41)		
Equity Settled Share-Based Payment	35	15
Cash-Settled Share-Based Payment	307	286
Employee Welfare Expenses	1,754	1,567
	<b>11,996</b>	<b>10,919</b>
Less: Transferred to Capital Work-in-Progress/ Intangible Assets under development	(60)	(137)
	<b>11,936</b>	<b>10,782</b>

- (a) The Code on Social Security, 2020 ('Code') relating to employee benefits during employment and post employment benefits received Presidential assent in September 2020. The Code has been published in the Gazette of India. However, the date on which the Code will come into effect has not been notified. The Group will assess the impact of the Code when it comes into effect and will record any related impact in the period the Code becomes effective.
- (b) The Hon'ble Supreme Court of India by their order dated February 28, 2019, in the case of Surya Roshani Limited v/s EPFO, set out the principles based on which allowances paid to the employees should be identified for inclusion in basic wages for the purposes of computation of Provident Fund contribution. The Group has given effect of the above judgement effective March 1, 2019. This does not have any material impact on the Consolidated Financial Statements.

### (B) Post Employment Benefits

#### 1. Defined Benefit Plans

Major Post retiral defined benefit plans of the Group include Gratuity, Pension, Post retirement medical benefit and Provident Fund (to the extent of the Group's obligation to fund any shortfall on the yield of the trust's investments over the administered interest rates on an annual basis by Central Provident Fund Organisation of Government of India). The Group does Actuarial valuation for its identified long term and short term defined benefit plans.

#### Methodology for actuarial valuation of Defined Benefit Obligations:

The Projected Unit Credit (PUC) actuarial method has been used to assess the plan's liabilities, including those related to death-in-service and incapacity benefits.

Under PUC method a projected accrued benefit is calculated at the beginning of the year and again at the end of the year, for each benefit that will accrue for all active members of the plan. The projected accrued benefit is based on the plan's accrual formula and upon service as of the beginning or end of the year, but using a member's final compensation, projected to the age at which the employee is assumed to leave active service. The plan liability is the actuarial present value of the projected accrued benefits for active members.

Defined benefit plans expose the Group to actuarial risks such as Interest Rate Risk, Salary Risk and Demographic Risk.

- i. Interest Rate Risk: While calculating the defined benefit obligation a discount rate based on government bonds yields of matching tenure is used to arrive at the present value of future obligations. If the bond yield falls, the defined benefit obligation will tend to increase and plan assets will decrease.
- ii. Salary Risk: Higher than expected increases in salary will increase the defined benefit obligation.
- iii. Demographic Risk: This is the risk of variability of results due to unsystematic nature of decrements that include mortality, withdrawal, disability and retirement. The effect of these decrements on the defined benefit obligations is not straight forward and depends on the combination of salary increase, discount rate and vesting criteria. It is important not to overstate withdrawals because in the financial analysis the retirement benefit of a short career employee typically costs less per year as compared to a long service employee.

#### (I) Gratuity Plans

The Group has various schemes (funded/unfunded) for payment of gratuity to all eligible employees calculated at specified number of days (ranging from 15 days to 1 month) of last drawn salary depending upon the tenure of service for each year of completed service subject to minimum service of five years payable at the time of separation upon superannuation or on exit otherwise. These defined benefit gratuity plans are governed by Payment of Gratuity Act, 1972.

	(₹ in Crore)	
	Year ended	
	31/03/2022	31/03/2021
<b>(a) Change in Defined Benefit Obligation (DBO)</b>		
Defined Benefit Obligation at beginning of the year	1,131	1,107
Current Service cost	48	52
Interest Cost on the DBO	68	73
Settlement cost/ (credit)	-	4
Acquisitions (credit)/ cost - (refer note 49)	2	-
Actuarial (gain)/ loss experience	24	(52)
Actuarial (gain)/ loss financial assumption	(69)	23
Benefits paid directly by the Group	(47)	(44)
Benefits paid from plan assets	(27)	(32)
<b>Defined Benefit Obligation at the end of the year</b>	<b>1,130</b>	<b>1,131</b>
<b>(b) Change in Fair Value of Plan Assets</b>		
Fair value of assets at the beginning of the year	998	894
Interest Income on plan assets	63	59
Employer's contributions	56	55
Return on plan assets greater/(lesser) than discount rate	42	22
Benefits Paid	(27)	(32)
<b>Fair value of assets at the end of the year</b>	<b>1,132</b>	<b>998</b>

# Notes

forming part of the Consolidated Financial Statements

(₹ in Crore)

	Year ended	
	31/03/2022	31/03/2021
<b>(c) Development of Net Balance Sheet Position</b>		
Defined Benefit Obligation, Funded	(1,130)	(1,131)
Fair Value of Plan Assets	1,132	998
<b>Funded Status (surplus/(deficit))</b>	<b>2</b>	<b>(133)</b>
Funded surplus not recognised - (refer note - n)	(105)	-
Defined Benefit Obligation, Unfunded	-	-
<b>Net defined benefit asset/(liability)</b>	<b>(103)</b>	<b>(133)</b>
<b>(d) Reconciliation of Net Balance Sheet Position</b>		
Net Defined benefit asset/(Liability)at beginning of the year	(133)	(213)
Service cost	(48)	(52)
Settlement cost/ (credit) <sup>5</sup>	-	(4)
Net Interest on net defined benefit liability/(asset)	(5)	(14)
Amount recognised in OCI	87	51
Funded surplus not recognised - (refer note - n)	(105)	-
Employer's contributions	56	55
Benefit paid directly by Company	47	44
Acquisitions (credit)/ cost	(2)	-
<b>Net Defined benefit asset/(Liability)at the end of the year</b>	<b>(103)</b>	<b>(133)</b>
<b>(e) Expense recognised during the year</b>		
Current Service cost	48	52
Settlement cost/ (credit) <sup>5</sup>	-	4
Net Interest on net defined benefit liability/(asset)	5	14
<b>Net Gratuity Cost</b>	<b>53</b>	<b>70</b>
<b>(f) Other Comprehensive Income (OCI)</b>		
Actuarial (gain)/loss due to DBO experience	24	(52)
Actuarial (gain)/loss due to DBO assumption changes	(69)	23
<b>Actuarial (gain)/loss arising during the year</b>	<b>(45)</b>	<b>(29)</b>
Return on Plan Assets(greater)/less than discount rate	(42)	(22)
Funded surplus not recognised - (refer note - n)	105	-
<b>Actuarial (gain)/loss recognised in OCI</b>	<b>18</b>	<b>(51)</b>

<sup>5</sup> Settlement cost/(credit) during the year has been accounted under Exceptional Expenses as it pertains to Voluntary Retirement Scheme (VRS) granted at our Mines, Gare Palma (refer note - 37)

(₹ in Crore)

	Year ended	
	31/03/2022	31/03/2021
<b>(g) Defined Benefit Cost</b>		
Service Cost	48	56
Net Interest on net defined benefit liability/(asset)	5	14
Actuarial (gain)/loss recognised in OCI	(87)	(51)
<b>Defined Benefit Cost</b>	<b>(34)</b>	<b>19</b>
<b>(h) Principal Actuarial Assumptions</b>		
Discount rate (based on the market yields available on Government bonds at the accounting date with a term that matches that of the liabilities)	7.00%	6.25%
Salary escalation rate	7.50%	7.50%
Weighted average duration of the defined benefit obligation	8 Years	9 Years
Mortality Rate	Indian Assured Lives Mortality 2006-08	
<b>(i) Non-Current and Current portion of Defined Benefit Obligation/(Asset)</b>		
	(₹ in Crore)	
	As at	
	31/03/2022	31/03/2021
Current portion	5	3
Non-Current portion	98	130
	<b>103</b>	<b>133</b>
<b>(j) Sensitivity Analysis</b>		
Sensitivity analysis are based on a change in an assumption while holding all other assumptions constant. In practice, this is unlikely to occur, and changes in some of the assumptions may be correlated. When calculating the sensitivity of the defined benefit obligation to significant actuarial assumptions the same method (present value of the defined benefit obligation calculated with the projected unit credit method at the end of the reporting period) has been applied as when calculating the defined benefit liability recognised in the balance sheet.		
	(₹ in Crore)	
	Year ended	
	31/03/2022	31/03/2021
<b>Discount Rate</b>		
Discount rate as at end of the year	7.00%	6.25%
Effect on Defined Benefit Obligation due to 1% Increase in Discount Rate	(82)	(87)
Effect on Defined Benefit Obligation due to 1% Decrease in Discount Rate	94	100
<b>Salary Escalation Rate</b>		
Salary Escalation Rate as at end of the year	7.50%	7.50%
Effect on Defined Benefit Obligation due to 1% Increase in Salary Escalation Rate	92	98
Effect on Defined Benefit Obligation due to 1% Decrease in Salary Escalation Rate	(82)	(87)



# Notes

forming part of the Consolidated Financial Statements

(₹ in Crore)

	As at	
	31/03/2022	31/03/2021
<b>(k) The Expected Maturity Analysis of Undiscounted Gratuity is as follows:</b>		
Within 1 year	67	58
from 1 year to 2 Year	101	89
from 2 year to 3 Year	104	98
from 3 year to 4 Year	108	96
from 4 year to 5 Year	113	105
from 5 year to 10 Year	628	587

## (l) Plan Assets Information

(₹ in Crore)

Major categories of Plan Assets are as under: *	As at	
	31/03/2022	31/03/2021
Cash and Bank Balances	8.96%	8.96%
Scheme of insurance - conventional product	1.19%	1.19%
Scheme of insurance - ULIP Product	89.85%	89.85%
	<b>100.00%</b>	<b>100.00%</b>

\* Investment in Plan assets are unquoted.

- (m) Expected Contributions to post employment benefit plan of Gratuity for the year ended March 31, 2023: ₹ 70 crore.
- (n) The Group has not recognised the surplus in its plan assets of gratuity fund since no future economic benefits are expected in the form of reduction in future contributions to the gratuity plan or refund from the gratuity plan.

## (II) Pension and Post Employment Medical Benefits of Novelis Inc, the Group's overseas subsidiary

Obligations related to the Group's overseas operations, relate to: (1) funded defined benefit pension plans in the U.S., Canada, Switzerland, and the U.K.; (2) unfunded defined benefit pension plans in Germany; (3) unfunded lump sum indemnities payable upon retirement to employees in France, Malaysia and Italy; and (4) partially funded lump sum indemnities in South Korea. These defined benefit plans provide a benefit to eligible employees based on plan provisions, including but not limited to, years of service, compensation, or other vesting criteria. Each of the funded pension plans is governed by an Investment Fiduciary. Other post retirement obligations include unfunded health care and life insurance benefits provided to eligible retired employees in the U.S., Canada, and Brazil. In addition, it provide post employment benefits, including disability, early retirement and continuation of benefits (medical, dental, and life insurance) to eligible former employees.

In connection with the acquisition of Aleris Corporation, the Group acquired postretirement benefit plans covering certain employees in Europe and the United States. Upon acquisition, the Group recognized the funded status of the defined benefit plans as an asset or a liability within other non-current assets or other non-current liabilities in the consolidated balance sheet. The plan assets are recognized at fair value. The group uses various assumptions when computing amounts relating to its defined benefit pension plan obligations and their associated expenses (including the discount rate and the expected rate of return on plan assets).

Compensated absence is presented as current, since the Group does not have an unconditional right to defer settlement for any of these obligations.

in Crore)

	Year ended	
	31/03/2022	31/03/2021
<b>(a) Change in obligation over the year</b>		
Present Value of defined benefit obligations at the beginning of the year	17,770	16,211
Exchange (gain)/loss on translation	279	212
Current Service Cost	338	439
Interest Cost	406	414
Curtailement cost/ (credit)	(31)	(312)
Plan Settlements	(354)	-
Plans assets on acquisitions	-	1,650
Plan Participants Contribution	38	37
Plan Amendments	(76)	8
Net actuarial (gain)/ loss	(1,328)	(146)
Remeasurement changes in Asset ceiling	28	34
Benefits Paid	(783)	(777)
<b>Present Value of defined obligations at the end of the year</b>	<b>16,287</b>	<b>17,770</b>

## b. Change in plan Assets (Reconciliation of opening and closing Balance)

Fair Value of plan Assets at the beginning of the year	10,732	9,027
Exchange gain/ (loss) on translation	346	107
Plans assumed on acquisitions	-	244
Plan Settlements	(354)	-
Remeasurement - return on plan assets excluding amount included in interest income	(217)	1,114
Interest Income	287	258
Employers' Contributions	633	722
Plan participants contribution	38	37
Benefits Paid	(783)	(777)
<b>Fair value of assets at the end of the year</b>	<b>10,682</b>	<b>10,732</b>

## c. Reconciliation of fair value of assets & obligations

Present value of defined benefit obligations at the end of the year	16,287	17,770
Fair Value of Plan assets at the end of the year	10,682	10,732
<b>Amount recognized in the consolidated balance sheet</b>	<b>5,605</b>	<b>7,038</b>
Recognized prepaid pension	208	81
Recognized pension liability	5,813	7,119

# Notes

forming part of the Consolidated Financial Statements

(₹ in Crore)

	Year ended	
	31/03/2022	31/03/2021
<b>d. Expenses recognized during the year</b>		
Current service cost	338	439
Past service cost/ Curtailment (credit)/ Settlement (gain)	(107)	(305)
Interest cost (net)	119	156
	<b>350</b>	<b>290</b>

### Details of special events during the year:

#### Pension Plan Freeze:

During current year, Novelis announced the freeze of future benefit accruals under the Canada Pension Plan, effective for union participants as of December 31, 2021 and non-union participants as of December 31, 2023. The Group remeasured the plan's assets and obligations as of April 30, 2021, which was the nearest calendar month-end to the announcement of this freeze. A curtailment gain of ₹ 24 crore (USD 3 million) was recorded in the statement of profit and loss for the year ended March 31, 2022.

#### Others:

During current year, Novelis entered into an agreement to transfer the liabilities associated with a portion of the retirees and beneficiaries of the Canada Novelis Pension Plan to an insurer through a purchase of buy-out annuities. The premium payment was made to the insurer on August 10, 2021. The Group remeasured the plan's assets and obligations as of July 31, 2021, which was the nearest calendar month-end to the premium payment for this settlement. As a result of this transaction, a settlement gain of ₹ 7 crore (USD 1 million) was recorded for the year ended March 31, 2022.

The Group recognised past service credit comprising plan amendment mentioned in the table above amounting to ₹ 49 crore (USD 7 million) with respect to plans in North America and ₹ 27 crore (USD 4 million) with respect to plans in Europe during the year ended March 31, 2022 within Employee benefits expense in the profit and loss statement.

### e. Remeasurement of net defined benefit liability/(asset) (OCI)

(₹ in Crore)

	Year ended	
	31/03/2022	31/03/2021
Actuarial (gains)/ losses arising from changes in demographic assumptions	(8)	(77)
Actuarial (gains)/ losses arising from changes in financial assumptions	(1,449)	74
Actuarial (gains)/ losses arising from changes in experience adjustments	129	(143)
<b>Remeasurement of net defined benefit liability</b>	<b>(1,328)</b>	<b>(146)</b>
Remeasurement return on plan assets excluding amount included in interest income	217	(1,114)
Impact of asset ceiling	28	34
Exchange Gain/ (Loss)	(93)	103
	<b>(1,176)</b>	<b>(1,123)</b>

(₹ in Crore)

	Year ended	
	31/03/2022	31/03/2021
<b>f. Composition of Plan Assets</b>		
Equity	2,803	3,520
Fixed Income	6,365	5,792
Real Estate	382	265
Cash and cash equivalent	930	816
Other	202	339
	<b>10,682</b>	<b>10,732</b>

### g. Sensitivity analysis for each significant actuarial assumption

(₹ in Crore)

	31/03/2022		31/03/2021	
	Approximate (increase)/ decrease		Approximate (increase)/ decrease	
	Defined Benefits obligation	Post Employment Medical Benefits	Defined Benefits obligation	Post Employment Medical Benefits
<b>Discount Rate</b>				
Increase of 1 percentage	1,997	71	2,331	85
Decrease of 1 percentage	(2,397)	(84)	(2,834)	(101)
<b>Salary Growth Rate</b>				
Increase of 1 percentage	(279)	-	(349)	-
Decrease of 1 percentage	254	-	308	-
<b>Pension Growth Rate</b>				
Increase of 1 percentage	(679)	-	(831)	-
Decrease of 1 percentage	604	-	714	-
<b>Expected future lifetimes(in years) for employees</b>				
Participants assumed to have the mortality rates of individuals who are one year older	(325)	(8)	(363)	(4)
Participants assumed to have the mortality rates of individuals who are one year younger	331	8	376	4
<b>Medical cost trend rates</b>				
Increase of 1 percentage	-	(105)	-	(105)
Decrease of 1 percentage	-	82	-	105

The above sensitivity analyses are based on a change in an assumption while holding all other assumptions constant. In practice, this is unlikely to occur, and changes in some of the assumptions may be correlated. When calculating the sensitivity of the defined benefit obligation to significant actuarial assumptions the same method (present value of the defined benefit obligation calculated with the projected unit credit method at the end of the reporting period) has been applied as when calculating the defined benefit liability recognised in the balance sheet.



# Notes

forming part of the Consolidated Financial Statements

The methods and types of assumptions used in preparing the sensitivity analysis did not change compared to the prior year.

h. The principal actuarial assumptions at the reporting dates (expressed as weighted averages) for defined benefit plans

Major categories of Plan Assets are as under: *	As at	
	31/03/2022	31/03/2021
Discount Rate	1.42% - 4.01%	0.77% - 3.39%
Salary growth Rate	2.65% - 3.50%	2.60% - 3.50%
Expected future lifetimes (in years) for employees		
Pensioners	23	17
Current employees	6 - 11	8 - 11

i. The principal actuarial assumptions at the reporting dates (expressed as weighted averages) for post employment medical benefits

	As at	
	31/03/2022	31/03/2021
Long term increase in health costs	4.29% - 5%	4.29% - 4.88%
Discount rate	2.70% - 8.90%	2.20% - 8.30%

j. Weighted average duration of the defined benefit obligation in years

	As at	
	31/03/2022	31/03/2021
Weighted average duration of the defined benefit obligation in years	8 - 15	8 - 15

k. Expected maturity analysis of undiscounted defined benefit plan and post-employment medical benefit plans  
(₹ in Crore)

	31/03/2022				31/03/2021			
	Within 1 year	Between 1-2 years	Between 2-5 years	5 to 10 years	Within 1 year	Between 1-2 years	Between 2-5 years	5 to 10 years
Defined benefit plan	743	1,642	2,485	4,532	714	1,547	2,339	4,255
Post employment medical benefit plant	33	83	141	277	36	87	149	298

l. Expected contributions to the defined benefit plans for the year ended March 31, 2023: ₹ 137 crore.

## 2. Other Defined Benefit and contribution Plans

### (A) Other Defined Benefit Plans

#### (a) Post Retirement Medical Benefit

The Group provides post retirement medical benefit to its certain retired employees in India. The scheme involves reimbursement of expenses towards medical treatment of self and dependents. The amount charged to the Consolidated Statement of Profit and Loss during the year is ₹ 0.32 crore (31/03/2021: ₹ 0.34 crore) and amount of actuarial (gain)/ loss recognised in Other Comprehensive Income during the year is ₹ (4) crore (previous year: ₹ (1) crore). The obligation with respect to said scheme as at 31/03/2022 is ₹ 5 crore (year ended 31/03/2021: ₹ 5 crore).

#### (b) Other Pension Plan

It is a pension benefit provided to erstwhile Managing Director. The amount charged to statement of Profit and Loss during the year is ₹ 3 crore (31/03/2021: ₹ 3 crore). Amount of actuarial (gain)/ loss recognised in Other Comprehensive Income during the year is ₹ Nil (31/03/2021: ₹ 1 crore).

The obligation with respect to these schemes as at 31/03/2022: ₹ 47 crore (31/03/2021: ₹ 46 crore).

### (B) Defined Contribution Plans

#### (a) Pension

The Group contributes a certain percentage of salary for all eligible employees in India in the managerial cadre towards Superannuation Funds with option to put certain portion in National Pension Scheme (NPS) and/or in funds managed by Birla Sunlife Insurance Company to be converted to annuity of Life Insurance Corporation of India. Junior Pension Plan provided to certain employees is in the nature of defined benefit plan which provides an annuity in the form of pension amount at retirement. The amount charged to the Consolidated Statement of Profit and Loss during the year is ₹ 16 crore (31/03/2021: ₹ 15 crore) and amount of actuarial gain/ (loss) recognised in Other Comprehensive Income during the year is ₹ Nil (31/03/2021: ₹ 1 crore).

#### (b) Provident Fund

The Company's and certain Indian subsidiaries contribution towards Provident Fund managed either by approved trusts or by the Central Government is debited to the Consolidated Statement of Profit and Loss. In respect of provident fund management by the approved trust, these entities have an obligation to fund any shortfall on the yield of the trust's investments over the administered interest rates on an annual basis. These entities also contributes to Coal Mines Provident Fund (CMPF) in respect of employees working in coal mines.

The amount debited to the Consolidated Statement of Profit and Loss during the year was ₹ 104 crore (31/03/2021: ₹ 103 crore).

Based on actuarial valuation considering this to be in the nature of a defined benefit plan, the Group has recognised obligation as at 31/03/2022 of ₹ Nil (31/03/2021: ₹ 2 crore) towards shortfall on the yield of the trust's investments over the administered interest rates. Amount of actuarial (gain)/ loss recognised in Other Comprehensive Income during the year is ₹ (4) crore (31/03/2021: ₹ (9) crore).

#### Sensitivity Analysis:

	As at	
	31/03/2022	31/03/2021
Provident Fund		
Discount rate		
Effect on DBO due to 1% increase in discount rate	(3)	(3)
Effect on DBO due to 1% decrease in discount rate	4	4
Pension		
Discount rate		
Effect on DBO due to 1% increase in discount rate	(0.01)	(0.1)
Effect on DBO due to 1% decrease in discount rate	0.1	0.1

# Notes

forming part of the Consolidated Financial Statements

## Assumption use in determining the present value obligation of the interest rate guarantee under the Deterministic Approach:

	As at	
	31/03/2022	31/03/2021
Discount rate	7.00%	6.25%
Expected EPFO (Employees' Provident Fund Organisation) Return	8.10%	8.50%

### 3. Other Employee Benefit Plans

#### (a) Leave Obligation

The leave obligation cover the Group's liability for earned leave and sick leave. The entire amount of the provision of ₹ 531 crore (31/03/2021: ₹ 520 crore) is presented as current, since the Group does not have an unconditional right to defer settlement for these obligations. Expected amount towards settlement of Leave for the next 12 months are ₹ 41 crore (31/03/2021: ₹ 36 crore).

### 31. Power and Fuel

	Year ended	
	31/03/2022	31/03/2021
Power and Fuel Expenses	11,148	8,668
Less: Transferred to Capital Work-in-Progress/Intangible Assets under development	(2)	(1)
	<b>11,146</b>	<b>8,667</b>

### 32. Finance Cost

Refer Note 1B(T) for accounting policy on Borrowing cost

	Year ended	
	31/03/2022	31/03/2021
Interest Expenses on Financial Liabilities not at FVTPL - (a)	3,352	3,760
Interest expense for lease arrangements	56	56
(Gain)/ Loss on Foreign Currency Borrowings (Net)	5	(14)
Loss on Modification and Extinguishment of Debt - (b)	477	125
Other Borrowing Costs - (c)	65	67
	<b>3,955</b>	<b>3,994</b>
Less: Transferred to Capital Work-in-Progress/ Intangible Assets under development - (d)	(187)	(256)
	<b>3,768</b>	<b>3,738</b>

- (a) Includes difference between effective interest rate and contracted interest rate of ₹ 76 crore (31/03/2021: ₹ 68 crore) mainly from amortisation of debt issuance cost.  
It also includes ₹ 11 crore (31/03/2021: ₹ 6 crore) paid to Income Tax Department.
- (b) Loss on modification and extinguishment of debt for the year ended 31/03/2022 is primarily related to refinancing of Senior notes 2026 in August 2021 and prepayment of 2017 Term loan (Refer Note 18A: Borrowings, Non-Current). For the year ended 31/03/2021, it is related to amendment in Short term Credit Agreement and 2017 term loan.
- (c) Includes unwinding of discount on Enterprise Social Commitment and Asset Retirement Obligations - (refer Note 22).
- (d) The capitalisation rate used to determine the amount of borrowing costs capitalised across the Group ranges between 2.77% to 6.32% (31/03/2021: 3.54% to 6.78%).

### 33. Depreciation and Amortisation Expenses

Refer Note 1B(D) -to- (G) for accounting policy on depreciation and amortisation on Property, Plant and Equipment, Investment Property, Intangible Assets (Other than goodwill), and Stripping cost

Refer Note 1B(M) for accounting policy on Leases

	Year ended	
	31/03/2022	31/03/2021
Depreciation of Property, Plant and Equipment	5,515	5,406
Depreciation of Right of Use Assets	345	362
Depreciation of Investment Properties	1	1
Amortisation of Intangible Assets	872	866
	<b>6,733</b>	<b>6,635</b>
Less: Transferred to Capital Work-in-Progress	(4)	(7)
	<b>6,729</b>	<b>6,628</b>

### 34. Impairment Loss/ (Reversal) of Non-Current Assets (Net)

Refer Note 1B(J) for accounting policy on Impairment of Non-Current Assets (excluding Goodwill)

	Year ended	
	31/03/2022	31/03/2021
Impairment Loss	155	145
Impairment Reversal	-	(7)
	<b>155</b>	<b>138</b>

The Group assess the recoverability of property, plant and equipment and intangible assets whenever events or changes in circumstances indicate that the Group may not be able to recover the asset's carrying amount. Such events or circumstances include, but are not limited to, a significant decrease in the fair value of the underlying business, change in utilization of property and equipment and intangible assets, or market factors such as metal price and input costs.

If any indication exists and an impairment testing for an asset is required, the Group estimates the asset's recoverable amount. An asset's recoverable amount is the higher of an asset's or cash-generating unit's (CGU) fair value less costs of disposal and its value in use. Recoverable amount is determined for an individual asset, unless the asset does not generate



# Notes

forming part of the Consolidated Financial Statements

cash inflows that are largely independent of those from other assets or groups of assets. When the carrying amount of an asset or CGU exceeds its recoverable amount, the asset is considered impaired and is written down to its recoverable amount and it will be its new cost basis. For a depreciable asset, the new cost basis will be depreciated over the remaining useful life of that asset. For an amortizable intangible asset, the new cost basis will be amortized over the remaining useful life of the asset.

Impairment loss calculations require management to apply judgments in estimating future cash flows to determine asset fair values, including forecasting useful lives of the assets and selecting the discount rate that represents the risk inherent in future cash flows. Impairment charges are recorded in "Impairment Loss/ (Reversal) of Non-Current Assets (Net)" in the Consolidated statement of profit and loss.

For the year ended March 31, 2022, the Group has identified and recognised impairment on its certain non-current assets and the same is summarised in below table:

	Footnote	Note No.	Year ended	
			₹ in Crore)	
			31/03/2022	31/03/2021
<b>Break up of Impairment Loss/ (Reversal) recognised during the year:</b>				
(i) Impairment Loss on items of Property, Plant and Equipment	(a), (d)	2	77	71
(ii) Impairment Loss/ (Reversal) on Capital Work-in-Progress (CWIP)	(b)	2 (f)	19	5
(iii) Impairment Loss on Intangible Assets	(d)	5 (d), (e)	-	44
(iv) Impairment Loss on Assets/ Disposal Group Held for Sale	(c), (e)	15, 51	59	18
			<b>155</b>	<b>138</b>

- (a) During the year, the Group has evaluated operational performance along with current environmental norms of its Di Ammonium Phosphate (DAP) Plant and decided to decommission the same. As a result, the Group has recognized impairment in respect of existing DAP plant amounting to ₹ 77 crore.
- (b) During the year, the Group has impaired certain mining assets of ₹ 19 crore which was underutilized due to various reasons such as environmental clearances etc. Further, during previous year impairment loss has been recognised on CWIP of ₹ 5 crore - refer Note 2 (f)
- (c) In December 2021, the Group decided to sell its entire equity interest in its wholly owned Brazilian subsidiary, Hindalco Do Brasil Industria e Comercio de Alumina Ltda ('Hindalco Do Brazil') and assets and liabilities of the same were classified as 'Disposal Group Held for Sale'. Accordingly the Group recognized an impairment loss of ₹ 59 crore (\$8 million) on the net assets of Hindalco Do Brazil. - (refer Note 51 for further details)
- (d) During the previous year, the Group recognized impairment in respect of certain mining assets in India amounting to ₹ 115 crore on account of operation of these mining assets become unviable due to high cost of production and other operational issues.
- (e) During the previous year, the Group recognised impairment of ₹ 25 crore on certain assets classified as "Disposal Group Held for Sale" based on their future utilisation plan. Further, there was an impairment reversal in Assets Held for Sale in Vietnam to the extent of ₹ 3 crore (USD 0.3 million) and land relating to Ludensheid Germany of ₹ 4 crore (USD 0.5 million) during the previous year.

## 35. Impairment Loss/ (Reversal) on Financial Assets (Net)

Refer Note 1B(Q) for accounting policy on Financial Instruments

	Year ended	
	₹ in Crore)	
	31/03/2022	31/03/2021
Provision for Doubtful Debts, Loans and Other Financial Assets / (written back) (Net)	10	(31)
Bad Debts Loans and Other Financial Assets/ (written back) (Net)	145	5
	<b>155</b>	<b>(26)</b>

## 36. Other Expenses

	Year ended	
	₹ in Crore)	
	31/03/2022	31/03/2021
Consumption of Stores and Spares	4,467	3,552
Repairs to Buildings	352	238
Repairs to Machinery	2,884	2,364
Rates and Taxes	228	165
Leases Expenses - (a)	307	229
Insurance Charges	392	350
Payments to Auditors	68	90
Research and Development	716	638
Freight and Forwarding Expenses (Net) - (b)	6,564	4,541
Donation - (c)	15	10
Directors' Fees and Commission	17	16
(Gain)/ Loss on assets held for sale	-	3
(Gain)/ Loss on Change in Fair Value of Derivatives (Net)	1,796	450
(Gain) /Loss on Foreign Currency Transactions and Translation (Net)	21	(44)
Miscellaneous Expenses - (d)	7,984	5,878
	<b>25,811</b>	<b>18,480</b>
Less: Transferred to Capital Work-in-Progress/ Intangible Assets under development	(31)	(28)
	<b>25,780</b>	<b>18,452</b>
<b>(a) Details of lease expenses not included in the measurement of lease liabilities:</b>		
Short Term Leases	161	111
Variable Lease Payments	129	102
Leases of Low Value Assets	17	16
	<b>307</b>	<b>229</b>

## Notes

forming part of the Consolidated Financial Statements

- (b) Freight and forwarding expenses are net of freight subsidy of ₹ 10 crore (31/03/2021: ₹ 54 crore) on sale of DAP.
- (c) Donation includes ₹ 10 crore (31/03/2021: ₹ 10 crore) paid to AB General Electoral Trust towards political donation, out of which ₹ Nil (31/03/2021: of ₹ 10 crore) paid through Electoral Bonds.
- (d) Miscellaneous expenses include ₹ 0.10 crore (31/03/2021: ₹ 0.04 crore) paid to a firm of solicitors in which one of the Director of the Company is a partner.

### 37. Exceptional Income/ (Expenses) (Net)

Refer Note 1B(AC) for accounting policy on Exceptional Items

	Year ended	
	31/03/2022	31/03/2021
Exceptional Income	841	127
Exceptional Expenses	(259)	(619)
	<b>582</b>	<b>(492)</b>

Details of Exceptional Income/ (Expenses) are given below:

	Year ended	
	31/03/2022	31/03/2021
<b>Exceptional Income</b>		
(a) Recognition of benefit received as a result of multiple favourable rulings from the Brazilian Supreme Court that recognized the right to exclude certain taxes related to Program for Social Integration (PIS) And Contribution for the Financing of Social Security (COFINS) on gross methodology for the years 2009 to 2017, net of litigation cost. (Principal ₹ 367 crore (\$ 50 million); Interest ₹ 241 crore (\$ 33 million); Litigation cost ₹ (9) crore (\$ 1 million)).	599	-
(b) Gain of sale of controlling interest (90% equity ownership) in Saras Micro Devices, Inc. by Novel-is. As part of this transaction the Group has received total consideration of ₹ 112 crore (\$ 15 million). (refer Note 51 B)	112	-
(c) Recognition of benefit received as a result of favourable rulings regarding tax rebates for sales to Manaus, Brazilian Free Trade Zone (Reintegra). (Principal ₹ 60 crore (\$ 8 million); Interest ₹ 25 crore (\$ 4 million)).	85	-
(d) Reversal of Employee severance cost pursuant to restructuring program in a manufacturing unit in Novelis, Germany.	45	-
(e) Renewable Energy Certificates (REC) recognised subsequent to approval received from Odisha Electricity Regulatory Commission (OERC) permitting adjustment of excess REC purchased during earlier years against future Renewable Power Obligation (RPO) and reversal of excess Renewal Power Obligation (RPO) provision related to FY20 subsequent to Madhya Pradesh Electricity Regulatory Commission (MPERC) order.	-	127
	<b>841</b>	<b>127</b>
<b>Exceptional Expenses</b>		
(f) Loss on sale of a wholly owned subsidiary, 'Hindalco do Brasil' - (refer note 51)	(152)	-
(g) Pursuant to the notification by Ministry of Environment, Forest and Climate Change (MoEFCC), the Group has recognised a provision for expected cost of disposal of legacy ash lying in ash dykes/ponds as at December 31, 2021. The above provision is estimated based on the plan for disposal of ash and stabilisation of ash dykes/ponds (subject to approval of Pollution Control Board) considering feasibility of extraction of ash from ash dykes/ponds.	(107)	-

	Year ended	
	31/03/2022	31/03/2021
(h) Charitable Donation to support COVID 19 pandemic relief measures	-	(395)
(i) Employee severance cost pursuant to restructuring program in a manufacturing unit in Novelis Germany and in a mining operation in India	-	(131)
(j) Exgratia amount paid to the employees for their contribution during COVID 19 pandemic	-	(54)
(k) Provision related to Additional Surcharge (ASC) and Cross Subsidy Surcharge (CSS) levied on the Company due to failure of the captive power producer (from whom the Company sourced power in earlier years) to comply with the captive status criteria under Central Electricity Act, 2003	-	(39)
	<b>(259)</b>	<b>(619)</b>

### 38. Other Comprehensive Income/ (Loss)

The disaggregation of changes to other comprehensive income (OCI) by each class is given below:

	Year ended					
	31/03/2022			31/03/2021		
	Gross	Tax	Net	Gross	Tax	Net
<b>(i) Items that will not be reclassified to Statement of Profit and Loss (Net)</b>						
Remeasurement of Defined Benefit Obligation	1,172	(289)	883	1,117	(308)	809
Remeasurement of Defined Benefit Obligation of Discontinued Operations	-	-	-	60	(9)	51
Change in Fair Value of Equity Instruments designated as FVTOCI	1,211	(248)	963	4,358	(10)	4,348
Share in Equity Accounted Investments	-	-	-	-	-	-
	<b>2,383</b>	<b>(537)</b>	<b>1,846</b>	<b>5,535</b>	<b>(327)</b>	<b>5,208</b>
<b>(ii) Items that will be reclassified to Statement of Profit and Loss (Net)</b>						
Change in Fair Value of Debt Instruments Designated as FVTOCI	(9)	3	(6)	(9)	3	(6)
Effective portion of Cash Flow Hedges	(4,867)	1,403	(3,464)	(1,769)	501	(1,268)
Cost of Hedging Reserve	(75)	26	(49)	(168)	59	(109)
Foreign Currency Translation Reserve	525	-	525	959	-	959
	<b>(4,426)</b>	<b>1,432</b>	<b>(2,994)</b>	<b>(987)</b>	<b>563</b>	<b>(424)</b>
<b>Total Other Comprehensive Income/ (loss)</b>	<b>(2,043)</b>	<b>895</b>	<b>(1,148)</b>	<b>4,548</b>	<b>236</b>	<b>4,784</b>



# Notes

forming part of the Consolidated Financial Statements

## 39. Earnings Per Share (EPS)

	(₹ in Crore)	
	Year ended	
	31/03/2022	31/03/2021
Profit/ (Loss) for the year from Continuing Operations		
As per Consolidated Statement of Profit and Loss	14,201	5,182
Less: Non-Controlling Interests in Profit/ (Loss)	-	-
Profit/ (Loss) from Continuing Operations attributable to Owners of the Company	<b>14,201</b>	<b>5,182</b>
Profit/ (Loss) for the year from Discontinued Operations		
As per Consolidated Statement of Profit and Loss	(471)	(1,699)
Less: Non-Controlling Interests in Profit/ (Loss)	-	-
Profit/ (Loss) from Discontinued Operations attributable to Owners of the Company	<b>(471)</b>	<b>(1,699)</b>
<b>Profit/ (Loss) attributable to Owners of the Company from Continuing and Discontinued Operations</b>	<b>13,730</b>	<b>3,483</b>
<b>Weighted average number of equity shares for calculation of EPS:</b>		
Weighted average number of equity shares for Basic EPS	2,224,071,351	2,224,224,042
Dilutive impact of Employee Stock Options Scheme	2,968,669	1,172,360
Weighted average number of equity shares for Diluted EPS	2,227,040,020	2,225,396,402
Face value of per Equity Share (₹)	1.00	1.00
<b>Earnings Per Share</b>		
Basic - Continuing Operations (₹)	63.85	23.30
Diluted - Continuing Operations (₹)	63.77	23.29
Basic - Discontinued Operations (₹)	(2.12)	(7.64)
Diluted - Discontinued Operations (₹)	(2.12)	(7.64)
Basic - Continuing and Discontinued Operations (₹)	61.73	15.66
Diluted - Continuing and Discontinued Operations (₹)	61.65	15.65

Treasury shares are excluded from weighted-average numbers of equity shares used as a denominator in the calculation of EPS.

Stock options granted to the employees under various ESOP schemes are considered to be potential equity shares. They have been included in the determination of diluted earnings per share to the extent to which they are dilutive. 538,978 shares (31/03/2021: 4,295,432 shares) options granted under Employee Stock option scheme but were not included in the calculation of diluted earnings per share because they are antidilutive for the period. Options can potentially dilute basic earnings per share in the future depending on future share price of the Company. The stock options have not been included in the determination of basic earnings per share. The details relating to stock options are under Note 41.

## 40. Segment Information:

Refer Note 1B(AB) for accounting policy on Segment Reporting

Description of each of the reporting segments is as under:

- i. Aluminium Segment: This segment represents Aluminium business of the Company and subsidiaries of the Company namely, Utkal Alumina International Limited, Hindalco Almix Aluminium Limited, Suvas Holdings Limited and Minerals and Minerals Limited.
- ii. Copper Segment: This segment represents Copper Business of the Company and subsidiaries of the Company namely, Birla Copper Asoj Private Limited and Dahej Harbour and Infrastructure Limited.
- iii. Novelis Segment: This segment represents Novelis Inc, a wholly owned foreign subsidiary, engaged in producing and selling aluminium sheet and light gauge products and operating in all four continents viz. North America, South America, Europe and Asia. This is identified as a separate reportable segment based on its geographical area and regulatory environment.
- iv. All Other Segment: This segment represents remaining subsidiaries of the Group which are not part of the above segments.

The chief operating decision maker (CODM) primarily uses earnings before interest, tax, depreciation and amortisation (EBITDA) as performance measure to assess the performance of the operating segments. However, the CODM also receives information about the segment's revenues, segment assets and segment liabilities on regular basis.

During the year, in line with the changes in the internal structure for reporting financial information to the entity's chief operating decision maker (CODM), the Group has changed its segment disclosure related to segment performance for Aluminium and Copper segments in the consolidated financial statements as per Ind AS 108 "Operating Segments". Corporate expenses and certain other items of income/expenses like (gain)/loss on disposals of property, plant and equipment (PPE), re-structuring expenses, etc., which were previously included as a part of segment performance of Aluminium and Copper segments are now excluded from segment performance of these segments as these are not considered to be directly related to operations of Aluminium and Copper segments. There is no change in the measure of performance with respect to 'Novelis Segment' and 'All Other Segments'. The corresponding segment information of previous year has been restated accordingly.

### A. Segment Profit or Loss:

Segment's performance are measured based on Segment EBITDA. Segment EBITDA is defined as under:

For Aluminium segment and Copper segment:

Segment EBITDA is "Earnings before Finance Costs, Exceptional Income / (Expenses), Tax Expenses, Depreciation and Amortization, Impairment of Non-Current Assets, Investment Income, Fair value gains/ (losses) on financial assets, share in profit/ (loss) in equity accounted investments, Corporate Income/ (Expenses) and certain Unallocable Income/ (Expenses) which are not related to the performance of the segment".

For Novelis segment:

For Novelis segment the Group uses "adjusted EBITDA" as its Segment income measurement. Adjusted EBITDA is earnings before (a) depreciation and amortization; (b) finance cost - net; (c) interest income; (d) unrealized gains or losses on change in fair value of derivative instruments, net, except for foreign currency remeasurement hedging activities, which are included in segment income; (e) impairment loss or reversal on non financial assets, net; (f) gain or loss on extinguishment of debt; (g) restructuring costs; (h) profit or loss on plant property and equipment and intangibles sold or discarded, net; (i) other costs/income, net; (j) litigation settlement, net of insurance recoveries; (k) sale transaction fees; (l) cumulative effect of accounting change, net of tax; (m) metal price lag; (n) exceptional income or cost; (o) business acquisition and other integration related costs; (p) purchase price accounting adjustments; and (q) gains or losses from discontinued operations, net of tax which is in line with the segment information for Novelis that has been reported in accordance with its US GAAP financial information filed with the Securities Exchange Commission of the United States of America. Recognition and measurement differences between US GAAP and Ind AS accounting policies have been separately identified as part of reconciliation in the segment information. Gains and losses on metal derivative contracts are not recognized in "Segment income" until realized.

# Notes

forming part of the Consolidated Financial Statements

For All Other segments:

This segment represents remaining subsidiaries of the Group which are the separate legal entities. For this Segment EBITDA is "Earnings before Finance Costs, Exceptional Income / (Expenses), Tax Expenses, Depreciation, Amortization and Impairment of Non-Current Assets and certain expenditure not directly related to operations".

Segment EBITDA are as follows:

	(₹ in Crore)	
	Year ended	
	31/03/2022	31/03/2021
Novelis	15,229	12,727
Aluminium	13,025	5,441
Copper	1,390	869
All Other Segments	26	26
<b>Total Segment EBITDA</b>	<b>29,670</b>	<b>19,063</b>

Segment EBITDA reconciles to Profit/ (Loss) before Tax from Continuing and Discontinued Operations as follows:

	(₹ in Crore)	
	Year ended	
	31/03/2022	31/03/2021
Total Segment EBITDA	29,670	19,063
Finance Cost	(3,768)	(3,738)
Depreciation and Amortization	(6,729)	(6,628)
Impairment Loss/ (Reversal) of Non-current Assets (Net)	(155)	(138)
Share in Profit/ (Loss) in Equity Accounted Investments (Net of Tax)	6	5
Exceptional Income / (Expenses) (Net) *	164	(492)
Interest Income	146	118
Dividend Income	32	25
Gains/ (losses) on Financial Investments Measured at FVTPL (Net)	359	542
Adjustment on account of different accounting policies for Novelis Segment	323	585
Other Unallocated Income/ (Expenses) (Net)	(474)	(1,437)
<b>Profit/ (Loss) before Tax from Continuing Operations</b>	<b>19,574</b>	<b>7,905</b>
Profit/ (Loss) before Tax from Discontinued Operations	(464)	(2,066)
<b>Profit/ (Loss) before Tax from Continuing and Discontinued Operations</b>	<b>19,110</b>	<b>5,839</b>

\* Exceptional Income / (Expenses) for the year ended March 31, 2022, exclude ₹ 418 crore which represents the principal portion of (a) PIS/COFINS related tax credit income in Brazil ₹ 358 crore (net of litigation cost of ₹ 9 crore) and (b) tax rebates for sales to Manaus, Brazilian Free Trade Zone ₹ 60 crore, as it is included in the results of Novelis segment.

Following amount are either included in the measure of segment profit or loss reviewed by the CODM or are regularly provided to the CODM:

	(₹ in Crore)				
	Year ended				
	31/03/2022				
	Novelis	Aluminium	Copper	All Others	Total
Interest Income - (a)	-	24	55	-	79
Gains/ (losses) on Financial Assets Measured at FVTPL (Net)	-	-	-	-	-
Depreciation and Amortization - (b)	4,581	1,913	178	16	6,688
Impairment Loss/ (Reversal) of Non-Current Assets (Net) - (b)	-	19	76	-	95

	(₹ in Crore)				
	Year ended 31/03/2021				
	Novelis	Aluminium	Copper	All Others	Total
Interest Income - (a)	-	18	45	-	63
Gains/ (losses) on Financial Assets Measured at FVTPL (Net)	-	-	-	1	1
Depreciation and Amortization - (b)	4,570	1,836	167	19	6,592
Impairment Loss/ (Reversal) of Non-Current Assets (Net) - (b)	(2)	140	-	-	138

- (a) Represents interest income from customers/ security deposits etc. which are included in the measure of segment profit or loss.
- (b) Not included in the measure of segment profit or loss but provided to the CODM.

Due to change in measurement of segments performance, segment EBITDA for "Aluminium Segment" and "Copper Segment" have increased with corresponding change in "Unallocable Income/ (Expense) (Net)" as under:

	(₹ in Crore)	
	Year ended	
	31/03/2022	31/03/2021
Aluminium Segment	793	586
Copper Segment	196	153
<b>Unallocable Income/ (Expense) (Net)</b>	<b>(989)</b>	<b>(739)</b>

## B. Segment Revenue:

For all reportable segments except Novelis, the segment revenue is measured in the same way as measured in the Statement of Profit and Loss.

In case of Novelis segment, CODM reviews its financial performance as those are reported under US GAAP, accordingly Novelis segment revenue is measured as the revenue reported under US GAAP financial reporting. The difference between 'Segment Revenue' reported under USGAAP and 'Revenue' reported under Ind AS together with any adjustment item identified between US GAAP and Ind AS is shown as "Adjustment on account of different accounting policies for Novelis Segment".



# Notes

forming part of the Consolidated Financial Statements

Sales between operating segments are eliminated on consolidation. Segment Revenue and reconciliation of the same with total revenue as follows:

	Year ended					
	31/03/2022			31/03/2021		
	Segment Revenue	Inter-segment Revenue	Revenue from external customers	Segment Revenue	Inter-segment Revenue	Revenue from external customers
Novelis	127,747	-	127,747	91,130	-	91,130
Aluminium	32,169	29	32,140	20,518	15	20,503
Copper	36,723	26	36,697	22,446	14	22,432
All Other Segments	279	-	279	230	-	230
Adjustment on account of different accounting policies for Novelis Segment	(1,804)	-	(1,804)	(2,287)	-	(2,287)
<b>Total</b>	<b>195,114</b>	<b>55</b>	<b>195,059</b>	<b>132,037</b>	<b>29</b>	<b>132,008</b>

During the year ended March 31, 2022, there are two customers having more than 10% of the Group's total revenue or more than 10% of either of the reportable segments revenue.

Novelis's ten largest customers accounted for approximately 54% and 55% of its segment's total "Revenue from operations" for the year ended March 31, 2022 and 2021, respectively, out of which one major customer contributes to 17% (₹ 22,037 crore) (31/03/2021: 16%, ₹ 13,781 crore) of the Novelis segment's total "Revenue from Operations".

Similarly in Copper segment also, one of the customer contributes more than 10% (₹ 4,282 crore) (31/03/2021: ₹ 2,250 crore) of the Copper segment's total "Revenue from Operations".

The Group's operations are located in India and outside India. The amount of its revenue from external customers analysed by the country in which customers are located irrespective of origin of the goods or services are given below:

	Year ended	
	31/03/2022	31/03/2021
	India	46,553
Outside India	148,506	103,110
<b>Total</b>	<b>195,059</b>	<b>132,008</b>

## C. Segment Assets:

For Aluminium segment and Copper segment, segment assets are allocated based on the operations of the segment and the physical location of the asset. However, certain assets like investments, equity accounted investments, loans, assets classified as held for sale, current and deferred tax assets are not considered to be segment assets as they are managed at corporate level. Further, corporate administrative assets of an entity having operation which are part of more than one reporting segments are not allocated to individual segments as they also managed at corporate levels and does not linked to any specific segment.

For Novelis segment, segment assets of are measured at the amount of total assets of Novelis Inc. as reported under US GAAP financial reporting. The difference between 'Segment Assets' reported under USGAAP and 'Total Assets' reported under Ind AS together with any adjustment items identified between US GAAP and Ind AS is shown as "Adjustment on account of different accounting policies for Novelis Segment".

In case of All Other segments, Segment assets are measured in the same way as in the financial statements and all the assets are part of this segment as this segments represents the aggregation of subsidiaries which are the separate legal entities and not part of any of above reportable segments.

Segment assets and reconciliation of the same with total assets as follows:

	As at	
	31/03/2022	31/03/2021
	Novelis	114,539
Aluminium	51,280	48,430
Copper	19,407	14,982
All Other Segments	415	486
<b>Total Segment Assets</b>	<b>185,641</b>	<b>158,039</b>
Investment Property	8	7
Investments (Non-Current and Current)	13,863	16,857
Equity Accounted Entities	51	46
Adjustment on account of different accounting policies for Novelis Segment	12,743	12,602
Assets of Discontinued Operations	46	107
Other Corporate Assets	10,710	2,088
<b>Total Assets</b>	<b>223,062</b>	<b>189,746</b>

Following amount are either included in the measure of segment assets reviewed by the CODM or are regularly provided to the CODM:

	As at	
	31/03/2022	31/03/2021
	Investment Property	13
Investments (Non-Current and Current)	205	230

During the year ended 31/03/2022, capital expenditure relating to Novelis, Aluminium, Copper and All Other Segments are ₹ 3321 crore, ₹ 1784 crore, ₹ 225 crore and ₹ 79 crore, respectively (31/03/2021: ₹ 3903 crore, ₹ 1405 crore, ₹ 193 crore and ₹ 12 crore, respectively).

Investment in associates and joint ventures accounted for by the equity method are not allocated to any of the reportable segment.

The total of Non-Current assets excluding goodwill, financial assets, equity accounted investments and deferred tax assets analysed by the country in which assets are located are given below.

	As at	
	31/03/2022	31/03/2021
	India	43,540
Outside India - (a)	45,999	45,220
<b>Total</b>	<b>89,539</b>	<b>88,683</b>
(a) Major geography wise break up of non-current asset located outside India:		
United States	22,342	21,495
Asia and Other Pacific	7,342	6,968
Brazil	6,714	6,686
Canada	363	365
Germany	4,294	4,583
Rest of Europe	4,944	5,123
<b>Total</b>	<b>45,999</b>	<b>45,220</b>

# Notes

forming part of the Consolidated Financial Statements

## D. Segment Liabilities:

For Aluminium segment and Copper segment, Segment liabilities are allocated based on the operations of the segment. In measurement of Aluminium and Copper segment's liabilities, items like borrowings, current and deferred tax liabilities, liabilities associated with assets classified as held for sale etc. are not considered to be segment liabilities as they are managed at corporate level. Further, corporate administrative liabilities of an entity having operation which are part of more than one reporting segments are not allocated to individual segments as they also managed at corporate levels and does not linked to any specific segment.

In case of Novelis segment, segment liabilities are measured at the amount of all the liabilities of Novelis Inc., except borrowings, as reported under US GAAP financial reporting. The difference between 'Segment Liabilities' reported under USGAAP and 'Total Liabilities' reported under Ind AS together with any adjustment items identified between US GAAP and Ind AS is shown as "Adjustment on account of different accounting policies for Novelis Segment".

In case of All Other segments, Segment liabilities are measured in the same way as in the financial statements and all the liabilities except borrowings are part of this segment.

Segment liabilities and reconciliation of the same with total liabilities as follows:

	(₹ in Crore)	
	As at	
	31/03/2022	31/03/2021
Novelis	53,458	36,733
Aluminium	9,763	6,565
Copper	11,541	8,091
All Other Segments	6	156
<b>Total Segment Liabilities</b>	<b>74,768</b>	<b>51,545</b>
Adjustment on account of different accounting policies for Novelis Segment	1,454	1,553
Liabilities of Discontinued Operations	93	119
Borrowings (Non-Current and Current)	63,235	65,978
Other Corporate Liabilities	5,310	4,008
<b>Total Liabilities</b>	<b>144,860</b>	<b>123,203</b>

## 41. Employee Share-Based Payments

Refer Note 1B(W) for accounting policy on Employee Share-based Payments

The Group has formulated employee share-based payment schemes with objective to attract and retain talent and align the interest of employees with the Group as well as to motivate them to contribute to its growth and profitability. The Group views employee stock options as instruments that would enable the employees to share the value they create for the Group in the years to come. At present four employee share-based payment schemes are in operation at Hindalco Industries Limited, the Parent, whereas three employee share-based payment schemes are in operation at Novelis Inc., a subsidiary of the Company. Details of these employee share-based schemes are given below:

### A. Employee share-based payments at Parent

#### (a) Employee Stock Option Scheme 2006 ("ESOS 2006"):

The shareholders of the Company has approved on 23/01/2007 an Employee Stock Option Scheme 2006 ("ESOS 2006") under which the Company may grant 3,475,000 stock options to its permanent employees in the management cadre, whether working in India or out of India, including Managing and the Whole Time Directors of the Company, in one or more tranches. The ESOS 2006 is administered by the Nomination and Remuneration Committee of the Board of Directors

of the Company ("the Committee"). Each stock option when exercised would be converted into one fully paid-up equity share of ₹ 1/- each of the Company. The stock options will vest in 4 equal annual instalments after completion of one year of service from the date of grant. The exercise price shall be average price of the equity shares of the Company in the immediate preceding seven day period on the date prior to the date on which the ESOS compensation committee finalises the specific numbers of Options to be granted to the employees discounted by such percentage not exceeding 30 % (thirty percent) to be determined by ESOS Compensation Committee in the best interest of the various stake holders in the prevailing market conditions. The maximum period of exercise is 5 years from the date of vesting and these stock options do not carry rights to dividends or voting rights till the date of exercise. Further, forfeited/ expired stock options are also available for grant. Further, on 23/09/2011 the ESOS 2006 has been partially modified and by which the Company may grant 6,475,000 stock options to its eligible employees.

Under the ESOS 2006, till 31/03/2022 the Committee has granted 4,328,159 stock options (31/03/2021: 4,328,159 stock options) to its eligible employees out of which 1,819,941 stock options (31/03/2021: 1,819,941 stock options) has been forfeited/ expired and are available for grant as per term of the Scheme. A summary of movement of the stock options and weighted average exercise price (WAEP) is given below:

	Year ended			
	31/03/2022		31/03/2021	
	Number	WAEP (₹ )	Number	WAEP (₹ )
Outstanding at beginning of the year	391,304	118.73	456,956	118.73
Granted during the year	-	-	-	-
Forfeited during the year	-	-	-	-
Exercised during the year	(391,304)	118.73	(65,652)	118.73
Expired during the year	-	-	-	-
Outstanding at year end	-	-	391,304	118.73
Vested and Exercisable at year end	-	-	391,304	118.73

Under ESOS 2006, as at 31/03/2022 the range of exercise prices for stock options outstanding was ₹ Nil (31/03/2021: ₹ 118.73) whereas the weighted average remaining contractual life for the stock options outstanding was Nil (31/03/2021: 1.02 years).

The weighted average share price at the date of exercise of ESOS 2006 was ₹ 428.07 per share (31/03/2021: ₹ 173.25 per share).

#### (b) Employee Stock Option Scheme 2013 ("ESOS 2013"):

The shareholders of the Company has approved on 10/09/2013 an Employee Stock Option Scheme 2013 ("ESOS 2013"), under which the Company may grant up to 5,462,000 Options (comprising of Stock Options and/ or Restricted Stock Units (RSU)) to the permanent employees in the management cadre and Managing and Whole time Directors of the Company and its subsidiary companies in India and abroad, in one or more tranches. The ESOS 2013 is administered by the Nomination and Remuneration Committee of the Board of Directors of the Company ("the Committee"). The stock options exercise price would be determined by the Committee, whereas the RSUs exercise price shall be the face value of the equity shares of the Company as at the date of grant of RSUs. Each stock option and each RSU entitles the holders to apply for and be allotted one fully paid-up equity share of ₹ 1/- each of the Company upon payment of exercise price during exercise period. The stock options will vest in 4 equal annual instalments after completion of one year of the services from the date of grant, whereas RSU will vest upon completion of three years of services from the date of grant. The maximum period of exercise is 5 years from the date of vesting and these stock option/ RSU do not carry rights to dividends or voting rights till the date of exercise. Further, forfeited/ expired stock options and RSUs are also available for grant.



# Notes

forming part of the Consolidated Financial Statements

In terms of ESOS 2013, till 31/03/2022 the Committee has granted 2,250,754 stock options and 2,252,254 RSUs (31/03/2021: 2,250,754 stock options and 2,252,254 RSUs) to the eligible employees of the Company and some of its subsidiary companies. Further, 301,381 stock options and 213,095 RSUs (31/03/2021: 296,996 stock options and 202,063 RSUs) have been forfeited/ expired and are available for grant as per term of the Scheme.

A summary of movement of stock options and RSUs and weighted average exercise price (WAEP) is given below:

	Year ended							
	31/03/2022				31/03/2021			
	Stock Options		RSUs		Stock Options		RSUs	
	Number	WAEP (₹)	Number	WAEP (₹)	Number	WAEP (₹)	Number	WAEP (₹)
Outstanding at beginning of the year	110,700	132.68	55,691	1.00	415,944	124.82	235,718	1.00
Granted during the year	-	-	-	-	-	-	-	-
Forfeited during the year	-	-	-	-	(37,086)	144.19	(8,776)	1.00
Re-instated during the year	-	-	-	-	-	-	-	-
Exercised during the year	(80,067)	132.52	(17,106)	1.00	(224,657)	119.02	(171,251)	1.00
Expired during the year	(4,385)	119.45	(11,032)	1.00	(43,501)	119.45	-	-
Outstanding at year end	26,248	135.39	27,553	1.00	110,700	132.68	55,691	1.00
Vested and Exercisable at year end	26,248	135.39	27,553	1.00	110,700	132.68	55,691	1.00

Under ESOS 2013, the range of exercise prices for stock options outstanding as at 31/03/2022 was ₹ 119.45 to ₹ 167.15 (31/03/2021: ₹ 119.45 to ₹ 167.15) whereas exercise price in case of RSUs was ₹ 1 (31/03/2021: ₹ 1). The weighted average remaining contractual life for the stock options and RSUs outstanding as at 31/03/2022 was 1.09 years and 2.73 years, respectively (31/03/2021: 1.51 years and 2.54 years, respectively).

The weighted average share price at the date of exercise of ESOS 2013 was ₹ 460.52 per share (Number: ₹ 220.69 per share).

### (c) Employee Stock Option Scheme 2018 ("ESOS 2018"):

The shareholders of the company has approved on 21/09/2018 an Employee Stock Option Scheme 2018 ("ESOS 2018"), formulated by the company, under which the Company may grant not more than 13,957,302 (Stock Options and Restricted Stock Units) to its permanent employees of the company in management cadre including Managing and the Whole-time Director of the company and its subsidiary companies in India and abroad, in one or more tranches. The ESOS 2018 is administered by the Nomination and Remuneration Committee of the Board of Directors of the Company ("the Committee") and the Hindalco Employees Welfare Trust ("Trust"). The Stock options exercise price would be determined by the Committee whereas the RSU exercise price shall be the face value of the equity shares of the Company as at the date of grant of RSUs. Each stock option and each RSU entitles the holders to apply for and be allotted one fully paid-up equity share of Re. 1/- each of the Company upon payment of exercise price during the exercise period. The stock options will vest in 4 equal annual instalments after completion of one year of the services from the date of grant, whereas RSU will vest upon completion of three years of services from the date of grant. The maximum period of exercise is 5 years from the date of vesting and these stock options/RSUs do not carry rights to dividends or voting rights till the date of exercise. Further, forfeited/expired stock options and RSUs are also available for grant.

In terms of ESOS 2018, till 31/03/2022 the Committee has granted 7,062,503 stock options and 1,981,539 RSUs (31/03/2021: 5,189,519 stock options and 1,368,979 RSUs) to the eligible employees of the Company and some of its subsidiary companies. A summary of movement of stock options and RSUs and weighted average exercise price (WAEP) is given below:

	Year ended							
	31/03/2022				31/03/2021			
	Stock Options		RSUs		Stock Options		RSUs	
	Number	WAEP (₹)	Number	WAEP (₹)	Number	WAEP (₹)	Number	WAEP (₹)
Outstanding at beginning of the year	4,277,702	226.06	1,279,318	1.00	4,448,494	217.95	1,297,506	1.00
Granted during the year	1,872,984	448.89	612,560	1.00	582,240	278.05	20,487	1.00
Forfeited during the year	17,719	278.05	-	-	(692,325)	218.31	(38,675)	1.00
Re-instated during the year	(155,816)	306.39	(59,936)	1.00	-	-	-	-
Exercised during the year	(687,701)	224.10	(191,267)	1.00	(60,707)	218.80	-	-
Expired during the year	-	-	-	-	-	-	-	-
Outstanding at year end	5,324,888	302.51	1,640,675	1.00	4,277,702	226.06	1,279,318	1.00
Vested and Exercisable at year end	2,370,953	228.84	966,695	1.00	1,565,967	218.60	46,058	1.00

Under ESOS 2018, the range of exercise prices for stock options outstanding as at 31/03/2022 was ₹ 159.30 to ₹ 453.95 (31/03/2021: ₹ 159.30 to ₹ 278.05) whereas exercise price in case of RSUs was ₹ 1 (31/03/2021: ₹ 1). The weighted average remaining contractual life for the stock options and RSUs outstanding as at 31/03/2022 was 5.29 years and 5.50 years (31/03/2021: 5.43 years and 5.84 years) respectively.

The weighted average share price at the date of exercise of ESOS 2018 was ₹ 509.37 per share (31/03/2021: ₹ 332.87 per share).

The fair values at grant date of stock options granted during the year ended 31/03/2022 was ₹ 176.04 to ₹ 220.36 (31/03/2021: ₹ 144.57 to ₹ 181.09) and fair values in case of RSUs was ₹ 419.15 to ₹ 435.62 (31/03/2021: ₹ 269.56) respectively. The fair valuation has been carried out by an independent valuer by applying Black and Scholes Model. The inputs to the model include the exercise price, the term of option, the share price at grant date and the expected volatility, expected dividends and the risk free rate of interest for terms of options.

The details of options granted, the key assumptions for Fair Value on the date of grant are as under:

	Year ended							
	31/03/2022				31/03/2021			
	Tranche VII		Tranche VIII		Tranche V		Tranche VI	
	Stock Option	RSU	Stock Option	RSU	Stock Option	RSU	Stock Option	RSU
Grant date	06/08/2021	06/08/2021	12/11/2021	12/11/2021	10/2/2021	10/2/2021	10/2/2021	
Exercise price (₹)	443.25	1.00	453.95	1.00	278.05	1.00	278.05	
Expected terms of options granted (years)	4.43-6.43 yrs	6-8 years	4.43-6.43 yrs	6-8 years	4.43-7.43 yrs	8 years	4.43 yrs	
Share price on grant date (₹)	443.10	443.10	453.95	453.95	279.40	279.40	279.40	
Expected volatility (%)	41.10%	41.10%	41.45%	41.45%	59.50%	59.50%	59.50%	
Expected dividend (%)	0.68%	0.68%	0.66%	0.66%	0.36%	0.36%	0.36%	
Risk free interest rate (%)	5.64% - 6.22%	6.12% - 6.54%	5.54% - 6.12%	6.01% - 6.44%	5.46% - 6.17%	6.27%	5.46%	

The expected volatility was determined based on the historical share price volatility over the past period depending on life of the options granted which is indicative of future periods and which may not necessarily be the actual outcome.

# Notes

forming part of the Consolidated Financial Statements

## (d) Stock Appreciation Rights 2018 ('SAR 2018'):

The Company till 31/03/2022 had granted 156,694 Option SAR and 50,665 RSU SAR (31/03/2021: 95,815 Option SAR and 20,514 RSU SAR) under the Share Appreciation Rights Scheme 2018 ("SAR 2018") to its eligible employees. Option SAR to be vested in 4 equal annual instalments after completion of one year of the service from the date of grant and RSU SAR will vest upon completion of three years of services from the date of grant. The SAR 2018 is administered by the Nomination and Remuneration Committee of the Board of Directors of the Company ("the Committee"). The SAR 2018 have performance linked vesting conditions which are decided by the committee and are cash settled. The options shall lapse in case of performance linked vesting conditions are not met. The range of exercise price of the Option SAR is ₹ 159.30 to ₹ 443.25 and RSU SAR is ₹ 1 (31/03/2021: Option SAR is ₹ 159.30 to ₹ 278.05 and RSU SAR is ₹ 1).

A Summary of movement of SAR 2018 and weighted average exercise price (WAEP) is given below:

	As at							
	31/03/2022				31/03/2021			
	Option SAR		RSU SAR		Option SAR		RSU SAR	
	Number	WAEP (₹)	Number	WAEP (₹)	Number	WAEP (₹)	Number	WAEP (₹)
Outstanding at beginning of the year	76,652	215.00	20,514	1.00	44,668	218.80	11,333	1.00
Granted during the year	60,879	255.50	30,151	1.00	51,147	203.79	9,181	1.00
Forfeited during the year	-	-	-	-	(19,163)	193.97	-	-
Re-instated during the year	-	-	-	-	-	-	-	-
Exercised during the year	(39,604)	223.29	(20,669)	1.00	-	-	-	-
Expired during the year	-	-	-	-	-	-	-	-
Outstanding at year end	97,927	236.82	29,996	1.00	76,652	215.00	20,514	1.00
Vested and Exercisable at year end	47,115	218.80	13,565	-	11,167	218.80	-	-

The fair values per Option SAR as at 31/03/2022 was ₹ 248.38 to ₹ 440.84 (31/03/2021: ₹ 144.97 to ₹ 232.47) and for RSU SAR as at 31/03/2022 was ₹ 552.96 to ₹ 560.60 (31/03/2021: ₹ 321.21 to ₹ 322.35). The fair value has been carried out by an independent valuer by applying Black and Scholes Model. The inputs to the model include the exercise price, the term of option, the share price at grant date and the expected volatility, expected dividends and the risk free rate of interest. The assumptions used for fair valuation are given below:

	Year ended						
	31/03/2022						
Grant date	26/03/2019	09/08/2019	12/06/2020	12/06/2020	10/02/2021	06/08/2021	
Valuation Date	31/03/2022	31/03/2022	31/03/2022	31/03/2022	31/03/2022	31/03/2022	
Exercise price (₹)	1.00	218.80	159.30	1.00	278.05	218.80	
Expected volatility (%)	40.05%	40.05%	40.05%	40.05%	40.05%	40.05%	
Expected dividend (%)	0.53%	0.53%	0.53%	0.53%	0.53%	0.53%	
Risk free interest rate (%)	5.40%	5.72%	5.37% - 6.18%	5.40% - 5.82%	5.34%	5.72%	

	Year ended						
	31/03/2022						
Grant date	06/08/2021	06/08/2021	12/11/2021	12/11/2021	12/11/2021	12/11/2021	
Valuation Date	31/03/2022	31/03/2022	31/03/2022	31/03/2022	31/03/2022	31/03/2022	
Exercise price (₹)	278.05	1.00	218.80	278.05	443.25	1.00	
Expected volatility (%)	40.05%	40.05%	40.05%	40.05%	40.05%	40.05%	
Expected dividend (%)	0.53%	0.53%	0.53%	0.53%	0.53%	0.53%	
Risk free interest rate (%)	5.34%	5.40% - 5.57%	5.26% - 5.72%	5.34%	5.57% - 6.30%	5.26% - 6.30%	

	Year ended						
	31/03/2021						
Grant date	26/03/2019	09/08/2019	09/08/2019	12/06/2020	12/06/2020	10/02/2021	
Valuation Date	31/03/2021	31/03/2021	31/03/2021	31/03/2021	31/03/2021	31/03/2021	
Exercise price (₹)	1.00	218.80	1.00	159.30	1.00	278.05	
Expected volatility (%)	50.90%	50.90%	50.90%	50.90%	50.90%	50.90%	
Expected dividend (%)	0.31%	0.31%	0.31%	0.31%	0.31%	0.31%	
Risk free interest rate (%)	5.45%	4.27% - 5.70%	5.34%	5.43% - 6.05%	5.45% - 5.78%	5.41%	

The weighted average remaining contractual life as at 31/03/2022 for the Option SAR is 2.70 to 5.35 years (31/03/2021: 1.69 to 5.92 years) and for RSU SAR is 2.70 to 5.35 years (31/03/2021: 3.70 to 4.92 years).

The total intrinsic value at the end of the year of the vested Option SAR and RSU SAR is ₹ 2.42 crore (31/03/2021 ₹ 0.12 crore).

## B. Employee share-based payments schemes at Novelis Inc ("Novelis"), a subsidiary of the Group:

The Novelis's Board of Directors has authorized long term incentive plans (LTIPs), under which Hindalco stock appreciation rights (Hindalco SARs), Novelis stock appreciation rights (Novelis SARs), phantom restricted stock units (Phantom RSUs), and Novelis Performance Units (Novelis PUs) are granted to certain executive officers and key employees.

The Hindalco and Novelis SARs vest at the rate of 33% per year, subject to the achievement of an annual performance target, and expire seven years from their original grant date. The performance criterion for vesting of the Hindalco and Novelis SARs is based on the actual overall Novelis operating EBITDA compared to the target established and approved each fiscal year. The minimum threshold for vesting each year is 75% of each annual target operating EBITDA. Each Hindalco SAR is to be settled in cash based on the difference between the market value of one Hindalco share on the date of grant and the market value on the date of exercise. Each Novelis SAR is to be settled in cash based on the difference between the fair value of one Novelis phantom share on the original date of grant and the fair value of a phantom share on the date of exercise. The amount of cash paid to settle Hindalco and Novelis SARs are limited to three times the target pay out, depending on the plan year. The Hindalco and Novelis SARs do not transfer any shareholder rights of Hindalco or Novelis to a participant. The Hindalco and Novelis SARs are classified as liability awards and are re-measured at each reporting period until the SARs are settled or cancelled. Novelis expenses each fiscal year's SAR tranche(s) over the employee requisite service period, which results in the expense being recorded on an accelerated basis.

The Phantom RSUs are based on Hindalco's stock price. The Phantom RSUs vest either in full three years from the grant date or 33% per year over three years, subject to continued employment with Novelis, but are not subject to performance criteria. Each Phantom RSU is to be settled in cash equal to the market value of one Hindalco share. The pay out on the Phantom RSUs is limited to three times the market value of one Hindalco share measured on the original date of grant. The Phantom RSUs are classified as liability awards and expensed over the employee requisite service period (three years) based on the Hindalco stock price as of each balance sheet date.



# Notes

forming part of the Consolidated Financial Statements

In May 2016, the Novelis's board of directors approved the issuance of Novelis PUs which have a fixed USD 100 value per unit and will vest in full three years from the grant date, subject to specific performance criteria compared to the established target. The Novelis PUs awards are not based on the Hindalco or Novelis stock prices and therefore are accounted for in accordance with Ind AS 19 - Employee Benefits.

## (a) Hindalco Stock Appreciation Rights (Hindalco SARs)

	Year ended			
	31/03/2022		31/03/2021	
	Number	WAEP (₹)	Number	WAEP (₹)
Outstanding at beginning of the year	13,038,526	158	12,441,966	177
Granted during the year	2,411,503	388	6,934,923	118
Forfeited during the year	(187,780)	177	(465,886)	180
Exercised during the year	(6,976,625)	177	(5,872,477)	151
Expired during the year	-	-	-	-
Outstanding at year end	8,285,624	208	13,038,526	158
Vested and Exercisable at year end	393,803	164	3,220,946	197

## (b) Novelis Stock Appreciation Rights (Novelis SARs)

	Year ended			
	31/03/2022		31/03/2021	
	Number	WAEP (₹)	Number	WAEP (₹)
Outstanding at beginning of the year	10,165	6,025	33,393	6,532
Granted during the year	-	-	-	-
Forfeited during the year	(4,933)	7,032	(3,349)	5,366
Exercised during the year	(1,660)	6,200	(19,879)	6,781
Expired during the year	-	-	-	-
Outstanding at year end	3,572	4,868	10,165	6,025
Vested and Exercisable at year end	3,572	4,868	10,165	6,025

## (c) Phantom Restricted Stock Units (Phantom RSUs)

	Year ended			
	31/03/2022	31/03/2021	31/03/2022	31/03/2021
	Number	WAEP (₹)	Number	WAEP (₹)
Outstanding at beginning of the year	7,236,419	-	4,747,316	-
Granted during the year	1,787,910	-	5,016,919	-
Forfeited during the year	(266,713)	-	(124,447)	-
Exercised during the year	(3,343,896)	-	(2,403,369)	-
Expired during the year	-	-	-	-
Outstanding at year end	5,413,720	-	7,236,419	-

## (d) Particulars of share based payment

i. Carrying amount and intrinsic value of liabilities given below:

	Year ended			
	31/03/2022		31/03/2021	
	Total carrying amount at the end of the year for liabilities	Total intrinsic value at the end of the year of liabilities (vested portion)	Total carrying amount at the end of the year for liabilities	Total intrinsic value at the end of the year of liabilities (vested portion)
Hindalco SAR	113	18	118	60
Novelis SAR	1	1	3	4
Phantom RSU	176	-	145	-
	290	19	266	64

ii. Number of options exercised and the weighted average exercise price given below:

	Year ended			
	31/03/2022		31/03/2021	
	Number of options exercised	Weighted average exercise price	Number of options exercised	Weighted average exercise price
Hindalco SAR (price in ₹)	6,976,625	177	5,872,477	151
Novelis SAR (price in ₹)	1,660	6,200	19,879	6,781
Phantom RSU (price in ₹)	3,343,896	-	2,403,369	-

## (e) Unrecognised compensation expense

	Year ended			
	31/03/2022		31/03/2021	
	(₹ in Crore)	Period over which expense will be recognised (in years)	(₹ in Crore)	Period over which expense will be recognised (in years)
Hindalco SAR	41	2	37	2
Novelis SAR	-	-	-	-
Phantom RSU	73	2	78	2

(f) Inputs to the model used to determine fair value are as under:

	Year ended			
	31/03/2022		31/03/2021	
	Hindalco SAR	Novelis SAR	Hindalco SAR	Novelis SAR
Risk free interest rate (%)	3.59% - 6.58%	0.23% - 0.23%	3.32% - 6.18%	0.03% - 0.08%
Dividend yield (%)	0.48%	0.00%	0.32%	-
Volatility (%)	39.49% - 49.69%	28.96% - 28.96%	40.4% - 57.1%	28.2% - 45.1%
Source of historical volatility	Hindalco historical volatility	Comparable companies	Hindalco historical volatility	Comparable companies
Model used	Monte Carlo Simulation Model	Monte Carlo Simulation Model	Monte Carlo Simulation Model	Monte Carlo Simulation Model

The weighted average remaining contractual life as at 31/03/2022 for the Hindalco SAR is 5 years (31/03/2021: 5 years) and Novelis SAR is less than one year (31/03/2021: 1 year).

# Notes

forming part of the Consolidated Financial Statements

## C. Effect of employee share-based payment transactions on profit or loss for the year and on financial position:

For the year ended 31/03/2022, the Group recognised expenses of ₹ 35 crore (31/03/2021: expenses of ₹ 15 crore) related to equity-settled share based transactions, whereas ₹ 307 crore as expenses (31/03/2021: expenses ₹ 286 crore) towards cash-settled share based transactions accounted for as part of Employee Benefits Expenses. (refer Note 30)

During the year ended 31/03/2022, the Company has allotted 488477 fully paid-up equity share of ₹1/- each of the Company (31/03/2021: 461560) on exercise of equity settled options for which the Group has realised ₹ 6 crore (31/03/2021: ₹ 3 crore) as exercise prices.

## 42. Related party transactions

The Group's related parties principally consist of its associates, joint ventures, other related parties and its key managerial personnel. The Group routinely enters into transactions for sale and purchase of products and rendering and receiving services with these related parties. Transactions and balances between the Parent, subsidiaries and fellow subsidiaries and trusts, which are related parties of the Company, have been eliminated on consolidation. List of all the related parties to be included in consolidated related parties disclosures and details of transactions and balances between the Group and other related parties are disclosed below:

### (A) List of Related Parties with joint control and significant influence:

Name of the Related Party	Principal Place of Business
<b>(a) Joint Ventures:</b>	
1. MNH Shakti Limited	India
2. Hydromine Global Minerals (GMBH) Limited	British Virgin Islands
<b>(b) Associates:</b>	
1. Aditya Birla Science & Technology Company Pvt. Limited	India
2. Aditya Birla Renewable Subsidiary Limited	India
3. Aditya Birla Renewable Utkal Limited	India
4. Aditya Birla Renewable Solar Limited	India
5. France Aluminum Recyclage SPA.	France
6. Deutsche Aluminum Verpackung Recycling GMBH	Germany

### (B) Key Managerial Personnel:

Name of the Related Party	Relationship
1. Mr. Satish Pai - Managing Director	Executive Directors
2. Mr. Praveen Maheshwari -Whole time Director & Chief Financial Officer	Executive Directors
3. Mr. Kumar Mangalam Birla	Non Executive Directors
4. Smt. Rajashree Birla	Non Executive Directors
5. Mr. D Bhattacharya (Resigned w.e.f. 2nd March, 2022)	Non Executive Directors
6. Mr. A.K.Agarwala	Non Executive Directors
7. Mr. K.N. Bhandari	Non Executive Directors
8. Mr. Y.P. Dandiwala	Non Executive Directors
9. Mr. Anant Maheshwari	Non Executive Directors
10. Ms. Alka Bharucha	Non Executive Directors
11. Dr. Vikas Balia	Non Executive Directors
12. Mr. Sudhir Mital	Non Executive Directors

### (C) Other Related Parties with whom there were transactions during the year:

	Name of the Related Party	Relationship
1	Hindalco Employee's Gratuity Fund, Kolkata	Post-Employment Benefit Plan
2	Hindalco Employee's Gratuity Fund, Renukoot	Post-Employment Benefit Plan
3	Hindalco Employee's Provident Fund Institution, Renukoot	Post-Employment Benefit Plan
4	Hindalco Superannuation Scheme, Renukoot	Post-Employment Benefit Plan
5	Hindalco Industries Limited Employees' Provident Fund II	Post-Employment Benefit Plan
6	Hindalco Industries Limited Senior Management Staff Pension Fund II	Post-Employment Benefit Plan
7	Aditya Birla Management Corporation Private Limited <sup>®</sup>	Other related party in which Director is Interested

<sup>®</sup> The Company and its subsidiary, Utkal Alumina International Limited, are members of Aditya Birla Management Corporation Private Limited (ABMCPL), a company limited by guarantee formed for the purpose of its members to mutually avail and share common facilities, expertise and other support charged on cost basis.

### (D) The following transactions were carried out with the related parties in the ordinary course of business

(₹ in Crore)

Nature of Transaction/Relationship	Year ended	
	31/03/2022	31/03/2021
<b>i. Services rendered</b>	<b>15</b>	<b>10</b>
Other related party in which Director is interested	15	10
<b>ii. Interest and dividend received</b>		
<b>Interest received</b>	<b>2</b>	<b>2</b>
Associates	2	2
<b>iii. Purchase of Materials, Capital Equipment and Others</b>	<b>25</b>	<b>20</b>
Associates	25	20
<b>iv. Contribution to</b>	<b>213</b>	<b>208</b>
Post-Employment Benefit Plan	213	208
<b>v. Services received</b>	<b>615</b>	<b>433</b>
Associates	17	16
Other related party in which Director is interested	598	417
<b>vi. Investments, Deposits and Loans</b>		
<b>Investments made during the year</b>	<b>8</b>	<b>-</b>
Associates	8	-
<b>Investments, Deposits and Loans, returned back during the year</b>	<b>12</b>	<b>5</b>
Associates	4	5
Joint Ventures	8	-

### (E) Outstanding Balances

(₹ in Crore)

Nature of Transaction/Relationship	Year ended	
	31/03/2022	31/03/2021
<b>Receivables and Advances</b>	<b>106</b>	<b>102</b>
Other related party in which Director is interested	106	102
<b>Payables</b>	<b>81</b>	<b>38</b>
Associates	2	2
Other related party in which Director is interested	79	36
<b>Loans and Deposits (Given)</b>	<b>36</b>	<b>41</b>
Associates	36	41

All outstanding balances are unsecured and are payable in cash.



# Notes

forming part of the Consolidated Financial Statements

## (F) Compensation of Key Managerial Personnel of the Company

(₹ in Crore)

	Year ended	
	31/03/2022	31/03/2021
<b>(a) Remuneration of Executive Directors - (i) and (ii)</b>	<b>54</b>	<b>30</b>
Short term employment benefit	52	28
Post employment benefits	2	2
<b>(b) Remuneration to erstwhile Managing Director - (iii)</b>	<b>4</b>	<b>4</b>
Post-employment benefits	4	4
<b>(c) Remuneration of Non Executive Directors</b>	<b>9</b>	<b>8</b>
Commission and Sitting Fees	9	8

- (i) Excludes amortisation of fair value of employee share-based payments under Ind AS 102.
- (ii) As the liabilities for defined benefit plans and leave entitlements are provided on actuarial basis for the Company as a whole, the amounts pertaining to Key Management Personnel are not included.
- (iii) The Board approved pension of Mr. D. Bhattacharya of ₹ 0.335 crore per month and other post-employment benefits for his past service when he was the Managing Director of the Company. The present value of the above pension liability determined based on the actuarial valuation is accounted by the Group in the consolidated financial statements. Amount charged as expenses in the consolidated statement of profit and loss during the year towards such post-employment benefit amounting to ₹ 3 crore (31/03/2021: ₹ 3 crore) has been disclosed as a part of managerial remuneration above, and does not include the impact of actuarial (gains)/losses recognised in other comprehensive income.

## 43. Contingent Liabilities and Commitments

Refer Note 1B(L) for accounting policy on Provisions and Contingencies

### A. Contingent Liabilities

The Group is party to, and may in the future be involved in, or subject to, disputes, claims and proceedings arising in the ordinary course of our business, including some we assert against others, such as environmental, health and safety, product liability, employee, tax, personal injury and other matters. The Group has established a liability with respect to contingencies for which a loss is probable and estimable. While the ultimate resolution of and liability and costs related to these matters cannot be determined with certainty, the Management does not believe any of these pending actions, individually or in the aggregate, will materially impact our operations or materially affect our financial condition or liquidity.

The Group's estimates involve significant judgment, and therefore, the estimate will change from time to time and actual losses may differ from the current estimate. Management review the status of, and estimated liability related to, pending claims and civil actions on a quarterly basis. The evaluation model includes all asserted and unasserted claims that can be reasonably identified including claims relating to our responsibility for compliance with environmental, health and safety laws and regulations in the jurisdictions in which the Group operate or formerly operated. The estimated costs in respect of such reported liabilities are not offset by amounts related to insurance or indemnification arrangements unless otherwise noted.

The amount for which the Group is contingently liable are given below:

(₹ in Crore)

	As at	
	31/03/2022	31/03/2021
<b>(a) Claims against the Group not acknowledged as debt</b>		
Tax matters - Direct Taxes - (i)	5	2
Tax matters - Indirect Taxes - (ii)	693	640
Legal and Other matters - (iii)	224	300

#### (i) Tax matters - Direct Taxes:

The Group has ongoing disputes with direct tax authorities in various tax jurisdictions relating to tax treatment of certain items in the Company and some of its subsidiaries. These mainly include claims disallowed, tax treatment of certain items of income/expense, use of certain tax incentives or allowances, etc. in their tax computation.

#### (ii) Tax matters - Indirect Taxes:

There are pending litigations for various matters relating to customs, excise duty and service tax, VAT across various entities in the Group involving demands, including interest and penalties.

#### (iii) Legal and Other matters:

In addition to above matters certain Group companies are involved in several other legal claims including revenue matters, environmental matters, civil and Labour matters.

#### (b) Other money for which the Group is contingently liable:

(i) Customs Duty on Raw Materials imported under Advance License, against which export obligation is to be fulfilled.	24	-
---	----	---

(c) For contingent liabilities relating to associates and joint ventures, if any, are given in Note 48 D and 48 E.

### B. Commitments

(₹ in Crore)

	As at	
	31/03/2022	31/03/2021
The Group's commitments with regard to various items in respect of:		
(a) Estimated amount of contracts remaining to be executed on capital account and not provided for	1,122	818
(b) Purchase commitments in relation to Materials and Services (net of advances)	95,946	73,924
(c) The Company has given the following undertaking in connection with the loan of Utkal Aluminium International Limited (UAIL), a wholly owned subsidiary:		
- To hold minimum 51% equity shares in UAIL.		

# Notes

forming part of the Consolidated Financial Statements

## 44. Capital Management

The Group's objective to manage its capital is to ensure continuity of business while at the same time provide reasonable returns to its various stakeholders but keep associated costs under control. In order to achieve this, requirement of capital is reviewed periodically with reference to operating and business plans that take into account capital expenditure and strategic investments. Apart from internal accrual, sourcing of capital is done through judicious combination of equity and borrowing, both short term and long term. Net debt (total borrowings + lease liabilities) to equity ratio is used to monitor capital. No changes were made to the objectives, policies or processes for managing capital during the years ended March 31, 2022 and March 31, 2021.

	As at	
	31/03/2022	31/03/2021
Debt Equity ratio	0.82	1.01

As at March 31, 2022 and March 31, 2021, the Group was in compliance with all of its debt covenants for borrowings.

## 45. Financial Instruments

Refer Note 1B(Q) for accounting policy on Financial Instruments

### A Fair Value Measurements

(a) The following table shows the carrying amount of financial assets and financial liabilities by category.

(₹ in Crore)

	Note No.	As at					
		31/03/2022			31/03/2021		
		Amortised Cost	Fair value through OCI	Fair value through P&L	Amortised Cost	Fair value through OCI	Fair value through P&L
<b>Financial Assets</b>							
<b>Investments in Equity Instruments</b>	6A & 6B						
Quoted Equity Instruments		-	8,239	-	-	7,398	-
Unquoted Equity Instruments		-	48	-	-	30	-
<b>Investments in Preference Shares</b>	6A & 6B	-	-	24	-	-	25
<b>Investments in Debt Instruments</b>	6A & 6B						
Mutual Funds		-	-	5,230	-	-	9,085
Bonds & Debentures		-	-	152	-	-	164
Government Securities		-	375	-	-	385	-
<b>Cash &amp; Cash Equivalents</b>	13						
Cash & Bank		10,977	-	-	7,570	-	-
Liquid Mutual Funds		-	-	662	-	-	769
<b>Bank Balances other than cash &amp; cash equivalents</b>	14	5,753	-	-	470	-	-
<b>Trade receivables</b>	12	20,340	-	736	12,725	-	287
<b>Loans</b>	7	57	-	-	59	-	-
<b>Derivatives</b>	46	-	-	3,671	-	-	1,751
<b>Other financial assets</b>	8A & 8B	2,537	-	380	1,539	-	819
<b>Total Financial Assets</b>		<b>39,664</b>	<b>8,662</b>	<b>10,855</b>	<b>22,363</b>	<b>7,813</b>	<b>12,900</b>

(₹ in Crore)

	Note No.	As at					
		31/03/2022			31/03/2021		
		Amortised Cost	Fair value through OCI	Fair value through P&L	Amortised Cost	Fair value through OCI	Fair value through P&L
<b>Financial Liabilities</b>							
<b>Borrowings</b>	18A & 18B						
Borrowings, Non-Current		51,635	-	-	58,985	-	-
Borrowings, Current		11,600	-	-	6,993	-	-
<b>Lease Liabilities</b>	2	1,251	-	-	1,228	-	-
<b>Supplier's Credit</b>	19	2,456	-	-	255	-	-
<b>Trade Payables</b>	20	36,309	-	5,073	23,464	-	4,771
<b>Derivatives</b>	46	-	-	11,121	-	-	4,028
<b>Other financial Liabilities</b>	21A & 21B	3,746	-	-	2,664	-	-
<b>Total Financial Liabilities</b>		<b>106,997</b>	<b>-</b>	<b>16,194</b>	<b>93,589</b>	<b>-</b>	<b>8,799</b>

(b) The following table shows fair value for financial assets and financial liabilities measured at amortised cost.

(₹ in Crore)

	Note No.	As at			
		31/03/2022		31/03/2021	
		Carrying Value	Fair Value	Carrying Value	Fair Value
<b>Financial Assets (Non-Current)</b>					
Loans and Deposits	7 & 8A	428	428	340	340
<b>Financial Liabilities (Non-Current)</b>					
Borrowings, Non-Current #	18A	57,814	57,667	59,907	62,130

Fair values for current financial assets and financial liabilities have not been disclosed because their carrying amount are a reasonable approximation of their fair values.

# Carrying amount includes current portion of debt shown under short term borrowing and excludes deferred payment liabilities.

Fair Value of borrowings does not include interest accrued but not due.

The Company had acquired certain equity instruments for purpose of holding for a longer duration and not for the purpose of selling in near term for short term profit. Such instruments have been categorized as FVTOCI.

(C) Derecognition of Investments in Equity Instruments designated at FVTOCI

(₹ in Crore)

	Year ended			
	31/03/2022		31/03/2021	
	Fair value on the date of derecognition	Cumulative gain or loss on disposal	Fair value on the date of derecognition	Cumulative gain or loss on disposal
<b>Investment in Equity Instrument- Quoted</b>				
National Aluminium Company Limited	388	303	-	-
<b>Total</b>	<b>388</b>	<b>303</b>	<b>-</b>	<b>-</b>

# Notes

forming part of the Consolidated Financial Statements

## B Fair Value Hierarchy

The following table shows the details of financial assets and financial liabilities, including their levels in the fair value hierarchy.

### (a) Financial assets and liabilities measured at fair value - Recurring fair value

(₹ in Crore)

	Note No.	As at					
		31/03/2022			31/03/2021		
		Level 1	Level 2	Level 3	Level 1	Level 2	Level 3
<b>Financial Assets</b>							
<b>Investments in Equity Instruments</b>	6A & 6B						
Quoted Equity Instruments		8,239	-	-	7,398	-	-
Unquoted Equity Instruments		-	-	48	-	-	30
<b>Investments in Preference Shares</b>	6A & 6B	-	24	-	-	25	-
<b>Investments in Debt Instruments</b>	6A & 6B	-	-	-	-	-	-
Mutual Funds		5,228	2	-	9,081	4	-
Bonds & Debentures		-	-	152	-	77	87
Government Securities		235	140	-	262	123	-
<b>Cash &amp; Cash Equivalents</b>	13						
Liquid Mutual Funds		662	-	-	769	-	-
<b>Trade Receivables</b>	12	-	736	-	-	287	-
<b>Derivatives</b>	46	-	3,671	-	-	1,751	-
<b>Other Financial Assets</b>	8A & 8B	-	-	380	-	-	819
<b>Total Financial Assets</b>		<b>14,364</b>	<b>4,573</b>	<b>580</b>	<b>17,510</b>	<b>2,267</b>	<b>936</b>
<b>Financial Liabilities</b>							
Derivatives	46	-	11,121	-	-	4,012	16
Trade Payables	20	-	5,073	-	-	4,771	-
<b>Total Financial Liabilities</b>		<b>-</b>	<b>16,194</b>	<b>-</b>	<b>-</b>	<b>8,783</b>	<b>16</b>

### (b) Financial assets and liabilities measured at amortised cost for which fair value disclosure is given

(₹ in Crore)

	Note No.	As at					
		31/03/2022			31/03/2021		
		Level 1	Level 2	Level 3	Level 1	Level 2	Level 3
<b>Financial Assets</b>							
Loans and Deposits	7 & 8A	-	-	428	-	-	340
<b>Financial Liabilities</b>							
Borrowings, Non-Current	18A	-	57,667	-	-	62,130	-

Level 1: Hierarchy includes financial instruments valued using quoted market prices. Listed equity instruments and traded debt instruments which are traded in the stock exchanges are valued using the closing price at the reporting date. Mutual funds are valued using the closing NAV.

Level 2: Hierarchy includes financial instruments that are not traded in active market. This includes over the counter (OTC) derivatives, close ended mutual funds and debt instruments valued using observable market data such as yield etc. of similar instruments traded in active market. All derivatives are reported at discounted values hence are included in Level 2. Borrowings have been fair valued using credit adjusted interest rate prevailing on the reporting date. Trade Receivables and Payables that are realigned based on forward LME/LBMA price movements have been included in Level 2 hierarchy.

Level 3: If one or more significant inputs is not based on observable market data, the instrument is included in level 3. This is the case for unlisted equity instruments and certain debt instruments which are valued using assumptions from market participants. Valuations for certain derivatives for which forward prices are not observable, have been valued using forward prices for a nearby geographical market and adjusted for historical spreads between cash prices of the two markets.

### (c) Disclosure of changes in level 3 items for the period ended 31/03/2022 and 31/03/2021 respectively

(₹ in Crore)

	Unquoted Equity Instruments	Unquoted Debt Instruments	Derivatives	Contingent Consideration	Total
<b>As at April 01, 2020</b>	<b>35</b>	<b>224</b>	<b>(48)</b>	<b>-</b>	<b>211</b>
Sale	-	(49)	(13)	-	(62)
Sale of Business	-	-	-	802	802
Gain/(losses) recognised in Profit or loss	-	2	42	20	64
Gain/(losses) recognised in OCI	(5)	-	2	-	(3)
Exchange difference	-	-	1	(3)	(2)
Transfer from Level 1 & 2	-	6	-	-	6
Transfer to Level 1 & 2	-	(96)	-	-	(96)
<b>As at March 31, 2021</b>	<b>30</b>	<b>87</b>	<b>(16)</b>	<b>819</b>	<b>920</b>
Acquisitions	22	-	-	-	22
Sale	-	(10)	(44)	-	(54)
Sale of Business	-	-	-	-	-
Gain/(losses) recognised in Profit or loss	-	8	47	-	55
Gain/(losses) recognised in OCI	(4)	-	13	-	9
Mark down to fair value	-	-	-	(454)	(454)
Exchange difference	-	-	-	15	15
Transfer from Level 1 & 2	-	67	-	-	67
Transfer to Level 1 & 2	-	-	-	-	-
<b>As at March 31, 2022</b>	<b>48</b>	<b>152</b>	<b>-</b>	<b>380</b>	<b>580</b>
Unrealised Gain/ (loss) recognised in profit and loss relating to assets and liabilities held at the end of reporting period:					
<b>As at March 31, 2022</b>	<b>-</b>	<b>-</b>	<b>9</b>	<b>-</b>	<b>9</b>
<b>As at March 31, 2021</b>	<b>-</b>	<b>-</b>	<b>5</b>	<b>-</b>	<b>5</b>

Transfers from level 1 and 2 to level 3 and out of level 3 for unquoted debt instruments is based on unavailability/availability of market observable inputs as on the reporting date. The Company's policy is to recognise transfers into and transfers out of fair value hierarchy levels as at the end of the reporting period.



# Notes

forming part of the Consolidated Financial Statements

## Valuation Process

Some of the Group’s assets and liabilities are measured at fair value for financial reporting purposes. The Management of the Group has set up a team in the finance department which performs the valuation of financial assets and liabilities.

In estimating the fair value of an asset or a liability, the Group uses market-observable data to the extent it is available. Where Level 1 inputs are not available, the Group engages third party qualified valuers to perform the valuation. The team works closely with the qualified external valuers to establish the appropriate valuation techniques and inputs to the model. The team reports findings to the Management of the Group to explain the cause of fluctuations in the fair value of the assets and liabilities.

### Valuation techniques used for valuation of instruments categorised as level 3.

For valuation of investments in equity shares which are unquoted, peer comparison has been performed wherever available. Valuation has been primarily done by considering the net worth of the Company and price to book multiple to arrive at the fair value. In cases where income approach was feasible valuation has been arrived using the earnings capitalisation method. For inputs that are not observable for these instruments, certain assumptions are made based on available information. The most significant of these assumptions are the discount rate and credit spreads used in the valuation process.

For valuation of investments in debt securities categorised as level 3, market polls which represent indicative yields are used as assumptions by market participants when pricing the asset.

Forward prices are not observable for Oswego, New York facility and electricity swaps which is derived based on forward prices of a geographically nearby market with adjustments for historical spreads of cash prices between the two markets. Valuations are adjusted for various factors such as liquidity, bid/offer spreads and credit considerations.

Contingent Consideration is recognised based on discounted value of amount estimated to be receivable. Discount rate used for determination are based on credit risk of the purchaser. Refer Note 50 on Discontinued Operations.

## 46. Financial Risk Management and Derivative Financial Instruments

Refer Note 1B(R) for accounting policy on Derivatives and Hedge Accounting

### A Financial Risk Management

The Group’s activities exposes it to various risks such as market risk, liquidity risk and credit risk. This section explains the risks which the Group is exposed to and how it manages the risks.

#### (a) Market Risk

##### i Commodity Price Risk

Hindalco’s India Operations consist of two businesses – Copper Business and Aluminium Business. The Copper Business works under a “Custom Smelting” model wherein the focus is to improve the processing margin. The timing mis-match risk between the input and output price, which is linked to the same international pricing benchmark, is eliminated through use of derivatives. This off-set hedge model (through use of derivatives) is used to manage the timing mis-match risk for both Commodity (Copper and Precious Metals) and Currency Risk (primarily, USD/INR). The Copper Business also has a portion of View Based exposure for both Commodity and Currency, beyond the above timing mis-match risk. Lower Copper Prices, Stronger USD/INR exchange rate and Higher “Other Input” Prices (eg. Coal, furnace oil, natural gas etc) are the major price risks that adversely impact the business. Here, the Company may use derivative instruments, wherever available, to manage these pricing risks. A variety of factors, including the risk appetite of the business and price view, are considered while taking Hedging Decisions. Such View based hedges are usually done for the next 1-8 quarters.

The Aluminium Business is a vertically integrated business model wherein the input and output pricing risks are independent of each other, i.e. – are on different pricing benchmarks, if any. Here, the Group may use derivative instruments, wherever available, to manage its pricing risks for both input and output products. Lower Aluminium Prices, Stronger USD/INR exchange rate and Higher Input Prices (e.g. Alumina, Furnace Oil, Coal, Electricity, Natural

Gas, Diesel Fuel) are the major price risks that adversely impact the business. Hedging decisions are based on a variety of factors, including risk appetite of the business and price View. Such Hedge decisions are usually done for the next 1-15 quarters.

### Embedded Derivatives

Copper concentrate is purchased on future pricing model based on month’s average LME (in case of copper) / LBMA (in case of gold and silver). Since, the value of the concentrate changes with response to change in commodity pricing indices, embedded derivatives (ED) is identified and segregated in the contract. The ED so segregated, is treated like commodity derivative and qualify for hedge accounting. These derivatives are put into a Fair Value hedge relationship with respect to inventory.

Novelis business model is conducted under a conversion model which allows us to pass through increases or decreases in the price of aluminium to our customers . Derivative instruments are used to preserve conversion margins and manage timing differences associated with metal price lag related to base aluminium price. Novelis also uses several sources of energy such as natural gas, electricity, fuel oil and transport oil in manufacturing and delivery of its products.

The table below summarises the gain/(loss) impact on account of increase in the commodity prices on the Group’s equity and profit for the period.

(₹ in Crore)

	Price Index	Increase in Rate/Price	Year ended			
			31/03/2022		31/03/2021	
			Change in Statement of Profit & Loss	Change in Other Components of Equity	Change in Statement of Profit & Loss	Change in Other Components of Equity
Aluminium	LME	10%	(34)	(2,528)	(45)	(1,325)
Copper	LME	10%	(847)	-	(686)	(24)
Gold	LBMA/ MCX	10%	(136)	-	(104)	-
Silver	LBMA	10%	(10)	-	(19)	-
Zinc	LME	10%	2	-	4	-
Local Market Premium	Midwest Premium/ European Duty Paid	10%	-	-	(2)	-
Coal	API IV	10%	-	-	-	-
Furnace Oil	AG Platts	10%	-	-	-	6
Electricity	National Grid/ NYMEX	10%	-	-	-	4
Natural Gas	ICE Brent/ Henry NYMEX	10%	1	29	1	18
Diesel Fuel	EIA Flat Tax On-Highway	10%	-	12	-	8

Decrease in prices by 10% will have equal and opposite impact in financial statements. Sensitivity analysis has been computed by stress testing the market price of the underlying price index on the outstanding derivative position as on the reporting date by assuming all other factors constant.

##### ii Foreign Currency Risk

Exchange rate movements, particularly the United States Dollar (USD) and Euro (EUR) against Indian Rupee (INR) and Euro, the Swiss franc, the Brazilian real and the Ko e portion of revenues are denominated in the Euro, the Group benefits as the franc weakens but is adversely affected as the franc strengthens. In South Korea, for local currency

# Notes

forming part of the Consolidated Financial Statements

operating costs and U.S. dollar denominated selling prices for exports, the Group benefits as the won weakens but are adversely affected as the won strengthens. In Brazil, where the Group has predominately U.S. dollar selling prices and local currency manufacturing costs, it benefits as the real weakens, but is adversely affected as the real strengthens.

The Group's exposure to foreign currency risk at the end of the reporting period expressed in INR, is as follows:

Currency Pair	Unhedged Foreign Currency Payable / (Receivable) (₹ in Crore)	
	As at	
	31/03/2022	31/03/2021
USD	-	29
GBP	281	(2)
NOK	1	1
CAD	19	12
AUD	-	-
CHF	348	11
BRL	-	(14)
JPY	(3)	(4)
	<b>646</b>	<b>33</b>

Assets and liabilities that are naturally hedged against future transactions are excluded for the purpose of above disclosure.

The table below summarises the gain/(loss) impact on account of increase/decrease in the exchange rates on the Group's equity and profit for the period.

Currency Pair	Increase in Rate/Price	Year ended (₹ in Crore)			
		31/03/2022		31/03/2021	
		Change in Statement of Profit & Loss	Change in Other Components of Equity	Change in Statement of Profit & Loss	Change in Other Components of Equity
USD_INR	10%	(13)	(1,158)	32	(1,110)
EUR_INR	10%	-	-	4	1
EUR_USD	10%	121	89	291	146
BRL_USD	10%	80	117	34	68
KRW_USD	10%	138	322	91	244
CAD_USD	10%	9	15	9	18
GBP_USD	10%	304	-	13	-
CHF_USD	10%	(27)	25	24	4
CNY_USD	10%	12	-	35	-
GBP_CHF	10%	6	-	6	-
EUR_CHF	10%	244	45	190	37
EUR_GBP	10%	170	-	137	-
EUR_CNY	10%	1	-	9	3
EUR_KRW	10%	1	1	1	2

Decrease in prices by 10% will have equal and opposite impact in financial statements. Sensitivity analysis has been computed by stress testing the market price of the underlying currency index on the outstanding derivative position and unhedged exposure as on the reporting date by assuming all other factors constant.

### iii Interest Rate Risk

a The Group is exposed to interest rate risk on financial liabilities such as borrowings, both short-term and long-term. It maintains a balance of fixed and floating interest rate borrowings and the proportion is determined by current market interest rates, projected debt servicing capability and view on future interest rates. Such interest rate risk is actively evaluated and interest rate swap is taken whenever considered necessary.

The Group is also exposed to interest rate risk on its financial assets that include fixed deposits, bonds, debentures, commercial paper, mutual funds and liquid investments comprising mainly mutual funds (which are part of cash and cash equivalents). Since, all these are generally for short durations, the Group believes it has manageable and limited interest rate risk.

The table below summarises the (gain)/loss impact on account of increase in the benchmark interest rates on the Group's equity and profit for the period.

	Increase in Rate/Price	Year ended (₹ in Crore)			
		31/03/2022		31/03/2021	
		Change in Statement of Profit & Loss	Change in Other Components of Equity	Change in Statement of Profit & Loss	Change in Other Components of Equity
Interest rate on floating rate borrowings	100 bps	(193)	-	(210)	-

Decrease in rates by 100 bps will have equal and opposite impact in financial statements.

### b Interbank Offered Rates (IBOR) Reform

The following table contains details of all financial instruments that are referenced to IBOR which have not yet transitioned to an alternative interest rate benchmark (ARR):

Non-derivative assets and liabilities	IBOR Exposure	Carrying Value (₹ in Crore)	Alternative Interest Rate Benchmark
Long Term Foreign Currency Borrowings	USD 1M-6M LIBOR	9,371	Secured Overnight funding Rate (SOFR)
Short Term Foreign Currency Borrowings	USD 1M LIBOR	114	

### Derivatives

The Group does not have any interest rate hedges outstanding as on the reporting date, accordingly IBOR related impact on hedge accounting including discounting of other derivatives is not expected to be material.

### iv Equity Price Risk

The Group's exposure to equity securities price risk arises from movement in market price of related securities classified either as fair value through OCI or as fair value through profit and loss. The Group manages the price risk through diversified portfolio.

The table below summarises the gain/(loss) impact on account of increase in the equity share prices on the Group's equity and profit for the period.

	Increase in Rate/Price	Year ended (₹ in Crore)			
		31/03/2022		31/03/2021	
		Change in Statement of Profit & Loss	Change in Other Components of Equity	Change in Statement of Profit & Loss	Change in Other Components of Equity
Investment in Equity securities	10%	-	728	-	656

Decrease in prices by 10% will have equal and opposite impact in financial statements. Sensitivity analysis has been computed by stress testing the market price of the underlying price index on the investment portfolio as on the reporting date.

# Notes

forming part of the Consolidated Financial Statements

## (b) Liquidity Risk

The Group determines its liquidity requirements in the short, medium and long term. This is done by drawing up cash forecast for short and medium term requirements and strategic financing plans for long term needs.

The Group manages its liquidity risk in a manner so as to meet its normal financial obligations without any significant delay or stress. Such risk is managed through ensuring operational cash flow while at the same time maintaining adequate cash and cash equivalent position. The management has arranged for diversified funding sources and adopted a policy of managing assets with liquidity in mind and monitoring future cash flows and liquidity on a regular basis. Surplus funds not immediately required are invested in certain investments (including mutual fund) which provide flexibility to liquidate at short notice and are included in current investments and cash and cash equivalents. Besides, it generally has certain undrawn credit facilities which can be accessed as and when required; such credit facilities are reviewed periodically.

The Group has developed appropriate internal control systems and contingency plans for managing liquidity risk. This incorporates an assessment of expected cash flows and availability of alternative sources for additional funding, if required.

## (i) Financing Arrangement

The Group had access to the following undrawn borrowing facilities at the end of the reporting period:

	As at	
	As at 31/03/2022	31/03/2021
Bank Overdraft and other facilities	15,197	10,734

Undrawn limit has been calculated based on the available drawing power and sanctioned amount at each reporting date.

## (ii) Maturity Analysis

The table below shows the Group's financial liabilities into relevant maturity groupings based on their contractual maturities for all non-derivative financial liabilities and net settled derivative financial instruments. The amounts disclosed in the table are the contractual undiscounted cash flows. Balances due within 12 months equal their carrying balances as the impact of discounting is not significant.

	As at					
	Less than 1 Year	Between 1 and 2 Years	Between 2 and 5 Years	Over 5 Years	Total	Carrying Value
<b>Contractual maturities of financial liabilities as at March 31, 2022</b>						
Non Derivatives						
Borrowings #	14,132	3,099	23,001	39,516	79,748	63,235
Lease liabilities	348	360	461	1,042	2,211	1,251
Supplier's credit	2,459	-	-	-	2,459	2,456
Trade payables	41,382	-	-	-	41,382	41,382
Other financial liabilities	3,607	13	-	126	3,746	3,746
<b>Total Non Derivative Liabilities</b>	<b>61,928</b>	<b>3,472</b>	<b>23,462</b>	<b>40,684</b>	<b>129,546</b>	<b>112,070</b>
Derivatives	10,649	464	10	-	11,123	11,121
<b>Total Derivative Liabilities</b>	<b>10,649</b>	<b>464</b>	<b>10</b>	<b>-</b>	<b>11,123</b>	<b>11,121</b>

	As at					
	Less than 1 Year	Between 1 and 2 Years	Between 2 and 5 Years	Over 5 Years	Total	Carrying Value
<b>Contractual maturities of financial liabilities as at March 31, 2021</b>						
Non Derivatives						
Borrowings #	9,235	15,625	13,505	44,402	82,767	65,978
Lease liabilities	357	244	433	725	1,759	1,228
Supplier's credit	255	-	-	-	255	255
Trade payables	28,235	-	-	-	28,235	28,235
Other financial liabilities	2,531	10	-	123	2,664	2,664
<b>Total Non Derivative liabilities</b>	<b>40,613</b>	<b>15,879</b>	<b>13,938</b>	<b>45,250</b>	<b>115,680</b>	<b>98,360</b>
Derivatives	3,603	400	28	4,031	4,028	
<b>Total Derivative liabilities</b>	<b>3,603</b>	<b>400</b>	<b>28</b>	<b>-</b>	<b>4,031</b>	<b>4,028</b>

# Includes Principal and interest payments, short term borrowings, current portion of debt and excludes unamortised fees.

Total cash outflow for leases for year ended 31/03/2022 is ₹ 720 crore (31/03/2021: is ₹ 631 crore), includes ROU Lease payment, Short term lease and Low value lease - (refer note 18A(g) and 36).

## (c) Credit Risk

Credit risks is the risk of financial loss to the Group if a customer or counterparty to a financial instrument fails to meet its contractual obligation, and arises principally from the Group's receivables from customers.

Credit risk arises from cash and cash equivalents, contractual cash flows of debt investments, favourable derivative financial instruments and deposits with banks and financial institutions, as well as credit exposures to customers including outstanding receivables.

Credit risk is managed on an group basis. The Group has adopted a policy of dealing only with creditworthy counterparties and obtaining sufficient collateral, where appropriate, as a means of mitigating risk of financial loss from defaults. The Group invests only in those instruments issued by high rated banks/ institutions and government agencies. The Group assesses the credit quality of the customer, taking into account its financial position, past experience and other factors. The Group's investments in debt instruments and certain loans are considered as low risk investments. The credit ratings of the investments are monitored for credit deterioration.

For some trade receivables the Group obtains security in the form of guarantees, deed of undertaking or letters of credit which can be called upon if the counterparty is in default under the terms of the agreement.

For other financial assets, the Group assesses and manages credit risk based on the credit rating. The Group has assessed its other financial assets as high quality, negligible credit risk. The Group periodically monitors the recoverability and credit risks of its other financials assets including security deposits and other receivables. The Group evaluates 12 month expected credit losses for all the financial assets for which credit risk has not increased. In case credit risk has increased significantly, the Group considers life time expected credit losses for the purpose of impairment provisioning.

The Group has used a practical expedient by computing the expected credit loss allowance for trade receivables based on a provision matrix. The provision matrix takes into account historical credit loss experience and adjusted for forward-looking information.



# Notes

forming part of the Consolidated Financial Statements

Movement in the allowance for doubtful debts :

	As at	
	31/03/2022	31/03/2021
Balance at beginning of the year	(77)	(109)
Impairment losses (recognised)/ reversed on receivables	(10)	32
Amounts written off during the period as uncollectible	3	-
Foreign exchange translation gains and losses	-	-
<b>Balance at end of the year</b>	<b>(84)</b>	<b>(77)</b>

## B Derivative Financial Instruments

The Group uses derivative financial instruments such as forwards, futures, swaps, options etc. to hedge its risks associated with foreign exchange fluctuation. Risks associated with fluctuation in the price of the products (copper, aluminium, coal, furnace oil, natural gas, electricity, diesel and precious metals) are minimized by undertaking appropriate derivative instruments. Derivatives embedded in other contracts are treated as separate derivatives when their risks and characteristics are not closely related to their host contracts. In some cases, the embedded derivatives may be designated in a hedge relationship. The fair values of all such derivative financial instruments are recognized as assets or liabilities at the balance sheet date.

The Group also applies hedge accounting using certain foreign currency non-derivative monetary items which are used as hedging instruments for hedging foreign exchange risk.

(a) The Asset and Liability position of various outstanding derivative financial instruments is given below:

Current	Nature of Risk being Hedged	As at			
		31/03/2022		31/03/2021	
		Liability	Asset	Liability	Asset
<b>Cash flow hedges</b>					
Commodity contracts	Price Risk	(6,829)	257	(1,730)	72
Foreign currency contracts	Exchange rate movement risk	(220)	441	(147)	179
<b>Fair value Hedges</b>					
Commodity contracts	Price Risk	(175)	59	(99)	285
Foreign currency contracts	Exchange rate movement risk	(12)	1	(10)	-
Embedded derivatives (i)	Price Risk	(489)	5	(411)	120
<b>Non-designated hedges</b>					
Commodity contracts	Price Risk	(3,226)	2,435	(1,405)	797
Foreign currency contracts	Exchange rate movement risk	(195)	172	(210)	162
<b>Total</b>		<b>(11,146)</b>	<b>3,370</b>	<b>(4,012)</b>	<b>1,615</b>
<b>Non - current</b>					
<b>Cash flow hedges</b>					
Commodity contracts	Price Risk	(442)	51	(391)	10
Foreign currency contracts	Exchange rate movement risk	(5)	235	(31)	224
<b>Non-designated hedges</b>					
Commodity contracts	Price Risk	(16)	18	(5)	22
Foreign currency contracts	Exchange rate movement risk	(1)	1	-	-
<b>Total</b>		<b>(464)</b>	<b>305</b>	<b>(427)</b>	<b>256</b>
<b>Grand Total</b>		<b>(11,610)</b>	<b>3,675</b>	<b>(4,439)</b>	<b>1,871</b>

(i) Fair Value net Loss of Embedded Derivatives of ₹ (484) crore (31/03/2021: net Loss ₹ 291 crore) accounted for as part of Trade Payables.

(b) Outstanding position and fair value of various foreign exchange derivative financial instruments:

	Currency Pair	As at					
		31/03/2022			31/03/2021		
		Average exchange rate	Notional Value (in Million)	Fair Value Gain/ (Loss) (₹ Crore)	Average exchange rate	Notional Value (in Million)	Fair Value Gain/ (Loss) (₹ Crore)
<b>Foreign Currency Forwards</b>							
<b>Cash flow hedges</b>							
Buy	CHF_EUR	0.94	93	30	0.93	68	(13)
Buy	USD_CHF	0.91	27	-	0.89	3	(1)
Buy	BRL_USD	0.17	275	245	0.18	223	(91)
Buy	EUR_USD	1.18	219	(72)	1.21	116	(19)
Buy	USD_CAD	1.25	24	-	1.28	28	4
Buy	USD_KRW	1,176.23	657	(131)	1,129.30	490	(12)
Buy	EUR_CNY	-	-	-	7.91	4	-
Buy	EUR_INR	-	-	-	90.82	1	-
Buy	EUR_KRW	-	1	-	-	4	-
Sell	USD_INR	81.22	1,196	380	81.45	1,069	357
<b>Total</b>				<b>452</b>			<b>225</b>
<b>Fair value hedges</b>							
Buy	USD_INR	76.85	189	(11)	74.45	159	(10)
<b>Total</b>				<b>(11)</b>			<b>(10)</b>
<b>Non-Designated</b>							
Buy	EUR_INR	98.96	0	-	88.57	8	(1)
Buy	GBP_INR	-	-	-	98.46	0	-
Buy	USD_INR	77.04	0	-	72.98	28	1
Buy	GBP_EUR	1.19	269	(12)	1.14	214	39
Buy	USD_KRW	1,198.22	282	(21)	1,108.75	184	(29)
Buy	EUR_USD	1.19	290	(65)	1.33	232	(49)
Buy	GBP_USD	1.35	33	6	1.35	19	(3)
Buy	USD_CHF	0.92	9	-	0.89	17	(6)
Buy	CAD_USD	0.80	16	1	0.72	16	11
Buy	USD_BRL	4.89	187	27	5.88	107	9
Buy	EUR_KRW	-	2	-	-	2	-
Buy	CHF_GBP	0.82	9	(1)	0.78	9	1
Buy	CHF_EUR	0.98	503	32	0.95	345	(17)
Buy	USD_CNY	6.32	77	3	6.84	99	(1)
Buy	EUR_CNY	7.33	2	-	8.04	12	(1)
Buy	SGD_INR	-	-	-	55.85	1	-
Sell	USD_INR	76.35	182	7	73.07	51	(2)
<b>Total</b>				<b>(23)</b>			<b>(48)</b>
<b>Grand Total</b>				<b>418</b>			<b>167</b>

# Notes

forming part of the Consolidated Financial Statements

(c) Outstanding position and fair value of various foreign exchange non-derivative financial instruments used as hedging instruments:

	Note No.	Currency Pair	As at					
			31/03/2022			31/03/2021		
			Average exchange rate	Notional Value (in Million)	Fair Value Gain/ (Loss) (₹ in Crore)	Average exchange rate	Notional Value (in Million)	Fair Value Gain/ (Loss) (₹ in Crore)
<b>Foreign currency monetary items</b>								
<b>Cash flow hedges</b>								
Debt	18B	USD_INR	74.55	185	(25)	73.13	580	11
<b>Liability for Copper Concentrate</b>								
Host Liability		USD_INR	75.51	695	(19)	72.84	680	(19)
Supplier Credit	19	USD_INR	74.77	324	(39)			
<b>Total</b>					<b>(83)</b>			<b>(8)</b>

(d) Outstanding position and fair value of various commodity derivative financial instruments

i Outstanding position and fair value of various commodity derivative financial instruments as at March 31, 2022:

		Currency	Average Price/ Unit	Quantity	Unit	Notional value (in Million)	Fair Value Gain/ (Loss) (₹ in Crore)
<b>Commodity Futures/Forwards/Swaps</b>							
<b>Cash Flow Hedge</b>							
Aluminium	Sell	USD	3,165	1,366,316	MT	4,234	(7,199)
Aluminium	Buy	USD	3,481	6,074	MT	21	20
Copper	Sell	USD	-	-	MT	-	-
Furnace Oil	Buy	USD	-	-	MT	-	-
Diesel Fuel	Buy	USD	5	4,014,924	Gallons	21	26
Natural gas	Buy	USD	6	10,596,346	MMBtu	59	190
Electricity	Buy	USD	-	-	Mwh	-	-
<b>Total</b>							<b>(6,963)</b>
<b>Fair Value Hedge</b>							
Gold	Sell	INR	4,972,320	7,543	KGS	37,506	(159)
Silver	Sell	USD	23	485,904	TOZ	11	(7)
Copper	Sell	USD	10,552	37,600	MT	397	50
<b>Total</b>							<b>(116)</b>
<b>Non-Designated</b>							
Aluminium	Buy	USD	3,502	98,034	MT	343	186
Aluminium	Sell	USD	3,041	115,141	MT	350	(1,235)
Copper	Buy	USD	10,160	27,875	MT	283	62
Copper	Sell	USD	10,763	35,500	MT	382	105
Gold	Buy	INR	5,041,209	4,352	KGS	21,939	51
Silver	Buy	USD	25	244,244	TOZ	6	-

		Currency	Average Price/ Unit	Quantity	Unit	Notional value (in Million)	Fair Value Gain/ (Loss) (₹ in Crore)
Silver	Sell	USD	24	244,244	TOZ	6	(1)
Furnace Oil	Buy	USD	240	3,335	MT	1	10
Furnace Oil	Sell	USD	636	3,335	MT	2	-
Local Market Premiums	Sell	USD	-	-	MT	-	-
Local Market Premiums	Buy	USD	-	-	MT	-	-
Zinc	Buy	USD	4,135	950	MT	4	13
Diesel Fuel	Buy	USD	-	-	Gallons	-	-
Diesel Fuel	Buy	USD	5	3,600	MT	0	9
Natural Gas	Buy	USD	6	581,486	MMBtu	3	11
<b>Total</b>							<b>(789)</b>

**Commodity Options**

<b>Cash Flow Hedge</b>							
Aluminium	Sell	USD	-	-	MT	-	-
<b>Total</b>							<b>-</b>

**Embedded derivatives**

<b>Fair Value Hedge</b>							
Copper	Sell	USD	9,838	120,552	MT	1,186	(487)
Gold	Sell	USD	1,949	29,697	TOZ	58	2
Silver	Sell	USD	25	371,143	TOZ	9	-
<b>Total</b>							<b>(485)</b>
<b>Grand Total</b>							<b>(8,353)</b>

ii Outstanding position and fair value of various commodity derivative financial instruments as at March 31, 2021:

		Currency	Average Price/ Unit	Quantity	Unit	Notional value (in Million)	Fair Value Gain/ (Loss) (₹ in Crore)
<b>Commodity Futures/Forwards/Swaps</b>							
<b>Cash Flow Hedge</b>							
Aluminium	Sell	USD	2,051	1,140,878	MT	2,340	(2,058)
Aluminium	Buy	USD	2,188	9,564	MT	21	20
Copper	Sell	USD	8,332	5,875	MT	49	(19)
Furnace Oil	Buy	USD	223	40,000	MT	9	33
Diesel Fuel	Buy	USD	3	4,788,000	Gallons	15	5
Natural gas	Buy	USD	3	12,900,000	MMBtu	34	3
Electricity	Buy	USD	28	226,420	Mwh	6	(16)
<b>Total</b>							<b>(2,032)</b>

# Notes

forming part of the Consolidated Financial Statements

		Currency	Average Price/ Unit	Quantity	Unit	Notional value (in Million)	Fair Value Gain/ (Loss) (₹ in Crore)
<b>Fair Value Hedge</b>							
Gold	Sell	INR	4,841,222	7,109	KGS	34,416	260
Silver	Sell	USD	25	1,032,196	TOZ	26	2
Copper	Sell	USD	8,564	46,325	MT	397	(76)
<b>Total</b>							<b>186</b>
<b>Non-Designated</b>							
Aluminium	Buy	USD	2,181	160,664	MT	350	162
Aluminium	Sell	USD	1,994	197,499	MT	394	(616)
Copper	Buy	USD	8,899	34,450	MT	307	18
Copper	Sell	USD	8,544	38,725	MT	331	(71)
Gold	Buy	INR	4,633,701	4,608	KGS	21,352	(78)
Silver	Buy	USD	26	1,037,171	TOZ	27	(12)
Silver	Sell	USD	24	1,162,387	TOZ	28	(5)
Furnace Oil	Buy	USD	271	7,446	MT	2	5
Furnace Oil	Sell	USD	373	7,446	MT	3	-
Local Market Premiums	Sell	USD	225	11,250	MT	3	(2)
Local Market Premiums	Buy	USD	468	75	MT	-	-
Zinc	Buy	USD	2,795	2,550	MT	7	9
Diesel Fuel	Buy	USD	3	252,000	Gallons	-	-
Natural Gas	Buy	USD	3	420,000	MMBtu	1	(1)
<b>Total</b>							<b>(591)</b>
<b>Commodity Options</b>							
<b>Cash Flow Hedge</b>							
Aluminium	Sell	USD	2,200	45,000	MT	99	(7)
<b>Total</b>							<b>(7)</b>
<b>Embedded derivatives</b>							
<b>Fair Value Hedge</b>							
Copper	Sell	USD	8,434	113,831	MT	960	(302)
Gold	Sell	USD	1,724	38,284	TOZ	66	5
Silver	Sell	USD	26	498,103	TOZ	13	6
<b>Total</b>							<b>(291)</b>
<b>Grand Total</b>							<b>(2,735)</b>

(e) The following table presents details of amount held in Effective portion of Cash Flow Hedge and Cost of Hedging Reserve and the period during which these are going to be released and affecting Statement of Profit and Loss.

(₹ in Crore)

Cash Flow Hedge	Products/ Currency Pair	As at					
		31/03/2022			31/03/2021		
		Closing Value Cash Flow Hedges	Release		Closing Value Cash Flow Hedges	Release	
Gain/(Loss)	Within 12 Months	After 12 Months	Gain/(Loss)	Within 12 Months	After 12 Months	Gain/(Loss)	
<b>Hedge Instrument Type</b>							
Commodity Forwards	Aluminium	(7,500)	(7,315)	(185)	(2,154)	(1,847)	(307)
	Copper	-	-	-	(19)	(19)	-
	Furnace Oil	-	-	-	33	33	-
	Diesel Fuel	23	23	-	2	2	-
	Electricity	(1)	(1)	-	(30)	(30)	-
	Natural Gas	199	140	59	-	(5)	5
<b>Total</b>		<b>(7,279)</b>	<b>(7,153)</b>	<b>(126)</b>	<b>(2,168)</b>	<b>(1,866)</b>	<b>(302)</b>
<b>Non derivative financial instruments</b>							
Debt	USD_INR	(25)	(25)	-	11	11	-
Liability for Copper		-	5	5	-	-	-
Host Liability	USD_INR	(29)	(29)	-	-	-	-
Supplier credit	USD_INR	(39)	(39)	-	-	-	-
<b>Total</b>		<b>(93)</b>	<b>(93)</b>	<b>-</b>	<b>16</b>	<b>16</b>	<b>-</b>
<b>Hedge Instrument Type</b>							
Currency Forwards	USD_INR	379	207	172	357	134	223
	EUR_INR	-	-	-	-	-	-
	USD_EUR	(74)	(74)	-	(12)	(12)	-
	USD_BRL	242	169	73	(103)	(55)	(48)
	USD_CAD	-	-	-	4	4	-
	USD_KRW	(132)	(133)	1	(12)	-	(12)
	USD_CHF	(1)	(1)	-	(1)	(1)	-
	EUR_CHF	33	31	2	(15)	(15)	-
	EUR_CNY	-	-	-	-	-	-
Currency Swaps	USD_INR	-	-	-	-	-	-
<b>Total</b>		<b>447</b>	<b>199</b>	<b>248</b>	<b>218</b>	<b>55</b>	<b>163</b>
<b>Total</b>		<b>(6,925)</b>	<b>(7,047)</b>	<b>122</b>	<b>(1,934)</b>	<b>(1,795)</b>	<b>(139)</b>
Deferred Tax on above		2,031	2,070	(39)	688	545	143
		<b>(4,894)</b>	<b>(4,977)</b>	<b>83</b>	<b>(1,246)</b>	<b>(1,250)</b>	<b>4</b>



# Notes

forming part of the Consolidated Financial Statements

(₹ in Crore)

	Products/ Currency Pair	As at					
		31/03/2022			31/03/2021		
		Closing Value Cost of Hedge Reserve	Release		Closing Value Cost of Hedge Reserve	Release	
			Within 12 Months	After 12 Months		Within 12 Months	After 12 Months
Gain/(Loss)	Gain/(Loss)	Gain/(Loss)	Gain/(Loss)	Gain/(Loss)	Gain/(Loss)		
<b>Cost of Hedging Reserve</b>							
<b>Hedge Instrument Type</b>							
Commodity Forwards	Silver	-	-	-	-	-	
	Copper	(60)	(60)	-	22	22	
Commodity Options	Aluminium	-	-	-	(7)	(7)	
Currency Swaps	USD_INR	-	-	-	-	-	
Currency Options	USD_INR	-	-	-	-	-	
<b>Total</b>		<b>(60)</b>	<b>(60)</b>	<b>-</b>	<b>15</b>	<b>15</b>	
Deferred Tax on above		21	21	-	(5)	(5)	
		<b>(39)</b>	<b>(39)</b>	<b>-</b>	<b>10</b>	<b>10</b>	

- (f) The following tables presents the amount of gain/(loss) recognized in Effective portion of Cash Flow Hedge and Cost of Hedging Reserve and recycled during the financial year 2021-22:

(₹ in Crore)

	Opening Balance	Net Amount recognised	Net Amount to P&L	Amount added to Non-Financial Assets	Total Amount recycled	CTA	Closing Balance
<b>Cash Flow Hedges</b>							
Commodity	(2,168)	(11,726)	(6,742)	80	(6,662)	(47)	(7,279)
Forex	234	(23)	(141)	(1)	(142)	2	354
<b>Total</b>	<b>(1,934)</b>	<b>(11,749)</b>	<b>(6,883)</b>	<b>79</b>	<b>(6,804)</b>	<b>(45)</b>	<b>(6,925)</b>
Deferred Tax on above	688	3,397	1,995	72	2,067	12	2,030
<b>Total</b>	<b>(1,246)</b>	<b>(8,352)</b>	<b>(4,888)</b>	<b>151</b>	<b>(4,737)</b>	<b>(33)</b>	<b>(4,894)</b>
<b>Cost of Hedging Reserve</b>							
Commodity	15	(360)	(285)	-	(285)	-	(60)
Forex	-	-	-	-	-	-	-
<b>Total</b>	<b>15</b>	<b>(360)</b>	<b>(285)</b>	<b>-</b>	<b>(285)</b>	<b>-</b>	<b>(60)</b>
Deferred Tax on above	(5)	124	98	-	98	-	21
<b>Total</b>	<b>10</b>	<b>(236)</b>	<b>(187)</b>	<b>-</b>	<b>(187)</b>	<b>-</b>	<b>(39)</b>

The following tables presents the amount of gain/(loss) recognized in Effective portion of Cash Flow Hedge and recycled during the financial year 2020-21:

(₹ in Crore)

	Opening Balance	Net Amount recognised	Net Amount to P&L	Amount added to Non-Financial Assets	Total Amount recycled	CTA	Closing Balance
<b>Cash Flow Hedges</b>							
Commodity	1,033	(4,369)	(1,169)	11	(1,158)	10	(2,168)
Forex	(1,343)	989	(442)	(137)	(579)	9	234
<b>Total</b>	<b>(310)</b>	<b>(3,380)</b>	<b>(1,611)</b>	<b>(126)</b>	<b>(1,737)</b>	<b>19</b>	<b>(1,934)</b>
Deferred Tax on above	180	978	477	(16)	461	(9)	688
<b>Total</b>	<b>(130)</b>	<b>(2,402)</b>	<b>(1,134)</b>	<b>(142)</b>	<b>(1,276)</b>	<b>10</b>	<b>(1,246)</b>
<b>Cost of Hedging Reserve</b>							
Commodity	1	48	34	-	34	-	15
Forex	182	7	189	-	189	-	-
<b>Total</b>	<b>183</b>	<b>55</b>	<b>223</b>	<b>-</b>	<b>223</b>	<b>-</b>	<b>15</b>
Deferred Tax on above	(64)	(19)	(78)	-	(78)	-	(5)
<b>Total</b>	<b>119</b>	<b>36</b>	<b>145</b>	<b>-</b>	<b>145</b>	<b>-</b>	<b>10</b>

- (g) The following table presents the amount of gain/ (loss) recycled from Effective portion of Cash Flow Hedge and Cost of Hedging Reserve and reference of the line item in the Statement of Profit and Loss where those amounts are included:

(₹ in Crore)

	Year ended	
	31/03/2022	31/03/2021
Revenue from Operations	(7,219)	(882)
Cost of Materials Consumed	206	(509)
Other Expenses	(155)	3
<b>Total</b>	<b>(7,168)</b>	<b>(1,388)</b>

- (h) The adjustment as part of the carrying value of inventories arising on account of fair value hedges is as follows:

(₹ in Crore)

Increase/ (Decrease) in Inventory Value	As at					
	31/03/2022			31/03/2021		
	Raw Material	WIP and Finished Goods	Total	Raw Material	WIP and Finished Goods	Total
Copper	487	(48)	439	302	93	395
Gold	(2)	69	67	(5)	(54)	(59)
Silver	-	6	6	(6)	(5)	(11)
<b>Total</b>	<b>485</b>	<b>27</b>	<b>512</b>	<b>291</b>	<b>34</b>	<b>325</b>

The Group's hedging policy only allows for effective hedge relationships to be established. The effective portion of hedge is recognised in OCI, while ineffective portion of hedge is recognised immediately in the Statement of Profit and Loss. For Cash flow hedges, the Group uses hypothetical derivative method to assess effectiveness based on "lower off" assessment.

# Notes

forming part of the Consolidated Financial Statements

Sources of Hedge ineffectiveness summarised by risk category are as follows :

Risk Category	Sources of Hedge Ineffectiveness	Type of Hedge
Price Risk	Critical terms Mismatch	Cash Flow and Fair Value Hedge
Basis Risk	Fair Value Hedge	
Credit Risk Adjustment	Cash Flow and Fair Value Hedge	
Exchange Risk	Credit Risk Adjustment	Cash Flow Hedge

The amount of gain/ (loss) recognised in the Statement of Profit and Loss on account of hedge ineffectiveness is as follows:

Note No.	Note Description	Particulars	Type of Hedge	Year ended	
				31/03/2022	31/03/2021
36	Other Expenses	Gain/(Loss) on Derivatives	Cash Flow Hedge	(1,001)	(316)
36	Other Expenses	Gain/(Loss) on Derivatives	Fair Value Hedge	(130)	(33)
				<b>(1,131)</b>	<b>(349)</b>

(₹ in Crore)

- (i) Certain hedges of forecast sale transaction for hedging currency risk were discontinued during the year since the hedged forecast transaction was not expected to occur.

## 47. Offsetting

Refer Note 1B(Q) for accounting policy on Financial Instruments

Financial instruments subject to offsetting , enforceable master netting arrangement and similar arrangement.

(₹ in Crore)

As at March 31, 2022:	Effects on Balance sheet			Related amounts not offset		
	Gross amount	Gross amount set off in the balance sheet	Net amount in the balance sheet	Amounts subject to master netting	Financial Instrument collateral	Net Amount
<b>Financial Assets</b>						
Derivatives	3,695	(24)	3,671	(1,792)	-	1,879
<b>Financial Liabilities</b>						
Derivatives	11,145	(24)	11,121	(1,792)	(345)	8,984

(₹ in Crore)

As at March 31, 2021:	Effects on Balance sheet			Related amounts not offset		
	Gross amount	Gross amount set off in the balance sheet	Net amount in the balance sheet	Amounts subject to master netting	Financial Instrument collateral	Net Amount
<b>Financial Assets</b>						
Derivatives	1,832	(81)	1,751	(593)	-	1,158
<b>Financial Liabilities</b>						
Derivatives	4,108	(80)	4,028	(593)	(267)	3,168

## 48. Interest in Other Entities

### A. Subsidiaries:

The Group's wholly-owned subsidiaries along with country of incorporation, place of operation and principal activities for the year ended March 31, 2022 and March 31, 2021 are set out below.

Name of Entity	Principal Activity	Country of Incorporation	Place of Operation
Minerals & Minerals Limited	Mining	India	India
Renukeshwar Investments & Finance Limited	Investment	India	India
Renuka Investments & Finance Limited	Investment	India	India
Lucknow Finance Company Limited	Investment	India	India
Dahej Harbour and Infrastructure Limited	Cargo services	India	India
Utkal Alumina International Limited	Manufacturing	India	India
Utkal Alumina Social Welfare Foundation	Welfare	India	India
Kosala Livelihood And Social Foundation	Welfare	India	India
Birla Copper Asoj Private Limited (formerly known as "Ryker Base Private Limited") - (g)	Manufacturing	India	India
AV Minerals (Netherlands) N.V.	Investment	Netherland	Netherland
Hindalco Do Brasil Industria Comercia de Alumina Ltda. - (f)	Subsidiary	Brazil	Brazil
AV Metals Inc.	Investment	Canada	Canada
Novelis Inc.	Manufacturing	Canada	Canada
Novelis do Brasil Ltda.	Manufacturing	Brazil	Brazil
Brecha Energetica Ltda.	Distribution Services	Brazil	Brazil
4260848 Canada Inc.	Management Company	Canada	Canada
4260856 Canada Inc.	Management Company	Canada	Canada
8018227 Canada Inc.	Management Company	Canada	Canada
Novelis (China) Aluminum Products Co., Ltd.	Manufacturing	China	China
Novelis (Shanghai) Aluminum Trading Co., Ltd.	Import and export aluminum	China	China
Novelis PAE SAS	Engineering	France	France
Novelis Aluminium Beteiligungs GmbH	Dormant	Germany	Germany
Novelis Deutschland GmbH (formerly known as "Aleris Deutschland Holding GmbH")	Manufacturing	Germany	Germany
Novelis Sheet Ingot GmbH	Manufacturing	Germany	Germany
Novelis (India) Infotech Ltd.	Dormant	India	India
Novelis Aluminum Holding Unlimited Company	Intermediate subsidiary	Ireland	Ireland
Novelis Italia SpA	Manufacturing	Italy	Italy
Novelis de Mexico S.A. de C.V.	Dormant	Mexico	Mexico
Novelis Korea Limited	Manufacturing	South Korea	South Korea
Novelis AG	Management Company	Switzerland	Switzerland
Novelis Switzerland S.A.	Manufacturing	Switzerland	Switzerland
Novelis MEA Ltd.	Import and export aluminum	UAE	UAE
Novelis Europe Holdings Limited	Intermediate subsidiary	UK	UK
Novelis UK Ltd.	Manufacturing	UK	UK
Novelis Services Limited	Management Company	UK	UK
Novelis Corporation	Manufacturing	USA	USA
Novelis South America Holdings LLC	Intermediate subsidiary	USA	USA
Novelis Holdings Inc.	Intermediate subsidiary	USA	USA

# Notes

forming part of the Consolidated Financial Statements

Name of Entity	Principal Activity	Country of Incorporation	Place of Operation
Novelis Services (North America) Inc.	Cash management service provider	USA	USA
Novelis Global Employment Organization, Inc.	Management Company	USA	USA
Novelis Services (Europe) Inc.	Management Company	USA	USA
Novelis Vietnam Company Limited	Manufacturing	Vietnam	Vietnam
Aleris Asia Pacific International (Barbados) Ltd.	Holding Company	Barbados	Barbados
Aleris Aluminum (Zhenjiang) Co., Ltd.	Manufacturing	China	China
Aleris (Shanghai) Trading Co., Ltd.	Management Company	China	China
Aleris Asia Pacific Limited	Holding Company	Hong Kong	Hong Kong
Aleris Aluminum Japan, Ltd.	Sales Office	Japan	Japan
Novelis Casthouse Germany GmbH (formerly known as "Aleris Casthouse Germany GmbH")	Manufacturing	Germany	Germany
Novelis Deutschland Holding GmbH	Holding Company	Germany	Germany
Novelis Koblenz GmbH (formerly known as "Aleris Rolled Products Germany GmbH")	Manufacturing	Germany	Germany
Novelis Netherlands B.V. (formerly known as "Novelis Aluminum Netherlands B.V.")	Management Company	Netherlands	Netherlands
Aleris Switzerland GmbH	Management Company	Switzerland	Switzerland
Aleris Aluminum UK Limited	Sales Office	UK	UK
Aleris Holding Canada ULC	Holding Company	Canada	Canada
Novelis ALR Aluminum Holdings Corporation (formerly known as "Aleris Corporation")	Manufacturing	USA	USA
Novelis ALR International, Inc. (formerly known as "Aleris International, Inc.")	Manufacturing	USA	USA
Novelis ALR Rolled Products, LLC (formerly known as "Aleris Rolled Products, LLC")	Management Company	USA	USA
Novelis ALR Rolled Products, Inc. (formerly known as "Aleris Rolled Products, Inc.")	Management Company	USA	USA
Novelis ALR Aluminum, LLC (formerly known as "Nichols Aluminum LLC")	Management Company	USA	USA
Novelis ALR Rolled Products Sales Corporation (formerly known as "Aleris Rolled Products Sales Corporation")	Management Company	USA	USA
Novelis ALR Recycling of Ohio, LLC (formerly known as "IMCO Recycling of Ohio, LLC")	Manufacturing	USA	USA
Novelis ALR Aluminum-Alabama, LLC (formerly known as "Nichols Aluminum-Alabama LLC")	Dormant	USA	USA
Novelis ALR Asset Management Corporation (formerly known as "UWA Acquisition Co.")	Holding Company	USA	USA

During the year ended March 31, 2022:

- Saras Micro Device Inc., an entity incorporated in the state of Delaware and engaged in manufacturing activities, was formed on April 21, 2021. Subsequently, 90% stake in Saras Micro Devices, Inc. was sold on November 22, 2021.
- Aleris RM, Inc. and Name Acquisition Co. - Merged into Aleris International, Inc. on July 21, 2021
- Aleris Aluminum France SAS merged into Novelis PAE SAS on March 29, 2022
- Novelis Laminés France SAS merged into Novelis PAE SAS on March 29, 2022
- Aleris Aluminum Poland Sp. z.o.o. dissolved by operation of law into Aleris Switzerland GmbH on April 15, 2021
- 100% stake in Hindalco Do Brasil Industria Comercia de Alumina Ltda. was sold on March 7, 2022
- 100% equity stake in "Birla Copper Asoj Private Limited (formerly known as "Ryker Base Private Limited")" was acquired on November 18, 2021 through wholly owned subsidiary, Renuka Investments & Finance Limited.

## B. Non-Controlling Interests (NCI)

The Group has following non-wholly owned subsidiaries:

Name of Entity	Principal Activity	Country of Incorporation	Ownership interest held by the Group	
			31/03/2022	31/03/2021
Suvas Holdings Limited	Power Generation	India	74.00%	74.00%
Hindalco-Almex Aerospace Limited	Manufacturing	India	97.18%	97.18%
East Coast Bauxite Mining Company Private Limited	Mining	India	74.00%	74.00%

None of above non-wholly owned subsidiary is material to the Group, therefore financial information about these non-wholly owned subsidiary are not disclosed separately.

## C. Joint Operations

The Group is engaged in various arrangements on a joint basis with other companies. In assessing whether joint control exists for these arrangements, management evaluates the structure and legal framework and contracts governing the arrangement combined with an assessment of which decisions that significantly influence the return from the arrangement. The Group assesses whether joint arrangements are joint operations where the Group has rights to the assets and obligations for the liabilities related to the arrangement, or a joint venture where the group have an interest in the net assets of the joint arrangement. Accordingly, the Group has identified the following joint arrangements as joint operations:

Name of the joint operations	Principal Activity	Country of Incorporation	Group's proportion of ownership interest and voting power	
			31/03/2022	31/03/2021
Mahan Coal Limited - (a)	Mining	India	50.00%	50.00%
Tubed Coal Mines Limited - (a)	Mining	India	60.00%	60.00%
Aluminium Norf GmbH - (b)(i)	Rolling and recycling	Germany	50.00%	50.00%
Logan Aluminium Inc. - (b)(ii)	Rolling and finishing	USA	40.00%	40.00%
Ulsan Aluminium Limited - (b)(iii)	Rolling and recycling	South Korea	50.00%	50.00%
AluInfra Services SA - (b)(iv)	Service Company	Switzerland	50.00%	50.00%

- The proportionate share of total assets and total comprehensive income in the above joint operations are included in standalone financial statements of the Parent.
- Novelis Inc, a subsidiary of the Group, is engaged in the following arrangements that are concluded to be joint operations.
  - Aluminium Norf GmbH ("Alunorf"), a large rolling mill in Germany, is a joint operation between Novelis and Hydro Aluminium Deutschland GmbH ("Hydro"). Both Novelis and Hydro hold a 50% interest in equity, profits and losses, shareholder voting and management control. Novelis shares control of the management of Alunorf with Hydro through a jointly-controlled shareholders' committee and supervisory board. Management of Alunorf is led jointly by two managing executives, one nominated by Novelis and one nominated by Hydro. The primary objective of Alunorf is to provide tolling services (output) exclusively to Novelis and Hydro as the total output capacity is allocated between Novelis and Hydro. This indicates that both Novelis and Hydro get substantially all of the economic benefits from the assets of the joint arrangement. The major or sole sources of cash inflows for Alunorf are Novelis and Hydro, who are legally obliged to cover production costs.



# Notes

forming part of the Consolidated Financial Statements

- ii. Logan Aluminium Inc (“Logan”), an aluminum rolling mill in Kentucky, is a joint operation between Novelis and Tri-Arrows Aluminium Inc. (“Tri-Arrows”). Logan processes metal exclusively received from Novelis and Tri-Arrows and charges the respective partner a fee to cover expenses. This indicates that both Novelis and Tri-Arrows get substantially all of the economic benefits from the assets of the joint arrangement. Logan is thinly capitalized and relies on the regular reimbursement of costs and expenses by Novelis and Tri-Arrows to fund its operations, indicating that Novelis and Tri-Arrows have an obligation for the liabilities of the arrangement. Other than these contractually required reimbursements, Novelis does not provide other material support to Logan. Logan’s creditors do not have recourse to Novelis’ general credit. Novelis has a 40% voting interest; however, its participating interest in operations ranges from greater than 50% to approximately 55% depending on output. Novelis has joint ability to make decisions regarding Logan’s production operations and take its share of production and associated costs.
- iii. In May 2017, Novelis Korea Ltd., a subsidiary of Novelis Inc., entered into definitive agreements with Kobe Steel Ltd. (“Kobe”), an unrelated party, under which Novelis Korea and Kobe Steel Ltd. will jointly own and operate Ulsan Aluminum, Ltd. (UAL), the joint arrangement. UAL is controlled by an equally represented Board of Directors in which neither entity has sole decision making ability regarding production operations or other significant decisions. Furthermore, neither entity has the ability to take the majority share of production or associated costs over the life of the joint venture. UAL currently produces flat rolled aluminum products exclusively for Novelis and Kobe. Each of the parties to the joint arrangement hold a 50% interest in the equity, profits and losses, shareholder voting, management control and rights to use the production capacity of the facility.
- iv. In July 2018, Novelis Switzerland SA (Novelis Switzerland), a subsidiary of Novelis, entered into definitive agreements with Constellium Valais SA (Constellium), an unrelated party, under which Novelis Switzerland and Constellium will jointly own and operate AluInfra Services SA (AluInfra), the joint arrangement. Each of the parties to the joint arrangement hold a 50% interest in the equity, profits and losses, shareholder voting, management control and rights to use the production capacity of the facility.

## D. Investments in Associates:

Details of Associates of the Group are set out below. The country of incorporation is also their principal place of business and the proportion of ownership interest is the same as the proportion of voting rights held. The Group’s interests in these entities are accounted for using equity method in the Consolidated Financial statements.

Name of Entity	Country of Incorporation	Proportion of Ownership Interests (%)		Carrying Amount (₹ Crore)	
		31/03/2022	31/03/2021	31/03/2022	31/03/2021
		Aditya Birla Science & Technology Company Pvt. Limited (ABSTCPL)	India	49.00%	49.00%
Aditya Birla Renewable Subsidiary Limited (ABRSL)	India	26.00%	26.00%	6	8
Aditya Birla Renewable Utkal Limited (ABRUL)	India	26.00%	26.00%	2	1
Aditya Birla Renewable Solar Limited (ABRSolar) *	India	26.00%	26.00%	9	-
Deutsche Aluminum Verpackung Recycling GMBH #	Germany	30.00%	30.00%	-	-
France Aluminum Recyclage SPA. #	France	20.00%	20.00%	-	-
				<b>44</b>	<b>32</b>

\* Incorporated during the financial year 2021

# Immaterial associates with no existing operations.

- (a) Summarised financial information in respect of the Group’s associates are set out below. These information is based on their Ind-AS financial statements after alignment of Group’s accounting policies.

(₹ in Crore)

	As at							
	31/03/2022				31/03/2021			
	ABSTCPL	ABRSL	ABRUL	ABRSolar	ABSTCPL	ABRSL	ABRUL	ABRSolar
<b>Summarised Balance Sheet</b>								
Non-current Assets	110	111	20	156	100	119	21	4
Current Assets	43	7	1	5	52	8	1	-
Non-current Liabilities	(84)	(86)	(14)	(120)	(8)	(89)	(15)	-
Current Liabilities	(13)	(4)	(1)	(7)	(97)	(9)	(1)	(3)
<b>Net Assets</b>	<b>56</b>	<b>28</b>	<b>6</b>	<b>34</b>	<b>47</b>	<b>29</b>	<b>6</b>	<b>1</b>
Group’s share of Net Assets of Associates	27	7	2	9	23	8	1	-
Dividend Received	-	1	-	-	-	-	-	-
Carrying Amount	27	6	2	9	23	8	1	-
<b>Contingent Liabilities</b>								
Share of Contingent Liabilities of the associate	6	-	-	-	6	-	-	-

(₹ in Crore)

	Year ended							
	31/03/2022				31/03/2021			
	ABSTCL	ABRSL	ABRUL	ABRSolar	ABSTCL	ABRSL	ABRUL	ABRSolar
<b>Summarised Statement of Profit and Loss</b>								
Total Revenues	64	15	3	8	59	16	3	-
Total Profit/ (Loss) for the year	9	2	1	2	9	5	1	-
Other comprehensive income for the year	-	-	-	-	-	-	-	-
Group’s share of Profit/ (Loss) of Associates	4	1	-	1	4	1	-	-
Group’s share of Other comprehensive income of Associates	-	-	-	-	-	-	-	-
<b>Reconciliation to carrying amounts</b>								
Opening net assets	47	29	6	1	38	24	5	-
Increase on account of acquisition/issue	-	-	1	31	-	-	-	1
Profit/(Loss) for the year	9	2	1	2	9	5	1	-
Other comprehensive income	-	-	-	-	-	-	-	-
Amounts directly recognised in equity:								
Dividend Paid	-	(3)	(2)	-	-	-	-	-
<b>Closing net assets</b>	<b>56</b>	<b>28</b>	<b>6</b>	<b>34</b>	<b>47</b>	<b>29</b>	<b>6</b>	<b>1</b>
Group’s share (%)	49.00%	26.00%	26.00%	26.00%	49.00%	26.00%	26.00%	26.00%
Group’s share (Amount)	27	7	2	9	23	8	1	-
Dividend Received	-	(1)	-	-	-	-	-	-
<b>Carrying amount</b>	<b>27</b>	<b>6</b>	<b>2</b>	<b>9</b>	<b>23</b>	<b>8</b>	<b>1</b>	<b>-</b>

# Notes

forming part of the Consolidated Financial Statements

## E. Interests in Joint Ventures:

Details of Joint Ventures of the Group are set out below. The joint ventures listed below have share capital consisting solely equity shares, which are directly held by the Group. The country of incorporation is also their principal place of business and the proportion of ownership interest is the same as the proportion of voting rights held. No entity listed below is listed on any public stock exchange. The Group's interests in these entities are accounted for using equity method in the Consolidated Financial statements.

	Country of Incorporation	Proportion of Ownership Interests		Carrying Amount (₹ Crore)	
		31/03/2022	31/03/2021	31/03/2022	31/03/2021
MNH Shakti Limited (MNH Shakti)	India	15.00%	15.00%	7	14
Hydromine Global Minerals (GMBH) Limited (Hydromine)	British Virgin Islands	45.00%	45.00%	-	-
				<b>7</b>	<b>14</b>

## F. Interest in Trusts Consolidated as Subsidiaries :

The Group has following Trust which are consolidated in these financial statements.

Name of the Trust	Principal Activity	Country of Incorporation	Place of Operation
Hindalco Jan Seva Trust	Welfare	India	India
Copper Jan Seva Trust	Welfare	India	India
Utkal Alumina Jan Seva Trust	Welfare	India	India

## G. Interest in Trusts controlled by the Parent accounted as Treasury Shares:

Name of the Trust	% of Holding	Country of Incorporation	Place of Operation
Trident Trust	#	India	India
Hindalco Employee Welfare Trust	#	India	India

# Treasury Shares are held in Trusts whose sole beneficiary is Hindalco Industries Limited, refer note 16 for further details.

## 49. Business Combination

Refer Note 1B(B) for accounting policy on Business Combination

### A. Acquisition of Birla Copper Asoj Private Limited (formerly known as 'Ryker Base Private Limited'):

On November 18, 2021, the Group, through its wholly owned subsidiary Renuka Investments & Finance Limited, has completed its acquisition of 100% of the issued and outstanding shares of Ryker Base Private Limited which is in the business of manufacturing Copper Rods on job work basis, pursuant to a Share Purchase Agreement (the 'SPA'), dated as of November 3, 2021. The acquisition is in line with the Groups intention to expand in the downstream portfolio.

After completion of the acquisition, name of the acquired company changed to "Birla Copper Asoj Private Limited" ('Birla Asoj').

Details of purchase consideration, the net assets acquired and goodwill are as follows:

	(₹ in Crore)
<b>Purchase consideration</b>	<b>Amount</b>
Total amount paid	178
<b>Total Purchase Consideration</b>	<b>178</b>

The assets and liabilities recognized as a result of the acquisition as at November 18, 2021 are as follows:

Assets Acquired	Provisional amounts as at 18/11/2021	Measurement period adjustments*	As at 31/03/2022
Property, Plant and Equipment (incl. ROU assets)	241	43	284
Capital Work-in-Progress	3	-	3
Intangible Assets	1	6	7
Trade Receivables	72	-	72
Current Tax Assets	3	-	3
Inventories	9	-	9
Cash and Cash Equivalents	31	-	31
Other Current and Non-Current Assets	1	-	1
<b>Total Assets</b>	<b>361</b>	<b>49</b>	<b>410</b>
<b>Liabilities Assumed</b>			
Borrowings	139	-	139
Trade and Other Payables	112	-	112
Deferred Tax Liabilities (net)	8	12	20
Other Current and Non-Current Liabilities	24	-	24
<b>Total Liabilities</b>	<b>283</b>	<b>12</b>	<b>295</b>
<b>Net Identifiable Assets Acquired</b>	<b>78</b>	<b>37</b>	<b>115</b>

Calculation of goodwill	Provisional amounts as at 18/11/2021	Measurement period adjustments*	As at 31/03/2022
Purchase Consideration	178	-	178
Less: Net identifiable assets acquired	(78)	(37)	(115)
<b>Goodwill</b>	<b>100</b>	<b>(37)</b>	<b>63</b>

The Group has allocated the goodwill associated with the acquisition of Birla Asoj to the Copper segment.

\* Measurement period adjustment related to pending valuation of tangible and intangible assets and deferred tax impact thereon.

The above fair values of assets acquired and liabilities assumed are final as of March 31, 2022. The fair values of the assets acquired and liabilities assumed were determined using the income, cost and market approaches. In many cases, the determination of the fair values required estimates about discount rates, future expected cash flows and other future events that are judgmental and subject to change. The fair value measurements are primarily based on significant inputs that are not observable in the market and thus represent a Level 3 measurement of the fair value hierarchy as defined in Ind AS 113, Fair Value Measurements ("Ind AS 113"). Intangible assets consisting of Order Backlog is valued using the Multi Period Excess Earnings Method ("MPEEM") which is a form of the income approach. A cost and market approach has been applied, as appropriate, for Property and Equipment, including Land.

- Order Backlog intangible assets are valued using the MPEEM method. The significant assumptions used include the estimated annual net cash flows (including appropriate revenue and profit attributable to the asset, retention rate, applicable tax rate, and contributory asset charges, among other factors), the discount rate, reflecting the risks inherent in the future cash flow stream, an assessment of the asset's life cycle, and the tax amortization benefit, among other factors. Order Backlog is presented under "Favourable Contracts" in the Consolidated Financial Statements - (refer note 5).

# Notes

forming part of the Consolidated Financial Statements

- Property, Plant and Equipment, including Land, are valued using the cost and market approach, as appropriate. For assets valued using the cost approach, the cost to replace a given asset reflects the estimated reproduction or replacement cost for the property, less an allowance for loss in value due to depreciation. The market approach, which estimates value by leveraging comparable land sale data/listings and qualitatively comparing them to the in-scope properties, has been used to value the Land.

The amounts allocated to intangible assets and its useful life is as follows:

(₹ in Crore)		
	Gross carrying amount	Useful life
Favourable Contracts (Order backlog)	6	3 years
<b>Total</b>	<b>6</b>	

## Revenue and profit contribution

Since the acquisition date, the results of operations for Birla Asoj included in the Consolidated Financial Statements for the year ended March 31, 2022 comprises of Revenue of ₹ 87 crore and Net Loss of ₹ 4 crore.

## Purchase consideration - cash flow

(₹ in Crore)	
	Year ended
	31/03/2022
Outflow of cash required to acquire a subsidiary	178
Less: Cash and cash equivalents acquired	(31)
<b>Net outflow of cash - investing activities</b>	<b>147</b>

## B. Acquisition of Kuppam unit of SAPA Extrusions India Private Limited:

On February 1, 2022, Hindalco has completed the acquisition of the Extrusion business of SAPA Extrusion India Private Limited, manufacturer of high end extrusion products, pursuant to a Business Transfer Agreement dated December 17, 2021. The acquisition increases the Group's footprint in high end extrusion products by expanding the portfolio of services provided to its customers. During the year ended March 31, 2022, the Group has recognised acquisition related cost of ₹ 6 crore, which are included in Other Expenses in the Consolidated Statement of Profit and Loss and in operating cash flows in the Consolidated Statement of Cash Flows.

Details of purchase consideration, the net assets acquired and goodwill are as follows:

(₹ in Crore)	
	Amount
Total amount paid	265
<b>Total Purchase Consideration</b>	<b>265</b>

The Purchase Price Allocations were made to the assets acquired and liabilities assumed based on the estimated fair values at the date of acquisition. The excess of the purchase price over the fair value of the net assets acquired was allocated to goodwill, none of which is expected to be deductible for tax purposes. Goodwill is primarily attributed to synergies from future expected economic benefits, including enhanced revenue growth from expanded capabilities and geographic presence as well as cost savings from duplicative overhead, streamlined operations, and enhanced operational efficiency.

The assets and liabilities recognized as a result of the acquisition as at February 1, 2022 are as follows:

(₹ in Crore)	
	As at
	31/03/2022
<b>Assets acquired</b>	
Property, plant and equipment (including CWIP)	133
Intangible assets	23
Inventories	60
Trade Receivables	43
Other Assets	39
<b>Total assets</b>	<b>298</b>
<b>Liabilities assumed</b>	
Trade payables	29
Provisions	4
Other liabilities	4
<b>Total liabilities</b>	<b>37</b>
<b>Net identifiable assets acquired</b>	<b>261</b>

(₹ in Crore)	
	As at
	31/03/2022
<b>Calculation of goodwill</b>	
Consideration transferred	265
Less: Net identifiable assets acquired	(261)
<b>Goodwill</b>	<b>4</b>

The above fair values of assets acquired and liabilities assumed are final as of March 31, 2022. The fair values of the assets acquired and liabilities assumed were determined using the income and cost approach. In many cases, the determination of the fair values required estimates about discount rates, future expected cash flows and other future events that are judgmental and subject to change. The fair value measurements are primarily based on significant inputs that are not observable in the market and thus represent a Level 3 measurement of the fair value hierarchy as defined in Ind AS 113, Fair Value Measurements ("Ind AS 113"). Intangible assets consists of Customer Relationships valued using 'With and Without/incremental Cash flow method' and Technical Know How are valued using the 'Relief From Royalty method'. A cost and market approach has been applied, as appropriate, for Property, Plant and Equipment.

The Group has allocated the goodwill associated with the acquisition of Kuppam unit to the Aluminium segment.

## Revenue and profit contribution

Since the acquisition date, the results of operations for Kuppam included in the Consolidated Financial Statements for the year ended March 31, 2022 comprises of Revenue of ₹ 66 crore and Net Profit of ₹ 5 crore.

## Purchase consideration - cash flow

(₹ in Crore)	
	Year ended
	31/03/2022
Outflow of cash required to acquire Extrusion Business	265
<b>Net outflow of cash - investing activities</b>	<b>265</b>



# Notes

forming part of the Consolidated Financial Statements

- C. The following supplemental pro forma financial information presents the Group's results of operations as of March 31, 2022 as if the acquisitions of Birla Asoj and Kuppam had occurred at the beginning of the financial year of acquisition:

	(₹ in Crore)
	Year ended
	31/03/2022
Consolidated Revenue from Operations	195,839
Consolidated Profit After Tax for the year from Continuing and Discontinued Operations	13,766

## 50. Discontinued Operations

Refer Note 1B(H) for accounting policy on Non-Current assets (or Disposal Groups) Held for Sale

On April 14, 2020, the Group closed the acquisition of Aleris. As a result of the European Union (EU) and United States (US) antitrust review processes required for approval of the acquisition, the Group is obligated to divest Aleris' European and North American automotive assets, including its plants in Duffel, Belgium (Duffel) and Lewisport, Kentucky (Lewisport).

### Duffel

On September 30, 2020, the Group has completed the sale of its assets at Duffel, Belgium to ALVANCE, the international aluminum business of the GFG Alliance at a consideration of € 310 million as of September 30, 2020. Divestiture of Duffel was a precondition to the acquisition of Aleris as determined by the European Commission and Chinese State Administration for Market Regulation (SAMR). At the transaction date the Group has received € 210 million in cash. Both the parties have agreed to a post-closing arbitration process on the remaining € 100 million as of September 30, 2020. The arbitration does not relate to future events and relates solely to the period prior to consummation of the sale and the amount € 100 million as of September 30, 2020 has been recorded as contingent consideration, which is measured at fair value at each reporting date. Accordingly, the Group marked this contingent consideration to carrying value of € 96 million.

The Group has presented contingent consideration in "Other non current financial assets" and changes to the estimated fair value resulting from subsequent measurement will be recorded to "Loss from discontinued operations". During the year ended March 31, 2022, the Group marked all outstanding receivables related to the sale of Duffel to an estimated fair value of € 45 million (₹ 381 crore (\$ 51 million)), which resulted in a loss of € 51 million (₹ 454 crore (\$ 61 million)) recorded in "Loss from discontinued operations".

As of March 31, 2022, certain assets and liabilities of Duffel will remain within current assets of discontinued operations and current liabilities of discontinued operations in the consolidated balance sheets until ALVANCE is able to satisfy necessary regulatory requirements.

The results of operations of Duffel has been presented as discontinued operations in the Consolidated Statement of Profit and Loss for the year ended March 31, 2022.

### Lewisport

On November 8, 2020, the Group entered into a definitive agreement with American Industrial Partners (AIP) for the sale of Lewisport and the sale was completed on November 30, 2020 ("transaction date for Lewisport business"). Upon closing, the Group has received ₹ 1,335 crore (\$ 180 million) in cash proceeds. In addition, the Group has recorded a ₹ 123 crore (\$ 17 million) receivable for net working capital adjustments, which was received during current year.

The Group has incurred additional cost to sell amounting to ₹ 10 crore (\$ 1.3 million) primarily related to legal expenses recorded in "Loss from discontinued operations" for the year ended March 31, 2022.

The results of operations of Lewisport have been presented as discontinued operations in the Consolidated Statement of Profit and Loss for the year ended March 31, 2022.

- (a) The Financial Performance of the Discontinued Operations for the the year ended March 31, 2022 is as follows:

Particulars		(₹ in Crore)	
		Year ended	31/03/2021
		31/03/2022	31/03/2021
Total Income		-	7,948
Total Expenses		464	8,421
Impairment loss recognised as a result of remeasurement of fair value less cost to sell		-	1,661
<b>Loss before income tax</b>		<b>(464)</b>	<b>(2,134)</b>
Income tax benefit		(7)	354
<b>Loss after income tax from discontinued operations</b>	(a)	<b>(471)</b>	<b>(1,780)</b>
Gain on sale of Discontinued Operations (net)		-	68
Income tax benefit on sale of Discontinued Operations		-	13
<b>Gain after income tax on sale of discontinued operations</b>	(b)	<b>-</b>	<b>81</b>
<b>Loss from Discontinued Operations</b>	(a + b)	<b>(471)</b>	<b>(1,699)</b>
Foreign Currency Translation Reserve of Discontinued Operations		-	-
Remeasurement of Defined Benefit Obligation of Discontinued Operations (Net of tax ₹ 9 crore)		-	51
<b>Other Comprehensive Income/(Loss) for the year from discontinued operations</b>		<b>-</b>	<b>51</b>
<b>Total Comprehensive Income/(Loss) for the year from discontinued operations</b>		<b>(471)</b>	<b>(1,648)</b>

- (b) The following assets and liabilities were classified as held for sale in relation to the discontinued operation:

	(₹ in Crore)	
	As at	31/03/2021
	31/03/2022	31/03/2021
<b>Assets of disposal group classified as held for sale (refer Note 15A)</b>		
Inventory	-	73
Trade receivables	46	34
	<b>46</b>	<b>107</b>
<b>Liabilities of disposal group classified as held for sale (refer Note 15B)</b>		
Trade payables	93	114
Contract liabilities	-	5
	<b>93</b>	<b>119</b>

# Notes

forming part of the Consolidated Financial Statements

## 51. Disposal of Subsidiaries

### A. Disposal of Hindalco Do Brasil Industria e Comercio de Alumina Ltda.

In December 2021 the Group decided to sell its entire equity interest in its wholly owned Brazilian subsidiary, Hindalco Do Brasil Industria e Comercio de Alumina Ltda. ('Hindalco Do Brazil') and accordingly assets and liabilities of the same were classified as 'Disposal Group Held for Sale' and the Group recognized an impairment loss of ₹ 59 crore (USD 8 million) on the net assets of Hindalco Do Brazil in the Consolidated Financial Statements.

On March 7, 2022 the sale of Hindalco Do Brasil was completed and it ceased to be a subsidiary of the Group. As a result of this, the Group has recognised a loss on sale of subsidiary of ₹ 152 crore (USD 22 million), mainly on account of additional equity infusion of ₹ 164 crore (USD 22 million), which is presented as exceptional expenses in the Consolidated Financial Statements. (refer Note 37)

(₹ in Crore)	
Details of sale of Hindalco Do Brasil as on transaction date	As at
	March 7, 2022
Total Sale Consideration (USD 1)	-
Less: Net Assets sold (USD 22 million)	(164)
Add: Currency Translation adjustment	12
<b>Loss on sale of subsidiary</b>	<b>(152)</b>

### B. Disposal of Saras Micro Devices Inc.

On November 22, 2021, Novelis sold 90% of its equity ownership in Saras Micro Devices Inc., an early-stage business founded by Novelis on April 21, 2021, related to the development, design, manufacturing, and sale of aluminum-integrated passive devices for use in semiconductor and electronic systems. As a result of this, the Group has recognised a gain on sale of subsidiary of ₹ 112 crore (USD 15 million), which is presented as exceptional income in the Consolidated Financial Statements. (refer Note 37)

As part of this transaction, the Group received ₹ 66 crore (USD 9 million) in cash upon close and approximately ₹ 46 crore (USD 6 million) in deferred cash receipts, which comprise of promissory note due in November 2023 amounting to ₹ 23 crore (USD 3 million) and consideration receivable due in November 2022 amounting to ₹ 23 crore (USD 3 million).

## 52. Gare Palma IV/4 (GP-4), Gare Palma IV/5 (GP-5) and Kathautia coal mines were acquired by the Company through auction conducted by the Nominated Authority (NA constituted under the Ministry of Coal, Government of India. The Company was required to achieve certain efficiency parameters and reach their Peak Rated Capacity (PRC) during FY 2015-16. Performance security in the form of Performance Bank Guarantees (PBG) of ₹ 318 crore (for GP-4), ₹ 369 crore (for GP-5) and ₹ 267 crore (for Kathautia) were provided by the Company to NA in this regard.

Due to the various delays on the part of Government Authorities, PRC was achieved by the Company for GP-4 and GP-5 during FY 2016-17 and for Kathautia during FY 2017-18. Having satisfied itself about achievement of efficiency parameters/ PRC, NA returned the PBG in respect of GP-4 on June 19, 2017. However, in a volte face action, vide a letter dated 25th April, 2018, NA imposed a penalty equal to 20% of PBG amounting to ₹ 64 crore for GP-4, ₹ 74 crore for GP-5 and ₹ 118 crore for Kathautia (refer note 10). As the PBG for GP-5 and Kathautia was still with NA, it also appropriated an amount equal to the penalty from the PBG of the respective mines.

The above actions were contested by the Company. The Hon'ble Chhattisgarh High Court at Bilaspur has already given its judgment in favour of the Company in the matter related to GP-5. As per the judgment, Hon'ble High Court has asked NA to refund the amount appropriated by them and return the PBG to the Company. The NA has filed an appeal before the Hon'ble Supreme Court which has not been taken up for hearing yet. The Company's appeal to quash the demand raised by NA in case of GP-4 and Kathautia is yet to be decided and is pending before the Mines Tribunal at Bilaspur and Ranchi respectively.

## 53. Additional regulatory information required by Schedule III to be disclosed in the consolidated financial statements:

### A. Relationship with struck off companies

Disclosure related to relationship of the Company with a company which is Struck off under Section 248 of the Companies Act, 2013 or Section 530 of Companies Act, 1956:

Name of struck off Company	Nature of transactions with struck-off Company	Balance outstanding as at 31/03/2022	Balance outstanding as at 31/03/2021	Relationship with Relationship with the Struck off company, if any, to be disclosed
<b>Receivables</b>				
1. Daga Nylomet Private Limited	Sale of Goods and Services	1	1	Not a related party
2. Gapsbib Trading Private Limited	Sale of Goods and Services	2	2	Not a related party
<b>Payables</b>				
1. KNOP Trading Company Pvt. Ltd.	Purchase Goods and Services	-	-	Not a related party
2. Saturn Mining & Exploration Pvt. Ltd.	Purchase Goods and Services	-	-	Not a related party
3. Agngreen Pest Control Services Pvt. Ltd.	Purchase Goods and Services	-	-	Not a related party
4. Black Bird E-Solutions Pvt. Ltd.	Purchase Goods and Services	-	-	Not a related party
5. Singhal Bricks Pvt. Ltd.	Purchase Goods and Services	-	-	Not a related party
6. Sonebhadra Automobiles Pvt. Ltd.	Purchase Goods and Services	-	-	Not a related party
<b>Other Outstanding balances</b>				
1. Apple Insulated Wires Pvt. Ltd.	Contract liability	-	-	Not a related party
2. Payal Synthetics Pvt. Ltd.	Contract liability	-	-	Not a related party
3. Tecon Surface Coating & Engineering Pvt. Ltd.	Contract liability	-	-	Not a related party

### B. Details of loans given, investment made and guarantee given covered under section 186(4) of the Companies Act, 2013:

(i) Loans and Financial Guarantees given below:

(₹ in Crore)				
Name of the Company	Relationship	Nature of Transaction	As at	
			31/03/2022	31/03/2021
Aditya Birla Science and Technology Company Private Limited	Associate	Loan	36	41

# Notes

forming part of the Consolidated Financial Statements

- (ii) Disclosure relating to amount outstanding at year end and maximum outstanding during the year of loans and advances, in nature of loan, required under SEBI (Listing Obligations and Disclosure Requirements) Regulations, 2015, are given below:

Name of the Company	Relationship	Outstanding balance as at				Maximum outstanding during the year ended on	
		31/03/2022		31/03/2021		31/03/2022	
		31/03/2022	31/03/2021	31/03/2022	31/03/2021	31/03/2022	31/03/2021
Aditya Birla Science and Technology Company Private Limited	Associate	36	41	41	46		

## C. Other disclosures required under Schedule III amendments

- No proceedings have been initiated on or are pending against the Group for holding benami property under the Benami Transactions (Prohibition) Act, 1988 (45 of 1988) and Rules made thereunder.
- None of the entities in the Group have been declared wilful defaulter by any bank or financial institution or government or any government authority.
- The Group has complied with the number of layers prescribed under the Companies Act, 2013.
- There is no undisclosed income under the tax assessments under the Income Tax Act, 1961 for the year ending March 31, 2022 and March 31, 2021 which needs to be recorded in the books of account of any of the entities consolidated in the Group.
- The Group has not traded or invested in crypto currency or virtual currency during the current or previous year.
- Utilisation of borrowed funds and share premium
  - The Group has not advanced or loaned or invested funds to any other person(s) or entity(ies), including foreign entities (Intermediaries) with the understanding that the Intermediary shall:
    - directly or indirectly lend or invest in other persons or entities identified in any manner whatsoever by or on behalf of the group (Ultimate Beneficiaries) or
    - provide any guarantee, security or the like to or on behalf of the ultimate beneficiaries
  - The Group has not received any fund from any person(s) or entity(ies), including foreign entities (Funding Party) with the understanding (whether recorded in writing or otherwise) that the Group shall:
    - directly or indirectly lend or invest in other persons or entities identified in any manner whatsoever by or on behalf of the Funding Party (Ultimate Beneficiaries) or
    - provide any guarantee, security or the like on behalf of the ultimate beneficiaries
- Borrowings obtained by the Group from banks and financial institutions have been applied for the purposes for which such loans were taken.

## 54. Subsequent Events

In April 2022, Novelis amended its ABL Revolver facility to increase the limit on committed letters of credit under the facility to ₹ 2,087 crore (USD 275 million).

55. During the financial year ended March 31, 2022, the Group has reclassified following comparatives which are primarily to conform to the current years classification. This reclassifications do not have material impact on the Consolidated Financial Statements.

Note No.	Note Description	Previously Reported Amount	Revised Amount	Change
<b>A. Consolidated Balance Sheet</b>				
<b>Assets</b>				
8B	Other Financial Assets, Current	1,089	1,211	122
10	Other Current Assets	2,785	2,673	(112)
9B	Deferred Tax Assets (Net)	887	924	37
<b>Liabilities</b>				
21B	Other Financial Liabilities, Current	3,495	2,531	(964)
18B	Borrowings, Current	6,029	6,993	964
20	Trade Payables	28,222	28,177	(45)
9B	Deferred Tax Liabilities (Net)	4,493	4,530	(37)
9C	Current Tax Liabilities (Net)	2,116	2,126	(10)
23	Other Current Liabilities	1,341	1,386	45
				-
<b>B. Consolidated Statement of Profit and Loss</b>				
<b>Income</b>				
25	Revenue from Operations	131,985	132,008	23
26	Other Income	1,222	1,199	(23)
<b>Expenses</b>				
27	Cost of Materials Consumed	77,630	77,484	(146)
31	Power and Fuel	8,646	8,667	21
36	Other Expenses	18,327	18,452	125
				-



# Notes

forming part of the Consolidated Financial Statements

## 56. Additional information required under Schedule III of the Companies Act, 2013

### A. Information regarding subsidiaries, associates and joint ventures included in the consolidated financial statements for the year ended March 31, 2022:

(₹ in Crore)

	Net Assets i.e. total Assets minus total Liabilities		Share in Profit/ (Loss)		Share in Other Comprehensive Income		Share in Total Comprehensive Income	
	As % of Consolidated Net Assets	Amount	As % of Consolidated Profit/ (Loss)	Amount	As % of Other Comprehensive Income	Amount	As % of Total Comprehensive Income	Amount
<b>Parent:</b>								
Hindalco Industries Limited	69.60%	54,428	40.11%	5,507	34.58%	(397)	40.61%	5,110
<b>Subsidiaries:</b>								
<b>Indian:</b>								
Minerals & Minerals Limited	0.02%	14	0.02%	3	0.00%	-	0.02%	3
Utkal Alumina International Limited	11.64%	9,099	8.00%	1,099	-0.78%	9	8.81%	1,108
Utkal Alumina Social Welfare Foundation	0.00%	-	0.00%	-	0.00%	-	0.00%	-
Suvas Holdings Limited	0.04%	30	0.00%	-	0.00%	-	0.00%	-
Renuka Investments & Finance Limited	0.30%	235	0.01%	1	-4.62%	53	0.43%	54
Renukeshwar Investments & Finance Limited	0.18%	137	-0.01%	(1)	-5.05%	58	0.45%	57
Dahej Harbour and Infrastructure Limited	0.12%	95	0.09%	13	0.00%	-	0.10%	13
Lucknow Finance Company Limited	0.02%	19	0.01%	2	0.00%	-	0.02%	2
Hindalco-Almex Aerospace Limited	0.14%	106	0.06%	8	0.00%	-	0.06%	8
East Coast Bauxite Mining Company Private Ltd	0.00%	-	0.00%	-	0.00%	-	0.00%	-
Kosala Livelihood and Social Foundation	0.00%	1	0.00%	-	0.00%	-	0.00%	-
Birla Copper Asoj Private Limited	0.10%	75	-0.03%	(4)	0.00%	-	-0.03%	(4)
<b>Foreign:</b>								
AV Minerals (Netherlands) N.V.	14.27%	11,157	-1.82%	(250)	-32.32%	371	0.96%	121
AV Metals Inc.	14.21%	11,110	0.00%	-	-35.80%	411	3.27%	411
Novelis Inc. (Consolidated)	39.30%	30,734	54.84%	7,529	78.66%	(903)	52.66%	6,626
Hindalco Do Brasil Industria Comercia de Alumina Ltda.	0.00%	-	-0.12%	(16)	-3.22%	37	0.17%	21
Non-controlling Interest	0.01%	11	0.00%	-	0.00%	-	0.00%	-

(₹ in Crore)

	Net Assets i.e. total Assets minus total Liabilities		Share in Profit/ (Loss)		Share in Other Comprehensive Income		Share in Total Comprehensive Income	
	As % of Consolidated Net Assets	Amount	As % of Consolidated Profit/ (Loss)	Amount	As % of Other Comprehensive Income	Amount	As % of Total Comprehensive Income	Amount
<b>Associates</b>								
<b>Indian:</b>								
Aditya Birla Renewable Subsidiary Limited	0.01%	7	0.00%	-	0.00%	-	0.00%	-
Aditya Birla Renewable Utkal Limited	0.00%	1	0.00%	-	0.00%	-	0.00%	-
Aditya Birla Renewable Solar Limited	0.01%	9	0.01%	1	0.00%	-	0.01%	1
Aditya Birla Science and Technology Co. Pvt. Ltd.	0.03%	27	0.03%	4	0.00%	-	0.03%	4
<b>Joint Ventures</b>								
<b>Indian:</b>								
MNH Shakti Limited	0.01%	6	0.01%	1	0.00%	-	0.01%	1
<b>Foreign:</b>								
Hydromine Global Minerals (GBH) Limited	0.00%	-	0.00%	-	0.00%	-	0.00%	-
<b>Trusts (Consolidated as Subsidiaries)</b>								
<b>Indian:</b>								
Hindalco Jana Seva Trust	0.00%	2	0.00%	-	0.00%	-	0.00%	-
Copper Jann Seva Trust	-0.01%	(6)	-0.03%	(4)	0.00%	-	-0.03%	(4)
Utkal Alumina Jana Seva Trust	0.00%	1	0.00%	-	0.00%	-	0.00%	-
	<b>149.99%</b>	<b>117,298</b>	<b>101.19%</b>	<b>13,893</b>	<b>31.45%</b>	<b>(361)</b>	<b>107.55%</b>	<b>13,532</b>
Consolidation Adjustments	-49.99%	(39,096)	-1.19%	(163)	68.55%	(787)	-7.55%	(950)
	<b>100.00%</b>	<b>78,202</b>	<b>100.00%</b>	<b>13,730</b>	<b>100.00%</b>	<b>(1,148)</b>	<b>100.00%</b>	<b>12,582</b>

### B. Information regarding subsidiaries, associates and joint ventures included in the consolidated financial statements for the year ended March 31, 2021:

(₹ in Crore)

	Net Assets i.e. total Assets minus total Liabilities		Share in Profit/ (Loss)		Share in Other Comprehensive Income		Share in Total Comprehensive Income	
	As % of Consolidated Net Assets	Amount	As % of Consolidated Profit/ (Loss)	Amount	As % of Other Comprehensive Income	Amount	As % of Total Comprehensive Income	Amount
<b>Parent:</b>								
Hindalco Industries Limited	75.24%	50,064	28.51%	993	79.01%	3,780	57.74%	4,773
<b>Subsidiaries:</b>								
<b>Indian:</b>								
Minerals & Minerals Limited	0.02%	11	0.00%	-	0.00%	-	0.00%	-

# Notes

forming part of the Consolidated Financial Statements

(₹ in Crore)

	Net Assets i.e. total Assets minus total Liabilities		Share in Profit/ (Loss)		Share in Other Comprehensive Income		Share in Total Comprehensive Income	
	As % of Consolidated Net Assets	Amount	As % of Consolidated Profit/ (Loss)	Amount	As % of Other Comprehensive Income	Amount	As % of Total Comprehensive Income	Amount
Utkal Alumina International Limited	12.01%	7,991	17.40%	606	-0.02%	(1)	7.32%	605
Utkal Alumina Social Welfare Foundation	0	-	0.00%	-	0.00%	-	0.00%	-
Suvas Holdings Limited	0.04%	29	0.00%	-	0.00%	-	0.00%	-
Renuka Investments & Finance Limited	0.23%	156	0.11%	4	1.30%	62	0.80%	66
Renukeshwar Investments & Finance Limited	0.12%	80	0.09%	3	0.61%	29	0.39%	32
Dahej Harbour and Infrastructure Limited	0.12%	82	-0.20%	(7)	0.00%	-	-0.08%	(7)
Lucknow Finance Company Limited	0.03%	18	0.06%	2	0.00%	-	0.02%	2
Hindalco-Almex Aerospace Limited	0.15%	97	0.14%	5	0.00%	-	0.06%	5
East Coast Bauxite Mining Company Private Ltd	0.00%	-	0.00%	-	0.00%	-	0.00%	-
Kosala Livelihood and Social Foundation	0.00%	-	0.00%	-	0.00%	-	0.00%	-
<b>Foreign:</b>								
AV Minerals (Netherlands) N.V.	17.50%	11,648	0.03%	1	-7.30%	(349)	-4.21%	(348)
AV Metals Inc.	17.19%	11,438	0.00%	-	-7.17%	(343)	-4.15%	(343)
Novelis Inc. (Consolidated)	37.51%	24,958	55.61%	1,937	21.36%	1,022	35.79%	2,959
Hindalco Do Brasil Industria Comercia de Alumina Ltda.	0.10%	66	-0.29%	(10)	0.46%	22	0.15%	12
Non-controlling Interest	0.02%	10	0.00%	-	0.00%	-	0.00%	-
<b>Associates</b>								
<b>Indian:</b>								
Aditya Birla Renewable Subsidiary Limited	0.01%	8	0.03%	1	0.00%	-	0.01%	1
Aditya Birla Renewable Utkal Limited	0.00%	1	0.00%	-	0.00%	-	0.00%	-
Aditya Birla Renewable Solar Limited	0.00%	-	0.00%	-	0.00%	-	0.00%	-
Aditya Birla Science and Technology Co. Pvt. Ltd.	0.03%	23	0.11%	4	0.00%	-	0.05%	4

(₹ in Crore)

	Net Assets i.e. total Assets minus total Liabilities		Share in Profit/ (Loss)		Share in Other Comprehensive Income		Share in Total Comprehensive Income	
	As % of Consolidated Net Assets	Amount	As % of Consolidated Profit/ (Loss)	Amount	As % of Other Comprehensive Income	Amount	As % of Total Comprehensive Income	Amount
<b>Joint Ventures</b>								
<b>Indian:</b>								
MNH Shakti Limited	0.02%	14	0.03%	1	0.00%	-	0.01%	1
<b>Foreign:</b>								
Hydromine Global Minerals (GMBH) Limited	0.00%	-	-0.03%	(1)	0.00%	-	-0.01%	(1)
<b>Trusts (Consolidated as Subsidiaries)</b>								
<b>Indian:</b>								
Hindalco Jana Seva Trust	0.00%	2	0.00%	-	0.00%	-	0.00%	-
Copper Jann Seva Trust	0.00%	(3)	-0.14%	(5)	0.00%	-	-0.06%	(5)
Utkal Alumina Jana Seva Trust	0.00%	(1)	-0.03%	(1)	0.00%	-	-0.01%	(1)
	<b>160.34%</b>	<b>106,692</b>	<b>101.44%</b>	<b>3,533</b>	<b>88.25%</b>	<b>4,222</b>	<b>93.81%</b>	<b>7,755</b>
Consolidation Adjustments	-60.34%	(40,149)	-1.44%	(50)	11.75%	562	6.19%	512
	<b>100.00%</b>	<b>66,543</b>	<b>100.00%</b>	<b>3,483</b>	<b>100.00%</b>	<b>4,784</b>	<b>100.00%</b>	<b>8,267</b>

As per our report annexed  
**For Price Waterhouse & Co Chartered Accountants LLP**  
 Firm Registration No. 304026E/E-300009

**Sarah George**  
 Partner  
 Membership No. 045255

Place: Mumbai  
 Date: May 26, 2022

For and on behalf of the Board of **Hindalco Industries Limited**

**Praveen Kumar Maheshwari**  
 Whole-time Director and  
 Chief Financial Officer  
 DIN-00174361

**Anil Malik**  
 Company Secretary

**Satish Pai**  
 Managing Director  
 DIN-06646758

**K N Bhandari**  
 Director  
 DIN-00026078

# Annexure VII

## FINANCIAL INFORMATION RELATING TO SUBSIDIARY COMPANIES FOR THE YEAR ENDED 31ST MARCH 2022 Sec.129(3)

Sr.	Name of the Subsidiary Company	Country	Reporting currency	Capital	Reserves	Total Assets	Total Liabilities	Investments Shares, Debiture, Bonds & Others	Turnover/ Revenues	Profit/(Loss) before Tax	Provision for Tax	Gain/Loss from Discontinued Operations	Profit/(Loss) after Tax	Proposed Dividend	% of Share Holding
1	Minerals and Minerals Limited	India	INR	0.05	13.60	32.45	18.80	-	46.36	4.21	1.38	-	2.84	-	100
2	Renuka Investment and Finance Limited	India	INR	34.25	200.72	238.64	3.67	233.42	3.65	3.08	2.43	-	0.65	-	100
3	Renukeshwar Investment and Finance Limited	India	INR	4.80	132.37	137.93	0.76	137.87	3.61	3.60	4.44	-	(0.84)	-	100
4	Suvas Holding Limited	India	INR	29.93	(2.83)	35.98	6.33	0.05	3.51	0.22	0.05	-	0.17	-	74
5	Utkal Alumina International Limited	India	INR	6,251.48	2,847.99	13,050.72	3,951.25	651.94	4,741.65	1,701.34	602.18	-	1,099.16	-	100
6	Hindalco-Almex Aerospace Limited	India	INR	88.56	17.71	112.49	6.22	41.93	126.65	8.32	0.47	-	7.85	-	97
7	Lucknow Finance Company Limited	India	INR	9.90	9.51	20.56	1.14	11.63	2.65	2.24	0.34	-	1.90	-	100
8	Dahej Harbour and Infrastructure Limited	India	INR	50.00	45.01	133.06	38.05	90.04	57.58	20.97	7.72	-	13.25	-	100
9	East Coast Bauxite Mining Co.Pvt.Ltd.	India	INR	0.01	(0.05)	0.01	0.04	-	-	(0.00)	-	-	(0.00)	-	74
10	Utkal Alumina Social Welfare Foundation	India	INR	0.10	0.01	0.24	0.12	-	-	0.03	-	-	0.03	-	100
11	Kosala Livelihood and Social Foundation	India	INR	1.6	(0.39)	1.38	0.17	-	0.41	(0.39)	-	-	(0.39)	-	100
12	Birla Copper ASOJ Private Limited (Erstwhile Ryker Base Pvt Ltd)	India	INR	52.02	22.74	276.68	201.92	-	87.38	(5.99)	(1.53)	-	(4.46)	-	100
13	A V Minerals ( Netherlands) N.V. *	Netherlands	INR	12,590.63	(1,433.80)	11,156.83	-	-	-	(250.04)	-	-	(250.04)	-	100
14	A V Metals Inc. #*	Canada	USD	1,658.74	(188.89)	1,469.84	-	-	-	(33.57)	-	-	(33.57)	-	100
15	Novelis Inc.*	Canada	INR	11,234.67	1,286.26	23,375.15	10,854.23	-	5,082.27	4,601.12	(380.74)	(38.33)	4,943.54	-	100
16	4260848 Canada Inc.*	Canada	USD	1,480.00	169.44	3,079.32	1,429.88	-	682.24	617.65	(51.11)	(5.14)	663.62	-	100
17	4260856 Canada Inc.*	Canada	USD	930.98	(630.78)	305.50	5.29	-	209.63	11.52	-	-	198.11	-	100
18	Novelis South America Holdings LLC*	USA	USD	122.64	(83.10)	40.24	0.70	-	28.14	1.55	-	-	26.59	-	100
19	Novelis Corporation*	USA	INR	1,396.52	(957.46)	446.95	7.90	-	312.76	17.19	-	-	295.57	-	100
20	Novelis de Mexico SA de CV*	Mexico	USD	183.97	(126.13)	58.88	1.04	-	41.98	2.31	-	-	39.68	-	100
21	Novelis do Brasil Ltda.*	Brazil	USD	0.01	(0.01)	-	-	-	-	-	-	-	-	-	100
22	Novelis Korea Limited*	South Korea	INR	0.30	(5,017.95)	43,534.39	48,552.04	-	45,940.47	238.38	(14.90)	-	253.28	-	100
23	Novelis UK Ltd*	United Kingdom	USD	0.04	(661.04)	5,735.00	6,396.00	-	6,167.00	32.00	(2.00)	-	34.00	-	100
24	Novelis Services Limited*	United Kingdom	INR	0.05	(0.05)	-	-	-	-	-	-	-	-	-	100
25	Novelis Deutschland GmbH*	Germany	EUR	0.01	(0.01)	-	-	-	-	-	-	-	-	-	100
26	Novelis Aluminium Beteiligungs GmbH*	Germany	EUR	0.03	0.02	0.05	-	-	-	-	-	-	-	-	100
27	Novelis Switzerland SA*	Switzerland	INR	4114	3,647.96	5,677.95	1,988.86	-	6,728.53	22.66	0.21	-	22.46	-	100
28	Novelis Italia SPA*	Italy	CHF	5.00	443.41	690.16	241.75	-	829.77	2.80	0.03	-	2.77	-	100
29	Novelis Aluminium Holding Unlimited Company*	Ireland	INR	452.71	200.63	1,574.62	921.28	-	2,728.83	96.42	7.40	-	89.02	-	100
30	Novelis PAE SAS*	France	EUR	53.86	23.87	187.32	109.60	-	315.22	11.14	0.86	-	10.28	-	100
31	Novelis Europe Holdings Limited*	United Kingdom	INR	1,824.91	(33.55)	8,808.09	7,016.73	-	(1,173.75)	(441.89)	-	-	(731.86)	-	100
			EUR	217.10	(3.99)	1,047.83	834.73	-	(135.59)	(51.05)	-	-	(84.54)	-	100
			INR	33.96	151.61	324.96	139.40	-	101.26	2.00	(0.15)	-	2.15	-	100
			EUR	4.04	18.04	38.66	16.58	-	11.70	0.23	(0.02)	-	0.25	-	100
			INR	372.70	1,599.39	5,732.09	3,760.00	-	(153.09)	-	-	-	(153.09)	-	100
			USD	49.10	210.70	755.12	495.32	-	(20.55)	-	-	-	(20.55)	-	100

Sr.	Name of the Subsidiary Company	Country	Reporting currency	Capital	Reserves	Total Assets	Total Liabilities	Investments Shares, Debiture, Bonds & Others	Turnover/ Revenues	Profit/(Loss) before Tax	Provision for Tax	Gain/Loss from Discontinued Operations	Profit/(Loss) after Tax	Proposed Dividend	% of Share Holding
19	Novelis Corporation*	USA	INR	0.30	(5,017.95)	43,534.39	48,552.04	-	45,940.47	238.38	(14.90)	-	253.28	-	100
20	Novelis de Mexico SA de CV*	Mexico	USD	0.04	(661.04)	5,735.00	6,396.00	-	6,167.00	32.00	(2.00)	-	34.00	-	100
21	Novelis do Brasil Ltda.*	Brazil	INR	0.05	(0.05)	-	-	-	-	-	-	-	-	-	100
22	Novelis Korea Limited*	South Korea	INR	1,530.77	4,460.18	15,573.88	9,582.94	-	19,528.52	3,543.18	905.14	-	2,638.03	-	100
23	Novelis UK Ltd*	United Kingdom	BRL	958.53	2,792.85	9,751.96	6,000.59	-	13,967.20	2,534.15	647.38	-	1,886.78	-	100
24	Novelis Services Limited*	United Kingdom	INR	1,457.60	1,279.67	4,157.63	1,420.36	-	4,742.62	302.95	47.57	-	255.38	-	100
25	Novelis Deutschland GmbH*	Germany	GBP	146.10	128.26	416.72	142.36	-	466.04	29.77	4.68	-	25.10	-	100
26	Novelis Aluminium Beteiligungs GmbH*	Germany	INR	1,525.87	2,817.79	4,344.74	1,08	-	332.15	373.13	31.33	-	341.79	-	100
27	Novelis Switzerland SA*	Switzerland	USD	201.01	371.20	572.35	0.14	-	44.59	50.09	4.21	-	45.88	-	100
28	Novelis Italia SPA*	Italy	INR	2,864.73	37.58	13,488.72	10,586.40	-	29,831.71	(979.78)	0.02	-	(979.79)	-	100
29	Novelis Aluminium Holding Unlimited Company*	Ireland	EUR	340.80	4.47	1,604.65	1,259.39	-	3,446.03	(113.18)	0.00	-	(113.18)	-	100
30	Novelis PAE SAS*	France	INR	0.21	0.18	0.39	-	-	-	-	-	-	-	-	100
31	Novelis Europe Holdings Limited*	United Kingdom	EUR	0.03	0.02	0.05	-	-	-	-	-	-	-	-	100
			INR	4114	3,647.96	5,677.95	1,988.86	-	6,728.53	22.66	0.21	-	22.46	-	100
			CHF	5.00	443.41	690.16	241.75	-	829.77	2.80	0.03	-	2.77	-	100
			INR	452.71	200.63	1,574.62	921.28	-	2,728.83	96.42	7.40	-	89.02	-	100
			EUR	53.86	23.87	187.32	109.60	-	315.22	11.14	0.86	-	10.28	-	100
			INR	1,824.91	(33.55)	8,808.09	7,016.73	-	(1,173.75)	(441.89)	-	-	(731.86)	-	100
			EUR	217.10	(3.99)	1,047.83	834.73	-	(135.59)	(51.05)	-	-	(84.54)	-	100
			INR	33.96	151.61	324.96	139.40	-	101.26	2.00	(0.15)	-	2.15	-	100
			EUR	4.04	18.04	38.66	16.58	-	11.70	0.23	(0.02)	-	0.25	-	100
			INR	372.70	1,599.39	5,732.09	3,760.00	-	(153.09)	-	-	-	(153.09)	-	100
			USD	49.10	210.70	755.12	495.32	-	(20.55)	-	-	-	(20.55)	-	100





Figures INR in Crore & FC in Million

Sr.	Name of the Subsidiary Company	Country	Reporting currency	Capital	Reserves	Total Assets	Total Liabilities	Investments Shares, Debiture, Bonds & Others	Turnover/ Revenues	Profit/(Loss) before Tax	Provision for Tax	Gain/Loss from Discontinued Operations	Profit/(Loss) after Tax	Proposed Dividend	% of Share Holding
58	Novelis Netherlands B.V.*	Netherlands	INR	6,437.46	(2,708.19)	4,207.42	478.14	-	-	24.66	5.57	(0.66)	18.43	-	100
			EUR	765.82	(322.17)	500.53	56.88	-	-	2.85	0.64	(0.08)	2.13	-	
59	Aleris Switzerland GmbH*	Switzerland	INR	0.16	29.36	122.08	92.55	-	-	(4.52)	-	-	(4.52)	-	100
			CHF	0.02	3.57	14.84	11.25	-	-	(0.56)	-	-	(0.56)	-	
60	Aleris Aluminium UK Limited*	United Kingdom	INR	0.00	0.34	0.72	0.37	-	0.35	(0.27)	-	-	(0.27)	-	100
			GBP	0.00	0.03	0.07	0.04	-	0.03	(0.03)	-	-	(0.03)	-	
61	Aleris Aluminium Japan, Ltd.*	Japan	INR	0.74	1.02	2.13	0.37	-	1.97	0.12	0.08	-	0.04	-	100
			JPY	12.00	16.41	34.41	6.00	-	29.74	1.88	1.24	-	0.64	-	
62	Aleris Asia Pacific International (Barbados) Ltd.*	Barbados	INR	42.28	(21.19)	21.72	0.64	-	-	(0.09)	-	-	(0.09)	-	100
			EUR	5.03	(2.52)	2.58	0.08	-	-	(0.01)	-	-	(0.01)	-	
63	Aleris (Shanghai) Trading Co., Ltd.*	China	INR	52.36	(13.72)	154.59	115.95	-	350.23	3.06	0.88	-	2.18	-	100
			CNY	43.74	(11.46)	129.15	96.87	-	301.72	2.63	0.75	-	1.88	-	
64	Aleris Asia Pacific Limited*	Hong Kong	INR	4,226.43	(1,843.29)	2,397.11	13.97	-	17.99	(30.22)	1.31	-	(31.52)	-	100
			USD	556.77	(242.83)	315.78	1.84	-	2.42	(4.06)	0.18	-	(4.23)	-	
65	Novelis Aluminum (Zhenjiang) Co., Ltd.*	China	INR	3,853.60	(1,901.16)	3,609.52	1,657.09	-	961.70	(29.52)	-	-	(29.52)	-	100
			CNY	3,219.38	(1,588.27)	3,015.47	1,384.37	-	828.49	(25.43)	-	-	(25.43)	-	
66	Hindalco Do Brazil Industria Comercio de Alumina LTDS*	Brazil	INR	-	-	-	-	-	2,807.45	(160.68)	-	-	(161.95)	-	-
			Reals	-	-	-	-	-	200.45	(11.58)	-	-	(11.58)	-	

# Subsidiary of AV Minerals (Netherlands) N.V.

## Subsidiary of AV Metals Inc.

\* Balance sheet items are translated at closing exchange rate and Profit/(Loss) items are translated at average exchange rate.

#### List of Subsidiaries merged during FY 21-22

Aleris Aluminum France S.à.r.l. Merged into Novelis PAE S.A.S.

Novelis Lamines France S.A.S. Merged into Novelis PAE S.A.S.

Aleris RM, Inc. Merged into Novelis ALR International, Inc. (formerly Aleris International, Inc.)

Name Acquisition Co. Merged into Novelis ALR International, Inc. (formerly Aleris International, Inc.)

#### List of Subsidiaries Dissolved during FY 21-22

Aleris Aluminum Denmark ApS Dissolved into Aleris Switzerland GmbH

Aleris Aluminum Poland Sp. z.o.o. Dissolved into Aleris Switzerland GmbH

#### List of Subsidiaries sold during FY 21-22

Saras Micro Devices, Inc. (Novelis sold 90% ownership of entity. Legal entity still exists but investment is not held as a venture/associate. )

From Ccy	To Ccy	Avg spot rate for the year	Closing rate for 31st March 2022
AUD	INR	55.0692	56.8946
BRL	INR	13.9816	15.9659
CAD	INR	59.4266	60.8311
CHF	INR	81.0894	82.2729
CNY	INR	11.6078	11.9724
EUR	INR	86.5690	84.0610
GBP	INR	101.7635	99.7657
JPY	INR	0.6634	0.6243
NOK	INR	8.5851	8.6410
SEK	INR	8.4616	8.0905
SGD	INR	55.2329	56.0329
USD	INR	74.4927	75.9050

From Ccy	To Ccy	Avg spot rate for the year	Closing rate for 31st March 2022
BRL	USD	0.1877	0.2103
CHF	USD	1.0886	1.0839
CNY	USD	0.1558	0.1577
EUR	USD	1.1624	1.1075
GBP	USD	1.3664	1.3144
JPY	USD	0.0089	0.0082
SEK	USD	0.1136	0.1066
SGD	USD	0.7415	0.7382

## Annexure VII

### Part "B" - Statement pursuant to Section 129 (3) of the Companies Act, 2013 related to Associate Companies and Joint Ventures

Sr. no.	Name of Associates / Joint Ventures	Shares of Associate/Joint Ventures held by the company on the year end				Profit/Loss for the year			
		Latest Audited Balance Sheet Date	Number	Amount of investment (Carrying Value) in Associates / Joint Venture (Rs. in crore)	Extent of Holding % attributable	Networth to Shareholding as per latest audited balance sheet (Rs. in Crore)	Considered in consolidation (Rs. in Crore)	Not considered in consolidation	Description of how there is significant influence
<b>Associates</b>									
1	Aditya Birla Science and Technology Company Private Limited	31-Mar-22	9,800,000	9.80	49.00	55.76	27.32	Note A	
2	Aditya Birla Renewables Subsidiary Limited	31-Mar-22	6,895,200	6.90	26.00	27.70	7.20	Note A	
3	Aditya Birla Renewable Utkal Limited (ABRUL)	31-Mar-22	1,274,000	1.27	26.00	5.26	1.37	Note A	
4	Aditya Birla Renewable Solar Limited	31-Mar-22	8,307,000	8.31	26.00	33.97	8.83	Note A	
5	Associates of Novelis Inc. @		3,001	2.12	-	(1.48)	0.10		
<b>Joint Ventures</b>									
1	Hydromine Global Minerals (GMBH) Limited	31-Mar-22	66,562	1.37	45.00	0.01	0.00	Note A	
2	MNH Shakti Limited	31-Mar-22	5,265,000	5.27	15.00	41.55	6.23	Note A	
<b>Joint Operations</b>									
1	Mahan Coal Limited	31-Mar-22	32,250,000	10.25	50.00	22.73	11.36	Note A	
2	Tubed Coal Mines Limited	31-Mar-22	15,296,700	0.00	60.00	2.76	1.66	Note A	
3	Joint Operations of Novelis Inc. @		10,041	2,119.55		341.19	118.59		
<b>@ - Associates of Novelis Inc.</b>									
	Deutsche Aluminium Verpackung Recycling GmbH	31-Dec-21	1	1.74	30%	(1.53)	(0.00)	Equity	
	France Aluminium Recyclage SA	31-Dec-21	3,000	0.38	20%	0.05	0.10	Equity	
<b>@ - Joint Operations of Novelis Inc.</b>									
	Aluminium Norf GmbH	31-Dec-21	1	258.06	50%	187.55	45.12	Equity	
	Logan Aluminium Inc.	31-Mar-22	40	0.00	40%	13.90	1.13	Consolidated	
	AluInfra Services SA	31-Dec-20	5,000	24.06	50%	0.52	0.20	Equity	
	Ulsan Aluminium Ltd.	31-Mar-21	5,000	1,837.42	50%	139.22	72.15	Equity	

**Note A** - There is significant influence due to percentage holding of share capital

For and on behalf of the Board of **Hindalco Industries Limited**

**Praveen Kumar Maheshwari**

Whole-time Director and Chief Financial Officer  
DIN-00174361

**Anil Malik**

Company Secretary

**Satish Pai**

Managing Director  
DIN-06646758

**K N Bhandari**

Director  
DIN-00026078

Place: Mumbai  
Date: May 26, 2022

## Independent Auditor's Report on the Standalone Financial Statements

To the Members of Hindalco Industries Limited

Report on the Audit of the Standalone Financial Statements

### Opinion

- We have audited the accompanying standalone financial statements of Hindalco Industries Limited ("the Company"), which comprise the Standalone Balance Sheet as at March 31, 2022, and the Standalone Statement of Profit and Loss (including Other Comprehensive loss), the Standalone Statement of Changes in Equity and the Standalone Statement of Cash Flows for the year then ended, and notes to the standalone financial statements, including a summary of significant accounting policies and other explanatory information in which are included the financial statement/financial information as at March 31, 2022 and for the year then ended in respect of two Joint Operations consolidated on a proportionate basis and two Trusts (Refer note 55 to the standalone financial statements) (hereinafter referred to as "standalone financial statements").
- In our opinion and to the best of our information and according to the explanations given to us and based on the consideration of reports of other auditors on audited financial statements of the joint operations and based on the consideration of the separate unaudited financial information of the trusts, the aforesaid standalone financial statements give the information required by the Companies Act, 2013 ("the Act") in the manner so required and give a true and fair view in conformity with the accounting principles generally accepted in India, of the state of affairs of the Company, its joint operations and its trusts as at March 31, 2022, and total comprehensive income (comprising of profit and other comprehensive loss), changes in equity and its cash flows for the year then ended.

### Basis for Opinion

- We conducted our audit in accordance with the Standards on Auditing (SAs) specified under Section 143(10) of the Act. Our responsibilities under those Standards are further described in the "Auditor's responsibilities for the audit of the standalone financial statements" section of our report. We are independent of the Company in accordance with the Code of Ethics issued by the Institute of Chartered Accountants of India together with the ethical requirements that are relevant to our audit of the standalone financial statements under the provisions of the Act and the Rules thereunder, and we have fulfilled our other ethical responsibilities in accordance with these requirements and the Code of Ethics. We believe that the audit evidence we have obtained and the audit evidence obtained by the other auditors in terms of their reports referred to in sub-paragraph 13 of the Other Matters paragraph below, other than the unaudited financial information as certified by the management and referred to in sub-paragraph 14 of the Other Matters section below, is sufficient and appropriate to provide a basis for our opinion.

### Key audit matters

- Key audit matters are those matters that, in our professional judgment, were of most significance in our audit of the standalone financial statements of the current period. These matters were addressed in the context of our audit of the standalone financial statements as a whole and in forming our opinion thereon, and we do not provide a separate opinion on these matters.

### Key audit matter

### How our audit addressed the key audit matter

#### A. Measurement of inventory quantities of coal, bauxite, copper concentrate and work in progress consisting of precious metals

Refer Notes 1D (j) and 11 (d) to the standalone financial statements.

Of the Company's ₹ 20,948 crores of inventory as at March 31, 2022, ₹ 4,302 crores of inventory comprised of coal, bauxite, copper concentrate and work in progress consisting of precious metals.

This was determined a key audit matter, as the measurement of these inventory quantities lying at the Company's yards, smelters and refineries is complex and involves significant judgement and estimate resulting from measuring the surface area, dip measurement of materials in tanks/silos and such other parameters.

The Company uses internal and external experts, as applicable, to perform volumetric surveys and assessments basis which the quantities of these inventories are estimated.

Our audit procedures relating to the measurement of inventory quantities of coal, bauxite, copper concentrate and work in progress of precious metals included the following:

- Understanding and evaluating the design and testing the operating effectiveness of controls over the physical count process and measurement of such inventory;
- Evaluation of the independence competency and capabilities of the management's experts;
- Physically observing inventory measurement and count procedures carried out by management using experts, to assess its appropriateness and completeness and performing roll forward procedures; and
- Obtaining and inspecting inventory measurement and physical count results for such inventories, including assessing and evaluating the results of analysis performed by management in respect of differences between book and physical quantities.

Based on the above procedures performed, we did not identify any material exceptions in the measurement of inventory quantities of coal, bauxite, copper concentrate and work in progress inventories consisting of precious metals.



# Independent Auditor's Report

## on the Standalone Financial Statements

Key audit matter	How our audit addressed the key audit matter
<p><b>B. Provisions recognised and contingencies disclosed with regard to certain legal and tax matters including uncertain tax positions.</b></p> <p>Refer Notes 1D (i), 10, 22, 23 and 44 to the standalone financial statements.</p> <p>The Company operate in a complex tax jurisdiction with certain tax exemption/ deduction that may be subject to challenge and audit by the tax authorities. There are open tax matters under litigation with tax authorities. As at March 31, 2022, the Company has, recognised provisions and disclosed contingent liabilities towards various legal and tax matters. There are number of legal, direct and indirect tax cases against the Company, including environmental, mining, local and state levies, income tax holidays, availing of input tax credits and such other matters.</p> <p>This is a key audit matter, as evaluation of these matters requires management judgement and estimation, related legal advice including those leading to interpretation of laws and regulations and application of relevant judicial precedents to determine the probability of the outflow of economic resources for recognising provisions, disclosing contingent liabilities and making related disclosures in the standalone financial statements.</p>	<p>Our audit procedures relating to provisions recognised and contingencies disclosed with regard to certain legal and tax matters included the following:</p> <ul style="list-style-type: none"> <li>• Understanding and evaluating the design and testing the operating effectiveness of controls over the recognition, measurement, presentation and disclosures made in the standalone financial statements in respect of these matters;</li> <li>• Obtaining details of legal and tax matters, inspecting the supporting documents to evaluate management's assessment of probability of outcome and the magnitude of potential loss, and testing related to provisions and disclosures in the standalone financial statements through inquiries with the management and legal counsel;</li> <li>• Assessing on test basis on the underlying calculation supporting the contingent liability and other litigations disclosures in the standalone financial statements;</li> <li>• Reviewing orders and other communication from tax and regulatory authorities and management responses thereto;</li> <li>• Assessing the management expert's legal advice and opinion, as applicable, obtained by the Company's management to corroborate management assessment and evaluating competence and capabilities of the experts; and</li> <li>• Using auditor's specialist for technical assistance in evaluating certain significant and judgemental complex direct and indirect tax litigation and positions in tax returns and their possible outcome.</li> </ul> <p>Based on the above procedures performed, we did not identify any material exceptions in the provisions recognised and contingent liabilities disclosed in the standalone financial statements with regard to such legal and tax matters.</p>
<p><b>C. Accounting of derivatives and hedging transactions</b></p> <p>Refer Notes 1B (Q) and 49 to the standalone financial statements.</p> <p>Company's financial performance is significantly impacted by fluctuations in prices of aluminium, copper, gold, silver, furnace oil and foreign exchange rates. The Company takes a structured approach to the identification, quantification and hedging of such risks by using various derivatives (e.g. forwards, futures, options and embedded derivatives) in commodities and/or foreign currencies. These hedges are designated as either cash flow or fair value hedges, and in certain cases remains non-designated.</p> <p>As at March 31, 2022, the carrying value of the Company's derivatives included derivative assets amounting to Rs. 681 crores and derivative liabilities amounting to Rs. 3,763 crores.</p>	<p>Our audit procedures related to accounting of derivatives and hedging transactions included the following:</p> <ul style="list-style-type: none"> <li>• Understanding and evaluating the design and testing the operating effectiveness of controls over accounting of derivatives and hedging transactions;</li> <li>• Testing qualifying criteria for hedge accounting in accordance with Ind AS 109, including: <ul style="list-style-type: none"> <li>✓ Understanding the risk management objectives and strategies for different types of hedging programs;</li> <li>✓ Evaluating that the hedging relationship consists only of eligible hedging instruments and hedged items;</li> <li>✓ Using auditor's expert for assistance in verifying hedge effectiveness requirements of Ind AS 109, Financial Instruments, including the economic relationship between the hedged item and the hedging instrument.</li> </ul> </li> <li>• Testing appropriateness of hedge accounting to qualified hedge relationships i.e. cash flow and fair value hedges; and</li> </ul>

Key audit matter	How our audit addressed the key audit matter
<p>Derivative and hedge accounting is considered a key audit matter because of its significance to the standalone financial statements, the volume, nature and types of hedging relationships, including complexity involved in the application of hedge accounting principles in accordance with Ind AS 109, Financial Instruments.</p>	<ul style="list-style-type: none"> <li>• Testing related presentation and disclosures in the standalone financial statements.</li> </ul> <p>Based on the above procedures performed, we did not identify any material exceptions in the amounts, presentation and disclosures made in the standalone financial statements relating to accounting of derivatives and hedging transactions.</p>

### Other Information

5. The Company's Board of Directors is responsible for the other information. The other information comprises the information included in the annual report, but does not include the financial statements and our auditor's report thereon. The annual report is expected to be made available to us after the date of this auditor's report.

Our opinion on the standalone financial statements does not cover the other information and we will not express any form of assurance conclusion thereon.

In connection with our audit of the standalone financial statements, our responsibility is to read the other information identified above when it becomes available and, in doing so, consider whether the other information is materially inconsistent with the standalone financial statements or our knowledge obtained in the audit, or otherwise appears to be materially misstated.

When we read the annual report, if we conclude that there is a material misstatement therein, we are required to communicate the matter to those charged with governance and take appropriate action as applicable under the relevant laws and regulations.

### Responsibilities of management and those charged with governance for the standalone financial statements

6. The Company's Board of Directors is responsible for the matters stated in Section 134(5) of the Act with respect to the preparation of these standalone financial statements that give a true and fair view of the financial position, financial performance, changes in equity and cash flows of the Company in accordance with the accounting principles generally accepted in India, including the Accounting Standards specified under Section 133 of the Act. This responsibility also includes maintenance of adequate accounting records in accordance with the provisions of the Act for safeguarding of the assets of the Company, and for preventing and detecting frauds and other irregularities; selection and application of appropriate accounting policies; making judgments and estimates that are reasonable and prudent; and design, implementation and maintenance of adequate internal financial controls, that were operating effectively for ensuring the accuracy

and completeness of the accounting records, relevant to the preparation and presentation of the standalone financial statements that give a true and fair view and are free from material misstatement, whether due to fraud or error.

7. In preparing the financial statements, management is responsible for assessing the Company's ability to continue as a going concern, disclosing, as applicable, matters related to going concern and using the going concern basis of accounting unless management either intends to liquidate the Company or to cease operations, or has no realistic alternative but to do so. Those Board of Directors are also responsible for overseeing the Company's financial reporting process.

### Auditor's responsibilities for the audit of the standalone financial statements

8. Our objectives are to obtain reasonable assurance about whether the standalone financial statements as a whole are free from material misstatement, whether due to fraud or error, and to issue an auditor's report that includes our opinion. Reasonable assurance is a high level of assurance but is not a guarantee that an audit conducted in accordance with SAs will always detect a material misstatement when it exists. Misstatements can arise from fraud or error and are considered material if, individually or in the aggregate, they could reasonably be expected to influence the economic decisions of users taken on the basis of these standalone financial statements.
9. As part of an audit in accordance with SAs, we exercise professional judgment and maintain professional skepticism throughout the audit. We also:
- Identify and assess the risks of material misstatement of the standalone financial statements, whether due to fraud or error, design and perform audit procedures responsive to those risks, and obtain audit evidence that is sufficient and appropriate to provide a basis for our opinion. The risk of not detecting a material misstatement resulting from fraud is higher than for one resulting from error, as fraud may involve collusion, forgery, intentional

# Independent Auditor's Report

## on the Standalone Financial Statements

omissions, misrepresentations, or the override of internal control.

- Obtain an understanding of internal control relevant to the audit in order to design audit procedures that are appropriate in the circumstances. Under Section 143(3)(i) of the Act, we are also responsible for expressing our opinion on whether the Company has adequate internal financial controls with reference to standalone financial statements in place and the operating effectiveness of such controls.
  - Evaluate the appropriateness of accounting policies used and the reasonableness of accounting estimates and related disclosures made by management.
  - Conclude on the appropriateness of management's use of the going concern basis of accounting and, based on the audit evidence obtained, whether a material uncertainty exists related to events or conditions that may cast significant doubt on the Company's ability to continue as a going concern. If we conclude that a material uncertainty exists, we are required to draw attention in our auditor's report to the related disclosures in the standalone financial statements or, if such disclosures are inadequate, to modify our opinion. Our conclusions are based on the audit evidence obtained up to the date of our auditor's report. However, future events or conditions may cause the Company to cease to continue as a going concern.
  - Evaluate the overall presentation, structure and content of the standalone financial statements, including the disclosures, and whether the standalone financial statements represent the underlying transactions and events in a manner that achieves fair presentation.
  - Obtain sufficient appropriate audit evidence regarding the financial information of the entities or business activities within the Company to express an opinion on the standalone financial statements. We are responsible for the direction, supervision and performance of the audit of the financial statements of such entities included in the standalone financial statements of which we are the independent auditors. For the other entities included in the standalone financial statements, which have been audited by other auditors, such other auditors remain responsible for the direction, supervision and performance of the audits carried out by them. We remain solely responsible for our audit opinion.
10. We communicate with those charged with governance regarding, among other matters, the planned scope and timing of the audit and significant audit findings, including

any significant deficiencies in internal control that we identify during our audit.

11. We also provide those charged with governance with a statement that we have complied with relevant ethical requirements regarding independence, and to communicate with them all relationships and other matters that may reasonably be thought to bear on our independence, and where applicable, related safeguards.
12. From the matters communicated with those charged with governance, we determine those matters that were of most significance in the audit of the standalone financial statements of the current period and are therefore the key audit matters. We describe these matters in our auditor's report unless law or regulation precludes public disclosure about the matter or when, in extremely rare circumstances, we determine that a matter should not be communicated in our report because the adverse consequences of doing so would reasonably be expected to outweigh the public interest benefits of such communication.

### Other Matters

13. We did not audit the financial statements of two joint operations included in the standalone financial statements of the Company, which constitute total assets of ₹ 26 crores and net assets of ₹ 25 crores as at March 31, 2022, total revenue from operations of ₹ Nil, total comprehensive loss (comprising of loss after tax and other comprehensive income) of ₹ \* crore and net cash inflows amounting to ₹ \* crore for the year ended on that date. These financial statements and other financial information have been audited by other auditors whose reports have been furnished to us by the Management, and our opinion on the standalone financial statements insofar as it relates to the amounts and disclosures included in respect of these joint operations and our report in terms of sub-section (3) of Section 143 of the Act including report on Other Information insofar as it relates to the aforesaid joint operations, is based solely on the reports of the other auditors. Material uncertainty related to going concern has been reported by two joint operations during the year which are not material to the Company.

\* represent figures below the rounding convention used in the financial statements

14. We did not audit the financial information of two Trusts included in the standalone financial statements of the Company, which constitute total assets of ₹ 245 crores and net assets of ₹ 37 crores as at March 31, 2022, total revenue from operations of ₹ Nil, total comprehensive income (comprising of profit after tax and other comprehensive income) of ₹ 1 crore and net cash inflows amounting to

₹ 11 crores for the year then ended. The unaudited financial information in respect of these Trusts have been furnished to us by the management, and our opinion on the standalone financial statements in so far as it relates to the amounts and disclosures included in respect of these Trusts, and our report in terms of sub-section (3) of Section 143 of the Act to the extent applicable, is based solely on such unaudited financial information. In our opinion and according to the information and explanations given to us by the Management, these financial information are not material to the Company.

Our opinion on the standalone financial statements, and our report on Other Legal and Regulatory Requirements below, is not modified in respect of the above matters with respect to our reliance on the work done and the reports of the other auditors and the financial information certified by the Management.

### Report on other legal and regulatory requirements

15. As required by the Companies (Auditor's Report) Order, 2020 ("the Order"), issued by the Central Government of India in terms of sub-section (11) of Section 143 of the Act, we give in the "Annexure A" a statement on the matters specified in paragraphs 3 and 4 of the Order, to the extent applicable.
16. As required by Section 143(3) of the Act, we report that:
- (a) We have sought and obtained all the information and explanations which to the best of our knowledge and belief were necessary for the purposes of our audit.
  - (b) In our opinion, proper books of account as required by law have been kept by the Company so far as it appears from our examination of those books and the reports of the other auditors of two joint operations.
  - (c) The Standalone Balance Sheet, the Standalone Statement of Profit and Loss (including other comprehensive loss), the Standalone Statement of Changes in Equity and the Standalone Statement of Cash Flows dealt with by this Report are in agreement with the relevant books of account.
  - (d) In our opinion, the aforesaid standalone financial statements comply with the Accounting Standards specified under Section 133 of the Act.
  - (e) On the basis of the written representations received from the directors as on March 31, 2022 taken on record by the Board of Directors of the Company and the reports of the statutory auditors of its joint operations incorporated in India, none of the

directors is disqualified as on March 31, 2022 from being appointed as a director in terms of Section 164(2) of the Act.

- (f) With respect to the adequacy of the internal financial controls with reference to standalone financial statements of the Company and, its joint operations incorporated in India and the operating effectiveness of such controls, refer to our separate Report in "Annexure B".
- (g) With respect to the other matters to be included in the Auditor's Report in accordance with Rule 11 of the Companies (Audit and Auditors) Rules, 2014 (as amended), in our opinion and to the best of our information and according to the explanations given to us:
  - i. The standalone financial statements disclose the impact of pending litigations on the standalone financial position of the Company and its joint operations—Refer Notes 22, 23 and 44 to the standalone financial statements;
  - ii. Provision has been made in the standalone financial statements, as required under the applicable law or accounting standards, for material foreseeable losses, if any, on long-term contracts including derivative contracts as at March 31, 2022—Refer Notes 22 and 49 to the standalone financial statements in respect of such items as it relates to the Company and its joint operations;
  - iii. Except as referred to in Note 21B to the standalone financial statements, there has been no delay in transferring amounts, required to be transferred, to the Investor Education and Protection Fund by the Company.
  - iv. (a) The respective management of the Company and its joint operations which are companies incorporated in India whose financial statements have been audited under the Act, have represented to us and the other auditors of such joint operations, respectively, that, to the best of its knowledge and belief, as disclosed in the notes to the accounts, no funds have been advanced or loaned or invested (either from borrowed funds or share premium or any other sources or kind of funds) by the Company or any of such joint operations to or in any other persons or entities, including foreign entities ("Intermediaries"), with the understanding,



## Independent Auditor's Report on the Standalone Financial Statements

- whether recorded in writing or otherwise, that the Intermediary shall, whether, directly or indirectly, lend or invest in other persons or entities identified in any manner whatsoever by or on behalf of the Company or any of such Joint Operations ("Ultimate Beneficiaries") or provide any guarantee, security or the like on behalf of the Ultimate Beneficiaries (Refer Note 56(C) to the standalone financial statements);
- (b) The respective management of the Company and its joint operations which are companies incorporated in India whose financial statements have been audited under the Act, have represented to us and the other auditors of such joint operations respectively that, to the best of its knowledge and belief, as disclosed in the notes to the accounts, no funds have been received by the Company or any of such joint operations from any persons or entities, including foreign entities ("Funding Parties"), with the understanding, whether recorded in writing or otherwise, that the Company or any of such Joint Operations shall, whether, directly or indirectly, lend or invest in other persons or entities identified in any manner whatsoever by or on behalf of the Funding Party ("Ultimate Beneficiaries") or provide any guarantee, security or the like on behalf of the Ultimate Beneficiaries (Refer Note 56(C) to the standalone financial statements); and
- (c) Based on such audit procedures that has been we considered reasonable and appropriate in the circumstances, performed by us and those performed by the auditors of the joint operations which are companies incorporated in India whose financial statements have been audited under the Act nothing has come to our or other auditor's notice that has caused us or the other auditors to believe that the representations under sub-clauses (a) and (b) contain any material misstatement.
- v. The dividend declared and paid during the year by the Company is in compliance with Section 123 of the Act. The joint operations have not declared or paid any dividend during the year.
17. The Company and its joint operations incorporated in India has paid/ provided for managerial remuneration in accordance with the requisite approvals mandated by the provisions of Section 197 read with Schedule V to the Act.

For Price Waterhouse & Co Chartered Accountants LLP  
Firm Registration Number: 304026E/ E-300009

**Sarah George**  
Partner  
Membership Number: 045255  
UDIN: 22045255AJPZYN4652

Mumbai  
May 26, 2022

## Annexure A to Independent Auditor's Report

Referred to in paragraph 15 of the Independent Auditor's Report of even date to the members of Hindalco Industries Limited on the standalone financial statements as of and for the year ended March 31, 2022

- i. (a) (A) The Company is maintaining proper records showing full particulars, including quantitative details and situation, of Property, Plant and Equipment.
- (B) The Company is maintaining proper records showing full particulars of Intangible Assets.
- (b) The Property, Plant and Equipment are physically verified by the Management according to a phased programme designed to cover all the items over a period of 3 years which, in our opinion, is reasonable having regard to the size of the Company and the nature of its assets. Pursuant to the programme, a portion of the Property, Plant and Equipment has been physically verified by the Management during the year and no material discrepancies have been noticed on such verification.
- (c) The title deeds of all the immovable properties (other than properties where the Company is the lessee and the lease agreements are duly executed in favour of the lessee), as disclosed in Note 2 on Property, Plant and Equipment, Note 3 on Investment Properties and Note 15 on 'Non-Current Assets classified as Held for Sale' to the standalone financial statements, are held in the name of the Company, except for the following:

Description of property	Gross carrying value (₹ in crores)	Held in the name of	Whether promoter, director or their relative or employee	Period Held - indicate range, where appropriate (Financial year -FY)	Reason for not being held in the name of the Company
Freehold Land (Property, plant and equipment and Investment Property) at Bharuch and Nashik/ Building (Investment Property) at Mumbai	8	Indogulf Fertilizer and Chemicals Corporation Limited	No	Since FY 2002-2003	The title deeds are held in the name of Indogulf Fertilizer and Chemicals Corporation Limited which has subsequently been amalgamated with the Company
Freehold Land (Property, plant and equipment and Rights of Use assets) / Building (Property, plant and equipment) at various locations	10	Indian Aluminium Company Limited	No	Since FY 2004-2005	The title deeds are held in the name of Indian Aluminium Company Limited which has subsequently been amalgamated with the Company
Freehold Land (Property, plant and equipment) at Kuppam	1	SAPA Extrusion India Private Limited	No	Since FY 2021-2022	The title deeds are held in the name of the SAPA Extrusion India Private Limited which has subsequently been acquired by the company. The company is in process of registering the title deed of this land in its name.
Freehold Land (Property, plant and equipment) at Mahan unit	4	Various individual landowners	No	Since FY 2013 -2014	Certain original land-related documents held in the name of original landowners were submitted to the bank that had provided borrowing for the Mahan project. These original documents are required to be submitted to the land department in order to get the title deed registered in the name of the Company. The Company is awaiting receipt of these original land-related documents from the bank to initiate the process of transfer of the title of the land in favour of the Company.



## Annexure A to Independent Auditor's Report

Description of property	Gross carrying value (₹ in crores)	Held in the name of	Whether promoter, director or their relative or employee	Period Held - indicate range, where appropriate (Financial year -FY)	Reason for not being held in the name of the Company
Freehold Land (Property, plant and equipment) at Kathautia mine	27	Various individual landowners	No	Since FY 2018 -2019	Approval of the District collector is awaited which is a prerequisite as per the Chota Nagpur Tenancy Act, 1908 to transfer the title deed in the name of the company. The company is in the process of obtaining these approvals.

(d) The Company has not revalued its Property, Plant and Equipment (including Right of Use assets) or intangible assets or both during the year. Consequently, the question of our commenting on whether the revaluation is based on the valuation by a Registered Valuer, or specifying the amount of change, if the change is 10% or more in the aggregate of the net carrying value of each class of Property, Plant and Equipment (including Right of Use assets) or intangible assets does not arise.

(e) Based on the information and explanations furnished to us, no proceedings have been initiated on or are pending against the Company for holding benami property under the Prohibition of Benami Property Transactions Act, 1988 (as amended in 2016) (formerly the Benami Transactions (Prohibition) Act, 1988 (45 of 1988)) and Rules made thereunder, and therefore the question of our commenting on whether the Company has appropriately disclosed the details in its standalone financial statements does not arise.

ii. (a) The physical verification of inventory excluding stocks with third parties has been conducted at reasonable intervals by the Management during the year and, in our opinion, the coverage and procedure of such verification by Management is appropriate. In respect of inventory lying with third parties, these have substantially been confirmed by them. The discrepancies noticed on physical verification of inventory as compared to book records were not 10% or more in aggregate for each class of inventory.

(b) During the year, the Company has been sanctioned working capital limits in excess of ₹ 5 crores, in aggregate, from banks on the basis of security of current assets. In our opinion, the quarterly returns or statements filed by the Company including revised returns or statements filed with such banks are in

agreement with the unaudited books of account of the Company.

The Company has filed provisional statement with the bank for the quarter ended March 31, 2022, with respect to Company's Aluminium division and the final statement will be submitted to the bank upon finalization of the audited financial statements.

(Also refer Note 56C to the standalone financial statements).

iii. (a) The Company has made investments in four companies and granted unsecured loans to two companies and 225 other parties representing loan to employees. The aggregate amount during the year, and balance outstanding at the balance sheet date with respect to such loans to subsidiaries and to parties other than subsidiaries are as per the table given below:

(₹ in crores)		
Particulars	Aggregate amount of loan granted/ provided during the year *	Balance outstanding as a balance sheet date in respect of these cases*
Subsidiaries	200	169
Others	3	3

\*excludes loan provided to Hindalco Employee Welfare Trust for providing share based payments to employees of the Company.

(Also refer Note 8 and Note 43 to the standalone financial statements)

(b) In respect of the aforesaid investments/loans, the terms and conditions under which such loans were granted/investments were made are not prejudicial to the Company's interest.

(c) In respect of the aforesaid loans, the schedule of repayment of principal and payment of interest has been stipulated, and the parties are repaying the

principal amounts, as stipulated, and are also regular in payment of interest as applicable.

(d) In respect of the aforesaid loans, there is no amount which is overdue for more than ninety days.

(e) There were no loans which fell due during the year and were renewed/extended. Further, no fresh loans were granted to same parties to settle the existing overdue loans.

(f) The loans granted during the year, including to related parties had stipulated the scheduled repayment of principal and payment of interest and the same were not repayable on demand.

iv. In our opinion, and according to the information and explanations given to us, the Company has complied with the provisions of Sections 185 and 186 of the Companies Act, 2013 ('the Act') in respect of the loans and investments made, and guarantees and security provided by it.

v. The Company has not accepted any deposits or amounts which are deemed to be deposits from the public within the meaning of Sections 73, 74, 75 and 76 of the Act and the Rules framed there under to the extent notified.

vi. Pursuant to the rules made by the Central Government of India, the Company is required to maintain cost records as specified under Section 148(1) of the Act in respect of its products. We have broadly reviewed the same, and are

of the opinion that, prima facie, the prescribed accounts and records have been made and maintained. We have not, however, made a detailed examination of the records with a view to determine whether they are accurate or complete.

vii. (a) According to the information and explanations given to us and the records of the Company examined by us, in our opinion, the Company is generally regular in depositing the undisputed statutory dues in respect of goods and services tax and income tax, though there has been a slight delay in a few cases, and is regular in depositing undisputed statutory dues, including provident fund, employees state insurance, sales tax, service tax, duty of customs, duty of excise, value added tax, cess, and other material statutory dues, as applicable, with the appropriate authorities. Also, refer note 31 to the standalone financial statements regarding management's assessment on certain matters relating to provident fund.

(b) According to the information and explanations given to us and the records of the Company examined by us, there are no statutory dues of provident fund as referred to in sub-clause (a) which have not been deposited on account of any dispute. The particulars of other statutory dues referred to in sub-clause (a) as at March 31, 2022 which have not been deposited on account of a dispute, are as follows:

Name of the statute	Nature of dues	Amount (₹ in crore) #	Period to which the amount relates	Forum where the disputes are pending
Central Sales Tax Act and Local Sales Tax (including VAT) Act	Sales Tax	34	1995-2010, 2014-2016	Assistant Commissioner/Deputy Commissioner /Commissioner/ Revisionary Authorities/ Joint Commissioner (A) /Additional Commissioner (A)
		5	2002-2007, 2009-2011	Tribunal
		33	1999-2007, 2012-2013	High Court
The Central Excise Act, 1944	Excise Duty	20	2000-2003, 2008-2009, 2012-2018	Assistant Commissioner/ Commissioner/ Revisionary Authorities/ Commissioner (A)
		1,098	2001-2018	Customs, Excise and Service Tax Appellate Tribunal (CESTAT)
		10	2001-2008	High Court
		3	2014-2016	Supreme Court
	Clean environment cess	17	2017-2018	Customs, Excise and Service Tax Appellate Tribunal (CESTAT)

## Annexure A to Independent Auditor's Report

Name of the statute	Nature of dues	Amount (₹ in crore) #	Period to which the amount relates	Forum where the disputes are pending
The Customs Act, 1962	Custom Duty	3	2004-2005, 2017-2021	Commissioner (Appeal)
		1	2004-2005, 2016-2017	Customs, Excise and Service Tax Appellate Tribunal (CESTAT)
The Service Tax under the Finance Act, 1994	Service Tax	9	2008-2013, 2016-2018	Assistant Commissioner/ Commissioner/ Revisionary Authorities/ Commissioner (A)
		402	2004-2018	Customs, Excise and Service Tax Appellate Tribunal (CESTAT)
		16	2013-2016	High Court
The Central Goods and Service Tax Act, 2017	Goods and Services Tax	59	2016-2019, 2021-2022	Assistant Commissioner/Commissioner (A)/ Joint Commissioner
		27	2016-2021	High Court
Income Tax Act, 1961	Income Tax	19	2015-2017	Commissioner of Income Tax Appeals
Building and Other Construction Workers Welfare Cess Act, 1996	BOCW Cess	191	2008-2018	State Labour Commissioner
Mines and Minerals (Development and Regulation) Act, 1957	Royalty	28	1991-2011	Certificate Officer
Orissa Entry Tax, 1999	Entry Tax	76	2003-2018	High Court
Uttar Pradesh Tax on Entry of Goods into Local Areas Act, 2007	Entry Tax	20	2006-2008	High Court
		87	2000-2012	Supreme Court
Uttar Pradesh Stamp Act	Stamp Duty	253	2006-2007	High Court
Indian Stamp Act, 1899	Stamp Duty	*	2003-2004	High Court
The Employees State Insurance Act, 1948	Employees State Insurance	*	2004-2005	Employees State Insurance Court
Transit Permit Pass Regulation, 1973	Transit Permit Pass	1	2006-07	High Court
Uttar Pradesh Kshetra Panchayat and Zila Panchayat Adhinyam, 1961	Toll Tax	54	2003-2004, 2016-2017	High Court

# above amounts are net of payments made under protest.

\* Represents figures below the rounding off convention used in this report.

- viii. According to the information and explanations given to us and the records of the Company examined by us, there are no transactions in the books of account that has been surrendered or disclosed as income during the year in the tax assessments under the Income Tax Act, 1961, that has not been recorded in the books of account.
- ix. (a) According to the records of the Company examined by us and the information and explanation given to us, the Company has not defaulted in repayment of loans or other borrowings or in the payment of interest to any lender during the year.
- (b) According to the information and explanations given to us and on the basis of our audit procedures, we report that the Company has not been declared willful defaulter by any bank or financial institution or government or any government authority.
- (c) In our opinion, and according to the information and explanations given to us, the term loans have been applied for the purposes for which they were obtained. (Also refer Note 56C to the standalone financial statements)
- (d) According to the information and explanations given to us, and the procedures performed by us, and on an overall examination of the standalone financial statements of the company, we report that no funds raised on short-term basis have been used for long-term purposes by the company.
- (e) According to the information and explanations given to us and on an overall examination of the standalone financial statements of the Company, we report that the Company has not taken any funds from any entity or person on account of or to meet the obligations of its subsidiaries, associates or joint ventures.
- (f) According to the information and explanations given to us and procedures performed by us, we report that the Company has not raised loans during the year on the pledge of securities held in its subsidiaries, joint ventures or associate companies.
- (x) (a) The Company has not raised any money by way of initial public offer or further public offer (including debt instruments) during the year. Accordingly, the reporting under Clause 3(x)(a) of the Order are not applicable to the Company.
- (b) The Company has not made any preferential allotment or private placement of shares or fully or partially or optionally convertible debentures during the year. Accordingly, the reporting under Clause 3(x)(b) of the Order are not applicable to the Company.
- (xi) (a) During the course of our examination of the books and records of the Company, carried out in accordance with the generally accepted auditing practices in India, and according to the information and explanations given to us, we have neither come across any instance of material fraud by the Company or on the Company, noticed or reported during the year, nor have we been informed of any such case by the Management.
- (b) During the course of our examination of the books and records of the Company, carried out in accordance with the generally accepted auditing practices in India, and according to the information and explanations given to us, a report under Section 143(12) of the Act, in Form ADT-4, as prescribed under rule 13 of Companies (Audit and Auditors) Rules, 2014 was not required to be filed with the Central Government. Accordingly, the reporting under clause 3(xi)(b) of the Order is not applicable to the Company.
- (c) During the course of our examination of the books and records of the Company, carried out in accordance with the generally accepted auditing practices in India, and according to the Information and explanations given to us, the Company has received whistle-blower complaints during the year which have been considered by us for any bearing on our audit and reporting.
- (xii) As the Company is not a Nidhi Company and the Nidhi Rules, 2014 are not applicable to it, the reporting under Clause 3(xii) of the Order are not applicable to the Company.
- (xiii) The Company has entered into transactions with related parties in compliance with the provisions of Sections 177 and 188 of the Act. The details of such related party transactions have been disclosed in the standalone financial statements as required under Indian Accounting Standard 24 "Related Party Disclosures" specified under Section 133 of the Act.
- (xiv) (a) In our opinion and according to the information and explanation given to us, the Company has an internal audit system commensurate with the size and nature of its business.
- (b) The reports of the Internal Auditor for the period under audit have been considered by us.

## Annexure A to Independent Auditor’s Report

- (xv) The Company has not entered into any non-cash transactions with its directors or persons connected with them. Accordingly, the reporting on compliance with the provisions of Section 192 of the Act under clause 3(xv) of the Order is not applicable to the Company.
- (xvi) (a) The Company is not required to be registered under Section 45-IA of the Reserve Bank of India Act, 1934. Accordingly, the reporting under Clause 3(xvi)(a) of the Order is not applicable to the Company.
- (b) The Company has not conducted non-banking financial / housing finance activities during the year. Accordingly, the reporting under Clause 3(xvi)(b) of the Order is not applicable to the Company.
- (c) The Company is not a Core Investment Company (CIC) as defined in the regulations made by the Reserve Bank of India. Accordingly, the reporting under Clause 3(xvi)(c) of the Order is not applicable to the Company.
- (d) Based on the information and explanations provided by the management of the Company, the Group has five CICs as part of the Group. We have not, however, separately evaluated whether the information provided by the management is accurate and complete.
- (xvii) The Company has not incurred any cash losses in the financial year or in the immediately preceding financial year.
- (xviii) There has been no resignation of the statutory auditors during the year and accordingly the reporting under Clause (xviii) is not applicable.

- (xix) According to the information and explanations given to us and on the basis of the financial ratios (Also refer Note 54 to the standalone financial statements), ageing and expected dates of realisation of financial assets and payment of financial liabilities, other information accompanying the standalone financial statements, our knowledge of the Board of Directors and management plans and based on our examination of the evidence supporting the assumptions, nothing has come to our attention, which causes us to believe that any material uncertainty exists as on the date of the audit report that Company is not capable of meeting its liabilities existing at the date of balance sheet as and when they fall due within a period of one year from the balance sheet date. We, however, state that this is not an assurance as to the future viability of the company. We further state that our reporting is based on the facts up to the date of the audit report and we neither give any guarantee nor any assurance that all liabilities falling due within a period of one year from the balance sheet date, will get discharged by the company as and when they fall due.
- (xx) As at balance sheet date, the Company does not have any amount remaining unspent under Section 135(5) of the Act. Accordingly, reporting under clause 3(xx) of the Order is not applicable.
- (xxi) As required by paragraph 3(xxii) of the CARO 2020, we report that the auditors of the following joint operations, which are companies incorporated in India, have given qualification or adverse remarks in their CARO report on the standalone financial statements of the respective joint operation companies which are consolidated in standalone financial statements of the Company:

Sr. No.	Name of the Company	CIN	Relationship with the Holding Company	Date of the respective auditors' report	Paragraph number and comment in the respective CARO report reproduced below:
1	Mahan Coal Limited	U01010MP2006PLC018586	Joint Operation	May 17, 2022	xiv. The Company did not have an internal audit system for the year under Audit.xvii. The Company has incurred cash losses during the current financial year as well as in the immediately preceding financial year. The amount of cash loss during the current year is ₹ 3,361.71 and ₹ 38,615.09 in the immediately preceding financial year.

Sr. No.	Name of the Company	CIN	Relationship with the Holding Company	Date of the respective auditors' report	Paragraph number and comment in the respective CARO report reproduced below:
2	Tubed Coal Mines Limited	U10100MH2007PLC174466	Joint Operation	May 23, 2022	vii. (a). According to the information and explanations given to us and based on our examination of the books of accounts, the Company does not have any undisputed statutory dues related to of Provident Fund, Employees' State Insurance, Sales Tax, Customs Duty, Excise Duty, VAT and GST as on 31st March 2022. However, the Company is regular in depositing Income tax with the appropriate authorities and there are no undisputed amounts payable for the same were outstanding as at March 31, 2022 for a period exceeding six months from the date they became payable. The Company is yet to pay Professional Tax of Rs 4,600 for FY 18-19, Rs 4,600/- for FY 19-20, Rs 4,600/- for FY 20-21 and Rs 3700/- for FY 21-22.xvii. According to the information and explanations given to us and based on our examination of the records of the Company, the Company has incurred cash losses during the financial year covered by our audit and the immediately preceding financial year.

For Price Waterhouse & Co Chartered Accountants LLP  
Firm Registration Number: 304026E/ E-300009

**Sarah George**  
Partner  
Membership Number: 045255  
UDIN: 22045255AJPZYN4652

Mumbai  
May 26, 2022



## Annexure B to Independent Auditor's Report

Referred to in paragraph 16(f) of the Independent Auditor's Report of even date to the members of Hindalco Industries Limited on the standalone financial statements as of and for the year ended March 31, 2022

### Report on the Internal Financial Controls with reference to Standalone Financial Statements under clause (i) of sub-section 3 of Section 143 of the Act

1. We have audited the internal financial controls with reference to standalone financial statements of Hindalco Industries Limited ("the Company") as of March 31, 2022 in conjunction with our audit of the standalone financial statements of the Company for the year ended on that date which includes the internal financial controls over financial reporting of the Company's two joint operations which are companies incorporated in India, as of that date.

### Management's Responsibility for Internal Financial Controls

2. The Company's management is responsible for establishing and maintaining internal financial controls based on the internal control over financial reporting criteria established by the Company considering the essential components of internal control stated in the Guidance Note on Audit of Internal Financial Controls Over Financial Reporting ("the Guidance Note") issued by the Institute of Chartered Accountants of India ("ICAI"). These responsibilities include the design, implementation and maintenance of adequate internal financial controls that were operating effectively for ensuring the orderly and efficient conduct of its business, including adherence to company's policies, the safeguarding of its assets, the prevention and detection of frauds and errors, the accuracy and completeness of the accounting records, and the timely preparation of reliable financial information, as required under the Act.

### Auditor's Responsibility

3. Our responsibility is to express an opinion on the Company's internal financial controls with reference to standalone financial statements based on our audit. We conducted our audit in accordance with the Guidance Note and the Standards on Auditing deemed to be prescribed under Section 143(10) of the Act to the extent applicable to an audit of internal financial controls, both applicable to an audit of internal financial controls and both issued by the ICAI. Those Standards and the Guidance Note require that we comply with ethical requirements and plan and perform the audit to obtain reasonable assurance about whether adequate internal financial controls with reference to standalone financial statements was established and maintained and if such controls operated effectively in all material respects.

4. Our audit involves performing procedures to obtain audit evidence about the adequacy of the internal financial controls system with reference to standalone financial statements and their operating effectiveness. Our audit of internal financial controls with reference to financial statements included obtaining an understanding of internal financial controls with reference to standalone financial statements, assessing the risk that a material weakness exists, and testing and evaluating the design and operating effectiveness of internal control based on the assessed risk. The procedures selected depend on the auditor's judgement, including the assessment of the risks of material misstatement of the financial statements, whether due to fraud or error.

5. We believe that the audit evidence we have obtained and the audit evidence obtained by the other auditors in terms of their reports referred to in the Other Matters paragraph below is sufficient and appropriate to provide a basis for our audit opinion on the Company's internal financial controls system with reference to standalone financial statements.

### Meaning of Internal Financial Controls with reference to financial statements

6. A company's internal financial controls with reference to financial statements is a process designed to provide reasonable assurance regarding the reliability of financial reporting and the preparation of financial statements for external purposes in accordance with generally accepted accounting principles. A company's internal financial controls with reference to financial statements includes those policies and procedures that (1) pertain to the maintenance of records that, in reasonable detail, accurately and fairly reflect the transactions and dispositions of the assets of the company; (2) provide reasonable assurance that transactions are recorded as necessary to permit preparation of financial statements in accordance with generally accepted accounting principles, and that receipts and expenditures of the company are being made only in accordance with authorisations of management and directors of the company; and (3) provide reasonable assurance regarding prevention or timely detection of unauthorised acquisition, use, or disposition of the company's assets that could have a material effect on the financial statements.

### Inherent Limitations of Internal Financial Controls with reference to financial statements

7. Because of the inherent limitations of internal financial controls with reference to financial statements, including the possibility of collusion or improper management override of controls, material misstatements due to error or fraud may occur and not be detected. Also, projections of any evaluation of the internal financial controls with reference to financial statements to future periods are subject to the risk that the internal financial control controls with reference to financial statements may become inadequate because of changes in conditions, or that the degree of compliance with the policies or procedures may deteriorate.

### Opinion

8. In our opinion, the Company and its joint operations, which are companies incorporated in India, has in all material respects, an adequate internal financial controls system with reference to standalone financial statements and such internal financial controls with reference to standalone financial statements were operating effectively as at March 31, 2022, based on the internal control over financial reporting criteria established by

the Company considering the essential components of internal control stated in the Guidance Note issued by the Institute of Chartered Accountants of India.

### Other Matters

9. Our aforesaid report under Section 143(3)(i) of the Act on the adequacy and operating effectiveness of the internal financial controls with reference to financial statements insofar as it relates to two joint operations, which are companies incorporated in India, is based on the corresponding reports of the auditors of such joint operation. Our opinion is not modified in respect of this matter.

For Price Waterhouse & Co Chartered Accountants LLP  
Firm Registration Number: 304026E/ E-300009

### Sarah George

Partner  
Membership Number: 045255  
UDIN: 22045255AJPZYN4652

Mumbai  
May 26, 2022

# Standalone Balance Sheet

as at March 31, 2022

	Note	As at	
		₹ in Crore)	
		31/03/2022	31/03/2021
<b>ASSETS</b>			
<b>Non-Current Assets</b>			
Property, Plant and Equipment (including Right of Use Assets)	2	31,759	32,061
Capital Work-in-Progress	2	1,573	1,587
Investment Properties	3	8	8
Goodwill	4A	4	-
Intangible Assets	4B	529	321
Intangible Assets Under Development	4B	8	122
Financial Assets			
Investment in Subsidiaries	5	16,423	16,794
Investment in Associates and Joint Ventures	6	160	142
Other Investments	7A	8,515	7,437
Loans	8	45	11
Derivatives	49	174	225
Other Financial Assets	9A	232	188
Non-Current Tax Assets (Net)	23	-	-
Other Non-Current Assets	10	760	843
		<b>60,190</b>	<b>59,739</b>
<b>Current Assets</b>			
Inventories	11	20,948	15,989
Financial Assets			
Investments	7B	4,557	7,358
Trade Receivables	12	2,671	1,602
Cash and Cash Equivalents	13	3,405	1,003
Bank Balances other than Cash and Cash Equivalents	14	3,015	16
Loans	8	172	49
Derivatives	49	507	495
Other Financial Assets	9B	1,156	254
Other Current Assets	10	2,433	1,438
		<b>38,864</b>	<b>28,204</b>
Non-Current Assets Held For Sale	15	3	4
		<b>38,867</b>	<b>28,208</b>
		<b>99,057</b>	<b>87,947</b>

	Note	As at	
		₹ in Crore)	
		31/03/2022	31/03/2021
<b>EQUITY AND LIABILITIES</b>			
<b>Equity</b>			
Equity Share Capital	16	222	222
Other Equity	17	54,206	49,842
		<b>54,428</b>	<b>50,064</b>
<b>Liabilities</b>			
<b>Non-Current Liabilities</b>			
Financial Liabilities			
Borrowings	18A	11,668	15,174
Lease Liabilities	2	277	236
Trade Payables	20	-	-
(I) Outstanding dues of micro enterprises and small enterprises;		-	-
(II) Outstanding dues of creditors other than micro enterprises and small enterprises		-	-
Derivatives	49	387	390
Other Financial Liabilities	21A	13	10
Provisions	22	474	421
Deferred Tax Liabilities (Net)	23	2,948	1,966
Other Non-Current Liabilities	25	585	609
		<b>16,352</b>	<b>18,806</b>
<b>Current liabilities</b>			
Financial Liabilities			
Borrowings	18B	7,411	4,755
Lease Liabilities	2	65	75
Supplier's Credit	19	2,456	255
Trade Payables	20	-	-
(I) Outstanding dues of micro enterprises and small enterprises;		96	52
(II) Outstanding dues of creditors other than micro enterprises and small enterprises		10,919	8,748
Derivatives	49	3,376	1,555
Other Financial Liabilities	21B	1,000	937
Provisions	22	1,006	831
Current Tax Liabilities (Net)	23	1,121	1,168
Contract Liabilities	24	180	136
Other Current Liabilities	25	647	565
		<b>28,277</b>	<b>19,077</b>
		<b>44,629</b>	<b>37,883</b>
		<b>99,057</b>	<b>87,947</b>
Basis of Preparation and Significant Accounting Policies	1		

The accompanying Notes are an integral part of the Standalone Financial Statements

This is the Standalone Balance Sheet referred in our report of even date

**For Price Waterhouse & Co Chartered Accountants LLP**  
Firm Registration Number: 304026E/ E-300009

**Praveen Kumar Maheshwari**  
Whole-time Director &  
Chief Financial Officer  
DIN-00174361

**Satish Pai**  
Managing Director  
DIN-06646758

**Sarah George**  
Partner  
Membership No. 045255

**Anil Malik**  
Company Secretary

**K N Bhandari**  
Director  
DIN No.: 00026078

Place : Mumbai  
Dated : May 26, 2022

# Standalone Statement of Profit and Loss

for the Year ended March 31, 2022

(₹ in Crore)

	Note	Year ended	
		31/03/2022	31/03/2021
<b>INCOME</b>			
Revenue from Operations	26	67,653	42,701
Other Income	27	535	650
<b>Total Income</b>		<b>68,188</b>	<b>43,351</b>
<b>EXPENSES</b>			
Cost of Materials Consumed	28	41,979	27,178
Trade Purchases	29	1,922	1,098
Changes in inventories of Finished Goods, Work-in-Progress and Stock-in-Trade	30	(3,344)	(1,821)
Employee Benefits Expense	31	2,058	1,844
Power and Fuel	32	6,781	5,668
Finance Cost	33	1,417	1,469
Depreciation and Amortization Expense	34	1,752	1,708
Impairment Loss on Non-Current Assets	35	95	140
Impairment Loss/ (Reversal) on Financial Assets (Net)	36	2	(7)
Other Expenses	37	6,962	4,507
<b>Total Expenses</b>		<b>59,624</b>	<b>41,784</b>
Profit/(Loss) before Exceptional Items and Tax		8,564	1,567
Exceptional Income/ (Expenses) (Net)	38	(107)	7
<b>Profit/(Loss) before Tax</b>		<b>8,457</b>	<b>1,574</b>
<b>Tax Expenses</b>	23		
Current Tax Expense		1,496	283
Deferred Tax Expense		1,454	298
<b>Profit/(Loss) for the year</b>		<b>5,507</b>	<b>993</b>
<b>Other Comprehensive Income/ (Loss)</b>	39		
<b>Items that will not be reclassified to Statement of Profit and Loss</b>			
Remeasurement of Defined Benefit Obligation		(5)	57
Change in Fair Value of Equity Instruments Designated as FVTOCI		1,108	4,351
Income Tax effect		(231)	(20)

(₹ in Crore)

	Note	Year ended	
		31/03/2022	31/03/2021
<b>Items that will be reclassified to Statement of Profit and Loss</b>			
Change in Fair Value of Debt Instruments Designated as FVTOCI		(9)	(9)
Effective Portion of Cash flow Hedges		(1,867)	(757)
Cost of Hedging Reserve		(75)	(168)
Income Tax effect		682	326
<b>Other Comprehensive Income/ (Loss) for the year</b>		<b>(397)</b>	<b>3,780</b>
<b>Total Comprehensive Income/ (Loss) for the year</b>		<b>5,110</b>	<b>4,773</b>
<b>Earnings Per Share</b>	40		
Basic (₹)		24.76	4.46
Diluted (₹)		24.73	4.46
<b>Basis of Preparation and Significant Accounting Policies</b>	1		

The accompanying Notes are an integral part of the Standalone Financial Statements

This is the Standalone Statement of Profit and Loss referred in our report of even date

**For Price Waterhouse & Co Chartered Accountants LLP**

Firm Registration Number: 304026E/ E-300009

**Praveen Kumar Maheshwari**

Whole-time Director &  
Chief Financial Officer  
DIN-00174361

**Satish Pai**

Managing Director  
DIN-06646758

**Sarah George**

Partner  
Membership No. 045255

**Anil Malik**

Company Secretary

**K N Bhandari**

Director  
DIN No.: 00026078

Place : Mumbai

Dated : May 26, 2022



# Standalone Statement of Changes in Equity

for the Year ended March 31, 2022

## A Equity Share Capital

(₹ in Crore)		
Particulars	Note	Amount
Balance as at April 01, 2020	16	222
Changes in Equity Share Capital	-	-
Balance as at March 31, 2021	16	222
Changes in Equity Share Capital	-	-
Balance as at March 31, 2022	16	222

## B Other Equity

Particulars	Note	Share Application Money Pending Allotment	Reserves and Surplus							Other Reserves			Total			
			Capital Reserve	Capital Redemption Reserve	Business Reconstruction Reserve	Securities Premium	Debt Redemption Reserve	Employee Stock Options	Treasury Shares held by ESOP Trust	General Reserve	Retained Earnings	Gain/ (Loss) on Equity Instruments		Effective portion of Cash Flow Hedge	Cost of Hedging Reserve	
Balance as at April 01, 2020		-	145	102	7,715	8,227	1,200	45	(130)	21,354	4,834	1766	7	(102)	119	45,272
Profit/ (Loss) for the year		-	-	-	-	-	-	-	-	-	993	-	-	-	993	-
Other Comprehensive Income/ (Loss) for the year		-	-	-	-	-	-	-	-	-	37	4,351	(6)	(493)	(109)	3,780
Total Comprehensive Income/ (Loss) for the year		-	-	-	-	-	-	-	-	-	1,030	4,351	(6)	(493)	(109)	4,773
Hedging (Gain)/ Loss and cost of hedging transferred to non-financial assets		-	-	-	-	-	-	-	-	-	-	-	-	(1)	-	(1)
Transfer to Debenture Redemption Reserve		-	-	-	-	150	-	-	-	(150)	-	-	-	-	-	-
<b>Transactions with owners in their capacity as owners</b>																
Shares issued by the Trust		-	-	-	-	-	-	-	1	-	1	-	-	-	-	2
Employee Share Based Transactions		-	-	-	7	-	-	(4)	-	-	-	-	-	-	-	3
Employee Share Options Expenses		-	-	-	-	-	-	15	-	-	-	-	-	-	-	15
Employee Share Options Lapsed/Forfeited		-	-	-	-	-	-	(1)	-	-	1	-	-	-	-	-
Dividends Paid		-	-	-	-	-	-	-	-	-	(222)	-	-	-	-	(222)
<b>Balance as at March 31, 2021</b>	17	-	145	102	7,715	8,224	1,350	55	(129)	21,354	5,494	6,117	1	(596)	10	49,842

Particulars	Note	Share Application Money Pending Allotment	Reserves and Surplus							Other Reserves			Total			
			Capital Reserve	Capital Redemption Reserve	Business Reconstruction Reserve	Securities Premium	Debt Redemption Reserve	Employee Stock Options	Treasury Shares held by ESOP Trust	General Reserve	Retained Earnings	Gain/ (Loss) on Equity Instruments		Effective portion of Cash Flow Hedge	Cost of Hedging Reserve	
Profit/ (Loss) for the year		-	-	-	-	-	-	-	-	-	-	5,507	(6)	(1,214)	(49)	5,507
Other Comprehensive Income/ (Loss) for the year		-	-	-	-	-	-	-	-	-	(2)	874	(6)	(1,214)	(49)	(397)
Total Comprehensive Income/ (Loss) for the year		-	-	-	-	-	-	-	-	-	5,505	874	(6)	(1,214)	(49)	5,110
Hedging (Gain)/ Loss and cost of hedging transferred to non-financial assets		-	-	-	-	-	-	-	-	-	-	-	-	(41)	-	(41)
Realised Gain/ (Loss) on Equity FVTOCI transferred to Retained Earnings		-	-	-	-	-	-	-	-	-	68	(68)	-	-	-	-
Transfer to Debenture Redemption Reserve		-	-	-	-	150	-	-	-	(150)	-	-	-	-	-	-
<b>Transactions with owners in their capacity as owners</b>																
Shares Acquired by the Trust		-	-	-	-	-	-	-	(94)	-	-	-	-	-	-	(94)
Shares Issued by the Trust		-	-	-	-	-	-	(11)	24	-	2	-	-	-	-	15
Employee Share Based Transactions		-	-	-	9	-	-	(3)	-	-	-	-	-	-	-	6
Employee Share Options Expenses		-	-	-	-	-	-	35	-	-	-	-	-	-	-	35
Dividends Paid		-	-	-	-	-	-	-	-	-	(667)	-	-	-	-	(667)
<b>Balance as at March 31, 2022</b>	17	-	145	102	7,715	8,233	1,500	76	(199)	21,354	10,252	6,923	(5)	(1,851)	(39)	54,206

Basis of Preparation and Significant Accounting Policies 1

The accompanying Notes are an integral part of the Standalone Financial Statements

This is the Standalone Statement of Changes in Equity referred in our report of even date

**For Price Waterhouse & Co Chartered Accountants LLP**

Firm Registration Number: 304026E/ E-300009

**Praveen Kumar Maheshwari**  
Whole-time Director &  
Chief Financial Officer  
DIN-00174361

**Satish Pai**  
Managing Director  
DIN-06646758

**Sarah George**  
Partner  
Membership No. 045255

**Anil Malik**  
Company Secretary

**KN Bhandari**  
Director  
DIN No.: 00026078

Place : Mumbai  
Dated : May 26, 2022

# Standalone Statement of Cash Flows

for the year ended March 31, 2022

	Note	₹ in Crore)	
		Year ended	
		31/03/2022	31/03/2021
<b>A. CASH FLOW FROM OPERATING ACTIVITIES</b>			
Profit/ (Loss) before tax		8,457	1,574
Adjustment for :			
Finance Costs	33	1,417	1,469
Depreciation and Amortization Expense	34	1,752	1,708
Non-Cash Employee Share-Based payments	31	35	15
Impairment Loss/ (Reversal) on Financial Assets (Net)	36	2	(7)
Impairment Loss on Non-Current Assets	35	95	140
Other Non-Operating Income		(117)	(6)
Unrealised Foreign Exchange (Gain)/ Loss (Net)		29	(1)
Unrealised (Gain)/ Loss on Derivative Transactions (Net)		53	434
Fair Value (Gain)/ Loss on modification of Borrowings (Net)		(53)	(56)
(Gain)/ Loss on Assets held for Sale (Net)		-	-
(Gain)/ Loss on Property, Plant and Equipment and Intangible Assets Sold/ Discarded (Net)	27	31	20
Interest Income	27	(144)	(105)
Dividend Income	27	(31)	(18)
Exceptional (Income)/ Expense	38	107	(127)
Changes in Cash Flow Hedges net of reclassification from OCI		(34)	(121)
(Gain)/ Loss on Investments measured at FVTPL (Net)	27	(263)	(421)
Operating profit before Working Capital Changes		<b>11,336</b>	<b>4,498</b>
Changes in Working Capital:			
(Increase)/ Decrease in Inventories (Net)		(4,797)	(3,927)
(Increase)/ Decrease in Trade Receivables		(1,030)	493
(Increase)/ Decrease in Financial Assets		(91)	(35)
(Increase)/ Decrease in Non-Financial Assets		(767)	268
Increase/ (Decrease) in Trade Payables		1,898	4,022
Increase/ (Decrease) in Financial Liabilities		32	(9)
Increase/ (Decrease) in Non-Financial Liabilities (including Contract Liabilities)		179	48
Cash Generated from Operation before Tax		<b>6,760</b>	<b>5,358</b>
Refund/ (Payment) of Income Tax (Net)		(1,552)	206
<b>Net Cash Generated/ (Used) - Operating Activities</b>		<b>5,208</b>	<b>5,564</b>
<b>B. CASH FLOW FROM INVESTING ACTIVITIES</b>			
Payments to acquire Property Plant and Equipment, Intangible Assets and Investment Property		(1,506)	(1,137)
Proceeds from disposal of Property Plant and Equipment, Intangible Assets and Investment Property		67	14
Acquisition of business		(265)	-
Investment in Subsidiaries		(26)	(1)
Return of Capital from Subsidiary		557	-
Investment in Associates and Joint Ventures		(1)	-
Investment in Equity Shares at FVTOCI		102	(43)
(Purchase)/ Sale of Other Investments (Net)		2,966	(2,278)
Loans and Deposits given		(4,029)	(167)
Receipt of Loans and Deposits given		44	8
Interest Received		123	100
Dividend Received		31	18
<b>Net Cash Generated/ (Used) - Investing Activities</b>		<b>(1,937)</b>	<b>(3,486)</b>

	Note	₹ in Crore)	
		Year ended	
		31/03/2022	31/03/2021
<b>C. CASH FLOW FROM FINANCING ACTIVITIES</b>			
Proceeds from issue of Equity Shares (Including Share Application Money)		6	3
Treasury Shares acquired by ESOP Trust		(94)	-
Proceeds from Shares issued by ESOP Trust		15	2
Proceeds from Long-Term Borrowings	18A	2,500	-
Pre-payment of Long-Term Borrowings	18A	(460)	-
Repayment of Long-Term Borrowings	18A	(8)	(6)
Principal Payments of Leases Liabilities	18A	(71)	(69)
Proceeds from/ (Repayment of) Current Borrowings (Net)	18A	(2,923)	(2,829)
Proceeds from Current Borrowings from Subsidiary		1,000	-
Repayment of Current Borrowings from Subsidiary		(1,000)	-
Increase/ (Decrease) in Supplier's Credit	18A	2,161	255
Finance Cost Paid		(1,328)	(1,440)
Dividend Paid		(667)	(222)
<b>Net Cash Generated/ (Used) - Financing Activities</b>		<b>(869)</b>	<b>(4,306)</b>
<b>Net Increase/(Decrease) in Cash and Cash Equivalents</b>		<b>2,402</b>	<b>(2,228)</b>
Add: Opening Cash and Cash Equivalents		1,003	3,231
Closing Cash and Cash Equivalents		<b>3,405</b>	<b>1,003</b>
<b>Reconciliation of Closing Cash and Cash Equivalents with Balance Sheet:</b>			
Cash and Cash Equivalents as per Balance Sheet	13	3,405	1,003
Less: Temporary Overdraft Balance in Current Accounts	21B	-	-
Cash and Cash Equivalents as per Cash Flow Statement		<b>3,405</b>	<b>1,003</b>
<b>Supplemental Information</b>			
Non Cash Transactions from Investing and Financing Activities:			
Acquisition of Right of Use Assets	2B	131	17
<b>Basis of Preparation and Significant Accounting Policies</b>	1		

The accompanying Notes are an integral part of the Standalone Financial Statements

This is the Standalone Statement of Cash Flows referred in our report of even date

For Price Waterhouse & Co Chartered Accountants LLP

Firm Registration Number: 304026E/ E-300009

Praveen Kumar Maheshwari

Whole-time Director &  
Chief Financial Officer  
DIN-00174361

Satish Pai

Managing Director  
DIN-06646758

Sarah George

Partner  
Membership No. 045255

Anil Malik

Company Secretary

K N Bhandari

Director  
DIN No.: 00026078

Place : Mumbai

Dated : May 26, 2022

# Notes

## forming part of the Standalone Financial Statements

### Company Overview

Hindalco Industries Limited ("the Company") was incorporated in India in the year 1958 having its registered office at Ahura Centre, 1st Floor, B Wing, Mahakali Caves Road, Andheri (East), Mumbai - 400093.

The Company has two main streams of business Aluminium and Copper. In Aluminium, the Company caters to the entire value chain starting from mining of bauxite and coal through production of value added products for various applications.

The Company along with its subsidiaries has manufacturing operations in ten countries including India spread over four continents North America, South America, Asia and Europe. Apart from primary aluminium, the Company produces aluminium sheet, extrusion and light gauge products for use in packaging market which includes beverage and food, can and foil products as well as for use in automotive, electronic, architecture, transportation and industrial product markets.

The Company also has one of the largest single location Copper smelting facility in India.

The equity shares of the Company are listed on National Stock Exchange of India Limited (NSE) and BSE Limited (BSE). GDRs are listed on the Luxembourg Stock Exchange.

### 1. Basis of Preparation and Significant Accounting Policies

#### 1A. Basis of preparation

The separate financial statements of Hindalco Industries Limited ("the Company") comply in all material aspects with Indian Accounting Standards ("Ind-AS") as prescribed under section 133 of the Companies Act, 2013 ("the Act"), as notified under the Companies (Indian Accounting Standards) Rules, 2015 (including subsequent amendments) and other accounting principles generally accepted in India.

The financial statements for the year ended March 31, 2022 have been approved for issue by the Board of Directors of the Company in their meeting held on May 26, 2022.

The financial statements have been prepared on historical cost convention on accrual basis except for following assets and liabilities which have been measured at fair value:

- Certain financial instruments - measured at fair value;
- Assets held for sale - measured at fair value less cost to sell;
- Plan assets under defined benefit plans - measured at fair value;
- Liabilities for Cash settled share-based payments; and
- Inventories those are designated in a Fair value hedge relationship where both the derivative and inventory are fair valued.

In addition, the carrying values of recognised assets and liabilities designated as hedged items in fair value hedges that would otherwise be carried at cost are adjusted to record changes in the fair values attributable to the risks that are being hedged in effective hedge relationship.

Historical cost is generally based on the fair value of the consideration given in exchange for goods and services.

Fair value is the price that would be received to sell an asset or paid to transfer a liability in an orderly transaction between market participants at the measurement date, regardless of whether that price is directly observable or estimated using another valuation technique. In estimating the fair value of an asset or a liability, the Company take into account the characteristics of the asset or liability if market participants would take those characteristics into account when pricing the asset or liability at the measurement date. Fair value for measurement and/or disclosure purposes in these financial statements is determined on such a basis, except for employee share-based payment, leasing transactions, and measurements that have some similarities to fair value but are not fair value, such as net realisable value in Inventories or value in use in Impairment of Assets. The basis of fair valuation of these items are given as part of their respective accounting policies.

Company has determined current and non-current classification of its assets and liabilities in the financial statements as per the requirement of Ind AS 1- 'Presentation of Financial Statements'. Based on its assessment, the Company has ascertained its normal operating cycle as 12 months for the purpose of current and non-current classification of its assets and liabilities.

In addition, for financial reporting purposes, fair value measurements are categorised into Level 1, 2 or 3 based on the degree to which the inputs to the fair value measurements are observable and the significance of the inputs to the fair value measurement in its entirety, which are described as follows:

- Level 1 inputs are quoted prices (unadjusted) in active markets for identical assets or liabilities that the Company can access at the measurement date;
- Level 2 inputs are inputs, other than quoted prices included within Level 1, that are observable for the asset or liability, either directly or indirectly; and
- Level 3 inputs are unobservable inputs for the asset or liability.

The Financial Statements have been presented in Indian Rupees (INR), which is the Company's functional currency. All financial information presented in INR has been rounded off to the nearest Crore Rupees (INR 1 Crore = INR 10,000,000) without any decimal unless otherwise stated.

#### 1B. Significant Accounting Policies

A summary of the significant accounting policies applied in the preparation of the financial statements are as given below. These accounting policies have been applied consistently to all the periods presented in the financial statements.

##### A. Investment in Subsidiaries and joint ventures

The investments in subsidiaries and joint ventures are carried in the financial statements at historical cost except when the investment, or a portion thereof, is classified as held for sale, in which case measured at lower of carrying amount and fair value less costs to sell. When the Company is committed to a sale plan involving disposal of an investment, or a portion of an investment, in any subsidiary or joint venture, the investment or the portion of the investment that will be disposed of is classified as held for sale when the criteria described above are met. Any retained portion of an investment in a subsidiary or a joint venture that has not been classified as held for sale continues to be accounted for at historical cost.

Investments in subsidiaries and joint ventures carried at cost are tested for impairment in accordance with Ind AS 36 Impairment of Assets. The carrying amount of the investment is tested for impairment as a single asset

by comparing its recoverable amount with its carrying amount, any impairment loss recognised reduces the carrying amount of the investment.

##### B. Investment in Associates

The investments in associates are carried in these financial statements at fair Value through Other Comprehensive Income (OCI).

##### C. Investment in joint operations

A joint operation is a joint arrangement whereby the parties that have joint control of the arrangement have rights to the assets, and obligations for the liabilities, relating to the arrangement. Joint control is the contractually agreed sharing of control of an arrangement, which exists only when decisions about the relevant activities require unanimous consent of the parties sharing control.

When the Company undertakes its activities under joint operations, the Company as a joint operator recognises in relation to its interest in a joint operation:

- its assets, including its share of any assets held jointly;
- its liabilities, including its share of any liabilities incurred jointly;
- its revenue from the sale of its share of the output arising from the joint operation;
- its share of the revenue from the sale of the output by the joint operation; and
- its expenses, including its share of any expenses incurred jointly

The Company accounts for the assets, liabilities, revenues and expenses relating to its interest in a joint operation in accordance with the standard applicable to the particular assets, liabilities, revenues and expenses.

When the Company transacts with a joint operation in which the Company is a joint operator (such as a sale or contribution of assets), the Company is considered to be conducting the transaction with the other parties to the joint operation, and gains and losses resulting from the transactions are recognised in the financial statements only to the extent of other parties' interests in the joint operation.



# Notes

forming part of the Standalone Financial Statements

When the Company transacts with a joint operation in which the Company is a joint operator (such as a purchase of assets), the Company does not recognise its share of the gains and losses until it resells those assets to a third party.

See Note 5 - Investment in Subsidiaries and Note 6 - Investment in Associates and Joint Ventures for further details.

## D. Property, Plant and Equipment

Property, plant and equipment held for use in the production or/and supply of goods or services, or for administrative purposes, are stated in the balance sheet at cost, less any subsequent accumulated depreciation and subsequent accumulated impairment losses.

The initial cost at cash price equivalent of property, plant and equipment acquired comprises its purchase price, including import duties and non-refundable purchase taxes, any directly attributable costs of bringing the assets to its working condition and location and present value of any obligatory decommissioning costs for its intended use. Cost may also include effective portion on qualifying cash flow hedges of foreign currency purchases of property, plant and equipment transferred from hedge reserve as basis adjustment.

In case of self-constructed assets, cost includes the costs of all materials used in construction, direct labour, allocation of overheads, directly attributable borrowing costs and effective portion of cash flow hedges of foreign currency transferred from the hedge reserve as basis adjustment.

Subsequent expenditure on major maintenance or repairs includes the cost of the replacement of parts of assets and overhaul costs. Where an asset or part of an asset is replaced and it is probable that future economic benefits associated with the item will be available to the Company, the expenditure is capitalised and the carrying amount of the item replaced is derecognised.

Similarly, overhaul costs associated with major maintenance which can be measured reliably are capitalised and depreciated over their useful lives where it is probable that future economic benefits will be available and any remaining carrying amounts of the cost of previous overhauls are derecognised. All other costs are charged to profit and loss during the reporting period in which they are incurred.

## Capital work-in-progress

Capital work-in-progress comprises of tangible items in the course of construction for production or/and supply of goods or services or administrative purposes are carried at cost, less any accumulated impairment loss. At the point when an asset is capable of operating at management's intended use, the cost of construction is transferred to the appropriate category of property, plant and equipment. Costs associated with the commissioning of an asset are capitalised.

## Depreciation

Depreciation is charged so as to write off the cost or value of assets, over their estimated useful lives. Depreciation is recorded using the straight line basis. The estimated useful lives and residual values are reviewed at each year end, with the effect of any changes in estimate accounted for on a prospective basis. Each component of an item of property, plant and equipment with a cost that is significant in relation to the total cost of that item is depreciated separately if its useful life differs from the others components of the asset.

Depreciation commences when the assets are ready for their intended use. Depreciated assets in Property, Plant & Equipment and accumulated depreciation amounts are retained fully until they are removed/retired from active use.

Leasehold improvements are depreciated over the shorter of their useful life or the lease term, unless the entity expects to use the assets beyond the lease term.

The useful life of the items of Property, Plant and Equipment estimated by the management for the current and comparative period are in line with the useful life as per Schedule II of the Companies Act, 2013, refer note 2.

## Disposal of assets

An item of property, plant and equipment is derecognised upon disposal or when no future economic benefits are expected to arise from the continued use of the asset. Any gain or loss arising on the disposal or retirement of an item of property, plant and equipment is determined as the difference between net disposal proceeds and the carrying amount of the asset and is recognised in the statement of profit and loss.

See Note 2 - Property, Plant and Equipment (including ROU Assets) and Capital Work-in-Progress for further details.

## E. Investment properties

Investment properties held to earn rentals or for capital appreciation or both are stated in the balance sheet at cost, less any subsequent accumulated depreciation and subsequent accumulated impairment losses. Depreciation is charged on a straight line basis over their estimated useful lives. Any gain or loss on disposal of investment property is determined as the difference between net disposal proceeds and the carrying amount of the property and is recognized in the statement of profit and loss. Transfer to, or from, investment property is done at the carrying amount of the property. See Note 3 - Investment Properties for further details.

## F. Intangible Assets

### Goodwill

Goodwill arising on acquisition is carried at cost as established at the date of acquisition of the business less accumulated impairment losses, if any. For the purpose of impairment testing, goodwill is allocated to each of the cash-generating units expected to benefit from the synergies of the combination.

Cash-generating units to which goodwill has been allocated are tested for impairment annually, or more frequently when there is an indication that the unit may be impaired. If the recoverable amount of the cash generating unit is less than the carrying amount of the unit, the impairment loss is allocated first to reduce the carrying amount of any goodwill allocated to the unit and then to the other assets of the unit pro-rata on the basis of the carrying amount of each asset in the unit. An impairment loss recognised for goodwill is not reversed in a subsequent period.

### Intangible assets acquired separately

Intangible assets acquired are reported at cost less accumulated amortization and accumulated impairment losses. Amortization is charged on a straight line basis over their estimated useful lives other than Mining rights. The estimated useful life and amortization method are reviewed at the end of each annual reporting period, with the effect of any changes in estimate being accounted for on a prospective basis.

### Internally-generated intangible assets

Expenditure on research activities is recognized as an expense in the period in which it is incurred.

An internally-generated intangible asset arising from

development (or from the development phase of an internal project) is recognized if, and only if all of the following can be demonstrated:

- the technical feasibility of completing the intangible asset so that it will be available for use or sale;
- management's intention to complete the intangible asset and use or sell it;
- the ability to use or sell the intangible asset;
- how the intangible asset will generate probable future economic benefits;
- the availability of adequate technical, financial and other resources to complete the development and to use or sell the intangible asset; and
- the ability to measure reliably the expenditure attributable to the intangible asset during its development.

The amount initially recognized for internally-generated intangible assets is the sum of the expenditure incurred from the date when the intangible asset is recognised. Where no internally-generated intangible asset can be recognized, development expenditure is charged to the statement of profit and loss in the period in which it is incurred.

Subsequent to initial recognition, internally-generated intangible assets are reported at cost less accumulated amortization and accumulated impairment losses, on the same basis as intangible assets acquired separately.

## Mineral Reserves, Resources and Rights (Mining Rights)

Mineral reserves, resources and rights (together referred to as 'mining rights') which can be reasonably valued, are recognised in the assessment of fair values on acquisition. Exploitable mineral rights are amortised using the unit of production basis over the commercially recoverable reserves. Mineral resources are included in amortisation calculations where there is a high degree of confidence that they will be extracted in an economic manner. Commercially recoverable reserves are proved and probable reserves. Changes in the commercial recoverable reserves affecting unit of production calculations are dealt with prospectively over the revised remaining reserves.

# Notes

forming part of the Standalone Financial Statements

## Exploration for and evaluation of mineral resources

Expenditures associated with exploration for and evaluation of mineral resources after obtaining of legal rights to explore a specific area but before technical feasibility and commercial viability of extracting mineral resources are demonstrable are recognized as Exploration and Evaluation assets.

If a project does not prove viable, all irrecoverable exploration and evaluation expenditure associated with the project net of any related impairment allowances is written off to the statement of profit and loss.

The Company measure its Exploration and Evaluation assets at cost and classifies it as Property, Plant and Equipment or Intangible Assets according to the nature of assets acquired and applies the classification consistently.

As the assets is not available for use, it is not depreciated but are monitored for indication of impairment. An exploration and evaluation asset is no longer classified as such when the technical feasibility and commercial viability of extracting minerals resources are demonstrable and the development of the deposit is intended by the management. The carrying value of such exploration and evaluation asset is reclassified as Mining Rights.

## De-recognition of intangible assets

An intangible asset is derecognised on disposal, or when no future economic benefits are expected from use or disposal. Gains or losses arising from derecognition of an intangible asset, measured as the difference between the net disposal proceeds and the carrying amount of the asset are recognised in the statement of profit and loss when the asset is derecognised.

Intangible assets with indefinite useful lives and intangible assets not yet available for use are tested for impairment annually, and whenever there is an indication that the asset may be impaired.

See Note 4A - Goodwill for further details

See Note 4B - Intangible Assets and Intangible Assets under Development for further details.

## G. Stripping cost

Stripping costs incurred during the mining production phase are allocated between cost of inventory produced and the existing mine asset. The stripping ratio, as

approved by the regulatory authority, for the life of the mine is obtained by dividing the estimated quantity of overburden by the estimated quantity of mineable coal / bauxite reserve to be extracted over the life of the mine. This ratio is periodically reviewed and changes, if any, are accounted for prospectively.

Stripping costs are allocated and included as a component of the mine asset when they represent significantly improved access to ore, provided all the following conditions are met:

- it is probable that the future economic benefit associated with the stripping activity will be realised;
- the component of the ore body for which access has been improved can be identified; and
- the costs relating to the stripping activity associated with the improved access can be reliably measured.

The overburden removal costs are included in Mining Rights under Intangible assets and amortised based on stripping ratio on the quantity of coal / bauxite excavated.

See Note 4B - Intangible Assets and Intangible Assets under Development for further details.

## H. Non-current assets (or disposal group) held for sale

Non-current assets and disposal group are classified as held for sale if their carrying amount will be recovered principally through a sale transaction rather than through continuing use. This condition is regarded as met only when the asset (or disposal Group) is available for immediate sale in its present condition subject only to terms that are usual and customary for sales of such asset (or disposal Group) and its sale is highly probable. Management must be committed to the sale, which should be expected to qualify for recognition as a completed sale within one year from the date of classification.

Non-current assets (and disposal group) classified as held for sale are measured at the lower of their carrying amount and fair value less costs to sell except for those assets that are specifically exempt under relevant Ind AS. Once the assets are classified as "Held for sale", those are not subjected to depreciation till disposal.

An impairment loss is recognised for any initial or subsequent write-down of the asset (or disposal group) to fair value less costs to sell. A gain is recognised for any subsequent increases in fair value less costs to sell

of an asset (or disposal group), but not in excess of any cumulative impairment loss previously recognised.

A gain or loss not previously recognised by the date of the sale of the non-current asset (or disposal group) is recognised at the date of derecognition.

Non-current assets classified as held for sale and the assets of a disposal group classified as held for sale are presented separately from the other assets in the balance sheet.

## Discontinued Operations

A discontinued operation is a component of the entity that has been disposed off or is classified as held for sale and that represents a separate major line of business or geographical area of operations, is part of a single co-ordinated plan to dispose of such a line of business or area of operations, or is a subsidiary acquired exclusively with a view to resale. The results of discontinued operations are presented separately in the statement of profit and loss.

See Note 15 - Non-Current Assets Held For Sale for further details.

## I. Impairment of Non-Current Assets

At the end of each reporting period, the Company reviews the carrying amounts of its tangible, intangible and other non-current assets to determine whether there is any indication that those assets have suffered an impairment loss. If any such indication exists, the recoverable amount of the asset/cash generating unit is estimated in order to determine the extent of the impairment loss (if any). Recoverable amount is the higher of fair value less cost to sell and Value in use. Where it is not possible to estimate the recoverable amount of an individual asset, the Company estimates the recoverable amount of the cash-generating unit to which the asset belongs. Where a reasonable and consistent basis of allocation can be identified, corporate assets are also allocated to individual cash-generating units, or otherwise they are allocated to the group of cash-generating units for which a reasonable and consistent allocation basis can be identified.

Recoverable amount is the higher of fair value less costs to sell and value in use. In assessing value in use, the estimated future cash flows are discounted to their present value using a pre-tax discount rate that reflects current market assessments of the time value of money and the risks specific to the asset for which the estimates of future cash flows have not been adjusted.

If the recoverable amount of an asset (or cash-generating unit) is estimated to be less than its carrying amount, the carrying amount of the asset (or cash-generating unit) is reduced to its recoverable amount. An impairment loss is recognised immediately in the statement of profit and loss.

Non-current assets (other than Goodwill) that suffered an impairment are reviewed for possible reversal of the impairment at the end of each reporting period. Where an impairment loss subsequently reverses, the carrying amount of the asset (or cash-generating unit) is increased to the revised estimate of its recoverable amount, but so that the increased carrying amount does not exceed the carrying amount that would have been determined had no impairment loss been recognised for the asset (or cash-generating unit) in prior years. A reversal of an impairment loss is recognised immediately in the statement of profit and loss.

See Note 2 - Property, Plant and Equipment (including ROU Assets) and Capital Work-in-Progress for further details.

See Note 3 - Investment Properties for further details.

See Note 4B - Intangible Assets and Intangible Assets under Development for further details.

See Note 35 - Impairment Loss on Non-Current Assets for further details.

## J. Foreign currency Transactions

In preparing the financial statements, transactions in currencies other than the Company's functional currency (foreign currencies) are recognised at the rates of exchange prevailing at the dates of the transactions. At the end of each reporting period, monetary items denominated in foreign currencies are translated at the rates prevailing at that date. Non-monetary items are measured at historical cost.

Exchange differences on monetary items are recognised in the statement of profit and loss in the period in which they arise, except for:

- eligible exchange differences on foreign currency borrowings relating to qualifying assets under construction are included in the cost of those assets when they are regarded as an adjustment to interest; and



# Notes

forming part of the Standalone Financial Statements

- exchange differences on transactions entered into in order to hedge certain foreign currency risks (see below for hedge accounting policies).

Changes in the fair value of non-monetary equity instruments irrevocably classified as fair value through other comprehensive income includes gain or loss on account of exchange differences.

The fair value of financial liabilities and financial assets denominated in a foreign currency are translated at the spot rate at the end of the reporting period. The foreign exchange component forms part of its fair value gain or loss. Non-monetary items that are measured at fair value in a foreign currency are translated using the exchange rates at the date when the fair value was measured.

See Note 33 – Finance Cost for further details.

See Note 37 – Other Expenses for further details.

## K. Provisions and contingencies

Provisions are recognized when there is a present obligation (legal or constructive) as a result of a past event and it is probable (“more likely than not”) that it is required to settle the obligation, and a reliable estimate can be made of the amount of the obligation.

The amount recognised as a provision is the best estimate of the consideration required to settle the present obligation at the balance sheet date, taking into account the risks and uncertainties surrounding the obligation. Where a provision is measured using the estimated cash flows to settle the present obligation, its carrying amount is the present value of those cash flows. The discount rate used is a pre-tax rate that reflects current market assessments of the time value of money in that jurisdiction and the risks specific to the liability.

### Onerous contracts

Present obligations arising under onerous contracts are recognised and measured as provisions. An onerous contract is considered to exist when a contract under which the unavoidable costs of meeting the obligations exceed the economic benefits expected to be received from it.

### Restructurings

A restructuring provision is recognised when there is a

detailed formal plan for the restructuring which has raised a valid expectation in those affected that the Company will carry out the restructuring by stating to implement the plan or announcing its main feature to those affected by it. The measurement of a restructuring provision includes only the direct expenditures arising from the restructuring which are both necessarily entailed by the restructuring and not associated with the ongoing activities of the Company.

### Restoration (including Mine closure), rehabilitation and decommissioning

Close-down and restoration costs are provided for in the accounting period when the obligation arising from the related disturbance occurs, based on the net present value of the estimated future costs of restoration to be incurred during the life of the mining operation and post closure. Provisions for close-down and restoration costs do not include any additional obligations which are expected to arise from future disturbance.

The initial close-down and restoration provision is capitalised. Subsequent movements in the close-down and restoration provisions for ongoing operations, including those resulting from new disturbance related to expansions or other activities qualifying for capitalisation, updated cost estimates, changes to the estimated lives of operations, changes to the timing of closure activities and revisions to discount rates are also capitalised within “Property, plant and equipment”.

### Environmental liabilities

Environment liabilities are recognised when the Company becomes obliged, legally or constructively, to rectify environmental damage or perform remediation work.

### Litigation

Provision relating to legal, tax and other matters is recognised once it has been established that the Company has a present obligation based on consideration of the information which becomes available up to the date on which the Company’s financial statements are approved and may in some cases entail seeking expert advice in making the determination on whether there is a present obligation.

### Contingent Liabilities and Assets

A contingent liability is a possible obligation that arises from a past event, with the resolution of the contingency dependent on uncertain future events, or a present obligation where no outflow is probable.

Material contingent liabilities are disclosed in the financial statements unless the possibility of an outflow of economic resources is remote. Contingent assets are not recognized in the financial statements unless it is virtually certain that the future event will confirm the asset’s existence and the asset will be realised.

### Enterprise Social Commitment

Enterprise Social Commitment is the amount to be spent on social and economic development of the surrounding area over a period of time where any new project is set up. Such obligation arises out of conditions mentioned in the Environment Clearance Certificate given by the Government for new projects and are generally defined as a percentage of total project cost. Present value of such future cash flows discounted at appropriate and applicable discount rates are capitalised against the obligation created. Actual cash flows that happen over the period are adjusted against the obligation. The obligation is increased over a period of time and the differential is recognized in the Statement of Profit and Loss as Interest Expense.

### Renewable Power Obligation

Provision towards Renewable Power obligation is created to the extent any obligated unit is unable to source renewable energy as a replacement to carbon energy as per requirement of the applicable regulation during the reporting period and is carried in books till the obligation is discharged by purchasing Renewable Energy Certificate from any of the authorised exchanges.

See Note 22 – Provisions for further details.

See Note 44 – Contingent Liabilities and Commitments for further details.

## L. Leases

### Company as lessee

The Company assesses whether a contract is or contains a lease, at inception of the contract. The Company recognises a right-of-use asset and a corresponding lease liability with respect to all lease arrangements in which it is the lessee, except for short-term leases (defined as leases with a lease term of 12 months or less) and leases of low value assets. For these leases, the Company recognises the lease payments as an operating expense on a straight-line basis over the lease term, unless another systematic basis is more representative of the time pattern in which economic benefits from the leased assets are consumed.

Contingent and variable rentals are recognized as expense in the periods in which they are incurred.

### Lease Liability

The lease payments that are not paid at the commencement date are discounted using the interest rate implicit in the lease. If that rate cannot be readily determined, which is generally the case for leases in the Company, the lessee’s incremental borrowing rate is used, being the rate that the individual lessee would have to pay to borrow the funds necessary to obtain an asset of similar value to the right-of-use asset in a similar economic environment with similar terms, security and conditions.

To determine the incremental borrowing rate, the Company uses a build-up approach that starts with a risk-free interest rate adjusted for credit risk and makes adjustments specific to the lease, e.g. term, security etc.

Lease payments included in the measurement of the lease liability comprise:

- Fixed lease payments (including in-substance fixed payments) payable during the lease term and under reasonably certain extension options, less any lease incentives;
- Variable lease payments that depend on an index or rate, initially measured using the index or rate at the commencement date;
- The amount expected to be payable by the lessee under residual value guarantees;
- The exercise price of purchase options, if the lessee is reasonably certain to exercise the options; and
- Payments of penalties for terminating the lease, if the lease term reflects the exercise of an option to terminate the lease.

The lease liability is presented as a separate line in the Standalone Balance Sheet.

The lease liability is subsequently measured by increasing the carrying amount to reflect interest on the lease liability (using the effective interest method) and by reducing the carrying amount to reflect the lease payments made.

The Company remeasures the lease liability (and makes a corresponding adjustment to the related right-of-use asset) to reflect any re-assessment, lease modification, or revised in-substance fixed lease payments.



# Notes

forming part of the Standalone Financial Statements

## Right of Use (ROU) Assets

The ROU assets comprise the initial measurement of the corresponding lease liability, lease payments made at or before the commencement day and any initial direct costs. They are subsequently measured at cost less accumulated depreciation and impairment losses.

Whenever the Company incurs an obligation for costs to dismantle and remove a leased asset, restore the site on which it is located or restore the underlying asset to the condition required by the terms and conditions of the lease, a provision is recognised and measured under Ind AS 37 Provisions, Contingent Liabilities and Contingent Assets. The costs are included in the related right-of-use asset.

For the certain class of assets, the Company allocates lease or non-lease components on the basis of their relative stand-alone prices while assessing a contract at its inception or on reassessment.

The Company applies Ind AS 36- Impairment of Assets to determine whether a right-of-use asset is impaired and accounts for any identified impairment loss as per its accounting policy on 'property, plant and equipment'.

Extension and termination options are included in many of the leases. In determining the lease term the management considers all facts and circumstances that create an economic incentive to exercise an extension option, or not exercise a termination option.

ROU assets are depreciated over the shorter period of the lease term and useful life of the underlying asset. If the Company is reasonably certain to exercise a purchase option, the right-of-use asset is depreciated over the underlying asset's useful life. The depreciation starts at the commencement date of the lease.

Deferred tax on the deductible temporary difference and taxable temporary differences in respect of carrying value of right of use assets and lease liability and their respective tax bases are recognised separately.

## The Company as Lessor

The Company enters into lease arrangements as a lessor with respect to some of its investment properties and buildings.

Leases for which the Company is a lessor are classified as finance or operating leases. Whenever the terms of

the lease transfer substantially all the risks and rewards of ownership to the lessee, the contract is classified as finance lease. All other leases are classified as operating leases.

When the Company is an intermediate lessor, it accounts for the head lease and sublease as two separate contracts. The sublease is classified as finance or operating lease by reference to the right-of-use asset arising from the head lease.

Rental income from operating leases is recognised on a straight-line basis over the term of the relevant lease. Initial direct costs incurred in negotiating and arranging an operating lease are added to the carrying amount of the leased asset and recognised on a straight-line basis over the lease term.

Amounts due from lessees under finance leases are recognised as receivables at the amount of the Company's net investment in the leases. Finance lease income is allocated to accounting periods so as to reflect a constant periodic rate of return on the Company's net investment outstanding in respect of the leases.

When a contract includes lease and non-lease components, the Company applies Ind AS 115, Revenue from Contracts with Customers to allocate the consideration under the contract to each component.

See Note 2B – Right of Use Assets for further details.

See Note 2C – Lease liabilities recognised against Right of Use assets for further details.

See Note 37 – Other Expenses for further details.

## M. Inventories

Inventories are stated at the lower of cost and net realizable value. The cost of finished goods and work in progress includes raw materials, direct labour, other direct costs and related production overheads. Costs of inventories include the transfer from equity any gains/losses on qualifying cash flow hedges for purchases of raw materials.

Cost of raw material and Traded Goods comprises of Cost of purchases and also include all other costs incurred in bringing the inventories to their present location and condition and are net of rebates and discounts.

The Inventories are measured at Fair Value only in those cases where the Inventories are designated into a fair value hedge relationship.

Cost is determined using the weighted average cost basis. However, the same cost basis is applied to all inventories of a particular class. Inventories of stores and spare parts are valued at weighted average cost basis after providing for cost of obsolescence and other anticipated losses, wherever considered necessary.

Net realizable value represents the estimated selling price for inventories less all estimated costs of completion and costs necessary to make the sale.

Materials and other supplies held for use in the production of inventories (finished goods, work-in-progress) are not written down below the cost if the finished products in which they will be used are expected to sell at or above the cost.

See Note 11 – Inventories for further details.

## N. Trade receivables

Trade receivables are amounts due from customers for goods sold or services performed in the ordinary course of business. If the receivable is expected to be collected within a period of 12 months or less from the reporting date (or in the normal operating cycle of the business, if longer), they are classified as Current Assets otherwise as Non-Current Assets.

Trade receivables are measured at their transaction price on initial recognition, unless it contains a significant financing component or pricing adjustments embedded in the contract in which cases, it is recognised at fair value. Trade receivables are held with the objective of collecting the contractual cash flows and therefore are subsequently measured at amortised cost less loss allowance.

Trade receivables which are subject to a factoring arrangement without recourse are de-recognized from the Balance Sheet in its entirety. Under this arrangement, the Company transfers relevant receivables to the factor in exchange for cash and does not retain late payment and credit risk.

Trade receivables which arise from contracts where the sale price is provisional and revenue model have the character of a commodity derivative are measured at

fair value. The fair value is measured at forward rate and subsequent changes are recognised as Other Operating Revenue.

See Note 12 – Trade Receivables for further details

## O. Trade and other payables

These amounts represent liabilities for goods and services provided to the Company and are unpaid at the end of the financial year. The amounts are unsecured and usually paid within time limits as contracted. Trade and other payables are presented as current liabilities unless the payment is not due within 12 months after the reporting period.

They are recognised initially at their transactional value which represents the fair value and subsequently measured at amortised cost using the effective interest method wherever applicable.

See Note 20 – Trade Payables for further details.

## P. Financial Instruments

All financial assets are recognised on trade date when the purchase of a financial asset is under a contract whose term requires delivery of the financial asset within the timeframe established by the market concerned. Financial assets are initially measured at fair value, plus transaction costs, except for those financial assets which are classified as at fair value through profit or loss (FVTPL) at inception. All recognised financial assets are subsequently measured in their entirety at either amortised cost or fair value.

### Classification of financial assets

Financial assets are classified as 'equity instrument' if it is a non-derivative and meets the definition of 'equity' for the issuer. All other non-derivative financial assets are 'debt instruments'.

### Financial assets at amortised cost and the effective interest method

Debt instruments are measured at amortised cost if both of the following conditions are met:

- the asset is held within a business model whose objective is to hold assets in order to collect contractual cash flows; and
- the contractual terms of the instrument give rise on specified dates to cash flows that are solely payments of principal and interest on the principal amount outstanding.

# Notes

forming part of the Standalone Financial Statements

Debt instruments meeting these criteria are subsequently measured at amortised cost using the effective interest method less any impairment, with interest recognised on an effective yield basis in investment income.

The effective interest method is a method of calculating the amortised cost of a debt instrument and of allocating interest over the relevant period. The effective interest rate is the rate that exactly discounts the estimated future cash receipts (including all fees or and points paid or received that form an integral part of the effective interest rate, transaction costs and other premiums or discounts) through the expected life of the debt instrument, or (where appropriate) a shorter period, to the net carrying amount on initial recognition.

The Company may irrevocably elect at initial recognition to classify a debt instrument that meets the amortised cost criteria above as at FVTPL if that designation eliminates or significantly reduces an accounting mismatch had the financial asset been measured at amortised cost.

## Financial assets at fair value through other comprehensive income (FVTOCI)

Debt instruments are measured at FVTOCI if both of the following conditions are met:

- the asset is held within a business model whose objective is to hold assets in order to collect contractual cash flows and selling assets; and
- the contractual terms of the instrument give rise on specified dates to cash flows that are solely payments of principal and interest on the principal amount outstanding

Debt instruments meeting these criteria are subsequently measured at fair value with any gains or losses arising on re-measurement recognised in other comprehensive income, except for impairment gains or losses, interest income and foreign exchange gains or losses which are recognised in profit and loss. Interest calculated using the effective interest method is recognised in the statement of profit and loss in investment income. When the debt instrument is derecognised the cumulative gain or loss previously recognised in other comprehensive income is reclassified to the statement of profit and loss account as a reclassification adjustment.

At initial recognition, an irrevocable election is made (on an instrument-by-instrument basis) to designate investments in equity instruments (other than held for trading purpose) at FVTOCI.

A financial asset is held for trading if:

- it has been acquired principally for the purpose of selling it in the near term; or
- on initial recognition it is part of a portfolio of identified financial instruments that the Company manages together and has evidence of a recent actual pattern of short-term profit-taking; or
- it is a derivative that is not designated in an effective hedge relationship as a hedging instrument or not a financial guarantee.

Investments in equity instruments at FVTOCI are subsequently measured at fair value with gains and losses arising from changes in fair value recognised in other comprehensive income and accumulated in the 'Gain/ (Loss) on Equity Instruments FVTOCI'. Where the asset is disposed of, the cumulative gain or loss previously accumulated in the 'Gain/ (Loss) on Equity Instruments FVTOCI' is directly reclassified to retained earnings.

For equity instruments measured at fair value through other comprehensive income, no impairments are recognised in the statement of profit and loss.

Dividends on these investments in equity instruments are recognised in the statement of profit and loss in investment income when the Company's right to receive the dividends is established, it is probable that the economic benefits associated with the dividend will flow to the entity; and the amount of the dividend can be measured reliably.

## Financial assets at Fair Value through Profit and Loss (FVTPL)

Financial assets that do not meet the criteria of classifying as amortised cost or fair value through other comprehensive income described above, or that meet the criteria but the entity has chosen to designate as at FVTPL at initial recognition, are measured at FVTPL.

Investments in equity instruments are classified

as at FVTPL, unless the Company designates an investment that is not held for trading at FVTOCI at initial recognition.

Financial assets at FVTPL are subsequently measured at fair value, with any gains or losses arising on re-measurement recognised in statement of profit and loss. Interest income from these financial assets is included in other income.

Dividend income on investments in equity instruments at FVTPL is recognised in the statement of profit and loss in investment income when the Company's right to receive the dividends is established, it is probable that the economic benefits associated with the dividend will flow to the entity; and the amount of the dividend can be measured reliably.

## Impairment of financial assets

On initial recognition of the financial assets, a loss allowance for expected credit loss is recognised for debt instruments carried at amortised cost and FVTOCI. For debt instruments that are measured at FVTOCI, the loss allowance is recognised in the statement of profit and loss.

Expected credit losses of a financial instrument is measured in a way that reflects:

- an unbiased and probability-weighted amount that is determined by evaluating a range of possible outcomes;
- the time value of money; and
- reasonable and supportable information that is available without undue cost or effort at the reporting date about past events, current conditions and forecasts of future economic conditions.

At each reporting date, the Company assesses whether the credit risk on a financial instrument has increased significantly since initial recognition.

When making the assessment, the Company compares the risk of a default occurring on the financial instrument as at the reporting date with the risk of a default occurring on the financial instrument as at the date of initial recognition and consider reasonable and supportable information, that is available without undue cost or effort, that is

indicative of significant increases in credit risk since initial recognition.

If, at the reporting date, the credit risk on a financial instrument has not increased significantly since initial recognition, the Company measures the loss allowance for that financial instrument at an amount equal to 12-month expected credit losses. If, the credit risk on that financial instrument has increased significantly since initial recognition, the Company measures the loss allowance for a financial instrument at an amount equal to the lifetime expected credit losses.

For Trade Receivables and Contract Assets, the Company applies the simplified approach required by Ind AS 109, which requires expected life time losses to be recognized from initial recognition of the receivables.

The amount of expected credit losses (or reversal) that is required to adjust the loss allowance at the reporting date is recognised as an impairment gain or loss in the statement of profit and loss.

## De-recognition of financial assets

The Company derecognises a financial asset on trade date only when the contractual rights to the cash flows from the asset expire, or when it transfers the financial asset and substantially all the risks and rewards of ownership of the asset to another entity or when it retains contractual rights to retain contractual cash flows from financial assets, but assumes a contractual obligation to pay the cash flows to one or more recipient. If the Company neither transfers nor retains substantially all the risks and rewards of ownership and continues to control the transferred asset, the Company recognises its retained interest in the asset and an associated liability for amounts it may have to pay. If the Company retains substantially all the risks and rewards of ownership of a transferred financial asset, the Company continues to recognise the financial asset and also recognises a collateralised borrowing for the proceeds received.

On de-recognition of a financial asset other than in its entirety (e.g. when the Company retains an option to repurchase part of a transferred asset), the Company allocates the previous carrying amount of the financial asset between the part it continues to recognise under continuing involvement, and the part it no longer recognises on the basis of the relative fair values of those parts on the date of the transfer. The difference between

# Notes

forming part of the Standalone Financial Statements

the carrying amount allocated to the part that is no longer recognised and the sum of the consideration received for the part no longer recognised and any cumulative gain or loss allocated to it that had been recognised in other comprehensive income is recognised in the statement of profit and loss. Cumulative gain or loss that had been recognised in other comprehensive income is allocated between the part that continues to be recognised and the part that is no longer recognised on the basis of the relative fair values of those parts.

## Financial liabilities and equity instruments issued by the Company

### Classification as debt or equity

Debt and equity instruments are classified as either financial liabilities or as equity in accordance with the substance of the contractual arrangement.

### Equity instruments

An equity instrument is any contract that evidences a residual interest in the assets of an entity after deducting all of its liabilities. Equity instruments issued by the Company are recognised at the proceeds received, net of direct issue costs.

### Compound instruments

The component parts of compound instruments (convertible instruments) issued by the Company are classified separately as financial liabilities and equity in accordance with the substance of the contractual arrangement. At the date of issue, the fair value of the liability component is estimated using the prevailing market interest rate for a similar non-convertible instrument. This amount is recorded as a liability on an amortised cost basis using the effective interest method until extinguished upon conversion or at the instrument's maturity date. The equity component is determined by deducting the amount of the liability component from the fair value of the compound instrument as a whole. This is recognised and included in equity, net of income tax effects, and is not subsequently re-measured.

### Financial guarantee contract liabilities

Financial guarantee contract liabilities are initially measured at their fair values and, if not designated as at FVTPL, are subsequently measured at the higher of:

- the amount of loss allowance is determined by using expected credit loss model as per Ind AS 109; and

- the amount initially recognised less, where appropriate, cumulative amount of income recognised in accordance with the revenue recognition policies.

### Financial liabilities

Financial liabilities are classified as either financial liabilities 'at FVTPL' or 'other financial liabilities'.

### Financial liabilities at FVTPL

Financial liabilities are classified as at FVTPL when the financial liability is either held for trading or it is designated as at FVTPL.

A financial liability is classified as held for trading if:

- it has been acquired or incurred principally for the purpose of repurchasing it in the near term; or
- on initial recognition it is part of a portfolio of identified financial instruments that the Company manages together and for which there is evidence of a recent actual pattern of short-term profit-taking; or
- it is a derivative that is not designated and effective as a hedging instrument.

A financial liability other than a financial liability held for trading may also be designated as at FVTPL upon initial recognition if:

- such designation eliminates or significantly reduces a measurement or recognition inconsistency that would otherwise arise; or
- the financial liability forms part of a group of financial assets or financial liabilities or both, which is managed and its performance is evaluated on a fair value basis, in accordance with the Company's documented risk management or investment strategy, and information about the Company is provided internally on that basis; or
- it forms part of a contract containing one or more embedded derivatives, and Ind-AS 109 Financial Instruments permits the entire combined contract to be designated as at FVTPL.

Financial liabilities at FVTPL are stated at fair value, with any gains or losses arising on re-measurement recognised in the statement of profit and loss, except for the amount of change in the fair value of the financial liability that is

attributable to changes in the credit risk of that liability which is recognised in other comprehensive income.

The net gain or loss recognised in the statement of profit and loss incorporates any interest paid on the financial liability.

### Other financial liabilities

Other financial liabilities, including borrowings, are initially measured at fair value, net of transaction costs.

Other financial liabilities are subsequently measured at amortised cost using the effective interest method, with interest expense recognised on an effective yield basis.

The effective interest method is a method of calculating the amortised cost of a financial liability and of allocating interest expense over the relevant period. The effective interest rate is the rate that exactly discounts estimated future cash payments through the expected life of the financial liability, or (where appropriate) a shorter period, to the net carrying amount on initial recognition.

### Offsetting financial instruments

Financial assets and liabilities are offset and the net amount is reported in the balance sheet when there is a legally enforceable right to offset the recognised amounts and there is an intention to settle on a net basis or realise the asset and settle the liability simultaneously. The legally enforceable right must not be contingent on future events and must be enforceable in the normal course of business and in the event of default, insolvency or bankruptcy of the Company or the counterparty.

See Note 7A and 7B – Other Investments for further details.

See Note 8 – Loans for further details.

See Note 9A and 9B – Other Financial assets for further details.

See Note 14 – Bank Balance other than Cash and Cash Equivalents for further details.

See Note 18A and 18B – Borrowings for further details.

See Note 27 – Other Income for further details.

See Note 36 – Impairment Loss/ (Reversal) on Financial Assets (Net) for further details.

See Note 46 – Offsetting Financial Liabilities and Financial Assets for further details.

See Note 47 – Financial Instruments for further details.

See Note 48 – Financial Risk Management for further details.

See Note 49 – Derivative Financial Instruments for further details.

## Q. Derivatives and hedge accounting

Derivatives are initially recognised at fair value on the date a derivative contract is entered into and are subsequently re-measured at their fair value at the end of each reporting date. The method of recognising the resulting gain or loss depends on whether the derivative is designated as a hedging instrument, and if so, the nature of the item being hedged.

The Company has a policy to designate certain derivatives as either:

- hedges of the fair value of recognised assets or liabilities or a firm commitment (fair value hedge);
- hedges of a particular risk associated with the cash flow of recognised assets or liabilities or a highly probable forecast transaction (cash flow hedge); or

The Company documents at the inception of the transaction the relationship between hedging instruments and hedged items, as well as its risk management objectives and strategy for undertaking various hedging transactions. The Company also documents the nature of the risk being hedged and how the Company will assess whether the hedging relationship meets the hedge effectiveness requirements (including its analysis of the sources of hedge ineffectiveness and how it determines the hedge ratio).

Change in Fair value of derivatives that are not designated in any hedge relationship as mentioned above are accounted through the Statement of Profit and Loss at each reporting date.

The Company also identifies embedded derivatives in certain transactions. These derivatives are generally segregated from the host transactions and accounted for separately. These derivatives are designated into a



# Notes

forming part of the Standalone Financial Statements

hedge relationship if they meet hedge accounting criteria. Change in Fair Value of such embedded derivatives are accounted in Other Comprehensive Income if they are designated in a cash flow hedge relationship. Fair Value change of all other embedded derivatives including those that are not designated in any hedge relationship are accounted through the Statement of Profit and Loss.

The full fair value of a hedging derivative is classified as a non-current asset or liability when the residual maturity of the derivative is more than 12 months and as a current asset or liability when the residual maturity of the derivative is less than 12 months.

## Fair value hedge

Changes in the fair value of derivatives that are designated and qualify as fair value hedges are recorded in the statement of profit and loss, together with any changes in the fair value of the hedged item that are attributable to the hedged risk.

Hedge accounting is discontinued when the hedging instrument expires or is sold, terminated, or exercised, or when it no longer qualifies for hedge accounting. The fair value adjustment to the carrying amount of the hedged item arising from the hedged risk is amortised to the statement of profit and loss from that date except for inventory that is charged to statement of profit and loss on sale of goods.

## Cash flow hedges

The effective portion of changes in the fair value of derivatives that are designated and qualify as cash flow hedges is recognised in other comprehensive income and accumulated under the heading cash flow hedging reserve within equity. The gain or loss relating to the ineffective portion is recognised immediately in the statement of profit and loss, and is included in the '(Gain) / Loss in Fair Value of Derivatives' line item.

Amounts previously recognised in other comprehensive income and accumulated in equity are reclassified to the statement of profit and loss in the periods when the hedged item affects the statement of profit and loss, in the same line as the recognised hedged item. However, when the hedged forecast transaction results in the recognition of a non-financial asset or a non-financial liability, the gains and losses previously recognised in other comprehensive income and accumulated in equity are transferred from equity and included in the initial

measurement of the cost of the non-financial asset or non-financial liability as a basis adjustment.

If the hedge ratio for risk management purposes is no longer optimal but the risk management objective remains unchanged and the hedge continues to qualify for hedge accounting, the hedge relationship will be rebalanced by adjusting either the volume of the hedging instrument or the volume of the hedged item so that the hedge ratio aligns with the ratio used for risk management purposes. Any hedge ineffectiveness is calculated and accounted for in the statement of profit and loss at the time of the hedge relationship rebalancing.

Hedge accounting is discontinued when the hedging instrument expires or is sold, terminated, or exercised, or when it no longer qualifies for hedge accounting. Any gain or loss recognised in other comprehensive income and accumulated in equity at that time remains in equity and is recognised when the forecast transaction is ultimately recognised in the statement of profit and loss. When a forecast transaction is no longer expected to occur, the gain or loss accumulated in equity is recognised immediately in the statement of profit and loss.

See Note 49 – Derivatives Financial Instruments for further details.

## R. Cash and cash equivalents

Cash and cash equivalents comprise of cash at bank and in hand, short-term deposits and short term highly liquid investments with an original maturity of three months or less that are readily convertible to known amounts of cash and are subject to insignificant risk of changes in value

For the purposes of the Cash Flow Statement, cash and cash equivalents is as defined above, net of outstanding bank overdrafts which are integral part of Cash management activities. In the balance sheet, bank overdrafts are shown within borrowings in current liabilities.

See Note 13 – Cash and Cash Equivalents for further details.

## S. Borrowing cost

General and specific borrowing costs directly attributable to the acquisition, construction or production of qualifying assets are added to the cost of those assets, until such time as the assets are substantially ready for their

intended use or sale. The Company considers a period of twelve months or more as a substantial period of time. Qualifying assets are assets that necessarily take a substantial period of time to get ready for their intended use or sale.

Transaction costs in respect of long-term borrowings are amortised over the tenor of respective loans using effective interest method. All other borrowing costs are expensed in the period in which they are incurred.

Investment income earned on the temporary investment of specific borrowings pending their expenditure on qualifying assets is deducted from the borrowing costs eligible for capitalization.

See Note 2 – Property, Plant and Equipment (including ROU Assets) and Capital Work-in-Progress for further details.

See Note 4B - Intangible Assets and Intangible Assets under Development for further details.

See Note 33 – Finance Costs for further details.

## T. Accounting for government grants

Government grants are recognized when there is reasonable assurance that we will comply with the conditions attached to them and that the grants will be received.

Government grants are recognised in the statement of profit and loss on a systematic basis over the periods in which the Company recognises as expenses the related costs for which the grants are intended to compensate. Government grants whose primary condition is that the Company should purchase, construct or otherwise acquire non-current assets are recognized in the balance sheet by setting up the grant as deferred income and its amortization is recognized in 'Other Income' on straight line basis over expected useful lives of related assets.

Other government grants (grants related to income) are recognized as income over the periods necessary to match them with the costs for which they are intended to compensate, on a systematic basis. Government grants that are receivable as compensation for expenses or losses already incurred or for the purpose of providing immediate financial support with no future related costs are recognized in the statement of profit and loss in the period in which they become receivable.

Grants related to income are presented under 'Other Income' or 'Other Operating Revenue' in the statement of profit and loss depending upon the nature of the underlying grant, except for grants received in the form of rebate or exemptions related to expenditures, which are deducted in reporting the related expense.

The benefit of a government loan at a below-market rate of interest is treated as a government grant, measured as the difference between proceeds received and the fair value of the loan based on prevailing market interest rates.

See Note 26 – Revenue from Operations for further details.

See Note 27 – Other Income for further details.

## U. Employee Benefits

### Retirement benefit and termination benefits

A defined contribution plan is a pension plan under which the Company pays fixed contributions into a separate entity. The Company has no legal or constructive obligations to pay further contributions if the fund does not hold sufficient assets to pay all employees the benefits relating to employee service in the current and prior periods. Payments to defined contribution retirement benefit plans are recognised as an expense when employees have rendered service entitling them to the contributions.

For defined benefit retirement and medical plans, the cost of providing benefits is determined using the projected unit credit method, with actuarial valuations being carried out at the end of each annual reporting period. The present value of the defined benefit obligation is determined by discounting the estimated future cash outflows using market yields of government bonds having terms approximating to the terms of related obligation.

Re-measurement, comprising of actuarial gains and losses, the effect of the changes to the asset ceiling (if applicable) and the return on plan assets (excluding interest), is reflected in the balance sheet with a charge or credit recognised in other comprehensive income in the period in which they occur. Re-measurement recognised in other comprehensive income is reflected immediately in retained earnings and will not be reclassified to the statement of profit and loss. Past service cost is recognised in the statement of profit and loss in the period of a plan amendment. Net interest is calculated by

# Notes

forming part of the Standalone Financial Statements

applying the discount rate at the beginning of the period to the net defined benefit liability or asset. Defined benefit costs are categorised as follows:

- service cost (including current service cost, past service cost, as well as gains and losses on curtailments and settlements);
- net interest expense or income; and
- re-measurements

The Company presents the first two components of defined benefit costs in the statement of profit and loss in the line item employee benefits expense. Curtailment gains and losses are accounted for as past service costs.

The retirement benefit obligation recognised in the balance sheet represents the actual deficit or surplus in the Company's defined benefit plans. Any surplus resulting from this calculation is limited to the present value of any economic benefits available in the form of refunds from the plans or reductions in future contributions to the plans.

A liability for a termination benefit is recognised at the earlier of when the entity can no longer withdraw the offer of the termination benefit or when the entity recognises any related restructuring costs which involves the payment of terminations benefits.

In the case of an offer made to encourage voluntary redundancy, the termination benefits are measured based on the number of employees expected to accept the offer. Benefits falling due more than 12 months after the end of the reporting period are discounted to their present value.

#### Short-term and other long-term employee benefits

A liability is recognised for benefits accruing to employees in respect of wages and salaries in the period the related service is rendered at the undiscounted amount of the benefits expected to be paid in exchange for that service.

Liabilities recognised in respect of short-term employee benefits are measured at the undiscounted amount of the benefits expected to be paid in exchange for the related service.

Liabilities recognised in respect of other long-term employee benefits such as annual leave and sick leave are measured at the present value of the estimated future cash

outflows expected to be made by the Company in respect of services provided by employees up to the reporting date. The expected costs of these benefits are accrued over the period of employment using the same accounting methodology as used for defined benefit retirement plans. Actuarial gains and losses arising from experience adjustments and changes in actuarial assumptions are charged or credited to the statement of profit and loss in the period in which they arise. These obligations are valued annually by independent qualified actuaries.

See Note 31 – Employee Benefits for further details

#### V. Employee Share-based Payments

Equity-settled share-based payments to employees are measured at the fair value of the options at the grant date.

The fair value of option at the grant date is expensed over the respective vesting period in which all of the specified vesting conditions are to be satisfied with a corresponding increase in equity as "Employee Stock Options Account". In case of forfeiture of unvested option, portion of amount already expensed is reversed. In a situation where the vested option forfeited or expires unexercised, the related balance standing to the credit of the "Employee Stock Options Account" are transferred to the "Retained Earnings".

When the options are exercised, the Company issues new equity shares of the Company of ₹ 1/- each fully paid-up. The proceeds received and the related balance standing to credit of the Employee Stock Options Account, are credited to share capital (nominal value) and Securities Premium Account.

Share appreciation rights which are cash settled, are recognised as employee benefit expense over the relevant service period. The liability is fair valued at each reporting date and are presented as employee benefit obligations in the balance sheet.

See Note 42 – Employee Share-based Payments for further details

#### W. Income Taxes

Income tax expense represents the sum of the tax currently payable and deferred tax.

#### Current tax

The tax currently payable is based on taxable profit for

the year. Taxable profit differs from 'profit before tax' as reported in the statement of profit and loss because of items of income or expense that are taxable or deductible in other years and items that are never taxable or deductible. The current income tax charge is calculated on the basis of the tax laws enacted or substantively enacted at the balance sheet date.

#### Deferred tax

Deferred tax is recognised on differences between the carrying amounts of assets and liabilities in the balance sheet and the corresponding tax bases used in the computation of taxable profit.

Deferred tax liabilities are generally recognised for all taxable temporary differences.

Deferred tax assets are generally recognised for all deductible temporary differences to the extent that it is probable that taxable profits will be available against which those deductible temporary differences can be utilised. Such assets and liabilities are not recognised if the temporary difference arises from initial recognition of goodwill or from the initial recognition (other than in a business combination) of other assets and liabilities in a transaction that at the time of transaction affects neither the taxable profit nor the accounting profit.

The carrying amount of deferred tax assets is reviewed at each balance sheet date and reduced to the extent that it is no longer probable that sufficient taxable profits will be available to allow all or part of the asset to be recovered.

Deferred tax assets and liabilities are measured at the tax rates that are expected to apply in the period in which the liability is settled or the asset realised, based on tax rates (and tax laws) that have been enacted or substantively enacted by the balance sheet date. The measurement of deferred tax liabilities and assets reflects the tax consequences that would follow from the manner in which the Company expects, at the reporting date, to recover or settle the carrying amount of its assets and liabilities.

Deferred tax assets and liabilities are offset when there is a legally enforceable right to set off when they relate to income taxes levied by the same taxation authority. Current tax assets and tax liabilities are offset where the Company has a legally enforceable right to offset and intends either to settle on a net basis, or to realise the asset and settle the liability simultaneously.

Minimum Alternative Tax (MAT) is recognized as an asset only when and to the extent there is convincing evidence that the Company will pay normal income tax during the specified period. In the year in which the MAT credit becomes eligible to be recognized as an asset, the said asset is created by way of credit to the statement of profit and loss and included in deferred tax assets. The Company reviews the same at each balance sheet date and writes down the carrying amount of MAT entitlement to the extent there is no longer convincing evidence to the effect that Company will pay normal income tax during the specified period.

#### Current and deferred tax for the period

Current and deferred tax are recognised in the statement of profit and loss, except when they relate to items that are recognised in other comprehensive income or directly in equity, in which case, the current and deferred tax are also recognised in other comprehensive income or directly in equity, respectively. Where current tax or deferred tax arises from the initial accounting for a business combination, the tax effect is included in the accounting for the business combination.

Management periodically evaluates positions taken in tax returns with respect to situations in which applicable tax regulation is subject to interpretation and considers whether it is probable that the taxation authority will accept tax position taken by the Company. Uncertain tax positions are reflected in the overall measurement of the Company's tax expense and are based on the most likely amount or the expected value arrived at by the Company which provides a better prediction of the resolution of uncertainty. Uncertain tax positions are monitored and updated as and when new information becomes available, typically upon examination or action by the taxing authorities or through statute expiration and judicial precedent.

The Company considers when a particular amount payable for interest and penalties on income taxes is determined to be within the scope of Ind AS 37, it is presented as part of financing cost or other expenses, respectively unless when there is an overall settlement with tax authority and the interest and penalties cannot be identified separately in which case it is determined to be part of income taxes and accounted under Ind AS 12.

See Note 23 - Income Taxes for further details

# Notes

forming part of the Standalone Financial Statements

## X. Revenue recognition

The Company derives revenue principally from sale of hydrate, speciality alumina, aluminium and aluminium value added products, di-ammonium phosphate, copper, precious metals (gold and silver) and other materials.

The Company recognizes revenue when it satisfies a performance obligation in accordance with the contract with the customer. This is achieved when control of the product has been transferred to the customer, which is generally determined when legal title, physical possession, risk of obsolescence, loss and rewards of ownership pass to the customer and the Company has the present right to payment, all of which occurs at a point in time upon shipment or delivery of the product. The Company considers shipping and handling activities as costs to fulfil the promise to transfer the related products and the customer payments for shipping and handling costs are recorded as a component of revenue.

In situations where revenue is recognized on shipment of goods, shipping and handling services are treated as a distinct separate performance obligation and the Company recognises revenue for such services when the performance obligation is completed.

The Company considers the terms of the contract in determining the transaction price. The transaction price is based upon the amount the Company expects to be entitled to in exchange for transferring of promised goods and services to the customer after deducting incentive programs, including but not limited to discounts, volume rebates etc. Transaction price excludes taxes and duties collected on behalf of the government.

For incentives offered to customers, the Company makes estimates related to customer performance and sales volume to determine the total amounts earned and to be recorded as deductions from "Revenue from contracts with customers". In making these estimates, the Company considers historical results that have a predictive value of the amount that the Company expects to be entitled to for the transferred goods and services. If historical results have limited predictive value or the Company has limited experience with similar types of incentives, the estimate is made in such a manner, which ensures that it is highly probable that a significant reversal in the amount of cumulative revenue recognised will not occur. The actual amounts may differ from these estimates and are accounted for prospectively. No element of significant

financing is deemed present as the sales are made with a credit term, which is consistent with market practice. The Company's obligation to repair or replace faulty products under the standard warranty terms is recognised as a cost with a corresponding provision.

For certain customer contracts, final prices are determined based on the underlying market index of commodity prices at a future date, for example prices on the London Metal Exchange Limited (LME) or London Bullion Markets Association (LBMA). In such contracts, the Company records revenue on a provisional basis considering current market price when control is transferred to the customer. At the end of each period, prior to final settlement date, adjustments are made to the provisional sale price based on movements in the underlying market index of commodity prices up to the date of final price determination. Such variable price movement is accounted as 'Other Operating Revenue'.

Revenue from irrevocable bill and hold/ holding certificate contracts is recognised when it is probable that delivery will be made, goods have been identified and kept separately, are ready for delivery in the present condition and the Company does not have the ability to use the product or to direct it to another customer. Under these arrangements, revenue is recognised once legal title has passed and control of the asset sold is transferred to the customer.

Export incentives and subsidies are recognized when there is reasonable assurance that the Company will comply with the conditions and the incentive will be received.

Claim on insurance companies, railway authorities and others are accounted for on acceptance basis.

Revenue excludes any taxes and duties collected on behalf of the government.

### Contract liability

Contract liability is recognised when a payment for customer is already received before a related performance obligation is satisfied. If a customer pays consideration before the Company transfers goods or services to the customer, a contract liability is recognised when the payment is received.

As these are contracts that the Company expects, and has

the ability, to fulfil through delivery of a non-financial item, these are presented as advance from customers and are recognised as revenue as and when control of respective commodities is transferred or service is provided to the customers under the agreements. The portion of the advance where either the Company does not have a unilateral right to defer settlement beyond twelve months or expects settlement within twelve months from the balance sheet date is classified as a current liability.

See Note 24 – Contract Liabilities for further details

See Note 26 – Revenue from Operations for further details

## Y. Dividend and Interest Income

Dividend income from investments is recognised when the shareholder's right to receive payment has been established.

Interest income from a financial asset is recognised when it is probable that the economic benefits will flow to the Company and the amount of income can be measured reliably. Interest income is accrued on a time basis, by reference to the principal outstanding and at the effective interest rate applicable, which is the rate that exactly discounts estimated future cash receipts through the expected life of the financial asset to that asset's net carrying amount on initial recognition.

See Note 27 – Other Income for further details

## Z. Exceptional items

Exceptional items include income or expense that are considered to be part of ordinary activities, however are of such significance and nature that separate disclosure enables the user of the financial statements to understand the impact in a more meaningful manner. Exceptional items are identified by virtue of their size, nature and incidence.

See Note 38 – Exceptional Income/ (Expenses) (Net) for further details

## AA. Business Combination

Business combinations are accounted for using the acquisition method. The consideration transferred in a business combination comprises the fair values of the assets transferred, liabilities incurred to the former owners of the acquired business, equity interests issued by the Company and fair value of any assets or liability

resulting from a contingent consideration arrangement. Acquisition-related costs are expensed as incurred.

At the acquisition date, the identifiable assets acquired and liabilities and contingent liabilities assumed in a business combination are measured at their acquisition date fair values. However, certain assets and liabilities i.e. deferred tax assets or liabilities, assets or liabilities related to employee benefit arrangements, liabilities or equity instruments related to share-based payment arrangements, lease liabilities under Ind AS 116 and assets or disposal groups that are classified as held for sale, acquired or assumed in a business combination are measured as per the applicable Ind-AS.

The excess of the consideration transferred over the fair value of the net identifiable assets acquired is recorded as goodwill.

Any gain on a bargain purchase is recognised in other comprehensive income and accumulated in equity as Capital Reserve if there exists clear evidence of the underlying reasons for classifying the business combination as resulting in a bargain purchase, otherwise the gain is recognised directly in equity as Capital Reserve.

Where settlement of any part of cash consideration is deferred, the amounts payable in future are discounted to their present value as at the date of exchange. The discount rate used is entity's incremental borrowing rate, being the rate at which similar borrowing could be obtained from an independent financier under comparable terms and conditions. Any contingent consideration is measured at fair value at the date of acquisition. If an obligation to pay contingent consideration that meets the definition of a financial instrument is classified as equity, then it is not re-measured subsequently and settlement is accounted for within equity. Other contingent consideration is re-measured at fair value at each reporting date and changes in the fair value of contingent consideration are recognised in profit or loss.

When a business combination is achieved in stages, any previously held equity interest in the acquiree is re-measured at its acquisition-date fair value and the resulting gain or loss, if any, is recognised in the statement of profit and loss or other comprehensive income, as appropriate.

Where it is not possible to complete the determination



# Notes

forming part of the Standalone Financial Statements

of fair values by the end of the reporting period in which the combination occurs, a provisional assessment of fair values is made and any adjustments required to those provisional values, and the corresponding adjustments to goodwill, are finalised within 12 months of the acquisition date.

See Note 53 – for further details

## 1C. Measurement of fair value

### a. Financial instruments

The estimated fair value of the Company's financial instruments is based on market prices and valuation techniques. Valuations are made with the objective to include relevant factors that market participants would consider in setting a price, and to apply accepted economic and financial methodologies for the pricing of financial instruments. References for less active markets are carefully reviewed to establish relevant and comparable data.

### b. Marketable and non-marketable equity securities

Fair value for listed shares is based on quoted market prices as of the reporting date. Fair value for unlisted shares is calculated based on commonly accepted valuation techniques utilizing significant unobservable data, primarily cash flow based models.

### c. Derivatives

Fair value of financial derivatives is estimated as the present value of future cash flows, calculated by reference to quoted price curves and exchange rates as of the balance sheet date. Options are valued using appropriate option pricing models and credit spreads are applied where deemed to be significant.

### d. Embedded derivatives

Embedded derivatives that are separated from the host contract are valued by comparing the forward curve at contract inception to the forward curve as of the balance sheet date. Changes in the present value of the cash flows related to the embedded derivative are recognized in the balance sheet and in the income statement.

## 1D. Critical accounting judgment and key sources of estimation uncertainty

In preparing the financial statements in conformity with accounting principles generally accepted in India, management is required to make estimates and assumptions that affect reported amounts of assets and liabilities and the disclosure of contingent liabilities as at the date of the financial statements and the amounts of revenue and expenses during the reported period. Actual results could differ from those estimates. Any revision to such estimates is recognised in the period in which the same is determined.

The following paragraphs explain areas that are considered more critical, involving a higher degree of judgment and complexity.

### a. Impairment of non-current assets

Ind AS 36 requires that the Company assesses conditions that could cause an asset or a Cash Generating Unit (CGU) to become impaired and to test recoverability of potentially impaired assets. These conditions include changes resulting from market and economic environment, including internal and external factors such as the Company's market capitalization, significant changes in the Company's planned use of the assets or a significant adverse change in the expected prices, sales volumes or raw material cost. The identification of CGUs involves judgment, including assessment of where active markets exist, and the level of interdependency of cash inflows. CGU is usually the individual plant, unless the asset or asset Company is an integral part of a value chain where no independent prices for the intermediate products exist, a Company of plants is combined and managed to serve a common market, or where circumstances otherwise indicate significant interdependencies.

In accordance with Ind-AS 36, certain intangible assets are reviewed at least annually for impairment. If a loss in value is indicated, the recoverable amount is estimated as the higher of the CGU's fair value less cost to sell, or its value in use. Directly observable market prices rarely exist for the Company's assets, however, fair value may be estimated based on recent transactions on comparable assets, internal models used by the Company for transactions involving the same type of assets or other relevant

information. Calculation of value in use is a discounted cash flow calculation based on continued use of the assets in its present condition, excluding potential exploitation of improvement or expansion potential.

Determination of the recoverable amount involves management estimates on highly uncertain matters, such as commodity prices and their impact on markets and prices for upgraded products, development in demand, inflation, currency rate movements, input cost prices, operating expenses and tax and legal environment. The Company uses internal business plans, quoted market prices and the Company's best estimate of commodity prices, currency rates, discount rates and other relevant information. A detailed forecast is developed for a period of three to five years with projections thereafter.

### b. Employee retirement plans

The Company provides both defined benefit employee retirement plans and defined contribution plans. Measurement of pension and other superannuation costs and obligations under such plans require numerous assumptions and estimates that can have a significant impact on the recognized costs and obligation, such as future salary level, discount rate, attrition rate and mortality.

The Company provides defined benefit plans to its employees. The discount rate is based on Government bond yield. Assumptions for salary increase in the remaining service period for active plan participants are based on expected salary increase in India. Changes in these assumptions can influence the net asset or liability for the plan as well as the pension cost, refer note 31.

### c. Environmental liabilities and Asset Retirement Obligation (ARO)

Estimation of environmental liabilities and ARO require interpretation of scientific and legal data, in addition to assumptions about probability and future costs, refer note 22.

### d. Taxes

The Company calculates income tax expense based on reported income. Deferred income tax expense is calculated based on the differences between the

carrying value of assets and liabilities for financial reporting purposes and their respective tax basis that are considered temporary in nature. Valuation of deferred tax assets is dependent on management's assessment of future recoverability of the deferred tax benefit. Expected recoverability may result from expected taxable income in the future, planned transactions or planned tax optimizing measures. Economic conditions may change and lead to a different conclusion regarding recoverability, refer notes 25. For judgements related to adoption of lower tax rate as per Section 115BBA of the Income tax Act, refer note 23.

### e. Extension and termination option in a Lease

Extension and termination options are included in many of the leases. In determining the lease term, the Management considers all facts and circumstances that create an economic incentive to exercise an extension option, or not exercise a termination option. This assessment is reviewed if a significant event or a significant change in circumstances occurs which affects this assessment and that is within the control of the Company.

### f. Useful lives of depreciable/ amortisable assets (tangible and intangible)

Management reviews its estimate of the useful lives of depreciable/ amortisable assets at each reporting date, based on the expected utility of the assets. Uncertainties in these estimates relate to technical and economic obsolescence that may change the utility of certain software, IT equipment and other plant and equipment.

### g. Recoverability of advances/ receivables

At each balance sheet date, based on discussions with the respective counter-parties and internal assessment of their credit worthiness, the management assesses the recoverability of outstanding receivables and advances. Such assessment requires significant management judgement based on financial position of the counter-parties, market information and other relevant factors.

### h. Fair value measurements

The Company applies valuation techniques to determine the fair value of financial instruments (where active market quotes are not available)

# Notes

forming part of the Standalone Financial Statements

and non-financial assets. This involves developing estimates and assumptions consistent with the market participants to price the instrument. The Company's assumptions are based on observable data as far as possible, otherwise on the best information available. Estimated fair values may vary from the actual prices that would be achieved in an arm's length transaction at the reporting date, refer note 47.

## i. Contingent assets and liabilities, provisions and uncertain tax positions

There are various legal, direct and indirect tax matters and other obligations including environmental, mining, local and state levies, income tax holiday, availing input tax credits etc., which may impact the Company. Evaluation of uncertain liabilities and contingent liabilities and assets arising out of above matters require management judgment and assumptions, regarding the probability outflow or realization of economic resources and the timing and amount, or range of amounts, that may ultimately be determined. Such estimates may vary from the ultimate outcome as a result of differing interpretations of laws and facts, or application of relevant judicial precedents, refer notes 22, 23 and 44.

## j) Inventory Measurement

Measurement of bulk inventory quantities (such as coal, bauxite, copper concentrates, etc.) lying at yards and work in progress of precious metals at smelter and refinery is material, complex and involves significant judgement and estimate resulting from measuring the surface area, dip measurement of materials in tanks/silos, etc., refer note 11.

The Company performs physical counts of above inventory on a periodic basis using internal / external experts to perform volumetric surveys and assessments, basis which the estimate of quantity for these inventories is determined. The variations noted between book records and physical quantities of above inventories are evaluated and appropriately accounted in the books of accounts.

## 1E. Recent Accounting Pronouncements

### i) New and amended standards adopted by the Company

The Company has adopted the following amendments for the first time for their annual reporting period commencing 1 April 2021:

- a) On March 24, 2021, the Ministry of Corporate Affairs ("MCA") through a notification, amended Schedule III of the Companies Act, 2013. The amendments revise Division I, II and III of Schedule III and are applicable from April 1, 2021. Key amendments relating to Division II which relate to companies whose financial statements are required to comply with Companies (Indian Accounting Standards) Rules 2015 are:

#### Balance Sheet:

- Lease liabilities should be separately disclosed under the head 'financial liabilities', duly distinguished as current or non-current.
- Certain additional disclosures in the statement of changes in equity such as changes in equity share capital due to prior period errors and restated balances at the beginning of the current reporting period.
- Specified format for disclosure of shareholding of promoters.
- Specified format for ageing schedule of trade receivables, trade payables, capital work-in-progress and intangible asset under development.
- If a company has not used funds for the specific purpose for which it was borrowed from banks and financial institutions, then disclosure of details of where it has been used.
- Specific disclosure under 'additional regulatory requirement' such as compliance with approved schemes of arrangements, compliance with number of layers of companies, title deeds of immovable property not held in name of company, loans and advances to promoters, directors, key managerial personnel (KMP) and related parties, details of benami property held, certain specified ratios etc.

#### Statement of profit and loss:

- Additional disclosures relating to Corporate Social Responsibility (CSR), undisclosed income and crypto or virtual currency specified under the head 'additional information' in the notes forming part of the standalone financial statements.

Refer note 57 (a) for Schedule III reclassification entry.

- b) Extension of COVID-19 related concessions – amendments to Ind AS 116
- c) Interest rate benchmark reform – amendments to Ind AS 109, Financial Instruments, Ind AS 107, Financial Instruments: Disclosures, Ind AS 104, Insurance Contracts and Ind AS 116, Leases.

The amendments listed above did not have any impact on the amounts recognised in prior periods and are not expected to significantly affect the current or future periods.

### i) Amended applicable from next financial year

Ministry of Corporate Affairs ("MCA") notifies new standards or amendments to the existing standards under Companies (Indian Accounting Standards) Rules as issued from time to time. On March 23, 2022, MCA amended the Companies (Indian Accounting Standards) Amendment Rules, 2022, as below.

**Ind AS16–Property Plant and equipment** - The amendment clarifies that excess of net sale proceed of items produced over the cost of testing, if any, shall not be recognised in the profit or loss but deducted from the

directly attributable costs considered as part of cost of an item of property, plant, and equipment. The effective date for adoption of this amendment is annual periods beginning on or after April 1, 2022. The Company has evaluated the amendment and there is no impact on its financial statements.

**Ind AS37 – Provisions, Contingent Liabilities and Contingent Assets** –The amendment specifies that the 'cost of fulfilling' a contract comprises the 'costs that relate directly to the contract'. Costs that relate directly to a contract can either be incremental costs of fulfilling that contract (examples would be direct labour, materials) or an allocation of other costs that relate directly to fulfilling contracts (an example would be the allocation of the depreciation charge for an item of property, plant and equipment used in fulfilling the contract).

**Onerous Contracts (Cost of Fulfilling a Contract)** - An entity shall apply those amendments to contracts for which it has not yet fulfilled all its obligations at the beginning of the annual reporting period in which it first applies the amendments. The entity shall not restate comparative information. Instead, the entity shall recognise the cumulative effect of initially applying the amendments as an adjustment to the opening balance of retained earnings or other component of equity, as appropriate, at the date of initial application.

The effective date for adoption of this amendment is annual periods beginning on or after April 1, 2022, although early adoption is permitted. The Company has evaluated the amendment and the impact is not expected to be material.

# Notes

forming part of the Standalone Financial Statements

## 2. Property, Plant and Equipment (including Right of Use Assets) and Capital Work-in-Progress

Refer Note 1B (D) for accounting policy on Property, Plant and Equipment

Refer Note 1B (I) for accounting policy on Impairment of Non-Current Assets

Refer Note 1B (L) for accounting policy on Leases

Refer Note 1B (S) for accounting policy on Borrowing cost

(₹ in Crore)		
	As at	
	31/03/2022	31/03/2021
<b>Summary of Property, Plant and Equipment (including Right of Use Assets) given below:</b>		
Property, Plant and Equipment - Cost	50,394	49,291
Less: Accumulated Depreciation and Impairment	19,468	18,056
<b>Net Carrying amount of Property, Plant and Equipment (A)</b>	<b>30,926</b>	<b>31,235</b>
Right of Use Assets	1,020	999
Less: Accumulated Depreciation and Impairment	187	173
<b>Net Carrying amount of Right of Use Assets (B)</b>	<b>833</b>	<b>826</b>
<b>Property, Plant and Equipment (including Right of Use Assets) (A+B)</b>	<b>31,759</b>	<b>32,061</b>
<b>Capital Work-in-Progress (CWIP)</b>	<b>1,573</b>	<b>1,587</b>

### A Property, Plant and Equipment

(₹ in Crore)															
Particulars	ORIGINAL COST					ACCUMULATED DEPRECIATION				ACCUMULATED IMPAIRMENT				NET CARRYING AMOUNT	
	As at April 01, 2021	Additions	Addition due to acquisition *	Disposal/ Adjust-ments	As at March 31, 2022	As at April 01, 2021	Additions	Disposal/ Adjust-ments	As at March 31, 2022	As at April 01, 2021	Recognised/ (Reversed)	Disposal/ Adjust-ments	As at March 31, 2022	As at March 31, 2022	As at March 31, 2021
Freehold Land	611	5	22	-	638	14	4	-	18	1	-	-	1	619	596
Buildings	8,178	176	53	(18)	8,389	2,210	263	(6)	2,467	86	14	-	100	5,822	5,882
Plant and Machinery	39,001	1,022	56	(262)	39,817	14,229	1,213	(187)	15,255	689	62	(5)	746	23,816	24,083
Vehicles and Aircraft	447	38	-	(41)	444	242	28	(31)	239	-	-	-	-	205	205
Railway Wagons	189	-	-	-	189	103	10	-	113	-	-	-	-	76	86
Railway Sidings	496	10	-	-	506	204	28	-	232	17	-	-	17	257	275
Furniture and Fixtures	152	24	-	(2)	174	101	9	(2)	108	1	-	-	1	65	50
Office Equipment	217	29	1	(10)	237	158	21	(9)	170	1	-	-	1	66	58
<b>Total</b>	<b>49,291</b>	<b>1,304</b>	<b>132</b>	<b>(333)</b>	<b>50,394</b>	<b>17,261</b>	<b>1,576</b>	<b>(235)</b>	<b>18,602</b>	<b>795</b>	<b>76</b>	<b>(5)</b>	<b>866</b>	<b>30,926</b>	<b>31,235</b>

\* refer note 53 Business Combination

(₹ in Crore)															
Particulars	ORIGINAL COST					ACCUMULATED DEPRECIATION				ACCUMULATED IMPAIRMENT				NET CARRYING AMOUNT	
	As at April 01, 2020	Additions	Addition due to acquisition	Disposal/ Adjust-ments	As at March 31, 2021	As at April 01, 2020	Additions	Disposal/ Adjust-ments	As at March 31, 2021	As at April 01, 2020	Recognised/ (Reversal)	Disposal/ Adjust-ments	As at March 31, 2021	As at March 31, 2021	As at March 31, 2020
Freehold Land	598	5	-	8	611	8	4	2	14	-	-	1	1	596	590
Buildings	8,036	110	-	32	8,178	1,919	275	16	2,210	59	23	4	86	5,882	6,058
Plant and Machinery	38,526	559	-	(84)	39,001	13,072	1,222	(65)	14,229	638	48	3	689	24,083	24,816
Vehicles and Aircraft	440	16	-	(9)	447	220	26	(4)	242	-	-	-	-	205	220
Railway Wagons	189	-	-	-	189	93	10	-	103	-	-	-	-	86	96
Railway Sidings	489	7	-	-	496	176	28	-	204	17	-	-	17	275	296
Furniture and Fixtures	136	19	-	(3)	152	97	6	(2)	101	1	-	-	1	50	38
Office Equipment	200	24	-	(7)	217	146	19	(7)	158	1	-	-	1	58	53
<b>Total</b>	<b>48,614</b>	<b>740</b>	<b>-</b>	<b>(63)</b>	<b>49,291</b>	<b>15,731</b>	<b>1,590</b>	<b>(60)</b>	<b>17,261</b>	<b>716</b>	<b>71</b>	<b>8</b>	<b>795</b>	<b>31,235</b>	<b>32,167</b>

- (a) For the details of assets for which registration/ transfer is pending, refer note 50.
- (b) The Company's share in Jointly owned assets has been grouped together with the relevant class of Property, Plant and Equipment and Capital Work-in-Progress. The proportion of the Original Cost and Carrying amount included in relevant class of assets are given below:

(₹ in Crore)				
	31/03/2022		31/03/2021	
	Original Cost	Net Carrying Amount	Original Cost	Net Carrying Amount
Freehold Land	52	52	52	52
Buildings	54	40	50	37
Plant and Machinery	6	1	6	2
Furniture & Fixtures	27	22	14	10
Vehicles and Aircraft	-	-	-	-
Office Equipment	9	2	9	2
Capital Work-in-Progress	101	101	104	104

### (c) Assets pledged and Hypothecated against borrowings:

- i All the movable and immovable items of Property, Plant and Equipment of Mahan Aluminium unit, both present and future, carrying value ₹ 11,238 crore (as at 31/03/2021 ₹ 11,609 crore) are given as security towards first ranking pari passu charge against the rupee term loans from banks of ₹ 2,934 crore (gross) (as at 31/03/2021 ₹ 2,942 crore). All the movable items of Property, Plant and Equipment and immovable properties of Mahan Aluminium unit, both present and future are given as first ranking pari passu charge against the rupee term loan of ₹ 2,500 crore, refer note - 18A (b).
- ii All the movable and immovable items of Property, Plant and Equipment of Aditya Aluminium unit both present and future, carrying value of ₹ 11,693 crore (as at 31/03/2021 ₹ 12,029 crore) are given as security towards first ranking pari passu charge against the rupee term loan from bank of ₹ 6,299 crore (gross) (as at 31/03/2021 ₹ 6,299 crore), refer note - 18A (b).



# Notes

forming part of the Standalone Financial Statements

iii All movable items of Property, Plant and Equipment both present and future (except movable items of Mahan Aluminium, Aditya Aluminium, Kalwa Plant and current assets of the Company) and certain immovable properties of the Company are given as security towards Non-Convertible Debentures of ₹ 6,000 crore (gross) (as at 31/03/2021 ₹ 6,000 crore), refer note - 18A (a).

(d) For capital expenditures contracted but not incurred, refer note 44B.

(e) Capital Work-in-Progress comprise of various projects and expansions spread over all units. Many of these projects will be capitalized during the year ending March 31, 2023. The Company has tested the carrying value of Capital Work-in-Progress for impairment as at reporting date. During the current year, the Company has impaired certain mining assets which were under CWIP amounting to ₹ 19 crore, refer note 35 for further details.

Major Capital Work-in-Progress are related to following divisions:

Divisions	(₹ in Crore)	
	31/03/2022	31/03/2021
Aluminium	1,352	1,189
Copper	119	293
Corporate	102	105
<b>Total</b>	<b>1,573</b>	<b>1,587</b>

(f) During the current year, interest capitalised on qualifying assets is ₹ 18 crore (year ended 31/03/2021 ₹ 9 crore), refer note 33 for further details.

(g) Capital Work-in-Progress (CWIP) ageing schedule as at 31/03/2022

Particulars	(₹ in Crore)				Total
	Amount in CWIP for a period of				
	Less than 1 year	1-2 years	2-3 years	More than 3 years	
Projects in progress	835	354	96	87	1,372
Projects temporarily suspended	1	2	21	177	201
<b>Total</b>	<b>836</b>	<b>356</b>	<b>117</b>	<b>264</b>	<b>1,573</b>

Capital Work-in-Progress (CWIP) ageing schedule as at 31/03/2021

Particulars	(₹ in Crore)				Total
	Amount in CWIP for a period of				
	Less than 1 year	1-2 years	2-3 years	More than 3 years	
Projects in progress	791	412	141	93	1,437
Projects temporarily suspended	2	10	22	116	150
<b>Total</b>	<b>793</b>	<b>422</b>	<b>163</b>	<b>209</b>	<b>1,587</b>

(h) CWIP completion schedule for projects, whose completion is overdue or has exceeded its cost compared to its original plan as at 31/03/2022 are given below:

Project name	(₹ in Crore)				Total
	Less than 1 year	1-2 years	2-3 years	More than 3 years	
<b>(i) Project in Progress</b>					
Installation of Transformer Rectifier at Electrostatic Precipitator at Muri plant	7	-	-	-	7
Construction of RCC retaining wall & drainage system at Red Mud Pond at Muri plant	3	-	-	-	3
Powder Coating facility for Extruded Profiles at Alupuram plant	3	-	-	-	3
Electronic Governing System for one Black Start DG at Mahan plant	4	-	-	-	4
Installation of Desulphurization System at Hirakud Power plant	22	-	-	-	22
Bare Fin Stock Manufacturing at Mouda plant	9	-	-	-	9
Zero Liquid Discharge Plant at Taloja plant	1	-	-	-	1
Bag filter at Captive Power Plant Dahej unit	2	-	-	-	2
Construction of permanent sheds at Dahej plant	3	-	-	-	3
Installation of Tail Gas Scrubber System in Sulphuric Acid Plant at Dahej plant	3	-	-	-	3
Wind screen for open coal & rack storage yard at Dahej plant	1	-	-	-	1
Degreasing and Circle Blanking Line at Renukoot Rolled plant	7	-	-	-	7
Extrusion Press at Renukoot Extrusion plant	2	-	-	-	2
Electro Static Precipitators for boilers of Renusagar Power plant	18	-	-	-	18
Others*	31	-	-	-	31
<b>(ii) Project temporarily suspended</b>					
Slow cooled converter slag and part Flash Smelting Furnace slag at Dahej plant	-	69	-	-	69
Construction of New Office Building, Mumbai	-	-	-	73	73
<b>Total</b>	<b>116</b>	<b>69</b>	<b>-</b>	<b>73</b>	<b>258</b>

No Projects in above table are presented due to Cost overrun.

\* It represents the projects having budgeted capital expenditure amount below ₹ 5 crore.

# Notes

forming part of the Standalone Financial Statements

CWIP completion schedule for projects, whose completion is overdue or has exceeded its cost compared to its original plan as at 31/03/2021 are given below:

Project name	To be completed in				Total
	(₹ in Crore)				
	Less than 1 year	1-2 years	2-3 years	More than 3 years	
<b>(i) Project in Progress</b>					
Capacity Augmentation of Red mud Pond at Muri plant	2	-	-	-	2
Installation of Transformer Rectifier at Electrostatic Precipitator at Muri plant	-	7	-	-	7
Track Hopper at Coal Handling at Aditya plant	-	56	-	-	56
Nickle Cadmium station battery charger at Aditya plant	-	4	-	-	4
Suspended Particulate Matter (SPM) reduction at 6 units of Electro Static Precipitators at Aditya plant	-	18	-	-	18
Sectionalizer at 220 KV bus of Aditya plant	-	5	-	-	5
Procurement and Installation of 100 MVA Power Transformer at Hirakud Smelter plant	5	-	-	-	5
Installation of Desulphurization System at Hirakud Power plant	-	5	-	-	5
Degreasing and Circle Blanking Line at Renukoot Rolled Plant	-	82	-	-	82
New 6" Extrusion Press at Renukoot Extrusion Plant	-	47	-	-	47
Electro Static Precipitators for boilers of Renusagar Power Plant	-	21	-	-	21
Annealing Furnace for Flat Rolled Products at Mouda plant	6	-	-	-	6
Ambient Air Quality Monitoring System at Dahej plant	-	2	-	-	2
Bag filter at Captive Power Plant Dahej plant	-	6	-	-	6
Heat Exchanger at Dahej plant	-	8	-	-	8
Wind screen for open coal & rack storage yard at Dahej plant	-	7	-	-	7
Tertiary water recycling unit at Dahej plant	-	50	-	-	50
Slow cooled converter slag and part Flash Smelting Furnace slag at Dahej plant	-	-	68	-	68
Powder Coating facility for Extruded Profiles at Alupuram plant	-	2	-	-	2
Zero Liquid Discharge Plant at Taloja plant	-	1	-	-	1
Aditya Birla Centre, Mumbai	20	-	-	-	20
Others*	12	30	-	-	42
<b>ii) Project temporarily suspended</b>					
Construction of New Office Building, Mumbai	-	-	-	73	73
<b>Total</b>	<b>45</b>	<b>351</b>	<b>68</b>	<b>73</b>	<b>537</b>

No Projects in above table are presented due to Cost overrun.

\* It represents the projects having budgeted capital expenditure amount below ₹ 5 crore.

(i) Items of Property, Plant and Equipment	Useful Life (Years)
Freehold land	Infinite ^
Buildings	30-60
Plant and Machinery	15-40
Vehicles and Aircraft	8-20
Railway Wagons	15
Railway Sidings	15
Furniture and Fixtures	8-10
Office Equipment	3-6

^ Freehold land used for mining is depreciated over 8 - 30 years.

- (j) Residual values and useful live of Property, Plant and Equipment are reviewed, and adjusted if appropriate, at the end of each reporting period. The Company has not revalued its property, plant and equipment (including right-of-use assets) or intangible assets or both during the current or previous year.
- (k) During the current year, the Company has impaired certain assets related to Di Ammonium Phosphate (DAP) plant amounting to ₹ 76 crore, refer note 35 for further details.

## B Right of Use Assets

The Company leases many assets including Land, Buildings, Plant and Machinery, Vehicles, Railway Wagons, Railway Sidings, Furniture etc. These right of use assets are presented as part of 'Property, Plant and Equipment' under Non-Current assets on the face of the Balance Sheet.

Particulars	(₹ in Crore)													
	ORIGINAL COST				ACCUMULATED DEPRECIATION				ACCUMULATED IMPAIRMENT				NET CARRYING AMOUNT	
	As at April 01, 2021	Additions	Disposal/ Adjust-ments	As at March 31, 2022	As at April 01, 2021	Additions	Disposal/ Adjust-ments	As at March 31, 2022	As at April 01, 2021	Recognised/ (Reversed)	Deduction/ Adjust-ments	As at March 31, 2022	As at March 31, 2022	As at March 31, 2021
Leasehold Land	760	57	(34)	783	54	32	(21)	65	-	-	-	-	718	706
Buildings	84	15	(10)	89	44	26	(10)	60	-	-	-	-	29	40
Plant and Machinery	83	30	(60)	53	50	14	(37)	27	-	-	-	-	26	33
Vehicles and Aircraft	19	29	(6)	42	10	10	(6)	14	-	-	-	-	28	9
Railway Wagons	41	-	-	41	8	4	-	12	-	-	-	-	29	33
Railway Sidings	2	-	-	2	-	-	-	-	-	-	-	-	2	2
Furniture and Fixtures	10	-	-	10	7	2	-	9	-	-	-	-	1	3
<b>Total</b>	<b>999</b>	<b>131</b>	<b>(110)</b>	<b>1,020</b>	<b>173</b>	<b>88</b>	<b>(74)</b>	<b>187</b>	<b>-</b>	<b>-</b>	<b>-</b>	<b>-</b>	<b>833</b>	<b>826</b>

# Notes

forming part of the Standalone Financial Statements

(₹ in Crore)

Particulars	ORIGINAL COST				ACCUMULATED DEPRECIATION				ACCUMULATED IMPAIRMENT				NET CARRYING AMOUNT	
	As at April 01, 2020	Additions	Disposal/ Adjustments	As at March 31, 2021	As at April 01, 2020	Additions	Disposal/ Adjustments	As at March 31, 2021	As at April 01, 2020	Recognised/ (Reversed)	Deduction/ Adjustments	As at March 31, 2021	As at March 31, 2021	As at March 31, 2020
	Leasehold Land	750	4	6	760	19	28	7	54	-	-	-	-	706
Buildings	84	9	(9)	84	25	27	(8)	44	-	-	-	-	40	59
Plant and Machinery	61	4	18	83	43	12	(5)	50	-	-	-	-	33	18
Vehicles and Aircraft	22	-	(3)	19	6	7	(3)	10	-	-	-	-	9	16
Railway Wagons	41	-	-	41	4	4	-	8	-	-	-	-	33	37
Railway Sidings	21	-	(19)	2	9	-	(9)	-	-	-	-	-	2	12
Furniture and Fixtures	10	-	-	10	5	2	-	7	-	-	-	-	3	5
<b>Total</b>	<b>989</b>	<b>17</b>	<b>(7)</b>	<b>999</b>	<b>111</b>	<b>80</b>	<b>(18)</b>	<b>173</b>	<b>-</b>	<b>-</b>	<b>-</b>	<b>-</b>	<b>826</b>	<b>878</b>

(a) Disposal/ Adjustments for the lease hold land includes ₹ 16 crore (31/03/2021 ₹ 35 crore) transferred from right of use assets to mining rights under intangible assets in note 4B.

### C Lease liabilities recognised against Right of Use Assets are as follows:

(₹ in Crore)

	As at			
	31/03/2022		31/03/2021	
	Non-Current	Current	Non-Current	Current
Lease liabilities against Right of Use Assets	277	65	236	75
	<b>277</b>	<b>65</b>	<b>236</b>	<b>75</b>

### 3. Investment Properties

Refer Note 1B (E) for accounting policy on Investment properties

Refer Note 1B (I) for accounting policy on Impairment of Non-Current Assets

(₹ in Crore)

	As at	
	31/03/2022	31/03/2021
	Cost	13
Less: Accumulated Depreciation and Impairment	5	5
<b>Net Carrying amount</b>	<b>8</b>	<b>8</b>

(₹ in Crore)

Particulars	ORIGINAL COST				ACCUMULATED DEPRECIATION				ACCUMULATED IMPAIRMENT				NET CARRYING AMOUNT	
	As at April 01, 2021	Addition	Disposal/ Adjustments	As at March 31, 2022	As at April 01, 2021	Addition	Disposal/ Adjustments	As at March 31, 2022	As at April 01, 2021	Recognised/ (Reversed)	Disposal/ Adjustments	As at March 31, 2022	As at March 31, 2022	As at March 31, 2021
	Freehold Land	1	-	-	1	-	-	-	-	-	-	-	-	1
Buildings	12	-	-	12	5	-	-	5	-	-	-	-	7	7
<b>Total</b>	<b>13</b>	<b>-</b>	<b>-</b>	<b>13</b>	<b>5</b>	<b>-</b>	<b>-</b>	<b>5</b>	<b>-</b>	<b>-</b>	<b>-</b>	<b>-</b>	<b>8</b>	<b>8</b>

(₹ in Crore)

Particulars	ORIGINAL COST				ACCUMULATED DEPRECIATION				ACCUMULATED IMPAIRMENT				NET CARRYING AMOUNT	
	As at April 01, 2020	Addition	Disposal/ Adjustments	As at March 31, 2021	As at April 01, 2020	Addition	Disposal/ Adjustments	As at March 31, 2021	As at April 01, 2020	Recognised/ (Reversed)	Disposal/ Adjustments	As at March 31, 2021	As at March 31, 2021	As at March 31, 2020
	Freehold Land	1	-	-	1	-	-	-	-	-	-	-	-	1
Buildings	12	-	-	12	4	1	-	5	-	-	-	-	7	8
<b>Total</b>	<b>13</b>	<b>-</b>	<b>-</b>	<b>13</b>	<b>4</b>	<b>1</b>	<b>-</b>	<b>5</b>	<b>-</b>	<b>-</b>	<b>-</b>	<b>-</b>	<b>8</b>	<b>9</b>

(₹ in Crore)

	Year ended	
	31/03/2022	31/03/2021
(a) Amount recognised in profit and Loss for Investment Properties are as under:		
Rental income	3	3
Direct operating expenses (including repairs and maintenance) on properties generating rental income	-	(1)
Direct operating expenses (including repairs and maintenance) on properties not generating rental income	-	-

(b) The Company has no contractual obligations to purchase, construct or develop investment properties or for repairs, maintenance and enhancements. There is no restrictions on the realisability of investment properties or the remittance of income and proceeds of disposal on the Company.

(c) The fair value of the Company's investment properties as at March 31, 2022 and March 31, 2021 have been arrived at on the basis of valuation carried out at the respective dates by an external, independent valuers. Independent valuer who arrived at fair value as at March 31, 2022 is registered under Rule 2 of Companies (Registered Valuers and Valuation) Rules, 2017. However values as presented in March 31, 2021 were done by independent valuer who was not registered under above mentioned rule.

(d) The fair value measurement for all the investments properties has been categorised as Level 2 based on the inputs to the valuation technique used. Considering the type of the assets, market approach (sales comparable method) to estimate the fair value of the subject properties is adopted.

#### Fair Value of Investment Properties:

(₹ in Crore)

	As at	
	31/03/2022	31/03/2021
	Level 2	Level 2
Freehold Land	1	1
Buildings	50	48
	<b>51</b>	<b>49</b>

#### (e) Items of Investment Properties

Useful Life (Years)

Freehold Land	Infinite
Buildings	60

(f) Certain Investment Properties are given as security towards Non-Convertible debentures of ₹ 6,000 crore (gross) (as at 31/03/2021 ₹ 6,000 crore), refer note - 18A (a).



# Notes

forming part of the Standalone Financial Statements

## 4A Goodwill

Refer Note 1B (F) for accounting policy on Intangible Assets

	As at	
	31/03/2022	31/03/2021
Cost	4	-
Less: Accumulated Impairment	-	-
<b>Net Carrying amount of Goodwill</b>	<b>4</b>	<b>-</b>

- (i) Goodwill generated during acquisition of extrusion business of Kuppam unit. As a result of goodwill impairment test for the year ended 31/03/2022, no goodwill impairment was identified as the recoverable value of the CGUs to whom goodwill was allocated exceeded their respective carrying amount.
- (ii) Refer note 53 Business Combination for further details.

## 4B Intangible Assets and Intangible Assets under Development

Refer Note 1B (F) for accounting policy on Intangible Assets

Refer Note 1B (G) for accounting policy on Stripping cost

Refer Note 1B (I) for accounting policy on Impairment of Non-Current Assets

Refer Note 1B (S) for accounting policy on Borrowing cost

	As at	
	31/03/2022	31/03/2021
Cost	1,076	777
Less: Accumulated Amortization and Impairment	547	456
<b>Net Carrying amount of Intangible Assets</b>	<b>529</b>	<b>321</b>
<b>Intangible Assets under Development (IAUD) - (b)</b>	<b>8</b>	<b>122</b>

Particulars	ORIGINAL COST				ACCUMULATED AMORTIZATION				ACCUMULATED IMPAIRMENT				NET CARRYING AMOUNT		
	As at April 01, 2021	Addition	Addition due to acquisition *	Disposal/ Adjust-ments	As at March 31, 2022	As at April 01, 2021	Addition	Disposal/ Adjust-ments	As at March 31, 2022	As at April 01, 2021	Recognised/ (Reversed)	Disposal/ Adjust-ments	As at March 31, 2022	As at March 31, 2022	As at March 31, 2021
Mining rights	661	86	-	13	760	304	85	1	390	44	-	-	44	326	313
Technology and Software	116	179	8	(2)	301	108	7	(2)	113	-	-	-	-	188	8
Customer related Intangible Assets	-	-	15	-	15	-	-	-	-	-	-	-	-	15	-
<b>Total</b>	<b>777</b>	<b>265</b>	<b>23</b>	<b>11</b>	<b>1,076</b>	<b>412</b>	<b>92</b>	<b>(1)</b>	<b>503</b>	<b>44</b>	<b>-</b>	<b>-</b>	<b>44</b>	<b>529</b>	<b>321</b>

\* refer note 53 Business Combination

Particulars	ORIGINAL COST				ACCUMULATED AMORTIZATION				ACCUMULATED IMPAIRMENT				NET CARRYING AMOUNT		
	As at April 01, 2020	Addition	Addition due to acquisition	Disposal/ Adjust-ments	As at March 31, 2021	As at April 01, 2020	Addition	Disposal/ Adjust-ments	As at March 31, 2021	As at April 01, 2020	Recognised/ (Reversed)	Disposal/ Adjust-ments	As at March 31, 2021	As at March 31, 2021	As at March 31, 2020
Mining rights	568	58	-	35	661	261	41	2	304	-	44	-	44	313	307
Technology and Software	112	4	-	-	116	105	3	-	108	-	-	-	-	8	7
<b>Total</b>	<b>680</b>	<b>62</b>	<b>-</b>	<b>35</b>	<b>777</b>	<b>366</b>	<b>44</b>	<b>2</b>	<b>412</b>	<b>-</b>	<b>44</b>	<b>-</b>	<b>44</b>	<b>321</b>	<b>314</b>

- (a) Addition in Mining Rights includes ₹ 57 crores (as at 31/03/2021, ₹ 44 crore) and amortization expense includes ₹ 76 crore (as at 31/03/2021, ₹ 20 crore) towards stripping activity assets.
- (b) The Carrying amount of Intangible Asset under Development as at 31/03/2022 is ₹ 8 crore (as at 31/03/2021 was ₹ 122 crore). During the current year, the Company has capitalised its Enterprise Resource Planning System. The Company has tested the carrying value of Intangible Asset under Development for impairment as at reporting date.

Items of Intangible Assets	Useful Life (Years)
Mining rights	8-41
Technology and Software	3-10
Customer related Intangible assets	5

- (d) Remaining amortisation period of mining rights ranges between 4 -34 years.

- (e) Intangible asset under development (IAUD) ageing schedule as at 31/03/2022

Particulars	Amount in IAUD for a period of				Total
	Less than 1 year	1-2 years	2-3 years	More than 3 years	
Projects in progress	2	4	2	-	8
Projects temporarily suspended	-	-	-	-	-
<b>Total</b>	<b>2</b>	<b>4</b>	<b>2</b>	<b>-</b>	<b>8</b>

- Intangible asset under development (IAUD) ageing schedule as at 31/03/2021

Particulars	Amount in IAUD for a period of				Total
	Less than 1 year	1-2 years	2-3 years	More than 3 years	
Projects in progress	50	29	38	5	122
Projects temporarily suspended	-	-	-	-	-
<b>Total</b>	<b>50</b>	<b>29</b>	<b>38</b>	<b>5</b>	<b>122</b>

# Notes

forming part of the Standalone Financial Statements

- (f) During the current year no IAUD projects completion is overdue or has exceeded its cost compared to its original plan as at 31/03/2022.

IAUD completion schedule for projects, whose completion is overdue or has exceeded its cost compared to its original plan as at 31/03/2021 are given below.

Project name	Suspended Project Details (Yes/No)	To be completed in				Total
		Less than 1 year	1-2 years	2-3 years	More than 3 years	
Enterprise Resource Planning System (Project Ekayaan)*	No	116	-	-	-	116

\* Project is presented due to time overrun. There is no cost overrun in above project.

- (g) All Computer Software items in Intangible Assets (except of Mahan Aluminium, Aditya Aluminium, Kalwa Plants of the Company) are given as security towards Non-convertible debentures of ₹ 6,000 crore (gross) (as at 31/03/2021 ₹ 6,000 crore), refer note - 18A (a).
- (h) The useful life of Intangible assets are reviewed, and adjusted if appropriate, at the end of each reporting period.
- (i) During the current year, interest capitalised was ₹ 8 crore (31 March 2021: ₹ 6 crore), refer note 33 for further details.

## 5. Investment in Subsidiaries

(Fully paid-up unless otherwise stated)

Refer Note 1B (A) for accounting policy on Investment in subsidiaries

Investment in Equity Shares at Cost - (a) and (d)	Face Value Per Unit	Numbers as at		Value as at	
		31/03/2022	31/03/2021	31/03/2022	31/03/2021
<b>Unquoted</b>					
A V Minerals (Netherlands) N.V. - (b)	€ 541.05	2,376,838	2,376,838	9,778	10,175
Dahej Harbour & Infrastructure Limited	₹ 10	50,000,000	50,000,000	50	50
East Coast Bauxite Mining Company Pvt Limited	₹ 10	7,400	7,400	-	-
Hindalco Almex Aerospace Limited	₹ 10	172,115,744	172,115,744	83	83
Lucknow Finance Company Limited	₹ 10	9,902,500	9,902,500	10	10
Minerals & Minerals Limited	₹ 10	50,000	50,000	-	-
Renuka Investments & Finance Limited	₹ 10	34,250,000	9,250,000	34	9
Renukeshwar Investments & Finance Limited	₹ 10	4,795,000	4,795,000	5	5
Suvas Holdings Limited	₹ 10	22,149,714	22,149,714	22	22
Utkal Alumina International Limited	₹ 10	6,251,482,818	6,251,482,818	6,362	6,362
Kosala Livelihood and Social Foundation	₹ 10	1,600,000	100,000	1	-
				<b>16,345</b>	<b>16,716</b>
<b>Other Equity Investment - (c)</b> <b>(Fair Value of Financial Guarantee given for)</b>					
Utkal Alumina International Limited	NA	NA	NA	75	75
Suvas Holdings Limited	NA	NA	NA	-	-
A V Minerals (Netherlands) N.V.	NA	NA	NA	3	3
				<b>78</b>	<b>78</b>
				<b>16,423</b>	<b>16,794</b>

- (a) Aggregate carrying value of Investments in subsidiaries is ₹ 16,423 crore (as at 31/03/2021 ₹ 16,794). None of the subsidiaries are listed on any stock exchange in India or outside India and these investments are carried at cost. There is no accumulated impairment as at current or previous year end.
- (b) During the year, A V Minerals (Netherlands) N.V., a wholly owned subsidiary has remitted US\$ 75 Million (₹ 557 crore) to the Company towards return of capital by reducing nominal value of its shares (from € 567.83 to € 541.05 per share). The Company has accounted for the same as reduction in Company's carrying value of investment in the said subsidiary. Foreign exchange gain of ₹ 160 crore arising out of this transaction has been recognised under the (Gain)/ Loss on Foreign Currency Transactions (Net), refer note 37.
- (c) Financial guarantees given to subsidiaries were initially recognised at fair value will continue to be accounted as Other Equity Investment until the investment in subsidiaries are derecognised or impaired.
- (d) Refer Note - 43 Related Party Disclosure for information on principal place of business of the above Subsidiaries.

## 6. Investment in Associates and Joint Ventures

(Fully paid-up unless otherwise stated)

Refer Note 1B (B) for accounting policy on Investment in Associates

Refer Note 1B (A) for accounting policy on Investment in Joint Ventures

### A Investments in Associates

	Face Value Per Unit	Numbers as at		Value as at	
		31/03/2022	31/03/2021	31/03/2022	31/03/2021
<b>Investment in Equity Shares at FVTOCI - (a) and (c)</b>					
<b>Unquoted</b>					
Aditya Birla Science and Technology Company Private Limited	₹ 10	9,800,000	9,800,000	59	74
Aditya Birla Renewables Subsidiary Limited	₹ 10	6,895,200	6,895,200	47	54
Aditya Birla Renewables Solar Limited	₹ 10	8,307,000	130,000	48	-
<b>Total (A)</b>				<b>154</b>	<b>128</b>

### B Investments in Joint Ventures

Investment in Equity Shares at Cost - (a) and (c)

Unquoted

MNH Shakti Limited - (b)	₹ 10	5,265,000	12,765,000	5	13
Hydromine Global Minerals GMBH Limited	\$ 100	66,562	66,562	1	1
<b>Total (B)</b>				<b>6</b>	<b>14</b>
<b>Investment in Associates and Joint Ventures (A+B)</b>				<b>160</b>	<b>142</b>

- (a) Aggregate amount of investments is given below:

	(₹ in Crore)	
Aggregate cost of unquoted investments in Associates	25	17
Aggregate cost of unquoted investments in Joint Ventures	38	46
Impairment on unquoted investments in a Joint Venture	(32)	(32)

- (b) Pursuant to order received by MNH Shakti Limited from Hon'ble NCLT related its capital reduction, the Company has received amount of ₹ 8 crore during the year.
- (c) Refer Note - 43 Related Party Disclosure for information on principal place of business of the above Associates and Joint Ventures.

# Notes

forming part of the Standalone Financial Statements

## 7A. Other Investments, Non-Current

Refer Note 1B (P) for accounting policy on Financial Instruments

**Equity instruments at FVTOCI - (a)**  
(Fully paid-up unless otherwise stated)

	Face Value Per Unit	Numbers as at		Value as at	
		31/03/2022	31/03/2021	31/03/2022	31/03/2021
(₹ in Crore)					
<b>Quoted</b>					
Grasim Industries Limited	₹ 2	28,222,468	28,222,468	4,696	4,093
Ultra Tech Cement Limited	₹ 10	1,258,515	1,258,515	831	848
Aditya Birla Fashion & Retail Limited	₹ 10	50,239,794	44,982,142	1,518	905
Aditya Birla Fashion & Retail Limited (Partly paid up) - (b)	₹ 7.50	-	5,257,652	-	89
Vodafone Idea Limited	₹ 10	751,119,164	751,119,164	725	695
Aditya Birla Capital Limited	₹ 10	39,511,455	39,511,455	425	471
				<b>8,195</b>	<b>7,101</b>
<b>Unquoted</b>					
Sai Wardha Power Generation Limited	₹ 10	2,830,352	2,830,352	-	-
Birla International Limited	CHF 100	2,500	2,500	5	5
Bharuch Dahej Railway Company Limited	₹ 10	13,530,000	13,530,000	10	15
				<b>15</b>	<b>20</b>
<b>Debt Instruments at FVTOCI - (a)</b>					
<b>Quoted</b>					
<b>Government Securities - (c)</b>					
6.83% Government of India Bond, 2039		2,000,000	2,000,000	20	20
6.57% Government of India Bond, 2033		5,000,000	5,000,000	48	50
6.45% Government of India Bond, 2029		5,000,000	5,000,000	49	50
5.79% Government of India Bond, 2030		10,000,000	10,000,000	94	96
6.19% Government of India Bond, 2034		10,000,000	10,000,000	92	96
				<b>303</b>	<b>312</b>
<b>Debt Instruments at FVTPL - (a)</b>					
<b>Unquoted</b>					
<b>Mutual Funds</b>					
Investments in Debt Schemes of Mutual Funds				2	4
				<b>2</b>	<b>4</b>
				<b>8,515</b>	<b>7,437</b>
<b>(a) Aggregate amount of Quoted and Unquoted Investments, Market value of Quoted Investments are given below:</b>					
Aggregate Cost of Quoted Investments				1,484	1,470
Aggregate Market value of Quoted Investments				8,498	7,413
Aggregate Cost of Unquoted Investments				25	25
Aggregate amount of impairment in value of investments				3	3
Aggregate Carrying value of Quoted and Unquoted Investments				8,515	7,437

- (b) During the previous year, the Company had subscribed to the Rights issue of Aditya Birla Fashion & Retail Limited at ₹ 110 per share (Face value of ₹ 10 and Premium of ₹ 100). The Company had invested ₹ 43 crore (52,57,652 shares at ₹ 82.50 per share) in previous year and Final call of ₹ 14 crore (52,57,652 shares at ₹ 27.50 per share) has been paid during the current year.
- (c) Investments in Government Securities include ₹ 25 crore (as at 31/03/2021 ₹ 242 crore) being deposit as margin money with counter parties for derivative transactions.

## 7B. Investments, Current

Refer Note 1B (P) for accounting policy on Financial Instruments

	Face Value Per Unit	Numbers as at		Value as at	
		31/03/2022	31/03/2021	31/03/2022	31/03/2021
(₹ in Crore)					
<b>Equity instruments at FVTOCI - (b)</b> (Fully paid-up unless otherwise stated)					
<b>Quoted</b>					
National Aluminium Company Limited	₹ 5	-	18,385,327	-	99
				-	99
<b>Investments in Government securities at FVTOCI - (b)</b>					
<b>Quoted</b>					
7.95% GOI FCI Special Bonds, 2026	₹ 100	513,000	513,000	5	5
6.65% GOI FCI Special Bonds, 2023	₹ 100	2,096,600	2,096,600	21	22
7.00% GOI FCI Special Bonds, 2022	₹ 100	3,039,500	3,039,500	31	31
6.20% GOI FCI Special Bonds, 2022	₹ 100	1,432,100	1,432,100	15	15
				<b>72</b>	<b>73</b>
<b>Investments in Debentures and Bonds at FVTPL</b>					
<b>Investment in Other Entities - (b) and (c)</b>					
<b>Quoted</b>					
7.18% NCD of IRFC	₹ 1,000	1,192	1,192	-	-
8.10% NCD of IRFC	₹ 1,000	30,453	30,453	3	4
7.19% NCD NHB	₹ 1,000,000	50	50	5	5
8.12% NCD of REC Limited	₹ 1,000	43,523	43,523	5	5
7.93% NCD of REC Limited	₹ 1,000	-	56,615	-	6
7.22% NCD of REC Limited	₹ 1,000	5,130	5,130	1	1
7.38% NCD of REC Limited	₹ 1,000	10,321	10,321	1	1
8.11% NCD of REC Limited	₹ 1,000,000	250	250	26	27
8.27% NCD of REC Limited	₹ 1,000,000	250	250	26	27
7.18% NCD of PFC	₹ 1,000,000	500	500	52	51
7.19% NCD of PFC	₹ 1,000	9,565	9,565	1	1
7.36% NCD of PFC	₹ 1,000	25,187	25,187	3	3
8.20% NCD of PFC	₹ 1,000	-	36,862	-	4
8.30% NCD of PFC	₹ 1,000	10,163	10,163	1	1
7.07% HUDCO Bonds	₹ 1,000,000	50	50	6	5
7.34% HUDCO Bonds	₹ 1,000	100,000	100,000	10	11
7.51% HUDCO Bonds	₹ 1,000	50,000	50,000	6	6
7.28% NHAI Bonds	₹ 1,000,000	50	50	6	6
				<b>152</b>	<b>164</b>
<b>Investments in Mutual Funds at FVTPL - (a) and (b)</b>					
<b>Quoted</b>					
Investments in Debt Schemes of Mutual Funds				4,333	7,022
				<b>4,557</b>	<b>7,358</b>



## Notes

forming part of the Standalone Financial Statements

(a) Investments in Debt Schemes of Mutual Funds include ₹ 320 crore (as at 31/03/2021 ₹ 25 crore) being deposit as margin money with counter parties for derivative transactions.

(b) Aggregate amount of Quoted and Unquoted Investments, Market value of Quoted Investments are given below:

	(₹ in Crore)	
Aggregate Cost of Quoted Investments	4,425	7,193
Aggregate Market value of Quoted Investments	4,557	7,358
Aggregate Cost of Unquoted Investments	-	-
Aggregate amount of impairment in value of investments	-	-
Aggregate Carrying value of Quoted and Unquoted Investments	4,557	7,358

(c) NCD stands for Non Convertible Debentures

### 8. Loans

Refer Note 1B (P) for accounting policy on Financial Instruments  
(Unsecured, Considered Good unless otherwise stated)

	As at			
	31/03/2022		31/03/2021	
	Non-Current	Current	Non-Current	Current
Loan to Related Parties - (a)	38	167	4	45
Loan to Employees	7	5	7	4
Loan to Others	-	-	-	-
	45	172	11	49

(a) Refer note - 43 for balances with related parties.

(b) Disclosure on Loans or Advances in the nature of loans granted to promoters, directors, KMPs and the related parties, that are repayable on demand are as follows:

Type of Borrower *	Amount of loan or advance in the nature of loan outstanding		% to the total Loans and Advances in the nature of loans	
	31/03/2022	31/03/2021	31/03/2022	31/03/2021
	Promoters	-	-	-
Directors	-	-	-	-
KMPs	-	-	-	-
<b>Related Parties:</b>				
i) Aditya Birla Science & Technology Company Private Limited *	-	41	-	68%

\*There is no outstanding loan as at March 31, 2022 which is repayable on demand.

\* During the current and previous year there are no Loans or Advances in the nature of loans granted to promoters, directors, KMPs and the related parties, that are without specifying any terms or period of repayment.

### 9A. Other Financial Assets, Non-Current

Refer Note 1B (P) for accounting policy on Financial Instruments

(Unsecured, Considered Good unless otherwise stated)

	As at	
	31/03/2022	31/03/2021
Security Deposits - (a)	122	141
Earmarked balances with Banks - (b)	43	36
Deposit with Non-Banking Financial Company with initial maturity more than 12 months	60	-
Deposit with Others - (a)	7	11
	232	188

(a) Refer note - 43 for balances with related parties.

(b) Earmarked balances mainly includes balance in escrow accounts/ under lien with various authorities.

### 9B. Other Financial Assets, Current

Refer Note 1B (P) for accounting policy on Financial Instruments

(Unsecured, Considered Good unless otherwise stated)

	As at	
	31/03/2022	31/03/2021
Security Deposits	53	24
Deposits with Non-Banking Financial Company with initial maturity more than 3 months	915	150
Accrued Interest	44	22
Other Receivables		
Unsecured, Considered Good	144	58
Unsecured, Considered Doubtful	2	12
Less: Allowance for Doubtful Receivables	(2)	(12)
	1,156	254

### 10. Other Non Current and Current Assets

(Unsecured, Considered Good unless otherwise stated)

	As at			
	31/03/2022		31/03/2021	
	Non-Current	Current	Non-Current	Current
<b>Considered Good</b>				
Capital Advance	221	-	115	-
Advance to Employees	-	6	-	11
Deposit with Government and Other Authorities	-	30	-	37
Advance to Supplier for Goods and Services - (a)	2	1,158	89	604
Prepaid Expenses - (b)	6	72	5	55
Others - (c) and (d)	531	1,167	634	731
	760	2,433	843	1,438

# Notes

forming part of the Standalone Financial Statements

	(₹ in Crore)			
	As at			
	31/03/2022		31/03/2021	
	Non-Current	Current	Non-Current	Current
<b>Considered Doubtful</b>				
Advance to Supplier for Goods and Services	22	108	12	109
Others	-	11	-	11
Less: Allowance for Doubtful amount	(22)	(119)	(12)	(120)
<b>Unsecured, Considered Doubtful</b>	-	-	-	-
	<b>760</b>	<b>2,433</b>	<b>843</b>	<b>1,438</b>

- (a) Refer note - 43 for balances with related parties.
- (b) Prepaid Expenses include ₹ 24 crore (as at 31/03/2021 ₹ 12 crore) excess CSR spent carried forward to subsequent years. Refer note 56A for further details.
- (c) Mainly includes unutilised Indirect tax credits and claims receivables from Indirect Tax Authorities.
- (d) Includes ₹ 192 crore (Garepalma ₹ 74 crore and Kathautia ₹ 118 crore) [as at 31/03/2021 ₹ 192 crore (Garepalma ₹ 74 crore and Kathautia ₹ 118 crore)] towards appropriation of Performance Bank Guarantee by Nominated Authority (NA). Refer note - 52 for further details.

## 11. Inventories

Refer Note 1B (M) for accounting policy on Inventories

	(₹ in Crore)					
	As at 31/03/2022			As at 31/03/2021		
	In Hand	In Transit	Total	In Hand	In Transit	Total
Raw Materials	3,061	5,529	8,590	2,010	5,120	7,130
Work-in-Progress	8,211	57	8,268	6,395	33	6,428
Finished Goods	1,832	248	2,080	1,288	160	1,448
Stock-in-Trade	884	-	884	4	-	4
Stores and Spares	699	16	715	578	53	631
Coal and Fuel	402	9	411	339	9	348
	<b>15,089</b>	<b>5,859</b>	<b>20,948</b>	<b>10,614</b>	<b>5,375</b>	<b>15,989</b>

- (a) The Company has extended fair value hedge accounting on its inventory which forms part of Work-in-Progress and Finished Goods, Fair value hedges are mainly used to hedge the exposure to change in fair value of commodity price risks. The fair value adjustment remains part of the carrying value of inventory and is taken to profit and loss when the inventory is either sold or consumed, refer note - 49A and 49H.
- (b) For Inventories hypothecated against secure short-term borrowings, refer note - 18B (a).
- (c) Write downs of inventories (net of reversal) to net realizable value related to raw materials, work-in-progress and finished goods amounted to ₹ 586 crore (as at 31/03/2021 ₹ 349 crore). These were recognized as expense during the year and included in 'cost of raw material consumed' and 'change in value of inventories of work-in-progress and finished goods' in statement of Profit and Loss.
- (d) Inventories in hand include bulk materials of Coal, Bauxite and Copper Concentrate lying at yards, mines, plants and precious metals of Gold and Silver lying at Copper smelter and refinery aggregating to ₹ 4,302 crore (as at 31/03/2021 ₹ 3,179 crore).

## 12. Trade Receivables

Refer Note 1B (N) for accounting policy on Trade receivable

	(₹ in Crore)	
	As at	
	31/03/2022	31/03/2021
Trade Receivables:		
Secured, Considered Good	3	4
Unsecured, Considered Good	2,671	1,600
Unsecured, Credit Impaired	34	30
	<b>2,708</b>	<b>1,634</b>
Less: Loss Allowances - (d)	(37)	(32)
	<b>2,671</b>	<b>1,602</b>

### (a) Trade Receivable ageing schedule as at 31 March 2022

Particulars	Unbilled	Not due	Outstanding for following periods from due date of receipt					Total
			Less than 6 months	6 months - 1 year	1-2 years	2-3 yrs.	More than 3 yrs.	
(i) Undisputed – considered good	-	2,439	219	9	1	-	6	2,674
(ii) Undisputed – which have significant increase in credit risk	-	-	-	-	-	-	1	1
(iii) Undisputed – credit impaired	-	-	-	-	-	-	9	9
(iv) Disputed – considered good	-	-	-	-	-	-	-	-
(v) Disputed – which have significant increase in credit risk	-	-	-	-	-	3	-	3
(vi) Disputed – credit impaired	-	-	-	-	-	-	21	21
<b>Total</b>	<b>-</b>	<b>2,439</b>	<b>219</b>	<b>9</b>	<b>1</b>	<b>3</b>	<b>37</b>	<b>2,708</b>
Less: Loss Allowances								(37)
<b>Net Trade Receivables</b>								<b>2,671</b>

### Trade Receivable ageing schedule as at 31 March 2021

Particulars	Unbilled	Not due	Outstanding for following periods from due date of receipt					Total
			Less than 6 months	6 months - 1 year	1-2 years	2-3 yrs.	More than 3 yrs.	
(i) Undisputed – considered good	-	1,268	324	4	2	-	6	1,604
(ii) Undisputed – which have significant increase in credit risk	-	-	-	-	-	-	-	-
(iii) Undisputed – credit impaired	-	-	-	-	0	-	9	9
(iv) Disputed – considered good	-	-	-	-	-	-	-	-
(v) Disputed – which have significant increase in credit risk	-	-	-	-	-	-	-	-
(vi) Disputed – credit impaired	-	-	-	-	-	-	21	21
<b>Total</b>	<b>-</b>	<b>1,268</b>	<b>324</b>	<b>4</b>	<b>2</b>	<b>-</b>	<b>36</b>	<b>1,634</b>
Less: Loss Allowances								(32)
<b>Net Trade Receivables</b>								<b>1,602</b>

# Notes

forming part of the Standalone Financial Statements

- (b) For trade receivables hypothecated against borrowings, refer note - 18B (a)
- (c) No trade or other receivable are due from directors or other officers of the Company either severally or jointly with any other person. Further, no trade or other receivable are due from firms or private companies respectively in which any director is a partner, or director or member.
- (d) Loss allowances includes provision of ₹ 3 crore (31/03/2021: ₹ 2 crore) made on account of expected credit loss on Trade Receivables, refer note - 48 (C)
- (e) Refer note - 43 for balances with related parties.

## 13. Cash and Cash Equivalents

Refer Note 1B (R) for accounting policy on Cash and cash equivalents

	(₹ in Crore)	
	As at	
	31/03/2022	31/03/2021
Cash in Hand	-	-
Cheques and Drafts in Hand - (a)	14	8
<b>Balances with Banks</b>		
Current Accounts	281	254
Deposit with Initial maturity of less than three months	2,500	-
Short term liquid Investments in Mutual Funds	610	741
	<b>3,405</b>	<b>1,003</b>

- (a) Includes Nil (as at 31/03/2021 ₹ 3 crore) remittance in transit.
- (b) There is no restriction with regard to cash and cash equivalents at the end of reporting period and prior periods.

## 14. Bank Balances other than Cash and Cash Equivalents

Refer Note 1B (P) for accounting policy on Financial Instruments

	(₹ in Crore)	
	As at	
	31/03/2022	31/03/2021
<b>Balances with Banks</b>		
Earmarked Balances - (a)	14	13
Deposits with Initial Maturity more than three months	3,001	3
	<b>3,015</b>	<b>16</b>

- (a) Includes unclaimed dividend of ₹ 5 crore( as at 31/03/2021 ₹ 4 crore)

## 15. Non-Current Assets classified as Held For Sale

Refer Note 1B (H) for accounting policy on Non-current assets (or disposal groups) held for sale

	(₹ in Crore)	
	As at	
	31/03/2022	31/03/2021
Non-Current assets classified as Held for Sale	3	4
	<b>3</b>	<b>4</b>
<b>(a) Assets held for sale</b>		
Land and Building	1	1
Plant and Machinery	2	3
<b>Total</b>	<b>3</b>	<b>4</b>

- (b) The fair value of the assets held for sale approximates the carrying value.
- (c) The Company is in the process of disposing the remaining assets.

## 16. Equity Share Capital

	(₹ in Crore)	
	As at	
	31/03/2022	31/03/2021
<b>Authorised</b>		
2,500,000,000 (as at 31/03/2021: 2,500,000,000) Equity Shares of ₹ 1/- each	250	250
25,000,000 (as at 31/03/2021: 25,000,000) Redeemable Cumulative Preference Shares of ₹ 2/- each	5	5
	255	255
<b>Issued</b>		
2,247,726,370 (as at 31/03/2021: 2,247,237,893) Equity Shares of ₹ 1/- each - (a)	225	225
	225	225
<b>Subscribed and Paid-up</b>		
2,247,718,973 (as at 31/03/2021: 2,247,230,496) Equity Shares of ₹ 1/- each fully paid-up	225	225
Less: Face Value of 546,249 (as at 31/03/2021: 546,249) Equity Shares forfeited	-	-
Add: Forfeited Shares (Amount originally Paid up)	-	-
	225	225
Less: Treasury Shares		
16,316,130 (as at 31/03/2021: 16,316,130) Equity Shares. - (b)	(2)	(2)
7,064,997 (as at 31/03/2021: 5,824,965) Equity Shares - (c)	(1)	(1)
	<b>222</b>	<b>222</b>

- (a) Issued Equity Capital as at 31/03/2022 includes 7,397 Equity Shares (as at 31/03/2021 7,397 Equity Shares) of ₹ 1/- each issued on Rights basis kept in abeyance due to legal case pending.
- (b) Treasury shares include shares held by Trident Trust which represents 16,316,130 (as at 31/03/2021: 16,316,130) equity shares of ₹ 1/- each fully paid-up of the Company issued, pursuant to a Scheme of Arrangements approved by the Hon'ble High Courts of Mumbai and of Allahabad, vide their Orders dated 31st October, 2002, and 18th November, 2002, respectively, to the Trident Trust, created wholly for the benefit of the Company and is being managed by trustees appointed by it. The tenure of the Trust is up to January 23, 2024.



# Notes

forming part of the Standalone Financial Statements

(c) Treasury shares include shares held by Hindalco Employee Welfare Trust (ESOP Trust) which represents 7,064,997 equity shares (as at 31/03/2021 5,824,965 Equity Shares) of ₹ 1/- each fully paid-up of the Company. The Trust buys shares of the Company from the market, for giving shares to employees pursuant to the Employees Stock Option Scheme, 2018. Refer note 17 (A) (viii) for further details.

(d) Reconciliation of shares outstanding at the beginning and at the end of the reporting period:

	As at			
	31/03/2022		31/03/2021	
	Numbers	₹ in Crore	Numbers	₹ in Crore
Equity shares outstanding at the beginning of the year	2,224,543,152	222	2,224,020,885	222
Equity shares allotted pursuant to exercise of Employee Stock Option Scheme (ESOS)	488,477	-	461,560	-
Equity shares purchased by Hindalco Employee Welfare Trust from market pursuant to ESOS	(2,119,000)	-	-	-
Equity shares allotted pursuant to exercise of ESOS through Hindalco Employee Welfare Trust	878,968	-	60,707	-
Equity shares outstanding at the end of the year	2,223,791,597	222	2,224,543,152	222

(e) Rights, preferences and restrictions attached to Equity Shares:

The Company has one class of equity shares having a par value of ₹ 1/- per share. Each shareholder is eligible for one vote per share held. The dividend proposed by the Board of Directors is subject to the approval of the shareholders in the ensuing Annual General Meeting, except in case of interim dividend. In the event of liquidation, the equity shareholders are eligible to receive the remaining assets of the Company after distribution of all preferential amounts, in proportion to their shareholding.

(f) Details of shareholders holding more than 5% Equity Shares in the Company on reporting date:

	As at			
	31/03/2022		31/03/2021	
	Number of Shares Held	Percentage of Holding *	Number of Shares Held	Percentage of Holding *
IGH Holdings Private Limited	350,088,487	15.58	349,963,487	15.58%
Birla Group Holdings Private Limited	228,292,308	10.16	228,292,308	10.16%
Life Insurance Corporation of India and its Associates	189,588,459	8.44	203,135,624	9.04%
Morgan Guaranty Trust Company of New York	98,270,986	4.37	151,010,943	6.72%

\* Percentage have been calculated on the basis of total number of shares outstanding (before adjusting shares held by Trident Trust and ESOP Trust, refer footnote (b) and (c) above.

(g) Shares held by promoters at the end of the year and Movement

Promoter's Name <sup>5</sup>	No. of Shares at 31/03/2022	Percentage of total shares *	No. of Shares at 31/03/2021	Percentage of total shares *	% Change during the Year
Kumar Mangalam Birla	901,635	0.04	901,635	0.04	-
Birla Group Holdings Private Limited	228,292,308	10.16	228,292,308	10.16	-
<b>Total</b>	<b>229,193,943</b>		<b>229,193,943</b>		

<sup>5</sup> Promoter here means promoter as defined in Section 2(69) of the Companies Act, 2013.

\* Percentage have been calculated on the basis of total number of shares outstanding (before adjusting shares held by Trident Trust and ESOP Trust, refer footnote (b) and (c) above.

(h) Shares reserved for issue under options:

The Company has reserved equity shares for issue under the Employee Stock Option Schemes, refer note 42 - Employee Share-based Payments for details of Employee Stock Option Schemes.

(i) The Company during the preceding 5 years:

- Has not allotted shares pursuant to contracts without payment received in cash.
- Has not issued shares by way of bonus shares.
- Has not bought back any shares.

(j) The Board of Directors of the Company has recommended final dividend of ₹ 4 per share aggregating to ₹ 899 crore for the year ended 31/03/2022 which has not been recognised in the financial statement.

## 17. Other Equity

	As at	
	31/03/2022	31/03/2021
	(₹ in Crore)	
<b>Share Application Money pending Allotment</b>	-	-
<b>Reserves and Surplus</b>		
Capital Reserve	145	145
Capital Redemption Reserve	102	102
Business Reconstruction Reserve	7,715	7,715
Securities Premium	8,233	8,224
Debenture Redemption Reserve	1,500	1,350
Employee Stock Options	76	55
Treasury Shares held by ESOP Trust	(199)	(129)
General Reserve	21,354	21,354
Retained Earning	10,252	5,494
	<b>49,178</b>	<b>44,310</b>
<b>Other Reserves</b>		
Gain/ (Loss) on Equity Instruments FVTOCI	6,923	6,117
Gain/ (Loss) on Debt Instruments FVTOCI	(5)	1
Effective portion of Cash Flow Hedge	(1,851)	(596)
Cost of Hedging Reserve	(39)	10
	<b>5,028</b>	<b>5,532</b>
	<b>54,206</b>	<b>49,842</b>

(A) Brief Descriptions of items of Other Equity are given below:

(i) **Share Application Money pending Allotment:**

Share application money pending allotment represents amount received from employees who has exercised employee stock options for which shares are pending allotment as on balance sheet date.

(ii) **Capital Reserve:**

The Company has created capital reserve pursuant to past mergers and acquisitions.

# Notes

forming part of the Standalone Financial Statements

**(iii) Capital Redemption Reserve:**

The Company has created capital redemption reserve as per the requirement of the Companies Act.

**(iv) Business Reconstruction Reserve:**

The Company had formulated a scheme of financial restructuring under sections 391 to 394 of the Companies Act 1956 ("the Scheme") between the Company and its equity shareholders approved by the High Court of judicature of Bombay to deal with various costs associated with its organic and inorganic growth plan. Pursuant to this, a separate reserve account titled as Business Reconstruction Reserve ("BRR") was created during the year 2008-09 by transferring balance standing to the credit of Securities Premium Account of the Company for adjustment of certain expenses as prescribed in the Scheme.

**(v) Securities Premium:**

Securities premium reserve is used to record the premium on issue of shares. The reserve is utilized in accordance with the provision of the Act.

**(vi) Debenture Redemption Reserve:**

The Company is required to create a debenture redemption reserve out of the profits which is available for payment of dividend, for the purpose of redemption of debentures.

**(vii) Employee Stock Options:**

The employee stock option account is used to recognize the grant date fair value of options /RSUs issued to employees under stock option schemes.

**(viii) Treasury Shares held by ESOP Trust**

The Company has created a trust, namely "Hindalco Employee Welfare Trust"(ESOP Trust) for providing share-based payments to its employees (including its Subsidiaries' employees). The Company uses this Trust as a vehicle for distributing shares to employees covered under Scheme. The Trust buys shares of the Company from the market, for giving shares to employees under the Employees Stock Option Scheme, 2018.

Shares held by Trust are treated as Treasury shares. Equity instruments that are reacquired (Treasury shares) are recognised at cost and deducted from equity. No gain or loss is recognised in Statement of Profit and Loss on purchase, sale, issue or cancellation of Equity instruments. Share options whenever exercised, would be utilised from such treasury shares, refer note 42.

**(ix) General Reserve:**

The Company has created this reserve by transferring certain amount out of the profit at the time of distribution of dividend in the past.

**(x) Retained Earning**

Amount of retained earnings represents accumulated profit and losses of the Company as on reporting date. Such profits and losses are after adjustment of payment of dividend, transfer to any reserves as statutorily required and adjustment for realised gain/loss on derecognition of equity instruments measured at FVTOCI. Actuarial Gain/ Loss arising out of Actuarial valuation is immediately transferred to Retained Earning.

**(xi) Other Reserves**

**a) Gain/ (Loss) on equity and debt instruments accounted as FVTOCI**

The Company has elected to recognize changes in the fair value of certain investments in other comprehensive income. These changes are accumulated within the FVTOCI equity investments reserve and FVTOCI debt investment reserve within equity.

**b) Effective portion of Cash Flow Hedge:**

The Company uses hedging instruments as part of its risk management policy for commodity and foreign currency risk as described in note 49. The Cash Flow hedging reserve is used to recognise the effective portion of gain or loss on designated hedging relationship, refer note 49 (E) and 49 (F).

**c) Cost of Hedging Reserve:**

The Company designates the spot component of some of its derivative instruments in fair value hedge relationship and cash flow hedge relationship. The Company defers changes in the forward element of such instruments in the cost of hedging reserve. For fair value hedge forward points at inception is amortized on a straight line basis from the OCI based on the remaining life of trade. For cash flow hedge the deferred cost of hedging are included in the initial cost of the related hedged items when it is recognized or reclassified to the statement of profit and loss when the hedged item effects the statement of profit and loss. The Company designates the intrinsic value of option contracts whereas the time value of option contracts is included in the cost of hedging reserve, refer note 49 (E) and 49 (F).

**(B) Movement of each item of other equity is presented in Statement of Changes in Equity (SOCIE).**

**18A.Borrowings, Non-Current**

Refer Note 1B (P) for accounting policy on Financial Instruments

Particulars	As at					
	31/03/2022			31/03/2021		
	Non-Current Portion	Current Maturities #	Total	Non-Current Portion	Current Maturities #	Total
<b>Secured</b>						
Debentures						
Secured Non-Convertible Debentures - (a)	-	5,999	5,999	5,997	-	5,997
Term Loans						
From Banks						
Rupee Term Loans - (b)	11,668	8	11,676	9,177	8	9,185
Foreign Currency Term Loans - (c)	-	-	-	-	457	457
	<b>11,668</b>	<b>6,007</b>	<b>17,675</b>	<b>15,174</b>	<b>465</b>	<b>15,639</b>

# Current maturities of non-current borrowings have been disclosed under "Borrowings, Current", refer note 18B.

**(a) Debentures comprise of following:**

	As at				
	31/03/2022		31/03/2021		Redemption Date
	Gross Amount	Carrying Value	Gross Amount	Carrying Value	
30,000 9.55% Redeemable Non-Convertible Debentures of ₹ 10 lakhs each	3,000	3,000	3,000	2,999	25/04/2022
15,000 9.55% Redeemable Non-Convertible Debentures of ₹ 10 lakhs each	1,500	1,500	1,500	1,499	27/06/2022
15,000 9.60% Redeemable Non-Convertible Debentures of ₹ 10 lakhs each	1,500	1,499	1,500	1,499	02/08/2022
	<b>6,000</b>	<b>5,999</b>	<b>6,000</b>	<b>5,997</b>	

All the above Debentures are secured by movable items of Property, Plant and Equipment, both present and future (except movable assets of Mahan Aluminium plant, Aditya Aluminium plant, Kalwa plant, Current Assets of the Company) and certain immovable properties of the Company, refer note - 2A (c) (iii).

## Notes

forming part of the Standalone Financial Statements

### (b) Rupee term loan from banks comprise of following:

(₹ in Crore)

	Note	Rate of Interest <sup>^</sup>	As at				End of tenure
			31/03/2022		31/03/2021		
			Gross Amount	Carrying Value	Gross Amount	Carrying Value	
Axis Bank		Repo Rate + 275 bps	619	602	619	610	31/03/2030
State Bank of India		MCLR 3 Month + 10 bps	2,239	2,216	2,239	2,227	31/03/2030
ICICI Bank		Repo Rate + 275 bps *	76	75	84	84	31/03/2030
<b>Rupee Term Loans : (A)</b>	(I)		<b>2,934</b>	<b>2,893</b>	<b>2,942</b>	<b>2,921</b>	
State Bank of India		MCLR 3 Month + 10 bps	4,672	4,665	4,672	4,657	01/09/2030
PNB Bank		MCLR 1 Month + 5 bps	256	255	256	255	01/09/2030
Axis Bank		Repo Rate + 275 bps	1,371	1,363	1,371	1,352	01/09/2030
<b>Rupee Term Loans : (B)</b>	(II)		<b>6,299</b>	<b>6,283</b>	<b>6,299</b>	<b>6,264</b>	
SBI Bank		MCLR 3 Month + 15 bps	2,500	2,500	-	-	31/12/2031
<b>Rupee Term Loans : (C)</b>	(III)		<b>2,500</b>	<b>2,500</b>	<b>-</b>	<b>-</b>	
<b>Total Rupee Term Loans (A)+(B)+(C)</b>			<b>11,733</b>	<b>11,676</b>	<b>9,241</b>	<b>9,185</b>	

\* Benchmark changed w.e.f. February 2022. Previous benchmark was T-bill.

<sup>^</sup> Definition of abbreviation used

(i) 100 basis points (bps) is equal to 1%

(ii) Repo rate is the rate at which RBI lends funds to commercial banks.

(iii) Marginal Cost of funds based Lending Rate (MCLR) is a tenor-linked internal benchmark rate of respective bank

(iv) Treasury Bill (T-bill) means the rate of interest published by the Financial Benchmarks India Pvt. Ltd. ("FBIL").

- (I) The term loans from banks of ₹ 2,934 crore (gross) (31/03/2021: ₹ 2,942 crore) are secured by a first ranking charge/ mortgage/ security interest in respect of all the movable and immovable items of Property, Plant and Equipment of Mahan Aluminium plant, both present and future. ₹ 2,858 crore (gross) (31/03/2021: ₹ 2,858 crore) is to be repaid in 16 quarterly instalments commencing from June 2026. Balance ₹ 76 crore (gross) (31/03/2021: ₹ 84 crore) is to be repaid in 32 quarterly instalments (31/03/2021: 36 quarterly instalments) as per original repayment schedule effective June 2020, refer note - 2A(c) (i).
- (II) The term loan of ₹ 6,299 crore (gross) (31/03/2021: ₹ 6,299 crore) is secured by a first ranking charge/ mortgage/security interest in respect of all the movable and immovable items of Property, Plant and Equipment of Aditya Aluminium plant both present and future. ₹ 6,299 crore (gross) (31/03/2021: ₹ 6,299 crore) is to be repaid in 26 quarterly instalments commencing from May 2024, refer note - 2A(c) (ii).
- (III) The term loan of ₹ 2,500 crore (gross) is secured by a first ranking charge/ mortgage/security interest in respect of all the movable and immovable items of Property, Plant and Equipment of Mahan Aluminium plant both present and future. ₹ 2,500 crore (gross) is to be repaid in 34 quarterly instalments commencing from September 2023, refer note - 2A(c) (i).

### (c) Foreign currency term loans from bank comprise of following:

(₹ in Crore)

	Currency	Rate of Interest	As at				End of tenure
			31/03/2022		31/03/2021		
			Gross Amount	Carrying Value	Gross Amount	Carrying Value	
Bank of Tokyo Mitsubishi (BTMU)	USD	LIBOR 3M + 135 bps	-	-	293	291	31/03/2022
Bank of Tokyo Mitsubishi (BTMU)	USD	LIBOR 3M + 135 bps	-	-	167	166	30/06/2022
<b>Foreign Currency Term Loans : Mahan Unit</b>			<b>-</b>	<b>-</b>	<b>460</b>	<b>457</b>	

Foreign currency term loan pertained to loan from Bank of Tokyo Mitsubishi (BTMU) of USD 40 Millions and USD 22.79 Millions. BTMU loan was secured by a pari-passu first charge on all movable Property, Plant and Equipment of Mahan Aluminium plant, both present and future, refer note - 2A (c) (i). The Company has prepaid both the loans in April 2021.

### (d) Changes in liabilities arising from financing activities

(₹ in Crore)

Particulars	Other Assets	Liabilities from Financing Activities				Total
	Cash and Cash Equivalents	Non Current Borrowings	Current Borrowings	Lease Liabilities	Supplier's Credit	
<b>Balance as at April 01, 2020 #</b>	<b>3,231</b>	<b>16,199</b>	<b>7,419</b>	<b>317</b>	<b>-</b>	<b>27,166</b>
Additions	-	-	-	17	-	17
Cash Flows (Net)	(2,228)	(6)	(2,829)	(69)	255	(4,877)
Foreign Exchange Adjustments	-	(14)	(265)	-	-	(279)
Fair Value Changes, refer note 27 (b)	-	(56)	-	-	-	(56)
Debt Issuance Costs and Amortisation	-	49	-	-	-	49
Interest Expense **	-	1,232	140	25	-	1,397
Interest Paid **	-	(1,242)	(171)	(22)	-	(1,435)
Other Changes/ Reclassification - Modification/ Reassessment	-	-	-	43	-	43
<b>Balance as at March 31, 2021 #</b>	<b>1,003</b>	<b>16,162</b>	<b>4,294</b>	<b>311</b>	<b>255</b>	<b>22,025</b>
Additions	-	-	-	131	-	131
Cash Flows (Net)	2,402	2,032	(2,923)	(71)	2,161	3,601
Foreign Exchange Adjustments	-	1	36	-	40	77
Fair Value Changes, refer note 27 (b)	-	(53)	-	-	-	(53)
Debt Issuance Costs and Amortisation	-	57	-	-	-	57
Interest Expense **	-	1,201	63	26	8	1,298
Interest Paid **	-	(1,198)	(61)	(23)	(8)	(1,290)
Other Changes/ Reclassification - Modification/ Reassessment	-	-	-	(32)	-	(32)
<b>Balance as at March 31, 2022 #</b>	<b>3,405</b>	<b>18,202</b>	<b>1,409</b>	<b>342</b>	<b>2,456</b>	<b>25,814</b>

# Borrowings include Interest accrued on borrowings and current maturities of related borrowings.

\*\* Interest expense and interest paid relates to borrowings and lease liabilities before interest capitalisation.



# Notes

forming part of the Standalone Financial Statements

## 18B. Borrowings, Current

Refer Note 1B (P) for accounting policy on Financial Instruments

	As at	
	31/03/2022	
	31/03/2022	31/03/2021
<b>Secured</b>		
Rupee Loans from Banks - (a)	3	5
	<b>3</b>	<b>5</b>
<b>Unsecured</b>		
Rupee Loans from Banks - (c)	-	40
Foreign currency Loans from Indian Banks - (b)	1,401	2,607
Foreign currency Loans from Foreign Banks - (b)	-	1,638
Other Borrowings	-	-
	1,401	4,285
<b>Current maturities of Long-Term Borrowings</b>	<b>6,007</b>	<b>465</b>
	<b>7,411</b>	<b>4,755</b>

- (a) Working Capital loan for Aluminium business, granted under the Consortium Lending Arrangement, are secured by a first pari-passu charge on entire stocks of raw materials, work-in-process, finished goods, consumable stores and spares and also book debts pertaining to the Company's Aluminium business, both present and future. Working Capital loan for the Copper business is secured by a first pari passu charge on stocks of raw materials, work-in-process, finished goods and consumable stores and spares and also book debts and other movable assets of Copper business, both present and future, refer note 11 (b) and 12 (b).
- (b) Foreign currency loans from Indian Banks and Offshore branch of Foreign banks are mainly in nature of Buyers credit which has been availed for Copper business to meet its working capital requirement mostly to settle import payments of copper concentrate and certain other raw materials. Refer note 49C on non-derivative financial instruments used as hedging instruments.
- (c) Rupee Loans from Banks represents loan taken to meet the Company's working capital requirements.
- (d) Loan Details are as follows:

	Currency	Rate of Interest #	Terms of Repayment #	As at	
				Carrying amount	
				31/03/2022	31/03/2021
<b>Secured</b>					
Rupee Loans from Banks @	INR	-	Payable on demand	3	5
<b>Unsecured</b>					
Rupee Loans from Banks	INR	-	-	-	40
Foreign currency Loans from Indian Banks	USD	6M SOFR*	Payable from Apr 22- May 22	1,401	2,607
Foreign currency Loans from Foreign Banks	USD	-	-	-	1,638
				<b>1,404</b>	<b>4,290</b>

# Rate of Interest and Terms of repayment pertains to borrowing outstanding as at 31/03/2022.

@ This consist of Cash Credit (CC) balance.

\* SOFR stands for Secured Overnight Financing Rate.

## 19. Supplier's Credit

	As at			
	31/03/2022		31/03/2021	
	Non-Current	Current	Non-Current	Current
Supplier's Credit (a)	-	2,456	-	255
	-	<b>2,456</b>	-	<b>255</b>

- (a) Supplier's credit represents the extended interest bearing credit offered by the supplier which is secured against Usance Letter of Credit (LC). Under this arrangement, the supplier is eligible to receive payment from negotiating bank prior to the expiry of the extended credit period. The interest for the extended credit period payable to the bank on maturity of the LC has been presented under Finance Cost.

## 20. Trade Payables

Refer Note 1B (O) for accounting policy on Trade and other payables

	As at			
	31/03/2022		31/03/2021	
	Non-Current	Current	Non-Current	Current
Micro and Small Enterprises - (b)	-	96	-	52
Other than Micro and Small Enterprises - (c) and (d)	-	10,919	-	8,748
	-	<b>11,015</b>	-	<b>8,800</b>

### (a) Trade Payables ageing schedule as at 31 March 2022

S. Particulars No.	Unbilled	Not due	Outstanding for following periods from due date of payment				Total
			Less than 1 year	1-2 years	2-3 years	More than 3 years	
(i) MSME	14	31	44	3	3	1	96
(ii) Others	865	2,351	7,516	26	22	52	10,832
(iii) Disputed dues- MSME	-	-	-	-	-	-	-
(iv) Disputed dues- Others	-	-	21	22	44	-	87
<b>Total</b>	<b>879</b>	<b>2,382</b>	<b>7,581</b>	<b>51</b>	<b>69</b>	<b>53</b>	<b>11,015</b>

### Trade Payables ageing schedule as at 31 March 2021

S. Particulars No.	Unbilled	Not due	Outstanding for following periods from due date of payment				Total
			Less than 1 year	1-2 years	2-3 years	More than 3 years	
(i) MSME	3	12	31	5	-	1	52
(ii) Others	548	1,659	6,302	24	10	70	8,613
(iii) Disputed dues- MSME	-	-	-	-	-	-	-
(iv) Disputed dues- Others	-	-	24	53	12	46	135
<b>Total</b>	<b>551</b>	<b>1,671</b>	<b>6,357</b>	<b>82</b>	<b>22</b>	<b>117</b>	<b>8,800</b>

## Notes

forming part of the Standalone Financial Statements

- (b) Information related to Micro and Small Enterprises, as per the Micro, Small and Medium Enterprises Development Act, 2006 (MSME Development Act), are given below. The information given below have been determined to the extent such enterprises have been identified on the basis of information available with the Company:

(₹ in Crore)

	As at	
	31/03/2022	31/03/2021
(i) Principal amount outstanding	94	51
(ii) Interest on Principal amount due thereon	-	-
(iii) Interest and Principal amount paid beyond appointment day	50	46
(iv) The amount of interest due and payable for the period of delay in making payment (which have been paid but beyond the appointed date during the year) but without adding the amount of interest specified under MSME Development Act.	2	1
(v) The amount of interest accrued and remaining unpaid at the end of the year.	2	1
(vi) The amount of further interest remaining due and payable even in the succeeding years, until such date when the interest dues as above are actually paid to the Small enterprise, for the purpose of disallowance as a deductible expenditure under Section 23 of MSME Development Act.	2	1

- (c) Refer note - 43 for balances with related parties.

- (d) Refer note 49 (A) on non-derivative financial instruments used as hedging instruments.

### 21A. Other Financial Liabilities, Non-Current

Refer Note 1B (P) for accounting policy on Financial Instruments

(₹ in Crore)

	As at	
	31/03/2022	31/03/2021
Liability for Capital Expenditure	8	4
Retention Amount Payable	2	6
Security and Other deposits	3	-
	<b>13</b>	<b>10</b>

### 21B. Other Financial Liabilities, Current

Refer Note 1B (P) for accounting policy on Financial Instruments

(₹ in Crore)

	As at	
	31/03/2022	31/03/2021
Interest Accrued but not due	532	527
Liability for Capital Expenditure	304	281
Retention Amount Payable	118	94
Security and Other deposits	41	31
Investor Education and Protection Fund		
Unclaimed Dividends - (a)	5	4
Temporary Book Overdraft	-	-
	<b>1,000</b>	<b>937</b>

- (a) This amount do not include any amount due and outstanding, to be credited to Investor Education and Protection Fund except ₹ 0.09 crore (as at 31/03/2021 ₹ 0.09 crore) which is held in abeyance due to legal cases pending.

## 22. Provisions

Refer Note 1B (K) for accounting policy on Provisions and contingencies

Refer Note 1B (U) for accounting policy on Employee Benefits

(₹ in Crore)

	As at					
	31/03/2022			31/03/2021		
	Non-Current	Current	Total	Non-Current	Current	Total
<b>Employee Benefits Provisions, (refer note 31) - A</b>	<b>142</b>	<b>275</b>	<b>417</b>	<b>174</b>	<b>268</b>	<b>442</b>
<b>Other Provisions - B</b>						
Asset Retirement Obligations	110	-	110	99	-	99
Environmental Liability	83	179	262	9	54	63
Enterprise Social Commitment	138	10	148	139	9	148
Legal Cases	-	383	383	-	331	331
Renewable Power Obligation	-	148	148	-	156	156
Miscellaneous Provisions	1	11	12	-	13	13
	<b>332</b>	<b>731</b>	<b>1,063</b>	<b>247</b>	<b>563</b>	<b>810</b>
<b>Total (A+B)</b>	<b>474</b>	<b>1,006</b>	<b>1,480</b>	<b>421</b>	<b>831</b>	<b>1,252</b>

- (a) The details of provisions movement are as under:

(₹ in Crore)

Particulars	Assets Retirement Obligations	Environmental Liability	Enterprise Social Commitment	Legal Cases	Renewable Power Obligation	Miscellaneous Provisions	Total
<b>Balance as at April 01, 2020</b>	<b>95</b>	<b>53</b>	<b>144</b>	<b>425</b>	<b>171</b>	<b>13</b>	<b>901</b>
Provision made during the year	-	16	-	12	75	-	103
Reclassified	-	-	-	-	-	-	-
Provision utilised during the year	-	(7)	(5)	(67)	(33)	-	(112)
Provision reversed during the year (c) and (d)	-	-	-	(39)	(57)	-	(96)
Unwinding of discount	4	1	9	-	-	-	14
<b>Balance as at March 31, 2021</b>	<b>99</b>	<b>63</b>	<b>148</b>	<b>331</b>	<b>156</b>	<b>13</b>	<b>810</b>
Provision made during the year	6	200	-	53	112	-	371
Reclassified	-	-	-	-	-	-	-
Provision utilised during the year	(1)	(2)	(10)	(1)	(107)	(1)	(122)
Provision reversed during the year (c)	-	-	-	-	(13)	-	(13)
Unwinding of discount	6	1	10	-	-	-	17
<b>Balance as at March 31, 2022</b>	<b>110</b>	<b>262</b>	<b>148</b>	<b>383</b>	<b>148</b>	<b>12</b>	<b>1,063</b>

# Notes

forming part of the Standalone Financial Statements

## (b) Brief Description of Provisions

### i) Assets Retirement Obligations

Asset Retirement Obligation (ARO) is a legal or constructive obligation associated with the ash ponds, ash pipeline and coal transportation system at captive power plants, red mud ponds at refineries and mining area where these lands need to be restored back to usable condition after closing of activities. This is a statutory requirement in which the timing or method of settlement may be conditional on one or multiple future events, the occurrence of which may not be within the control of the entity. The outflow of economic resources is expected during FY 23 to FY 47. The same has been appropriately discounted.

### ii) Environmental Liability

Environmental Liability associated with Wild Life Conservation Plan (WLCP) and disposal of hazardous material generated during the course of manufacturing or mining operation e.g. disposal of spent pot lining, Gypsum, Slag, Ash etc. This disposal generally takes place as per the guidelines set by various regulatory authorities of States and Central Government. The outflow of economic resources is generally expected during FY 23 to FY 31.

### iii) Enterprise Social Commitment

Enterprise Social Commitment is the amount to be spent on social and economic development of the surrounding area where new project is being setup. This is generally defined as a certain percentage of the total cost of the project. The outflow of economic resources is expected during FY 23 to FY 56. This has been appropriately discounted wherever necessary.

### iv) Legal Cases

There are few Legal cases against which provision has been made since these events are probable to happen i.e. more likely than not but timing of occurrence of such events is uncertain as it depends on when the matter will be settled at the highest Court of Law.

### v) Renewable Power Obligation (RPO)

Some of our units situated in various states like Odisha, Madhya Pradesh, Maharashtra, Gujarat, Jharkhand etc. who gets power from Captive power plants or procure power from open source, are obligated to purchase certain portion of their power consumption from Renewable Energy sources both solar and non-solar. This gives rise to Renewable Power Obligation (RPO). In case the obligated units fail to procure power from such renewable sources, they may satisfy the obligation by purchasing Renewable Energy Certificates from authorised exchanges as an alternative.

### vi) Miscellaneous Provision

Includes Statutory provisions related to Indirect Taxes, Coal Cess etc.

## (c) Reversal of RPO Provision

Pursuant to the issuance of notification by Madhya Pradesh Electricity Regulatory Commission (MPERC), the Company has reversed the excess RPO provision of ₹ 13 crore related to FY 21 in current year and during previous year pursuant to the issuance of notification by Madhya Pradesh Electricity Regulatory Commission (MPERC) dated April 05, 2021, the Company has reversed the excess RPO provision of ₹ 21 crore related to FY 20. Additionally ₹ 36 crore has been reversed on account of reduction in Solar certificate rate from ₹ 2,400/REC to ₹ 1,000/REC.

## (d) Reversal of Legal cases Provision

During previous year reversal of ₹ 39 crore includes reversal of ₹ 37 crore on account of UP Transit Fees and ₹ 2 crore on account of Energy Compensation Charges.

## 23 Income Taxes

Refer Note 1B (W) for accounting policy on Income Taxes

### A Current Tax and Deferred Tax Expense

	(₹ in Crore)	
	Year ended	
	31/03/2022	31/03/2021
<b>(a) Income tax expenses recognised in Statement of Profit and Loss</b>		
Current Tax		
Current income tax Expenses for the year	1,496	283
Tax Adjustment for earlier years	-	-
	<b>1,496</b>	<b>283</b>
Deferred Tax		
Deferred Income Tax (benefits)/expenses for the year	1,057	581
MAT Credit Entitlement	397	(283)
	<b>1,454</b>	<b>298</b>
<b>Total Income Tax Expenses recognised in Statement of Profit and Loss for the year</b>	<b>2,950</b>	<b>581</b>
<b>(b) Reconciliation of estimated Income Tax Expenses at Indian Statutory Income Tax Rate to Income Tax Expenses reported in Statement of the Comprehensive Income</b>		
Profit before Income Taxes	8,457	1,574
Indian Statutory Income Tax Rate *	34.94%	34.94%
Estimated Income Tax Expenses	<b>2,955</b>	<b>550</b>
<b>Tax effect of adjustments to reconcile expected Income Tax expenses to reported Income Tax Expenses:</b>		
Income Exempt from Tax	(1)	(1)
Long-Term Capital (Gains)/Loss	(3)	(3)
Expenses not deductible in determining Taxable Profit	51	28
Deduction on Power Plant net of Reversal of depreciation on 80IA Assets during tax holiday period	(13)	-
Exchange gain on Return of Capital	(56)	-
Deferred Tax Adjustment for earlier years	17	7
Current Tax Adjustment for earlier years	-	-
	<b>(5)</b>	<b>31</b>
<b>Income Tax Expenses recognised in the Statement of Profit and Loss</b>	<b>2,950</b>	<b>581</b>
*Applicable Indian statutory tax rate for the years ended 31/03/2022 and 31/03/2021 is 34.94%.		
<b>(c) Income Tax expenses recognised in OCI</b>		
Remeasurement of Defined Benefit Obligations	(3)	20
Change in Fair Value of Debt and Equity Instruments designated at FVTOCI	231	(3)
Cash Flow Hedges and Others	(679)	(323)
	<b>(451)</b>	<b>(306)</b>
<b>(d) Income Tax expense recognised directly in Equity</b>		
Basis adjustment on Cash flow hedges & others	(21)	(1)
	<b>(21)</b>	<b>(1)</b>



# Notes

forming part of the Standalone Financial Statements

## B Deferred Tax Assets and Liabilities

(₹ in Crore)

	Year ended	
	31/03/2022	31/03/2021
<b>Deferred Tax Assets</b>		
Deferred Tax Assets	1,845	2,105
MAT Credit Entitlement	2,040	2,436
	<b>3,885</b>	<b>4,541</b>
<b>Deferred Tax Liabilities</b>		
Deferred Tax Liabilities	(6,833)	(6,507)
	<b>(6,833)</b>	<b>(6,507)</b>
<b>Net Deferred Tax Assets/ (Liabilities)</b>	<b>(2,948)</b>	<b>(1,966)</b>

### a) Movement in Deferred Tax Assets and (Liabilities) as of and during the year ended.

(₹ in Crore)

	Opening Balance 01/04/2021	Recognised in the Statement of Profit and Loss	Recognised in Other Comprehensive Income	Deferred tax on basis adjustment	As at 31/03/2022
<b>Deferred Income Tax Assets</b>					
Provisions deductible for tax purposes in future period	481	44	-	-	525
Tax Losses/Benefits carry forwards, Net #	1,015	(1,015)	-	-	-
Retirement Benefits and Compensated Absences	71	(15)	3	-	59
Deferred Income	207	(7)	-	-	200
Cash flow hedges	316	-	679	21	1,016
MAT Credit Entitlement	2,436	(396)	-	-	2,040
Others	15	30	-	-	45
	<b>4,541</b>	<b>(1,359)</b>	<b>682</b>	<b>21</b>	<b>3,885</b>
<b>Deferred Income Tax Liabilities</b>					
PP&E Depreciation and Intangible Amortisation	(6,470)	(88)	-	-	(6,558)
Cash Flow Hedges	-	-	-	-	-
Fair Value Measurements of Financial Instruments	(37)	(7)	(231)	-	(275)
Others	-	-	-	-	-
	<b>(6,507)</b>	<b>(95)</b>	<b>(231)</b>	<b>-</b>	<b>(6,833)</b>
<b>Net Deferred Tax Assets/(Liabilities)</b>	<b>(1,966)</b>	<b>(1,454)</b>	<b>451</b>	<b>21</b>	<b>(2,948)</b>

(₹ in Crore)

	As at 01/04/2020	Recognised in the Statement of Profit and Loss	Recognised in Other	Deferred tax on basis adjustment	As at 31/03/2021
<b>Deferred Income Tax Assets</b>					
Provisions deductible for tax purposes in future period	465	16	-	-	481
Tax Losses/Benefits carry forwards, Net #	1,735	(720)	-	-	1,015
Retirement Benefits and Compensated Absences	102	(11)	(20)	-	71
Deferred Income	216	(9)	-	-	207
Cash Flow Hedges	-	-	315	1	316
MAT Credit Entitlement	2,153	283	-	-	2,436
Others	-	15	-	-	15
	<b>4,671</b>	<b>(426)</b>	<b>295</b>	<b>1</b>	<b>4,541</b>

### Deferred Income Tax Liabilities

PP&E Depreciation and Intangible Amortisation	(6,424)	(46)	-	-	(6,470)
Cash Flow Hedges	(8)	-	8	-	-
Fair Value Measurements of Financial Instruments	(116)	76	3	-	(37)
Others	(98)	98	-	-	-
	<b>(6,646)</b>	<b>128</b>	<b>11</b>	<b>-</b>	<b>(6,507)</b>
<b>Net Deferred Tax Assets/(Liabilities)</b>	<b>(1,975)</b>	<b>(298)</b>	<b>306</b>	<b>1</b>	<b>(1,966)</b>

# Tax Losses/Benefits carry forwards represents deferred income tax asset on unabsorbed depreciation carried forward under the Income Tax Act, for which there is no expiry period.

- (b) Deferred tax assets and deferred tax liabilities have been offset wherever the Company has a legally enforceable right to set-off current tax assets against current tax liabilities and where the deferred tax assets and deferred tax liabilities relates to income tax levied by the same taxation authorities.
- (c) The Company has not recognised deferred tax assets on following long term capital losses as presently it is not probable of recovery.

(₹ in Crore)

Description	AY <sup>®</sup>	Amount	Tax impact	Year of Expiry
Long Term Capital Loss	2015-16	29	7	AY 2023-24
Long Term Capital Loss	2016-17	34	8	AY 2024-25
Long Term Capital Loss	2017-18	901	210	AY 2025-26

<sup>®</sup> Assessment Year (AY).

- (d) The Company has not recognised deferred tax asset in respect of deductible temporary differences related to its subsidiaries and associates as presently it is not probable that future taxable long term capital gain will be available in the foreseeable future to recover such deferred tax assets.

# Notes

forming part of the Standalone Financial Statements

(e) The Taxation Law (Amendments) Ordinance 2019 ('the Ordinance'), provides an option to domestic companies to pay income-tax at a lower rate of 22% (plus applicable surcharge and cess) instead of the normal rate of 30% (plus applicable surcharge and cess) depending on the conditions specified in this behalf under section 115BAA of the Income Tax Act, 1961. A domestic company can avail of the lower tax rate only if it opts for not availing of certain exemptions or incentives specified in this behalf in the Ordinance. There is no time limit prescribed under the above to choose the option of lower tax rate under section 115BAA, however, once chosen it is irreversible. The Company is having accumulated MAT credit and tax incentives to be availed/adjusted against future taxable profits. Based on the projections prepared by the management, including its plan for future capital expenditure for capacity enhancement, the company has determined that exercising the option of lower rate will be beneficial only in long term. Accordingly, the Company has not exercised this option during the period and continues to recognize the taxes on income for period ended March 31, 2022 as per the existing normal tax rate of 30% (plus applicable surcharge and cess). The Company has assessed that the net deferred tax liability as at March 31, 2022 would get reversed within the period for which Company is expected to continue to be in the existing tax regime. The Company will review the above position at each period end.

## C Income Tax Assets and Liabilities with Tax Authorities

(₹ in Crore)

	As at	
	31/03/2022	31/03/2021
<b>Income Tax Assets</b>		
Non-Current Tax Assets (Net)	-	-
	-	-
<b>Income Tax Liabilities (Net)</b>		
Current Tax Liabilities (Net)	1,121	1,168
	<b>1,121</b>	<b>1,168</b>

The Company is subject to tax assessments and ongoing proceedings, which are pending before various Tax Appellate Authorities. Management periodically evaluates the positions taken in tax returns with respect to above matters, including unresolved tax disputes, which involves interpretation of applicable tax regulations and judicial precedents. Current tax liability and tax asset balances are presented, after recognising as appropriate, provision for taxes payable and contingencies basis management's assessment of outcome of such ongoing proceedings and amounts that may become payable to the tax authorities. Considering the nature of such estimates and uncertainties involved, the amount of such provisions may change upon final resolution of the matters with tax authorities, refer note 1D.

## 24. Contract Liabilities

Refer Note 1B (X) for accounting policy on Contract Liability

(₹ in Crore)

	As at	
	31/03/2022	31/03/2021
Advance from Customers, (refer note - 26)	180	136
	<b>180</b>	<b>136</b>
<b>Reconciliation of contract liabilities for the periods presented:</b>		
<b>Balance at beginning of the year</b>	<b>136</b>	<b>158</b>
Amount received during the year against which revenue has not been recognized	165	128
<b>Revenue recognized during the year</b>		
a) Contract liabilities at the beginning of the year	(121)	(150)
b) Performance obligations satisfied in previous years	-	-
<b>Balance at end of the year</b>	<b>180</b>	<b>136</b>

## 25. Other Non Current and Current Liabilities

(₹ in Crore)

	As at			
	31/03/2022		31/03/2021	
	Non-Current	Current	Non-Current	Current
Customer Refund Liability - [(a) & (refer note - 26)]	-	119	-	83
Statutory Dues Payable	-	487	-	441
Deferred Income - (b)	554	20	573	21
Other Payable	31	21	36	20
	<b>585</b>	<b>647</b>	<b>609</b>	<b>565</b>

(a) Customer refund liability are recognised mainly for discount payable to customers.

(b) Represents deferred income in respect of grant related to Export Promotion Capital Goods (EPCG) at Aditya, Mahan and Mouda.

## 26. Revenue from Operations

Refer Note 1B (X) for accounting policy on Revenue recognition

Refer Note 1B (T) for accounting policy on Accounting for government grants

(₹ in Crore)

	Year ended	
	31/03/2022	31/03/2021
<b>Revenue from Contracts with Customers</b>		
Sale of Products - (a)		
Domestic Sales - (b)	44,274	26,885
Export Sales	21,318	13,889
	<b>65,592</b>	<b>40,774</b>
Trade Sales - (b)	1,140	1,414
Sale of Services - (c)	233	119
	<b>66,965</b>	<b>42,307</b>
<b>Other Operating Revenues - (a) and (d)</b>	688	394
	<b>67,653</b>	<b>42,701</b>
<b>Reconciliation of revenue recognised with contract price:</b>		
<b>Contract Price</b>	<b>70,478</b>	<b>43,502</b>
Adjustments for:		
Refund Liabilities and discounts	(779)	(497)
Hedging Gain/ (Loss)	(2,614)	(607)
Others - Provisionally priced contracts	(120)	(91)
<b>Revenue from Contracts with Customers</b>	<b>66,965</b>	<b>42,307</b>

## Notes

forming part of the Standalone Financial Statements

- (a) Sales of Copper products and precious metals are accounted for provisionally, pending finalization of price and quantity. Variations are accounted for in the period of settlement. Final price receivable on sale of above products for which provisional price was not finalized are realigned at year end forward LME/LMBA rate and is being presented as part of other operating revenue. Revenue from subsequent variation in price movement is loss of ₹ 24 crore (year ended 31/03/2021, loss of ₹ 31 crore).
- (b) Includes nutrient based subsidy of Phosphorus (P) & Potassium (K) arising from sale of Di ammonium phosphate (DAP) ₹ 441 crore (year ended 31/03/2021 ₹ 402 crore).
- (c) Sale of services predominantly include freight and insurance on exports which are identified as separate performance obligation under Ind AS 115.
- (d) Includes Government Grant in the nature of sales related export Incentives and other benefits of ₹ 408 crore (year ended 31/03/2021 ₹ 211 crore).
- (e) The amount of its revenue from external customers analysed by the country, in which customers are located, are given below:

	(₹ in Crore)	
	Year ended	
	31/03/2022	31/03/2021
<b>India</b>	45,597	28,508
<b>Outside India</b>		
China	5,976	3,026
Korea	6,352	4,266
Others	9,320	6,690
<b>Total Revenue from customers</b>	<b>67,245</b>	<b>42,490</b>
Add: Export Incentive and other benefits	408	211
<b>Total Revenue from Operations</b>	<b>67,653</b>	<b>42,701</b>

- (f) Refer note - 43, for related party transactions.
- (g) Applying the practical expedient as given in Ind AS 115, the Company has not disclosed the remaining performance obligations related disclosures for contracts where revenue recognized corresponds directly with value to the customer of the entity's performance completed to date.

### 27. Other Income

Refer Note 1B (Y) for accounting policy on Dividend and Interest Income  
 Refer Note 1B (T) for accounting policy on Accounting for government grants  
 Refer Note 1B (P) for accounting policy on Accounting for Financial Instruments

	(₹ in Crore)	
	Year ended	
	31/03/2022	31/03/2021
Interest Income, (refer note - 47(A)(c))		
On Non-Current Investments	20	13
On Current Investments	35	24
On Others - (a)	89	68

	(₹ in Crore)	
	Year ended	
	31/03/2022	31/03/2021
Dividend Income, (refer note - 47(A)(c))		
On Non-Current Investments - (a)	31	18
Rent Income (a)	18	13
Income from Government Grants	20	21
Gain/ (Loss) on Property, Plant and Equipment and Intangible Assets sold/ discarded (Net)	(31)	(20)
Gain/ (Loss) on Financial Investments Measured at FVTPL (Net)		
On sale of Financial Assets	245	643
On change of Fair Value of Financial Assets	18	(222)
Other Non-Operating Income - (b)	90	92
	<b>535</b>	<b>650</b>

- (a) Refer note - 43, for related party transactions.
- (b) Includes gain on modification of borrowings of ₹ 53 crore (year ended 31/03/2021 ₹ 56 crore) resulting from change in benchmark interest rate and timing of expected cash flows on term loans.

### 28. Cost of Materials Consumed

	(₹ in Crore)	
	Year ended	
	31/03/2022	31/03/2021
Copper Concentrate - (a)	26,677	15,451
Alumina	3,265	2,840
Bauxite	668	540
Caustic Soda	456	300
Calcined Petroleum Coke	2,081	1,112
Copper Anode	2,741	1,904
Copper Cathodes	3,940	3,911
Pitch	703	355
Others	1,448	765
	<b>41,979</b>	<b>27,178</b>

- (a) Purchase of copper concentrate is accounted for provisionally pending finalization of contents in the concentrate and price. Variations are accounted for in the period of settlement. Final price payable on purchase of copper concentrate for which provisional price and quantity were not finalized during the year are realigned based on forward LME and LBMA rate. Impact on cost from subsequent variation in price movement for year ended 31/03/2022 was loss of ₹ 922 crore (year ended 31/03/2021 was loss of ₹ 160 crore).
- (b) Refer note 37, for details of freight expenses included in cost of material consumed.



# Notes

forming part of the Standalone Financial Statements

## 29. Trade Purchases

	(₹ in Crore)	
	Year ended	
	31/03/2022	31/03/2021
Aluminum Rolled Product	256	126
Fertilizer - (a)	1,530	928
Others	136	44
	<b>1,922</b>	<b>1,098</b>

(a) During the previous year, the Fertilizer plant was shut for regular maintenance and during the current year, Company has discontinued and impaired the Fertilizer plant. Thus, for both years, to cater to the domestic demand, the Company has imported the fertilizer products i.e. Di Ammonium Phosphate (DAP) and Nitrogen, Phosphorus and Potassium (NPK).

## 30. Changes in Inventories of Finished Goods, Work-in-Progress and Stock-in-Trade

	(₹ in Crore)					
	Opening Inventories		Closing Inventories		Net Change	
	as at		as at		Year ended	
	1/04/2021	1/04/2020	31/03/2022	31/03/2021	31/03/2022	31/03/2021
Work-in-Progress	6,428	4,595	8,268	6,428	(1,840)	(1,833)
Finished Goods	1,448	1,337	2,080	1,448	(632)	(111)
Stock-in-Trade	4	127	884	4	(880)	123
	<b>7,880</b>	<b>6,059</b>	<b>11,232</b>	<b>7,880</b>	<b>(3,352)</b>	<b>(1,821)</b>
Inventories acquired in business combination (refer note - 53)					8	-
	<b>7,880</b>	<b>6,059</b>	<b>11,232</b>	<b>7,880</b>	<b>(3,344)</b>	<b>(1,821)</b>

Details of inventories under broad heads are given below:

	(₹ in Crore)							
	Work-in-Progress		Finished Goods		Stock-in-Trade		Total	
	As at		As at		As at		As at	
	31/03/2022	31/03/2021	31/03/2022	31/03/2021	31/03/2022	31/03/2021	31/03/2022	31/03/2021
Alumina	393	299	93	59	-	-	486	358
Aluminium and Aluminium Products	1,108	792	461	388	17	2	1,586	1,182
Copper and Copper Products	4,287	3,507	1,327	987	-	-	5,614	4,494
Precious Metals	1,393	1,079	186	5	-	-	1,579	1,084
Others - (a)	1,087	751	13	9	867	2	1,967	762
	<b>8,268</b>	<b>6,428</b>	<b>2,080</b>	<b>1,448</b>	<b>884</b>	<b>4</b>	<b>11,232</b>	<b>7,880</b>

(a) Others include mainly inventories of own mined coal, anode, soda in process, Di Ammonium Phosphate (DAP), Nitrogen, Phosphorus and Potassium (NPK) and other materials.

## 31. Employee Benefits

Refer Note 1B (U) for accounting policy on Employee Benefits  
Refer Note 1B (V) for accounting policy on Employee Share-based Payments

### A Total employee benefit expenses incurred by the Company during the year as below

	(₹ in Crore)	
	Year ended	
	31/03/2022	31/03/2021
Salaries and Wages	1,689	1,507
Post-Employment Benefits:		
Gratuity and Other Defined Benefit Plans	55	64
Contribution to Provident Fund and Other Defined Contribution Funds	116	115
Employee Share-Based Payments, (refer note - 42)		
Equity-settled share-based payment	35	15
Cash-settled share-based payment	5	1
Employee Welfare Expenses	181	156
	<b>2,081</b>	<b>1,858</b>
Less: Transferred to Capital Work-in-Progress/ Intangible Assets under development	23	14
	<b>2,058</b>	<b>1,844</b>

- (i) The Code on Social Security, 2020 ('Code') relating to employee benefits during employment and post employment benefits received Presidential assent in September 2020. The Code has been published in the Gazette of India. However, the date on which the Code will come into effect has not been notified. The Company will assess the impact of the Code when it comes into effect and will record any related impact in the period the Code becomes effective.
- (ii) The Hon'ble Supreme Court of India ("SC") by their order dated February 28, 2019, in the case of Surya Roshani Limited v/s EPFO, set out the principles based on which allowances paid to the employees should be identified for inclusion in basic wages for the purposes of computation of Provident Fund contribution. The Company has given effect of the above judgement effective March 1, 2019. This does not have any material impact on the Financial Statements.

### B Post-Employment Benefits

The Company provides various benefit plan to its employees. Some of them are defined benefit in nature while some are contributory.

#### I Defined Benefit Plans:

Major Post retirement defined benefit plans of the Company include Gratuity, Post retirement medical benefit and Provident Fund (to the extent of Company's obligation to fund any shortfall on the yield of the trust's investments over the administered interest rates on an annual basis by Central Provident Fund Organisation of Govt of India). The Company does Actuarial valuation for its identified long term and short term defined benefit plans.

#### Methodology for actuarial valuation of Defined Benefit Obligations:

The Projected Unit Credit (PUC) actuarial method has been used to assess the plan's liabilities, including those related to death-in-service and incapacity benefits.

Under PUC method a projected accrued benefit is calculated at the beginning of the year and again at the end of the year for each benefit that will accrue for all active members of the plan. The projected accrued benefit is based on the plan's accrual formula and upon service as of the beginning or end of the year, but using a member's final compensation, projected to the age at which the employee is assumed to leave active service. The plan liability is the actuarial present value of the projected accrued benefits for active members.

# Notes

forming part of the Standalone Financial Statements

Defined benefit plans expose the Company to actuarial risks such as: Interest Rate Risk, Salary Risk and Demographic Risk.

- i. Interest Rate Risk: While calculating the defined benefit obligation a discount rate based on government bonds yields of matching tenure is used to arrive at the present value of future obligations. If the bond yield falls, the defined benefit obligation will tend to increase and plan assets will decrease.
- ii. Salary risk: Higher than expected increases in salary will increase the defined benefit obligation.
- iii. Demographic risk: This is the risk of variability of results due to unsystematic nature of decrements that include mortality, withdrawal, disability and retirement. The effect of these decrements on the defined benefit obligations is not straight forward and depends on the combination of salary increase, discount rate and vesting criteria. It is important not to overstate withdrawals because in the financial analysis the retirement benefit of a short career employee typically costs less per year as compared to a long service employee.

## A Gratuity Plans

The Company has various schemes (funded/unfunded) for payment of gratuity to all eligible employees calculated at specified number of days (ranging from 15 days to 1 month) of last drawn salary depending upon the tenure of service for each year of completed service subject to minimum service of five years payable at the time of separation upon superannuation or on exit otherwise. These defined benefit gratuity plans are governed by Payment of Gratuity Act, 1972.

(₹ in Crore)

	Year ended	
	31/03/2022	31/03/2021
<b>(a) Change in Defined Benefit Obligations (DBO)</b>		
DBO at the beginning of the year	1,113	1,094
Current service cost	46	49
Interest Cost on the DBO	68	70
Settlement cost/(credit)	-	4
Acquisitions cost	2	-
Actuarial (gain)/ loss - experience	21	(50)
Actuarial (gain)/ loss - financial assumption	(67)	22
Benefits paid directly by Company	(47)	(44)
Benefits paid from plan assets	(26)	(32)
<b>DBO at the end of the year</b>	<b>1,110</b>	<b>1,113</b>

(₹ in Crore)

	Year ended	
	31/03/2022	31/03/2021
<b>(b) Change in Fair Value of Plan Assets</b>		
Fair Value of Plan Assets at the beginning of the year	984	884
Interest Income on plan assets	62	58
Employer's contributions	52	53
Return on plan assets greater/(lesser) than discount rate	42	21
Benefits Paid	(26)	(32)
<b>Fair Value of Plan Assets at the end of the year</b>	<b>1,114</b>	<b>984</b>

(₹ in Crore)

	Year ended	
	31/03/2022	31/03/2021
<b>(c) Development of Net Balance Sheet Position</b>		
DBO, funded	(1,009)	(1,018)
Fair Value of Plan Assets	1,114	984
Funded Status {surplus/(deficit)}	105	(34)
Funded surplus not recognised - (n)	(105)	-
DBO, unfunded	(101)	(95)
<b>Net defined benefit asset/(liability) recognised in the Balance Sheet</b>	<b>(101)</b>	<b>(129)</b>

(₹ in Crore)

	Year ended	
	31/03/2022	31/03/2021
<b>(d) Reconciliation of Net Balance Sheet Position</b>		
Net Defined benefit asset/(Liability)at beginning of the year	(129)	(210)
Service cost	(46)	(49)
Settlement cost/(credit)	-	(4)
Net Interest on net defined benefit liability/(asset)	(6)	(12)
Amount recognised in OCI	88	49
Funded surplus not recognised - (n)	(105)	-
Employer's contributions	52	53
Benefit paid directly by Company	47	44
Acquisition credit/(cost)	(2)	-
<b>Net Defined benefit asset/(Liability)at the end of the year</b>	<b>(101)</b>	<b>(129)</b>

(₹ in Crore)

	Year ended	
	31/03/2022	31/03/2021
<b>(e) Expense recognised during the year</b>		
Current Service cost	46	49
Settlement cost/ (credit) - <sup>5</sup>	-	4
<b>Total Service Cost</b>	<b>46</b>	<b>53</b>
Net Interest on net defined benefit liability/(asset)	6	12
Net Gratuity Cost	52	65

<sup>5</sup> Settlement cost/ (credit) during the year has been accounted under Exceptional Expenses as it pertains to Voluntary Retirement Scheme (VRS) granted at our Mines, Gare Palma (refer note - 38)

# Notes

forming part of the Standalone Financial Statements

(₹ in Crore)

	Year ended	
	31/03/2022	31/03/2021
<b>(f) Other Comprehensive Income(OCI)</b>		
Actuarial (Gain)/ Loss due to DBO experience	21	(50)
Actuarial (Gain)/ Loss due to DBO assumption changes	(67)	22
Actuarial (Gain)/ Loss arising during the period	(46)	(28)
Return on Plan Assets (greater)/less than discount rate	(42)	(21)
Funded surplus not recognised - (n)	105	-
<b>Actuarial (Gain)/ Loss recognised in OCI</b>	<b>17</b>	<b>(49)</b>

(₹ in Crore)

	Year ended	
	31/03/2022	31/03/2021
<b>(g) Defined Benefit Costs</b>		
Service Cost	46	53
Net Interest on net defined benefit liability/(asset)	6	12
Actuarial (gain)/loss recognised in OCI	(88)	(49)
Funded surplus not recognised - (n)	105	-
<b>Defined Benefit Cost</b>	<b>69</b>	<b>16</b>

	Year ended	
	31/03/2022	31/03/2021
<b>(h) Principal Actuarial Assumptions</b>		
Discount rate (based on the market yields available on Government bonds at the accounting date with a term that matches that of the liabilities)	7.00%	6.25%
Salary escalation rate	7.50%	7.50%
Weighted average duration of the defined benefit obligation	8 years	9 years
<b>Mortality Rate</b>	Indian Assured Lives Mortality (2006-08) Ultimate	

	Year ended	
	31/03/2022	31/03/2021
<b>(i) Non-Current and Current portion of Defined Benefit Obligations (Refer Note - 22)</b>		
Current portion	(5)	(3)
Non-current portion	(96)	(126)
	<b>(101)</b>	<b>(129)</b>

## (j) Sensitivity analysis

Sensitivity analysis are based on a change in an assumption while holding all other assumptions constant. In practice, this is unlikely to occur, and changes in some of the assumptions may be co-related. When calculating the sensitivity of the defined benefit obligation to significant actuarial assumptions, the same method (present value of the defined benefit obligation calculated with the projected unit credit method at the end of the reporting period) has been applied as when calculating the defined benefit liability recognised in the balance sheet.

(₹ in Crore)

	Year ended	
	31/03/2022	31/03/2021
<b>Discount Rate</b>		
Effect on DBO due to 1% increase in discount rate	(80)	(85)
Effect on DBO due to 1% decrease in discount rate	92	98
<b>Salary Escalation Rate</b>		
Effect on DBO due to 1% increase in salary escalation rate	90	96
Effect on DBO due to 1% decrease in salary escalation rate	(81)	(85)

(₹ in Crore)

## (k) The Expected Maturity Analysis of Undiscounted Gratuity is as follows:

	Year ended	
	31/03/2022	31/03/2021
Within 1 year	66	57
From 1 year to 2 Year	99	88
From 2 year to 3 Year	102	97
From 3 year to 4 Year	106	95
From 4 year to 5 Year	110	104
From 5 year to 10 Year	618	577

## (l) Composition of Plan Assets

Major categories of Plan Assets are as under: \*

	31/03/2022	31/03/2021
Cash & Bank Balances	1.37%	1.57%
Scheme of insurance - Conventional product	0.20%	0.21%
Scheme of insurance - ULIP product	98.43%	98.23%
	<b>100.00%</b>	<b>100.00%</b>

\* Investment in Plan assets are unquoted.

(m) Expected Contributions to post employment benefit plan of Gratuity for the year ending 31st March, 2023 are ₹ 61 crore.

(n) The Company has not recognised the surplus in its plan assets of gratuity fund since no future economic benefits are expected in the form of reduction in future contributions to the gratuity plan or refund from the gratuity plan.



# Notes

forming part of the Standalone Financial Statements

## B Post Retirement Medical Benefit

This is a defined benefit plan where the Company provides post retirement medical benefit to its certain retired employees. The scheme involves reimbursement of expenses towards medical treatment of self and dependents. The amount charged to the statement Profit and Loss during the year is ₹ 0.32 crore (year ended 31/03/2021 ₹ 0.34 crore) and amount of actuarial (gain)/ loss recognised in Other Comprehensive Income during the year is ₹ (4) crore (year ended 31/03/2021 ₹ (1) crore). The obligation with respect to said scheme as at 31/03/2022 ₹ 5 crore ( year ended 31/03/2021 ₹ 5 crore) .

## C Other Pension Plan

It is a pension benefit provided to erstwhile Managing Director. The amount charged to statement of Profit and Loss during the year is ₹ 3 crore (year ended 31/03/2021 ₹ 3 crore). Amount of actuarial (gain)/ loss recognised in Other Comprehensive Income during the year is ₹ 0 crore (year ended 31/03/2021 ₹ 1 crore). The obligation with respect to these schemes as at 31/03/2022 ₹ 47 crore ( year ended 31/03/2021 ₹ 46 crore).

## II Defined Contribution Plans

### A Pension

It is a contributory benefit plan where the Company contributes a certain percentage of salary for all eligible employees in the managerial cadre towards Superannuation Funds with option to put certain portion in National Pension Scheme (NPS) and/or in funds managed by Birla Sunlife Insurance Company to be converted to annuity of Life Insurance Corporation of India at retirement. Junior Pension Plan provided to certain employees is in the nature of defined benefit plan which provides an annuity in the form of pension amount at retirement. The amount charged to statement of Profit and Loss during the year is ₹ 16 crore (year ended 31/03/2021 ₹ 15 crore). Amount of actuarial (gain)/ loss recognised in Other Comprehensive Income during the year is ₹ 0 crore (year ended 31/03/2021 ₹ 0 crore).

### B Provident Fund

The Company's contribution towards Provident Fund managed either by approved trusts or by the Central Government is debited to the Statement of Profit and Loss. In respect of provident fund management by the approved trust, the Company has an obligation to fund any shortfall on the yield of the trust's investments over the administered interest rates on an annual basis. The Company also contributes to Coal Mines Provident Fund (CMPF) in respect of employees working in coal mines. The amount debited to Statement of Profit and Loss during the year was ₹ 100 crore (year ended 31/03/2021 ₹ 100 crore). Based on actuarial valuation, the Company has recognised obligation of ₹ 0 crore as at 31/03/2022 (year ended 31/03/2021 ₹ 2 crore) towards shortfall on the yield of the trust's investments over the administered interest rates. Amount of actuarial (gain)/ loss recognised in Other Comprehensive Income during the year is ₹ (4) crore (year ended 31/03/2021 ₹ (9) crore).

(₹ in Crore)

	Year ended	
	31/03/2022	31/03/2021
<b>Sensitivity Analysis :-</b>		
<b>Provident Fund</b>		
<b>Discount Rate</b>		
Effect on DBO due to 1% increase in discount rate	(3)	(3)
Effect on DBO due to 1% decrease in discount rate	4	4
<b>Pension</b>		
<b>Discount Rate</b>		
Effect on DBO due to 1% increase in discount rate	(0.0)	(0.1)
Effect on DBO due to 1% decrease in discount rate	0.1	0.1

## Assumption use in determining the present value obligation of the interest rate guarantee under the Deterministic Approach:

	Year ended	
	31/03/2022	31/03/2021
Discount rate	7.00%	6.25%
Expected EPFO (Employees' Provident Fund Organisation) Return	8.10%	8.50%

## III Other Employee Benefit plans

### A Leave Obligation

The leave obligation cover the Company's liability for earned and sick leave. The entire amount of the provision of ₹ 261 crore (year ended 31/03/2021 ₹ 257 crore) is presented as current, since the company does not have an unconditional right to defer settlement for these obligations. Expected amount towards settlement of Leave for the next 12 months are ₹ 41 crore (31/03/2021 ₹ 36 crore).

## 32. Power and Fuel

(₹ in Crore)

	Year ended	
	31/03/2022	31/03/2021
Power and Fuel Expenses - (a)	6,782	5,668
Less: Transferred to Capital Work-in-Progress/ Intangible Assets under development	(1)	-
	<b>6,781</b>	<b>5,668</b>

(a) Refer note 37, for details of freight expenses included in Power and Fuel.

## 33. Finance Costs

Refer Note 1B (S) for accounting policy on Borrowing cost

(₹ in Crore)

	Year ended	
	31/03/2022	31/03/2021
Interest Expenses on Financial Liabilities not at FVTPL - (a) and (b)	1,388	1,451
(Gain)/ Loss on Foreign Currency Borrowings (Net)	-	(14)
Interest Expenses for Leasing arrangements	26	25
Other Borrowing Costs - (c)	29	22
	<b>1,443</b>	<b>1,484</b>
Less: Transferred to Capital Work-in-Progress/ Intangible Assets under development (d)	26	15
	<b>1,417</b>	<b>1,469</b>

- (a) Interest expenses include ₹ 9 crore (year ended 31/03/2021 ₹ 6 crore) paid to Income Tax Department.
- (b) Includes difference between effective interest rate and contracted interest rate of ₹ 57 crore (year ended 31/03/2021 ₹ 49 crore) mainly from amortisation of debt issuance cost.
- (c) Mainly includes unwinding of discount on Enterprise Social Commitment and Asset Retirement Obligations.
- (d) The Capitalisation rate used to determine the amount of borrowing costs to be capitalised is the weighted average interest rate applicable to general borrowings. Capitalisation rate for year ended 31/03/2022 is 6.32% p.a. (year ended 31/03/2021 - 6.58% p.a.).

# Notes

forming part of the Standalone Financial Statements

## 34. Depreciation and Amortisation Expenses

Refer Note 1B (D) for accounting policy on Property, Plant and Equipment  
Refer Note 1B (E) for accounting policy on Investment properties  
Refer Note 1B (F) for accounting policy on Intangible Assets  
Refer Note 1B (G) for accounting policy on Stripping cost  
Refer Note 1B (L) for accounting policy on Leases

	(₹ in Crore)	
	Year ended	
	31/03/2022	31/03/2021
Depreciation on Property, Plant and Equipment	1,576	1,590
Depreciation on Right of Use Assets	88	80
Depreciation on Investment Properties	-	1
Amortisation of Intangible Assets	92	44
	<b>1,756</b>	<b>1,715</b>
Less: Transferred to Capital Work-in-Progress/ Intangible Assets under development	4	7
	<b>1,752</b>	<b>1,708</b>

## 35. Impairment Loss on Non-Current Assets

Refer Note 1B (I) for accounting policy on Impairment of Non-Current Assets

	(₹ in Crore)	
	Year ended	
	31/03/2022	31/03/2021
Impairment Loss on Property, Plant and Equipment and Intangible assets (a) and (c)	76	115
Impairment Loss on Capital Work in Progress (b)	19	-
Impairment Loss - Asset Held for Sale (d)	-	25
	<b>95</b>	<b>140</b>

- (a) During the current year, the Company has evaluated operational performance along with current environmental norms of its Di Ammonium Phosphate (DAP) Plant and decided to decommission the same. As a result, the Company has recognized impairment in respect of existing DAP plant amounting to ₹ 76 crore.
- (b) The Company has impaired certain mining assets which was underutilized due to various reasons such as environmental clearances etc. amounting to ₹ 19 crore during the current year.
- (c) During the previous year, operation of certain mining assets of the Company have become unviable due to high cost of production and other operational issues. As a result the Company has recognized impairment in respect of these mining assets amounting to ₹ 115 crores (Property, Plant and Equipment ₹ 71 crore and Intangible assets ₹ 44 crore).
- (d) During the previous year, the Company has recognized impairment of ₹ 25 crores on certain other assets classified as "Non Current Asset Held for Sale" based on their future utilisation plan.

## 36. Impairment Loss on Financial Assets (Net)

Refer Note 1B (P) for accounting policy on Accounting for Financial Instruments

	(₹ in Crore)	
	Year ended	
	31/03/2022	31/03/2021
Provision for Doubtful Debts, Loans and other financial assets/ (written back) (Net)	1	(7)
Bad Debts Loans and other financial assets/ (written back) (Net)	1	-
	<b>2</b>	<b>(7)</b>

## 37. Other Expenses

	(₹ in Crore)	
	Year ended	
	31/03/2022	31/03/2021
Consumption of Stores and Spares	1,269	977
Repairs to Buildings	154	87
Repairs to Machinery	977	780
Rates and Taxes	57	13
Equipment and Material Handling Expenses	340	265
Lease Expenses - (c)	130	90
Insurance Charges	125	101
Payment to Auditors - (a)	5	5
Research and Development	31	23
Freight and Forwarding Expenses (Net) - (b) and (d)	1,012	767
Donation - (e)	10	6
Directors' Fees and Commission	7	6
(Gain)/Loss on Foreign Currency Transactions (Net)	(145)	(54)
(Gain)/Loss in Change in Fair Value of Derivatives (Net)	862	44
Miscellaneous Expenses - (f)	2,158	1,425
	<b>6,992</b>	<b>4,535</b>
Less: Transferred to Capital Work-in-Progress/ Intangible Assets under development	30	28
	<b>6,962</b>	<b>4,507</b>

(a) Details to Payment to Auditors are given below:

Statutory Auditors:		
Statutory Audit Fees <sup>^</sup>	4	4
Other Services	1	1
Reimbursement of Out-of-Pocket Expenses	-	-
Cost Auditors:		
Cost Audit Fee and Expenses	-	-
	<b>5</b>	<b>5</b>

<sup>^</sup> Statutory audit fees for year ended 31/03/2022 includes ₹ 1 crore towards additional fees for increase in scope. Statutory audit fees for year ended 31/03/2021 includes ₹ 1 crore towards additional fees for scope increase related to previous periods.

# Notes

forming part of the Standalone Financial Statements

(b) Freight and forwarding expenses is net of freight subsidy of ₹ 10 crore (year ended 31/03/2021 ₹ 54 crore) received on sale of DAP.

(c) Lease expense on account of Short Term Lease, Variable Lease and Low Value Lease on Low value assets are as follows:

Particulars	Year ended	
	31/03/2022	31/03/2021
	Short Term Leases	76
Variable lease	54	40
Leases of low value assets	-	-
<b>Total</b>	<b>130</b>	<b>90</b>

(d) Freight expenses amounting to ₹ 198 crore (year ended 31/03/2021 of ₹ 152 crore) is included in Cost of material consumed and ₹ 96 crore (year ended 31/03/2021 of ₹ 25 crore) is included in Power and Fuel expense. (refer notes 28 and 32).

(e) Donation includes ₹ 10 crore (year ended 31/03/2021 of Nil) paid to AB General Electoral Trust towards political donation.

(f) Miscellaneous expenses include ₹ 0.10 crore (year ended 31/03/2021 ₹ 0.04 crore) paid to a firm of solicitors in which one of the Director of the Company is a partner.

## 38. Exceptional Income/ (Expenses) (Net)

Refer Note 1B (Z) for accounting policy on Exceptional items

	Year ended	
	31/03/2022	31/03/2021
	Exceptional Income	-
Exceptional (Expenses)	(107)	(120)
	<b>(107)</b>	<b>7</b>

Details of Exceptional Income/ (Expenses) as follows:	Year ended	
	31/03/2022	31/03/2021
	<b>Exceptional Income:</b>	
Renewable Energy Certificates (REC) recognised subsequent to approval received from Odisha Electricity Regulatory Commission (OERC) permitting adjustment of excess REC purchased during earlier years against future Renewable Power Obligation (RPO) and reversal of excess Renewal Power Obligation (RPO) provision related to FY20 subsequent to Madhya Pradesh Electricity Regulatory Commission (MPERC) order.	-	127
<b>Total</b>	<b>-</b>	<b>127</b>
<b>Exceptional Expenses:</b>		
Exgratia amount paid to the employees for their contribution during COVID 19 pandemic.	-	(48)
Employee severance cost comprising voluntary retirement scheme offered to employees pursuant to the restructuring of a mining operation of the Company.	-	(33)

(₹ in Crore)

Details of Exceptional Income/ (Expenses) as follows:	Year ended	
	31/03/2022	31/03/2021
	Provision related to Additional Surcharge (ASC) and Cross Subsidy Surcharge (CSS) levied on the Company due to failure of the captive power producer (from whom the Company sourced power in earlier years) to comply with the captive status criteria under Central Electricity Act, 2003.	-
Pursuant to the notification by Ministry of Environment, Forest and Climate Change (MoEFCC), the Company has recognised provision for expected cost of disposal of legacy ash lying in ash dykes/ponds as at December 31, 2021. The above provision is estimated based on the plan for disposal of ash and stabilisation of ash dykes/ponds (subject to approval of Pollution Control Board) considering feasibility of extraction of ash from ash dykes/ponds.	(107)	-
<b>Total</b>	<b>(107)</b>	<b>(120)</b>

## 39. Other Comprehensive Income/ (Loss)

The disaggregation of changes to other comprehensive income (OCI) by each class is given below:

(₹ in Crore)

	Year ended					
	31/03/2022			31/03/2021		
	Gross	Tax	Net	Gross	Tax	Net
<b>(i) Items that will not be reclassified to Statement of Profit and Loss</b>						
Remeasurement of Defined Benefit Obligation (refer note - 31)	(5)	3	(2)	57	(20)	37
Change in Fair Value of Investment in Associates as FVTOCI	17	-	17	94	-	94
Change in Fair Value of Equity Instruments as FVTOCI	1,091	(234)	857	4,257	-	4,257
	<b>1,103</b>	<b>(231)</b>	<b>872</b>	<b>4,408</b>	<b>(20)</b>	<b>4,388</b>
<b>(ii) Items that will be reclassified to Statement of Profit and Loss</b>						
Change in Fair Value of Debt Instruments designated as FVTOCI	(9)	3	(6)	(9)	3	(6)
Effective portion of Cash Flow Hedges	(1,867)	653	(1,214)	(757)	264	(493)
Cost of Hedging Reserve	(75)	26	(49)	(168)	59	(109)
	<b>(1,951)</b>	<b>682</b>	<b>(1,269)</b>	<b>(934)</b>	<b>326</b>	<b>(608)</b>
<b>Total Other Comprehensive Income/ (Loss)</b>	<b>(848)</b>	<b>451</b>	<b>(397)</b>	<b>3,474</b>	<b>306</b>	<b>3,780</b>



# Notes

forming part of the Standalone Financial Statements

## 40. Earnings per Share (EPS)

	(₹ in Crore)	
	Year ended	
	31/03/2022	31/03/2021
Profit/ (Loss) attributable to Equity Shareholders	5,507	993
<b>Weighted average numbers of equity shares for calculation of EPS:</b>		
Weighted-average numbers of equity shares for Basic EPS	2,224,071,351	2,224,224,042
Dilutive impact of Employee Stock Option Scheme	2,968,669	1,172,360
Weighted-average numbers of equity shares for Diluted EPS	2,227,040,020	2,225,396,402
Face Value per Equity Share (₹)	1.00	1.00
Earnings per Share		
Basic (₹)	24.76	4.46
Diluted (₹)	24.73	4.46

Treasury shares are excluded from weighted-average numbers of equity shares used as a denominator in the calculation of EPS.

Stock options granted to the employees under various ESOP schemes are considered to be potential equity shares. They have been included in the determination of diluted earnings per share to the extent they are dilutive. 538,978 shares (year ended 31/03/2021 4,295,432 Shares) options granted under Employee Stock option scheme but were not included in the calculation of diluted earnings per share because they are antidilutive for the period. Options can potentially dilute basic earnings per share in the future depending on future share price of the Company. The stock options have not been included in the determination of basic earnings per share. For details relating to stock options, refer note 42.

## 41. Segment Reporting

The Company has presented segment information in its Consolidated Financial Statements, which are part of the same annual report. Accordingly, in terms of provisions of Accounting Standard on Segment Reporting (Ind AS 108), no disclosure related to the segment are presented in the Standalone Financial Statements.

## 42. Employee Share-based Payments

Refer Note 1B (V) for accounting policy on Employee Share-based Payments

The Company has formulated employee share-based payment schemes with the objective to attract and retain talent and align the interest of employees with the Company as well as to motivate them to contribute to its growth and profitability. The Company views employee stock options as instruments that would enable the employees to share the value they create for the Company in the years to come. At present, following employee share-based payment schemes are in operation, details of which are given below:

### (I) Employee Stock Option Scheme 2006 ("ESOS 2006"):

The shareholders of the Company has approved on 23/01/2007 an Employee Stock Option Scheme 2006 ("ESOS 2006"), under which the Company may grant up to 3,475,000 stock options to its permanent employees in the management cadre, whether working in India or out of India, including Managing and the Whole Time Directors of the Company, in one or more tranches. The ESOS 2006 is administered by the Nomination and Remuneration Committee of the Board of Directors of the Company ("the Committee"). Each stock option, when exercised, would be converted into one fully paid-up equity share of ₹ 1/- each of the Company. The stock options will vest in 4 equal annual instalments after completion of one year of service from the date of grant. The exercise price shall be average price of the equity shares of the Company in the immediate preceding seven day period on the date prior to the date on which the ESOS compensation committee

finalises the specific numbers of Options to be granted to the employees discounted by such percentage not exceeding 30 % (thirty percent) to be determined by ESOS Compensation Committee in the best interest of the various stake holders in the prevailing market conditions. The maximum period of exercise is 5 years from the date of vesting and these stock options do not carry rights to dividends or voting rights till the date of exercise. Further, forfeited/ expired stock options are also available for grant. Further, on 23/09/2011 the ESOS 2006 has been partially modified and by which the Company may grant 6,475,000 stock options to its eligible employees.

Under the ESOS 2006, till 31/03/2022 the Committee has granted 4,328,159 stock options (31/03/2021: 4,328,159 stock options) to its eligible employees out of which 1,819,941 stock options (31/03/2021: 1,819,941 stock options) has been forfeited/ expired and are available for grant as per term of the Scheme.

A summary of movement of the stock options and weighted average exercise price (WAEP) is given below:

	(₹ in Crore)			
	As at			
	31/03/2022		31/03/2021	
	Number	WAEP	Number	WAEP
Outstanding at beginning of the year	391,304	118.73	456,956	118.73
Granted during the year	-	-	-	-
Forfeited during the year	-	-	-	-
Exercised during the year	(391,304)	118.73	(65,652)	118.73
Expired during the year	-	-	-	-
Outstanding at year end	-	-	391,304	118.73
Vested and Exercisable at year end	-	-	391,304	118.73

Under ESOS 2006, as at 31/03/2022 exercise prices for stock options outstanding was Nil (31/03/2021: ₹ 118.73) whereas the weighted average remaining contractual life of the stock options outstanding was Nil (31/03/2021: 1.02 years).

The weighted average share price at the date of exercise of ESOS 2006 was ₹ 428.07 per share (31/03/2021 ₹ 173.25 per share).

### (II) Employee Stock Option Scheme 2013 ("ESOS 2013"):

The shareholders of the Company has approved on 10/09/2013 an Employee Stock Option Scheme 2013 ("ESOS 2013"), under which the Company may grant up to 5,462,000 Options (comprising of Stock Options and/ or Restricted Stock Units (RSU)) to the permanent employees in the management cadre and Managing and Whole time Directors of the Company and its subsidiary companies in India and abroad, in one or more tranches. The ESOS 2013 is administered by the Nomination and Remuneration Committee of the Board of Directors of the Company ("the Committee"). The stock options exercise price would be determined by the Committee, whereas the RSUs exercise price shall be the face value of the equity shares of the Company as at the date of grant of RSUs. Each stock option and each RSU entitles the holders to apply for and be allotted one fully paid-up equity share of ₹ 1/- each of the Company upon payment of exercise price during exercise period. The stock options will vest in 4 equal annual instalments after completion of one year of the services from the date of grant, whereas RSU will vest upon completion of three years of services from the date of grant. The maximum period of exercise is 5 years from the date of vesting and these stock option/ RSU do not carry rights to dividends or voting rights till the date of exercise. Further, forfeited/ expired stock options and RSUs are also available for grant.

In terms of ESOS 2013, till 31/03/2022 the Committee has granted 2,250,754 stock options and 2,252,254 RSUs (31/03/2021: 2,250,754 stock options and 2,252,254 RSUs) to the eligible employees of the Company and some of its subsidiary companies. Further, 301,381 stock options and 213,095 RSUs (31/03/2021: 296,996 stock options and 202,063 RSUs) has been forfeited/ expired and are available for grant as per term of the Scheme.

# Notes

forming part of the Standalone Financial Statements

A summary of movement of stock options and RSUs and weighted average exercise price (WAEP) is given below:

	As at							
	31/03/2022				31/03/2021			
	Stock Options		RSUs		Stock Options		RSUs	
	Number	WAEP	Number	WAEP	Number	WAEP	Number	WAEP
Outstanding at beginning of the year	110,700	132.68	55,691	1.00	415,944	124.82	235,718	1.00
Granted during the year	-	-	-	-	-	-	-	-
Re-instated during the year	-	-	-	-	-	-	-	-
Forfeited during the year	-	-	-	-	(37,086)	144.19	(8,776)	1.00
Exercised during the year	(80,067)	132.52	(17,106)	1.00	(224,657)	119.02	(171,251)	1.00
Expired during the year	(4,385)	119.45	(11,032)	1.00	(43,501)	119.45	-	-
Outstanding at year end	26,248	135.39	27,553	1.00	110,700	132.68	55,691	1.00
Vested and Exercisable at year end	26,248	135.39	27,553	1.00	110,700	132.68	55,691	1.00

Under ESOS 2013, the range of exercise prices for stock options outstanding as at 31/03/2022 was ₹ 119.45 to ₹ 167.15 (31/03/2021: ₹ 119.45 to ₹ 167.15) whereas exercise price in case of RSUs was ₹ 1.00 (31/03/2021: ₹ 1.00). The weighted average remaining contractual life for the stock options and RSUs outstanding as at 31/03/2022 was 1.09 years and 2.73 years, respectively (31/03/2021: 1.51 years and 2.54 years, respectively).

The weighted average share price at the date of exercise of ESOS 2013 was ₹ 460.52 per share (31/03/2021 ₹ 220.69 per share).

### (III) Employee Stock Option Scheme 2018 ("ESOS 2018"):

The shareholders of the Company has approved on 21/09/2018 an Employee Stock Option Scheme 2018 ("ESOS 2018"), formulated by the Company, under which the Company may grant not more than 13,957,302 [Stock Options and Restricted Stock Units('RSU')] to its permanent employees of the Company in management cadre including Managing and the Wholtime Director of the Company and its subsidiary companies in India and abroad, in one or more tranches. The ESOS 2018 is administered by the Nomination and Remuneration Committee of the Board of Directors of the Company ("the Committee") and the Hindalco Employees Welfare Trust ("Trust"). The Stock options exercise price would be determined by the Committee whereas the RSU exercise price shall be the face value of the equity shares of the Company as at the date of grant of RSUs. Each stock option and each RSU entitles the holders to apply for and be allotted one fully paid-up equity share of Re. 1/- each of the Company upon payment of exercise price during the exercise period. The stock options will vest in 4 equal annual instalments after completion of one year of the services from the date of grant, whereas RSU will vest upon completion of three years of services from the date of grant. The maximum period of exercise is 5 years from the date of vesting and these stock options/RSUs do not carry rights to dividends or voting rights till the date of exercise. Further, forfeited/expired stock options and RSUs are also available for grant.

In terms of ESOS 2018, till 31/03/2022 the Committee has granted 7,062,503 stock options and 1,981,539 RSUs (31/03/2021: 5,189,519 stock options and 1,368,979 RSUs) to the eligible employees of the Company and some of its subsidiary companies. A summary of movement of stock options and RSUs and weighted average exercise price (WAEP) is given below:

	As at							
	31/03/2022				31/03/2021			
	Stock Options		RSUs		Stock Options		RSUs	
	Number	WAEP	Number	WAEP	Number	WAEP	Number	WAEP
Outstanding at beginning of the year	4,277,702	226.06	1,279,318	1.00	4,448,494	217.95	1,297,506	1.00
Granted during the year	1,872,984	448.89	612,560	1.00	582,240	278.05	20,487	1.00
Re-instated during the year	17,719	278.05	-	-	-	-	-	-
Forfeited during the year	(155,816)	306.39	(59,936)	1.00	(692,325)	218.31	(38,675)	1.00
Exercised during the year	(687,701)	224.10	(191,267)	1.00	(60,707)	218.80	-	-
Expired during the year	-	-	-	-	-	-	-	-
Outstanding at year end	5,324,888	302.51	966,695	1.00	4,277,702	226.06	1,279,318	1.00
Vested and Exercisable at year end	2,370,953	228.84	966,695	1.00	1,565,967	218.60	46,058	1.00

Under ESOS 2018, the range of exercise prices for stock options outstanding as at 31/03/2022 was ₹ 159.30 to ₹ 453.95 (31/03/2021 was ₹ 159.30 to ₹ 278.05) whereas exercise price in case of RSUs was ₹ 1 (31/03/2021: ₹ 1.00). The weighted average remaining contractual life for the stock options and RSUs outstanding as at 31/03/2022 was 5.29 years and 5.50 years, respectively (31/03/2021 was 5.43 years and 5.84 years respectively).

The weighted average share price at the date of exercise of ESOS 2018 was ₹ 509.37 per share (31/03/2021 was ₹ 332.87 per share).

The fair values at grant date of stock options granted during the year ended 31/03/2022 was ₹ 176.04 to ₹ 220.36 (31/03/2021 was ₹ 144.57 to ₹ 181.09) and fair values in case of RSUs was ₹ 419.15 to ₹ 435.62 (31/03/2021 was ₹ 269.56), respectively. The fair valuation has been carried out by an independent valuer by applying Black and Scholes Model. The inputs to the model include the exercise price, the term of option, the share price at grant date and the expected volatility, expected dividends and the risk free rate of interest for terms of options.

The details of options granted, the key assumptions for Fair Value on the date of grant are as under :

	FY 2021-22			
	Tranche VII		Tranche VIII	
	Stock Option	RSU	Stock Option	RSU
Grant date	06/08/2021	06/08/2021	12/11/2021	12/11/2021
Exercise price (₹ )	443.25	1.00	453.95	1.00
Expected terms of options granted (years)	4.43 to 6.43 years	6 years to 8 years	4.43 to 6.43 years	6 years to 8 years
Share price on grant date (₹ )	443.10	443.10	453.95	453.95
Expected volatility (%)	41.10%	41.10%	41.45%	41.45%
Expected dividend (%)	0.68%	0.68%	0.66%	0.66%
Risk free interest rate (%)	5.64% - 6.22%	6.12% - 6.54%	5.54% - 6.12%	6.01% - 6.44%

# Notes

forming part of the Standalone Financial Statements

	FY 2020-21		
	Tranche V		Tranche VI
	Stock Option	RSU	Stock Option
Grant date	10/02/2021	10/02/2021	10/02/2021
Exercise price (₹)	278.05	1.00	278.05
Expected terms of options granted (years)	4.43 to 7.43 years	8 years	4.43 years
Share price on grant date (₹)	279.40	279.40	279.40
Expected volatility (%)	59.50%	59.50%	59.50%
Expected dividend (%)	0.36%	0.36%	0.36%
Risk free interest rate (%)	5.46% - 6.17%	6.27%	5.46%

The expected volatility was determined based on the historical share price volatility over the past period depending on life of the options granted which is indicative of future periods and which may not necessarily be the actual outcome.

#### (IV) Stock Appreciation Rights ('SAR 2018'):

The Company till 31/03/2022, has granted 156,694 Option SAR and 50,665 RSU SAR (31/03/2021: 95,815 Option SAR and 20,514 RSU SAR) under the Share Appreciation Rights Scheme 2018 ("SAR 2018") to its eligible employees. Option SAR to be vested in 4 equal annual instalments after completion of one year of the service from the date of grant and RSU SAR will vest upon completion of three years of services from the date of grant. The SAR 2018 is administered by the Nomination and Remuneration Committee of the Board of Directors of the Company ("the Committee"). The SAR 2018 have performance linked vesting conditions which are decided by the committee and are cash settled. The options shall lapse in case of performance linked vesting conditions are not met. The range of exercise price of the Option SAR is ₹ 159.30 to ₹ 443.25 and RSU SAR is ₹ 1 (31/03/2021: Option SAR is ₹ 159.30 to ₹ 278.05 and RSU SAR is ₹ 1).

A summary of movement of SAR and weighted average exercise price (WAEP) is given below:

	As at 31/03/2022				As at 31/03/2021			
	Option SAR		RSU SAR		Option SAR		RSU SAR	
	Number	WAEP	Number	WAEP	Number	WAEP	Number	WAEP
Outstanding at beginning of the year	76,652	215.00	20,514	1.00	44,668	218.80	11,333	1.00
Granted during the year	60,879	255.50	30,151	1.00	51,147	203.79	9,181	1.00
Forfeited during the year	-	-	-	(19,163)	193.97	-	-	-
Exercised during the year	(39,604)	223.29	(20,669)	1.00	-	-	-	-
Expired during the year	-	-	-	-	-	-	-	-
Outstanding at year end	97,927	236.82	29,996	1.00	76,652	215.00	20,514	1.00
Vested and Exercisable at year end	47,115	218.80	13,565	-	11,167	218.80	-	-

The fair values per Option SAR as at 31/03/2022 was ₹ 248.38 to ₹ 440.84 (31/03/2021 ₹ 144.97 to ₹ 232.47) and for RSU SAR as at 31/03/2022 was ₹ 552.96 to ₹ 560.60 (31/03/2021 ₹ 321.21 to ₹ 322.35). The fair value has been carried out by an independent valuer by applying Black and Scholes Model. The inputs to the model include the exercise price, the term of option, the share price at grant date and the expected volatility, expected dividends and the risk free rate of interest. The assumptions used for fair valuation for Option SAR and RSU SAR are given below:

	Year ended					
	31/03/2022					
Grant date	26/03/2019	09/08/2019	12/06/2020	12/06/2020	10/02/2021	06/08/2021
Valuation Date	31/03/2022	31/03/2022	31/03/2022	31/03/2022	31/03/2022	31/03/2022
Exercise price (₹)	1.00	218.80	159.30	1.00	278.05	218.80
Expected volatility (%)	40.05%	40.05%	40.05%	40.05%	40.05%	40.05%
Expected dividend (%)	0.53%	0.53%	0.53%	0.53%	0.53%	0.53%
Risk Free interest rate (%)	5.40%	5.72%	5.37% - 6.18%	5.40% - 5.82%	5.34%	5.72%

	Year ended					
	31/03/2022					
Grant date	06/08/2021	06/08/2021	12/11/2021	12/11/2021	12/11/2021	12/11/2021
Valuation Date	31/03/2022	31/03/2022	31/03/2022	31/03/2022	31/03/2022	31/03/2022
Exercise price (₹)	278.05	1.00	218.80	278.05	443.25	1.00
Expected volatility (%)	40.05%	40.05%	40.05%	40.05%	40.05%	40.05%
Expected dividend (%)	0.53%	0.53%	0.53%	0.53%	0.53%	0.53%
Risk Free interest rate (%)	5.34%	5.40% - 5.57%	5.26% - 5.72%	5.34%	5.57% - 6.30%	5.26% - 6.30%

	Year ended					
	31/03/2021					
Grant date	26/03/2019	09/08/2019	09/08/2019	12/06/2020	12/06/2020	10/02/2021
Valuation Date	31/03/2021	31/03/2021	31/03/2021	31/03/2021	31/03/2021	31/03/2021
Exercise price (₹)	1.00	218.80	1.00	159.30	1.00	278.05
Expected volatility (%)	50.90%	50.90%	50.90%	50.90%	50.90%	50.90%
Expected dividend (%)	0.31%	0.31%	0.31%	0.31%	0.31%	0.31%
Risk Free interest rate (%)	5.45%	4.27% - 5.70%	5.34%	5.43% - 6.05%	5.45% - 5.78%	5.41%

The weighted average remaining contractual life for the Option SAR as at 31/03/2022 is 2.70 to 5.35 years (31/03/2021: 1.69 to 5.92 years) and RSU SAR as at 31/03/2022 is 2.70 to 5.35 years (31/03/2021: 3.70 to 4.92 years).

The total intrinsic value at the end of the year of the vested Option SAR and RSU SAR is ₹ 2.42 crore (31/03/2021 ₹ 0.12 crore).

#### Effect of Employee Share-Based Payment transactions on Profit or Loss for the period and on financial position:

For the year ended 31/03/2022, the Company recognised total expenses of ₹ 40 crore (31/03/2021 ₹ 16 crore) related to equity-settled and cash-settled share based transactions. During the year ended 31/03/2022, the Company has allotted fully paid-up 488,477 equity share of ₹ 1/- each of the Company (31/03/2021 461,560) on exercise of equity settled options for which the Company has realised ₹ 6 crore (31/03/2021 ₹ 3 crore) as exercise prices.

The Company has received ₹ 0.70 crore (31/03/2021 ₹ 0.29 crore) from Utkal Alumina International Limited and Hindalco - Almex Aerospace Limited (Subsidiaries) towards the grant of 91,611 Stock Options and 49,061 RSUs (31/03/2021: 88,676 Stock Options and 43,261 RSUs) under ESOS 2018 which is netted off from Employee Share-Based Payments Expenses.



# Notes

forming part of the Standalone Financial Statements

## 43. Related party disclosures

### (A) List of Related Parties where control exists:

Name of the Related Party	Principal Place of Business
<b>(a) Subsidiary Companies:</b>	
1 Minerals & Minerals Limited	India
2 Renukeshwar Investments & Finance Limited	India
3 Renuka Investments & Finance Limited	India
4 Lucknow Finance Company Limited	India
5 Dahej Harbour and Infrastructure Limited	India
6 Utkal Alumina International Limited	India
7 Utkal Alumina Social Welfare Foundation	India
8 Kosala Livelihood And Social Foundation	India
9 Birla Copper Asoj Private Limited (formerly known as "Ryker Base Private Limited") - (h)	India
10 Suvas Holdings Limited	India
11 Hindalco-Almex Aerospace Limited	India
12 East Coast Bauxite Mining Company Private Limited	India
13 AV Minerals (Netherlands) N.V.	Netherland
14 Hindalco Do Brasil Industria Comercia de Alumina Ltda.	Brazil
15 AV Metals Inc.	Canada
16 Novelis Inc.	Canada
17 Novelis do Brasil Ltda.	Brazil
18 Brecha Energetica Ltda.	Brazil
19 4260848 Canada Inc.	Canada
20 4260856 Canada Inc.	Canada
21 8018227 Canada Inc.	Canada
22 Novelis (China) Aluminum Products Co., Ltd.	China
23 Novelis (Shanghai) Aluminum Trading Co., Ltd.	China
24 Novelis PAE SAS	France
25 Novelis Aluminium Beteiligungs GmbH	Germany
26 Novelis Deutschland GmbH (formerly known as "Aleris Deutschland Holding GmbH")	Germany
27 Novelis Sheet Ingot GmbH	Germany
28 Novelis (India) Infotech Ltd.	India
29 Novelis Aluminum Holding Unlimited Company	Ireland
30 Novelis Italia SpA	Italy
31 Novelis de Mexico S.A. de C.V.	Mexico
32 Novelis Korea Limited	South Korea

Name of the Related Party	Principal Place of Business
33 Novelis AG	Switzerland
34 Novelis Switzerland S.A.	Switzerland
35 Novelis MEA Ltd.	United Arab Emirates
36 Novelis Europe Holdings Limited	United Kingdom
37 Novelis UK Ltd.	United Kingdom
38 Novelis Services Limited	United Kingdom
39 Novelis Corporation	United States of America
40 Novelis South America Holdings LLC	United States of America
41 Novelis Holdings Inc.	United States of America
42 Novelis Services (North America) Inc.	United States of America
43 Novelis Global Employment Organization, Inc.	United States of America
44 Novelis Services (Europe) Inc.	United States of America
45 Novelis Vietnam Company Limited	Vietnam
46 Aleris Asia Pacific International (Barbados) Ltd.	Barbados
47 Aleris Aluminum (Zhenjiang) Co., Ltd.	China
48 Aleris (Shanghai) Trading Co., Ltd.	China
49 Aleris Asia Pacific Limited	Hong Kong
50 Aleris Aluminum Japan, Ltd.	Japan
51 Novelis Casthouse Germany GmbH (formerly known as "Aleris Casthouse Germany GmbH")	Germany
52 Novelis Deutschland Holding GmbH	Germany
53 Novelis Koblenz GmbH (formerly known as "Aleris Rolled Products Germany GmbH")	Germany
54 Novelis Netherlands B.V.(formerly known as "Novelis Aluminum Netherlands B.V.")	Netherlands
55 Aleris Switzerland GmbH	Switzerland
56 Aleris Aluminum UK Limited	United Kingdom
57 Aleris Holding Canada ULC	Canada
58 Novelis ALR Aluminum Holdings Corporation (formerly known as "Aleris Corporation")	United States of America
59 Novelis ALR International, Inc. (formerly known as "Aleris International, Inc.")	United States of America
60 Novelis ALR Rolled Products, LLC (formerly known as "Aleris Rolled Products,LLC")	United States of America
61 Novelis ALR Rolled Products, Inc. (formerly known as "Aleris Rolled Products, Inc.")	United States of America
62 Novelis ALR Aluminum, LLC (formerly known as "Nichols Aluminum LLC")	United States of America
63 Novelis ALR Rolled Products Sales Corporation (formerly known as "Aleris Rolled Products SalesCorporation")	United States of America
64 Novelis ALR Recycling of Ohio, LLC (formerly known as "IMCO Recycling of Ohio, LLC")	United States of America
65 Novelis ALR Aluminum-Alabama, LLC (formerly known as "Nichols Aluminum-Alabama LLC")	United States of America
66 Novelis ALR Asset Management Corporation (formerly known as "UWA Acquisition Co.")	United States of America

# Notes

forming part of the Standalone Financial Statements

## (b) Trust Controlled by the Company

1	Hindalco Jan Seva Trust	India
2	Copper Jan Seva Trust	India
3	Utkal Alumina Jan Seva Trust	India

## During the year ended March 31, 2022:

- Saras Micro Devices, Inc. was formed on April 21, 2021
- Aleris RM, Inc. and Name Acquisition Co. - Merged into Aleris International, Inc. on July 21, 2021
- 90% stake in Saras Micro Devices, Inc. was sold on November 22, 2021
- Aleris Aluminum France SAS merged into Novelis PAE SAS on March 29, 2022
- Novelis Laminés France SAS merged into Novelis PAE SAS on March 29, 2022
- Aleris Aluminum Poland Sp. z.o.o. dissolved by operation of law into Aleris Switzerland GmbH on April 15, 2021
- 100% stake in Hindalco Do Brasil Industria Comercia de Alumina Ltda. was sold on March 7, 2022
- 100% equity stake in Birla Copper Asoj Private Limited (formerly known as Ryker Base Private Limited) was acquired on November 18, 2021 through wholly owned subsidiary, Renuka Investments and Finance Limited.

## (B) List of Related Parties with joint control and significant influence:

Name of the Related Party	Principal Place of Business
<b>(a) Joint Ventures (Joint Control):</b>	
1 MNH Shakti Limited	India
2 Hydromine Global Minerals (GMBH) Limited (Hydromine)	British Virgin Islands
<b>(b) Associates (Significant Influence):</b>	
1 Aditya Birla Science & Technology Company Private Limited	India
2 Aditya Birla Renewable Subsidiary Limited	India
3 Aditya Birla Renewables Solar Limited	India
4 Aditya Birla Renewable Utkal Limited	India
5 Deutsche Aluminum Verpackung Recycling GMBH	Germany
6 France Aluminum Recyclage SPA.	France

## (C) Key Managerial Personnel

Relationship	
1 Mr. Satish Pai - Managing Director	Executive Directors
2 Mr. Praveen Maheshwari -Whole time Director & Chief Financial Officer	Executive Directors
3 Mr. Kumar Mangalam Birla	Non Executive Directors
4 Smt. Rajashree Birla	Non Executive Directors
5 Mr D Bhattacharya (Resigned w.e.f. 2nd March, 2022)	Non Executive Directors
6 Mr. A.K.Agarwala	Non Executive Directors
7 Mr. K.N. Bhandari	Non Executive Directors
8 Mr. Y.P. Dandiwal	Non Executive Directors

Name of the Related Party	Principal Place of Business
9 Mr. Anant Maheshwari	Non Executive Directors
10 Ms. Alka Bharucha	Non Executive Directors
11 Dr. Vikas Balia	Non Executive Directors
12 Mr. Sudhir Mital	Non Executive Directors

## (D) Other Related Parties with whom there were transactions during the year:

Relationship	
1 Hindalco Employee's Gratuity Fund, Kolkata	Post-Employment Benefit Plan
2 Hindalco Employee's Gratuity Fund, Renukoot	Post-Employment Benefit Plan
3 Hindalco Employee's Provident Fund Institution, Renukoot	Post-Employment Benefit Plan
4 Hindalco Superannuation Scheme, Renukoot	Post-Employment Benefit Plan
5 Hindalco Industries Limited Employees' Provident Fund II	Post-Employment Benefit Plan
6 Hindalco Industries Limited Senior Management Staff Pension Fund II	Post-Employment Benefit Plan
7 Aditya Birla Management Corporation Private Limited (ABMCPL) @	Other related party in which Director is interested

@ The Company is a member of Aditya Birla Management Corporation Private Limited (ABMCPL), a company limited by guarantee formed for the purpose of its members to mutually avail and share common facilities, expertise and other support charged on cost basis.

## (E) The following transactions were carried out with the related parties in the ordinary course of business

Nature of Transaction/Relationship	Note No.	Year Ended	
		31/03/2022	31/03/2021
<b>Sale of Goods</b>	<b>26</b>	<b>86</b>	<b>50</b>
Subsidiaries		86	50
<b>Services rendered</b>	<b>26</b>	<b>12</b>	<b>9</b>
Subsidiaries		1	1
Associates		-	-
Other related party in which Director is interested		11	8
<b>Interest received during the year</b>	<b>27</b>	<b>8</b>	<b>3</b>
Subsidiaries		6	1
Associates		2	2
<b>Dividend received during the year</b>	<b>27</b>	<b>1</b>	<b>1</b>
Subsidiaries		-	1
Associates		1	-
<b>Contribution to</b>		<b>218</b>	<b>218</b>
Post-Employment Benefit Plan		213	208
Trust Controlled by the Company		5	10
<b>Interest paid</b>	<b>33</b>	<b>-</b>	<b>-</b>
Subsidiaries		-	-
<b>Purchase of Materials, Capital Equipment and Others</b>		<b>3,628</b>	<b>2,785</b>
Subsidiaries**		3,606	2,768
Associates		22	17

## Notes

forming part of the Standalone Financial Statements

Nature of Transaction/Relationship	Note No.	Year Ended	
		₹ in Crore	
		31/03/2022	31/03/2021
<b>Services received</b>		<b>620</b>	<b>431</b>
Subsidiaries		45	27
Associates		16	14
Other related party in which Director is interested		559	390
<b>Investments, Loans and Deposits made during the year</b>	<b>5 to 10</b>	<b>235</b>	<b>2</b>
Subsidiaries		227	2
Associates		8	-
Joint Ventures		-	-
<b>Investments, Loans and Deposits made returned back during the year by</b>	<b>5 to 10</b>	<b>608</b>	<b>8</b>
Subsidiaries <sup>1</sup>		595	3
Associates		5	5
Joint Ventures		8	-
<b>Investments, Deposits, Loans and Advances obtained during the year from</b>		<b>1,000</b>	<b>-</b>
Subsidiary ~		1,000	-
<b>Investments, Deposits, Loans and Advances repaid during the year to</b>		<b>1,000</b>	<b>-</b>
Subsidiary ~		1,000	-
<b>Licence and Lease agreements</b>		<b>-</b>	<b>-</b>
Subsidiaries		-	-
<b>Recovery of ESOP Expenses</b>	<b>31</b>	<b>1</b>	<b>-</b>
Subsidiaries		1	-

### (F) Outstanding balances: #

Nature of Transaction/Relationship	Note No.	Year Ended	
		₹ in Crore	
		31/03/2022	31/03/2021
<b>Receivables and Advances</b>	<b>10, 12</b>	<b>109</b>	<b>106</b>
Subsidiaries		17	16
Other related party in which Director is interested		88	89
Trust Controlled by the Company		4	1
<b>Payables</b>	<b>20</b>	<b>507</b>	<b>312</b>
Subsidiaries <sup>^</sup>		435	281
Associates		2	1
Other related party in which Director is interested		70	30
Trust Controlled by the Company		-	-
<b>Loans and Deposits (Given)</b>	<b>8, 9A, 9B</b>	<b>205</b>	<b>49</b>
Subsidiaries		169	8
Associates		36	41
<b>Guarantees and Collateral Securities given</b>		<b>5</b>	<b>5</b>
Subsidiaries		5	5

# all outstanding balances are unsecured and are payable in cash.

\*\* Includes purchase of Alumina from Utkal Alumina International Limited amounting to ₹ 3553 crore (year ended 31/03/2021 ₹ 2722 crore).

<sup>^</sup> Includes amount payable to Utkal Alumina International Limited amounting to ₹ 422 crore (year ended 31/03/2021 ₹ 274 crore).

~ represents loan obtained from and repaid to Utkal Alumina International Limited.

<sup>1</sup> Includes return of capital from AV Minerals (Netherlands) N.V. amounting to ₹ 557 crore (year ended 31/03/2021: Nil) including Foreign Currency Exchange gain of ₹ 160 crore.

### (G) Compensation of Key Managerial Personnel (KMP) of the Company:

	Year ended	
	₹ in Crore	
	31/03/2022	31/03/2021
<b>(a) Remuneration of Executive Directors - (i) and (ii)</b>	<b>53</b>	<b>29</b>
Short term employment benefit	51	27
Post employment benefits	2	2
<b>(b) Remuneration to erstwhile Managing Director - (iii)</b>	<b>3</b>	<b>3</b>
Post-employment benefits	3	3
<b>(c) Remuneration of Non - Executive Directors</b>	<b>7</b>	<b>6</b>
Commission & Sitting Fees	7	6

- (i) Excludes amortisation of fair value of employee share-based payments under Ind AS 102.
- (ii) As the liabilities for defined benefit plans and leave entitlements are provided on actuarial basis for the Company as a whole, the amounts pertaining to Key Management Personnel are not included.
- (iii) The Board approved pension of Mr. D. Bhattacharya of ₹ 0.335 crore per month and other post-employment benefits for his past service when he was the Managing Director of the Company. The present value of the above pension liability determined based on the actuarial valuation is accounted by the Company in the financial statements. Amount charged as expenses in the statement of profit and loss during the year towards such post-employment benefit amounting to ₹ 3 crore (as at 31/03/2021 ₹ 3 crore) has been disclosed as a part of managerial remuneration above, and does not include the impact of actuarial (gains)/losses recognised in other comprehensive income.

## 44. Contingent Liabilities and Commitments

Refer Note 1B (K) for accounting policy on Provisions and contingencies

The Company is party to, and may in the future be involved in, or subject to, disputes, claims and proceedings arising in the ordinary course of our business, including some we assert against others, such as environmental, health and safety, product liability, employee, tax, personal injury and other matters. The Company has established a liability with respect to contingencies for which a loss is probable and estimable. While the ultimate resolution of liability and costs related to these matters cannot be determined with certainty, the Management does not believe any of these pending actions, individually or in the aggregate, will materially impact our operations or materially affect our financial condition or liquidity. The Company's estimates involve significant judgment, and therefore, the estimate will change from time to time and actual losses may differ from the current estimate.

Management reviews the status of, and estimated liability related to, pending claims and civil actions on a quarterly basis. The evaluation model includes all asserted and unasserted claims that can be reasonably identified including claims relating to our responsibility for compliance with environmental, health and safety laws and regulations. The estimated costs in respect of such reported liabilities are not offset by amounts related to insurance or indemnification arrangements unless otherwise noted.



# Notes

forming part of the Standalone Financial Statements

	(₹ in Crore)	
	As at	
	31/03/2022	31/03/2021
<b>A. Contingent Liabilities</b>		
<b>(a) Claims against Company not acknowledged as Debt:</b>		
(i) Demand for Stamp Duty by Collector (Stamp), Kanpur, Uttar Pradesh (U.P.) on merger of Copper Business of IndoGulf Corporation with the Company. The matter is pending before the Hon'ble High Court of Allahabad. The Company believes that there is no substantive/computation provision for levy/calculation of stamp duty within the provisions of Uttar Pradesh Stamp Act on scheme of arrangement under the Companies Act, 1956, approved by the Court. Moreover, the properties in question are located in the State of Gujarat and, thus, the Collector (Stamp), Kanpur, has no territorial jurisdiction to make such a demand. Further, the Company has already paid the stamp duty for the same in 2003-04 which has been accepted as per the provisions of the Bombay Stamp Act, 1958.	20	20
(ii) Demand towards drawal of energy during peak hours by Uttar Pradesh Power Corporation Limited (UPPCL)/ Purvanchal Vidyut Vitran Nigam Limited (PVVNL). The dispute relates to the agreement entered with UPPCL for the period 2009-14. Demand was raised by UPPCL for drawl of banked energy during peak hours. The Hon'ble Supreme Court has stayed the demand and the matter is pending with Appellate Tribunal for Electricity (APTEL).	81	81
(iii) Retrospective revision of Water Rates by UP Jal Vidyut Nigam Limited. Writ petition pending with Lucknow Bench of Allahabad High Court. The demand for arrears stayed.	4	4
(iv) Demand for Entry Tax relating to valuation dispute. Appeals have been filed with Additional CCT, Sambalpur.	28	28
(v) Interest demand on withholding of 50% payment of Entry tax. Appeal is pending before Hon'ble High Court of Odisha and stay has been granted.	27	27
(vi) Demand from State and Central Sales Tax authorities for various years at different levels of appeal.	26	26
(vii) Disallowances of Cenvat Credit on inputs & Capital goods & short payment of excise on additional consideration received from recipient of deemed exporter. Matters are pending with CESTAT.	9	9
(viii) Disallowances of Service Tax credit on Input services at Various locations. These matters are pending with CESTAT authorities.	104	101
(ix) Demand for recovery of cenvat credit availed on service tax paid on Goods Transport Agency (outward charges). The matter is pending with Commissioner (Appeals), Vadodara & Commissioner, Bharuch.	9	9
(x) Green Cess Provision Under Electricity Act Year-2012-13 to Year 2017-18. The matter is Pending at Hon'ble Supreme Court.	14	12
(xi) Transitional Credit of cess. Writ Petition filed before Odisha and MP High Court.	-	27
(xii) Penalty For Unauthorised Disposal Of Anode Butts. The matter is pending with Odisha High Court.	14	14
(xiii) Other Contingent Liabilities in respect of Excise, Customs, Sales Tax etc. each being for less than ₹ 1 crore. The demands are in dispute at various legal forums.	8	9
	<b>344</b>	<b>367</b>
It is not practicable for the Company to estimate the timings of cash outflows, if any, in respect of the above matters, pending resolution of the respective proceedings.		
<b>(b) Other money for which Company is contingently liable</b>		
(i) Customs Duty on Raw Materials imported under Advance License, against which export obligation is to be fulfilled.	24	-
<b>B. Commitments</b>		
<b>(a)</b> Estimated amount of contracts remaining to be executed on capital account and not provided for (net of advances)	1,073	635
<b>(b)</b> Other Commitment for purchase of goods and Services (Net of Advance)	3,100	21
<b>(c)</b> The Company has given the undertakings in connection with the loan of Utkal Aluminium International Limited (UAIL), a wholly owned subsidiary to hold minimum 51% equity shares in UAIL.		

## 45. Capital Management

The Company's objective to manage its capital is to ensure continuity of business while at the same time provide reasonable returns to its various stakeholders, but keep associated costs under control. In order to achieve this, requirement of capital is reviewed periodically with reference to operating and business plans that take into account capital expenditure and strategic investments. Apart from internal accrual, sourcing of capital is done through judicious combination of equity and borrowing, both short term and long term. Total debt (total borrowings + lease liabilities) to equity ratio is used to monitor capital. No changes were made to the objectives, policies or processes for managing capital during the years ended March 31, 2022 and March 31, 2021.

	(₹ in Crore)	
	As at	
	31/03/2022	31/03/2021
<b>Debt Equity Ratio</b>	0.36	0.40

As at March 31, 2022 and March 31, 2021, the Company was in compliance with all of its debt covenants for borrowings.

## 46. Offsetting Financial Liabilities and Financial Assets

Refer Note 1B (P) for accounting policy on Financial Instruments

Financial instruments subject to offsetting, enforceable master netting arrangement and similar arrangements.

As at 31/03/2022	Effects on Balance sheet			Related amounts not offset		
	Gross amount	Gross amount set off in the balance sheet	Net amount presented in the balance sheet	Amounts subject to master netting arrangements	Financial Instrument collateral	Net Amount
<b>Financial Assets</b>						
Derivatives	705	(24)	681	-	-	681
<b>Financial Liabilities</b>						
Derivatives	3,787	(24)	3,763	-	(345)	3,418

As at 31/03/2021	Effects on Balance sheet			Related amounts not offset		
	Gross amount	Gross amount set off in the balance sheet	Net amount presented in the balance sheet	Amounts subject to master netting arrangements	Financial Instrument collateral	Net Amount
<b>Financial Assets</b>						
Derivatives	800	(80)	720	-	-	720
<b>Financial Liabilities</b>						
Derivatives	2,025	(80)	1,945	-	(267)	1,678

# Notes

forming part of the Standalone Financial Statements

## 47. Financial Instruments

Refer Note 1B (P) for accounting policy on Financial Instruments

### A Fair Value Measurement

(a) The following table shows the carrying amounts of Financial Assets and Financial Liabilities by category:

(₹ in Crore)

	Note No.	As at					
		31/03/2022			31/03/2021		
		Amortised Cost	FVTOCI	FVTPL	Amortised Cost	FVTOCI	FVTPL
<b>Financial Assets</b>							
<b>Investments in Associate</b>							
Unquoted Instruments	6	-	154	-	-	128	-
<b>Investments in Equity Instruments</b>							
Quoted Equity Instruments*	7A & 7B	-	8,195	-	-	7,200	-
Unquoted Equity Instruments*	7A	-	15	-	-	20	-
<b>Investments in Debt Instruments</b>							
Mutual Funds	7A & 7B	-	-	4,335	-	-	7,026
Bonds and Debentures	7B	-	-	152	-	-	164
Government Securities	7A & 7B	-	375	-	-	385	-
<b>Loans</b>	8	217	-	-	60	-	-
<b>Trade receivables</b>	12	1,935	-	736	1,315	-	287
<b>Cash and Cash Equivalents</b>							
Cash and Bank	13	2,795	-	-	262	-	-
Liquid Mutual Funds	13	-	-	610	-	-	741
<b>Bank Balances other than cash &amp; cash equivalents</b>	14	3,015	-	-	16	-	-
<b>Derivatives</b>	49	-	-	681	-	-	720
<b>Other financial assets</b>	9A & 9B	1,388	-	-	442	-	-
		<b>9,350</b>	<b>8,739</b>	<b>6,514</b>	<b>2,095</b>	<b>7,733</b>	<b>8,938</b>

(₹ in Crore)

	Note No.	As at			
		31/03/2022		31/03/2021	
		Amortised Cost	FVTPL	Amortised Cost	FVTPL
<b>Financial Liabilities</b>					
<b>Borrowings</b>					
Borrowings, Non-Current	18A	11,668	-	9,177	-
Non convertible debentures (NCDs)	18B	5,999	-	5,997	-
Borrowings, Current	18B	1,412	-	4,755	-
<b>Lease Liabilities</b>	2	342	-	311	-
<b>Supplier's Credit</b>	19	2,456	-	255	-
<b>Trade Payables</b>	20	5,942	5,073	4,029	4,771
<b>Derivatives</b>	49	-	3,763	-	1,945
<b>Other financial Liabilities</b>	21A & 21B	1,013	-	947	-
		<b>28,832</b>	<b>8,836</b>	<b>25,471</b>	<b>6,716</b>

\* The Company had acquired certain equity instruments for purpose of holding for a longer duration and not for the purpose of selling in near term for short term profit. Such instruments have been categorized as FVTOCI.

(b) The following table shows the fair values of Financial Assets and Financial Liabilities measured at amortised cost:

(₹ in Crore)

	Note No.	As at			
		31/03/2022		31/03/2021	
		Carrying value	Fair Value	Carrying value	Fair Value
<b>Financial Assets</b>					
Loans	8	45	45	11	11
Other Financial Asset, Non Current	9A	232	232	188	188
		<b>277</b>	<b>277</b>	<b>199</b>	<b>199</b>

(₹ in Crore)

	Note No.	As at			
		31/03/2022		31/03/2021	
		Carrying value	Fair Value	Carrying value	Fair Value
<b>Financial Liabilities</b>					
<b>Borrowings</b>					
Non convertible debentures (NCDs)	18B	5,999	6,025	5,997	6,182
Long term Borrowings #	18A	11,676	11,778	9,642	9,718
Other Financial Liabilities, Non - Current	21A	13	13	10	10
		<b>17,688</b>	<b>17,816</b>	<b>15,649</b>	<b>15,910</b>

# Carrying amount includes current portion of long term borrowing shown under short term borrowing (Refer Note 18B).

Fair Value of borrowings does not include interest accrued but not due.

Fair values for current financial assets and financial liabilities have not been disclosed because their carrying amount are a reasonable approximation of their fair values.

(c) Classification of finance income and finance cost by instrument category

(₹ in Crore)

	Note No.	Year ended					
		31/03/2022			31/03/2021		
		Amortised Cost	FVTOCI	FVTPL	Amortised Cost	FVTOCI	FVTPL
<b>Income</b>							
Interest Income (i)	27	116	19	9	72	18	
Dividend Income (ii)	27	-	31	-	-	18	
		116	50	9	72	36	
<b>Expense</b>							
Interest Expense (iii)	33	1,330	-	-	1,419	-	
		<b>1,330</b>	<b>-</b>	<b>-</b>	<b>1,419</b>	<b>-</b>	

(₹ in Crore)

Details of amount not included in the table above	As at	
	31/03/2022	31/03/2021
(iii) Interest on Income Tax and other finance cost	87	50

For amortised cost and FVTOCI instruments, interest expense is recognised at effective interest rate.

# Notes

forming part of the Standalone Financial Statements

**(d) Derecognition of Investments in Equity Instruments designated at FVTOCI**

(₹ in Crore)

	Year ended			
	31/03/2022		31/03/2021	
	Fair value on the date of derecognition	Cumulative gain or (loss) on disposal	Fair value on the date of derecognition	Cumulative gain or (loss) on disposal
<b>Investment in Equity Instrument- Quoted</b>				
National Aluminium Company Limited	116	68	-	-
	116	68	-	-

**B Fair Value Hierarchy**

The following table shows the details of financial assets and financial liabilities including their levels in the fair value hierarchy:

**(a) Financial assets and financial liabilities measured at fair value - recurring fair value measurements:**

(₹ in Crore)

	Note No.	As at					
		31/03/2022			31/03/2021		
		Level 1	Level 2	Level 3	Level 1	Level 2	Level 3
<b>Financial Assets</b>							
<b>Investments in Associates</b>							
Unquoted Instruments	6	-	-	154	-	-	128
		-	-	154	-	-	128
<b>Investments in Equity Instruments</b>							
Quoted Equity Instruments	7A & 7B	8,195	-	-	7,200	-	-
Unquoted Equity Instruments	7A	-	-	15	-	-	20
		8,195	-	15	7,200	-	20
<b>Investments in Debt Instruments</b>							
Mutual Funds	7A & 7B	4,333	2	-	7,022	4	-
Bonds and Debentures	7B	-	-	152	-	77	87
Government Securities	7A & 7B	235	140	-	262	123	-
		4,568	142	152	7,284	204	87
Trade Receivables	12	-	736	-	-	287	-
<b>Cash and Cash Equivalents</b>							
Liquid Mutual Funds	13	610	-	-	741	-	-
Derivatives	49	-	681	-	-	720	-
		13,373	1,559	321	15,225	1,211	235
<b>Financial Liabilities</b>							
Trade Payables	20	-	5,073	-	4,771	-	-
Derivatives	49	-	3,763	-	1,945	-	-
		-	8,836	-	6,716	-	-

**(b) Fair value disclosure of Financial Assets and Financial Liabilities measured at amortised cost:**

(₹ in Crore)

	Note No.	As at					
		31/03/2022			31/03/2021		
		Level 1	Level 2	Level 3	Level 1	Level 2	Level 3
<b>Financial Liabilities</b>							
<b>Borrowings</b>							
Non convertible debentures (NCDs)	18B	-	6,025	-	-	6,182	-
Long term Borrowings	18A	-	11,778	-	-	9,718	-
Other Financial Liabilities, Non - Current	21A	-	13	-	-	10	-
		-	17,816	-	-	15,910	-

(₹ in Crore)

	Note No.	As at					
		31/03/2022			31/03/2021		
		Level 1	Level 2	Level 3	Level 1	Level 2	Level 3
<b>Financial Assets</b>							
Loans	8			45			11
Other Financial Asset, Non- Current	9A	-	-	232	-	-	188
		-	-	277	-	-	199

Level 1 Hierarchy includes financial instruments valued using quoted market prices. Listed equity instruments and traded debt instruments which are traded in the stock exchanges are valued using the closing price at the reporting date. Mutual funds are valued using the closing NAV.

Level 2 Hierarchy includes financial instruments that are not traded in active market. This includes over the counter (OTC) derivatives, close ended mutual funds and debt instruments valued using observable market data such as yield etc. of similar instruments traded in active market. All derivatives are reported at discounted values hence are included in level 2. Borrowings have been fair valued using credit adjusted interest rate prevailing on the reporting date. Trade Receivables and Payables that are realigned based on forward LME/LBMA price movements have been included in Level 2 hierarchy.

Level 3 If one or more significant inputs is not based on observable market data, the instrument is included in level 3. This is the case for unlisted equity instruments and certain debt instruments which are valued using assumptions from market participants.

**(iii) Disclosure of changes in level 3 items for the period ended 31/03/2022 and 31/03/2021 respectively**

(₹ in Crore)

	Unquoted Associates	Unquoted Equity Instruments	Unquoted Debt Instruments	Total
<b>As at 01/04/2020</b>	34	27	224	285
Acquisitions	-	-	-	-
Sale	-	-	(49)	(49)
Gain/(losses) recognised in Profit or loss	-	-	2	2
Gain/(losses) recognised in OCI	94	(7)	-	87
Transfer from Level 1 and 2	-	-	6	6
Transfer to Level 1 and 2	-	-	(96)	(96)



# Notes

forming part of the Standalone Financial Statements

	(₹ in Crore)			
	Unquoted Associates	Unquoted Equity Instruments	Unquoted Debt Instruments	Total
<b>As at 31/03/2021</b>	<b>128</b>	<b>20</b>	<b>87</b>	<b>235</b>
Acquisitions	8	-	-	8
Sale	-	-	(10)	(10)
Gain/(losses) recognised in Profit or loss	-	-	9	9
Gain/(losses) recognised in OCI	18	(5)	-	13
Transfer from Level 1 and 2	-	-	66	66
Transfer to Level 1 and 2	-	-	-	-
<b>As at 31/03/2022</b>	<b>154</b>	<b>15</b>	<b>152</b>	<b>321</b>
Unrealised Gain/(loss) recognised in profit and loss relating to assets and liabilities held at the end of reporting period:				
<b>As at 31/03/2022</b>	<b>-</b>	<b>-</b>	<b>9</b>	<b>9</b>
<b>As at 31/03/2021</b>	<b>-</b>	<b>-</b>	<b>5</b>	<b>5</b>

Transfers from level 1 and 2 to level 3 and out of level 3 for unquoted debt instruments is based on unavailability/availability of market observable inputs as on the reporting date. The Company's policy is to recognise transfers into and transfers out of fair value hierarchy levels as at the end of the reporting period.

**(iv) Sensitivity analysis of Level-3 Instruments:**

Increase/(Decrease) in Fair Value	(₹ in Crore)					
	Unquoted Associates		Unquoted Equity Instruments		Unquoted Debt Instruments	
	Impact on Statement of Profit and Loss Post Tax	Impact on OCI Post Tax	Impact on Statement of Profit and Loss Post Tax	Impact on OCI Post Tax	Impact on Statement of Profit and Loss Post Tax	Impact on OCI Post Tax
<b>Increase in Yield by 0.5%</b>						
<b>As at 31/03/2022</b>	-	-	-	-	(2)	-
As at 31/03/2021	-	-	-	-	(1)	-
<b>Increase in Price to Book Multiple by 10%</b>						
<b>As at 31/03/2022</b>	-	7	-	1	-	-
As at 31/03/2021	-	7	-	1	-	-

Sensitivity with decrease in yield and Price Book Multiplier by 0.5% and 10% will have equal and opposite impact in financial statement.

**(v) Valuation Process**

Some of the Company's assets and liabilities are measured at fair value for financial reporting purposes. The Management of the Company has set up a team in the finance department which performs the valuation of financial assets and liabilities.

In estimating the fair value of an asset or a liability, the Company uses market-observable data to the extent it is available. Where Level 1 inputs are not available, the Company engages third party qualified valuers to perform the valuation. The team works closely with the qualified external valuers to establish the appropriate valuation techniques and inputs to the model. The team reports findings to the Management of the Company to explain the cause of fluctuations in the fair value of the assets and liabilities.

**(vi) Valuation techniques used for valuation of instruments categorised as level 3**

For valuation of investments in equity shares and associates which are unquoted, peer comparison has been performed wherever available. Valuation has been primarily done by considering the net worth of the Company and price to book multiple to arrive at the fair value. In cases where income approach was feasible valuation has been arrived using the earnings capitalisation method. For inputs that are not observable for these instruments, certain assumptions are made based on available information. The most significant of these assumptions are the discount rate and credit spreads used in the valuation process.

For valuation of investments in debt securities categorised as level 3, market polls which represent indicative yields are used as assumptions by market participants when pricing the asset.

There were no significant inter-relationships between unobservable inputs that materially affect fair values.

## 48. Financial Risk Management

Refer Note 1B (P) for accounting policy on Financial Instruments

The Company's activities exposes it to various risks such as market risk, liquidity risk and credit risk. This section explains the risks, which the Company is exposed to and how it manages those risks.

### A Market Risk

**(i) Market Risk : Commodity Price Risk**

Hindalco's India Operations consist of two businesses – Copper Business and Aluminium Business. The Copper Business works under a "Custom Smelting" model wherein the focus is to improve the processing margin. The timing mis-match risk between the input and output price, which is linked to the same international pricing benchmark, is eliminated through use of derivatives. This off-set hedge model (through use of derivatives) is used to manage the timing mis-match risk for both Commodity (Copper and Precious Metals) and Currency Risk (primarily, USD/INR). The Copper Business also has a portion of View Based exposure for both Commodity and Currency, beyond the above timing mis-match risk. Lower Copper Prices, Stronger USD/INR exchange rate and Higher "Other Input" Prices (eg Coal, furnace oil, natural gas etc) are the major price risks that adversely impact the business. Here, the Company may use derivative instruments, wherever available, to manage these pricing risks. A variety of factors, including the risk appetite of the business and price view, are considered while taking Hedging Decisions. Such View based hedges are usually done for the next 1-12 quarters.

The Aluminium Business is a vertically integrated business model wherein the input and output pricing risks are independent of each other, i.e. – are on different pricing benchmarks, if any. Here, the Company may use derivative instruments, wherever available, to manage its pricing risks for both input and output products. Lower Aluminium Prices, Stronger USD/INR exchange rate and Higher Input Prices (e.g. Alumina, furnace oil, coal, coal tar pitch) are the major price risks that adversely impact the Business. Hedging decisions are based on a variety of factors, including risk appetite of the business and price View. Such Hedge decisions are usually done for the next 1-12 quarters.

#### Embedded Derivatives

Copper concentrate is purchased on future pricing model based on month's average LME (in case of copper) / LBMA (in case of gold and silver). Since, the value of the concentrate changes with response to change in commodity pricing indices, embedded derivatives (ED) is identified and segregated in the contract. The ED so segregated, is treated like commodity derivative and qualify for hedge accounting. These derivatives are put into a Fair Value hedge relationship with respect to inventory.

# Notes

forming part of the Standalone Financial Statements

(a) The table below summarises gain/(loss) impact of increase/decrease in the commodity price on the company's equity and profit for the year:

(₹ in Crore)

Commodity Risk	Price Index	Increase in Price	Year ended			
			31/03/2022		31/03/2021	
			Gain/ (Loss) in Statement of Profit and Loss Post Tax	Gain/ (Loss) in Other Components of Equity Post Tax	Gain/ (Loss) in Statement of Profit and Loss Post Tax	Gain/ (Loss) in Other Components of Equity Post Tax
Aluminium	LME	10%	-	(767)	-	(613)
Copper	LME	10%	(850)	-	(696)	(24)
Gold	LBMA/ MCX	10%	(136)	-	(104)	-
Silver	LBMA	10%	(10)	-	(19)	-
Furnace Oil	AG Platts	10%	-	-	-	6

Decrease in prices by 10% will have equal and opposite impact in financial statements. Sensitivity analysis has been computed by stress testing the market price of the underlying price index on the outstanding derivative position as on the reporting date by assuming all other factors constant.

(ii) Market Risk : Foreign Currency Risk

Exchange rate movements, particularly the United States Dollar (USD) and Euro (EUR) against Indian Rupee (INR), have an impact on our operating results. In addition to the foreign exchange inflow from exports, the commodity prices in the domestic market are derived based on the landed cost of imports in India where LME prices and USD/INR exchange rate are the main factors. In case of conversion business, the objective is to match the exchange rate of outflows and related inflows through derivative financial instruments. With respect to Aluminium business where costs are predominantly in INR, the strengthening of INR against USD adversely affects the profitability of the business and benefits when INR depreciates against USD. The company enters into various foreign exchange contracts to protect profitability. The Company also enters into various foreign exchange contracts to mitigate the risk arising out of foreign currency exchange rate movement in foreign currency contracts executed with foreign suppliers to procure capital items for its project activities.

During the year ended, the Company's foreign c exposure arising from exports and import transactions resulted in the FOB value of exports amounting to ₹ 21,416 crore (31/03/2021 ₹ 13,860 crore) and the CIF value of imports amounting to ₹ 36,807 crore (31/03/2021 ₹ 21,274 crore).

(a) The Company's net exposure to foreign currency risk at the end of the reporting period expressed in ₹ is given below:

(₹ in Crore)

Currency Pair	As at	
	31/03/2022	31/03/2021
	NOK	1
CHF	1	1
	2	2

Assets and liabilities that are naturally hedged against future transactions are excluded for the purpose of above disclosure. As on March 31, 2022 the Company has USD, EUR and GBP foreign currency payables of ₹ 10,126 crore (March 31, 2021 ₹ 9,870 crore) which will be offsetted by an equal amount of foreign currency receivables in the next financial year.

(b) The table below summarises gain/(loss) impact of increase/decrease in the exchange rates on the Company's equity and profit for the year:

(₹ in Crore)

Currency Risk	Increase in Rate/Price	Year ended			
		31/03/2022		31/03/2021	
		Gain/ (Loss) in Statement of Profit and Loss Post Tax	Gain/ (Loss) in Other Components of Equity Post Tax	Gain/ (Loss) in Statement of Profit and Loss Post Tax	Gain/ (Loss) in Other Components of Equity Post Tax
USD/INR	10%	(13)	(1,158)	33	(1,110)
EUR/INR	10%	-	-	3	1
EUR/USD	10%	8	-	-	-

Decrease in prices by 10% will have equal and opposite impact in financial statements. Sensitivity analysis has been computed by stress testing the market price of the underlying currency index on the outstanding derivative position and unhedged exposure as on the reporting date by assuming all other factors constant.

(iii) Market Risk: Equity Securities Price Risk

The Company's exposure to equity securities price risk arises from movement in market price of related securities classified either as FVTOCI or FVTPL. The Company manages the price risk through diversified portfolio.

The table below summarises gain/(loss) impact on of increase/decrease in the equity share price on the Company's equity and profit for the year:

(₹ in Crore)

Other Price Risk	Price Index	Increase Rate/Price	Year ended			
			31/03/2022		31/03/2021	
			Gain/ (Loss) in Statement of Profit and Loss Post Tax	Gain/ (Loss) in Other Components of Equity Post Tax	Gain/ (Loss) in Statement of Profit and Loss Post Tax	Gain/ (Loss) in Other Components of Equity Post Tax
Investment in Equity Securities	NSE	10%	-	724	-	636

Decrease in prices by 10% will have equal and opposite impact in financial statements. Sensitivity analysis has been computed by stress testing the market price of the underlying price index on the investment portfolio as on the reporting date by assuming all other factors constant.

(iv) Market Risk: Interest Rate Risk

The Company is exposed to interest rate risk on financial liabilities such as borrowings, both short-term and long-term. It maintains a balance of fixed and floating interest rate borrowings and the proportion is determined by current market interest rates, projected debt servicing capability and view on future interest rates. Such interest rate risk is actively evaluated and interest rate swap is taken whenever considered necessary.

The Company is also exposed to interest rate risk on its financial assets that include fixed deposits, bonds, debentures, commercial papers, other mutual funds and liquid investments comprising mainly mutual funds (which are part of cash and cash equivalents). Since, majority of these are generally for short durations, the Company believes it has limited interest rate risk.

# Notes

forming part of the Standalone Financial Statements

(a) The table below summarises gain/(loss) impact of increase/decrease in the interest rates on the Company's equity and profit for the year:

Interest Rate Risk	Increase in Rate	Year ended			
		31/03/2022		31/03/2021	
		Gain/ (Loss) in Statement of Profit and Loss Post Tax	Gain/ (Loss) in Other Components of Equity Post Tax	Gain/ (Loss) in Statement of Profit and Loss Post Tax	Gain/ (Loss) in Other Components of Equity Post Tax
Interest rate on floating rate borrowings	100 bps	(60)	-	(61)	-

(₹ in Crore)

Decrease in rates by 100 bps will have equal and opposite impact in financial statements. Sensitivity analysis has been computed by stress testing the interest rates applicable (i.e. USD 6M SOFR, SBI 3M MCLR, PNB 1M MCLR, Repo Rate and 3M T-bill etc.) on the amount of borrowings during the year by assuming all other factors constant.

## Derivatives

The Company does not have any interest rate hedges outstanding as on the reporting date, accordingly IBOR related impact on hedge accounting including discounting of other derivatives is not expected to be material.

## B Liquidity Risk

The Company determines its liquidity requirements in the short, medium and long term. This is done by drawing up cash forecast for short and medium term requirements and strategic financing plans for long term needs.

The Company manages its liquidity risk in a manner so as to meet its normal financial obligations without any significant delay or stress. Such risk is managed through ensuring operational cash flow while at the same time maintaining adequate cash and cash equivalents position. The management has arranged for diversified funding sources and adopted a policy of managing assets with liquidity in mind and monitoring future cash flows and liquidity on a regular basis. Surplus funds not immediately required are invested in certain financial assets (including mutual funds) which provide flexibility to liquidate at short notice and are included in current investments and cash equivalents. Besides, it generally has certain undrawn credit facilities which can be accessed as and when required, which are reviewed periodically.

The Company has developed appropriate internal control systems and contingency plans for managing liquidity risk. This incorporates an assessment of expected cash flows and availability of alternative sources for additional funding, if required.

### (i) Financing Arrangement

The Company had access to the following undrawn borrowing facilities at the end of the reporting period:

	As at	
	31/03/2022	31/03/2021
Bank Overdraft and other facilities	1,642	1,652

(₹ in Crore)

Undrawn limit has been calculated based on the available drawing power and sanctioned amount at each reporting date.

### (ii) Maturity Analysis

The company's financial liabilities into relevant maturity groupings based on their contractual maturities for all non-derivative financial liabilities and net settled derivative financial instruments. The amounts disclosed in the table are the contractual undiscounted cash flows. Balances due within 12 months equal their carrying balances as the impact of discounting is not significant.

Contractual maturities of financial liabilities as at 31/03/2022	Note No.	Less than 1 Year	Between 1 and 2 Years	Between 2 and 5 Years	Over 5 years	Total	Carrying Value
<b>Non Derivatives</b>							
Borrowings (a)							
Principal Payments	18A, 18B & 21B	7,412	83	3,991	7,651	19,137	19,079
Interest Payments		897	757	2,048	1,126	4,828	-
Lease liabilities (b)	2	82	54	130	542	808	342
Supplier's Credit	19	2,459	-	-	-	2,459	2,456
Trade payables	20	11,015	-	-	-	11,015	11,015
Other financial liabilities	21A & 21B	1,000	13	-	-	1,013	1,013
		<b>22,865</b>	<b>907</b>	<b>6,169</b>	<b>9,319</b>	<b>39,260</b>	<b>33,905</b>
<b>Derivatives (net settled)</b>							
Commodity forwards/swaps/options	49	3,368	387	10	-	3,765	3,732
Currency forwards/options		31	-	-	-	31	31
		<b>3,399</b>	<b>387</b>	<b>10</b>	<b>-</b>	<b>3,796</b>	<b>3,763</b>

(₹ in Crore)

Contractual maturities of financial liabilities as at 31/03/2021	Note No.	Less than 1 Year	Between 1 and 2 Years	Between 2 and 5 Years	Over 5 years	Total	Carrying Value
<b>Non Derivatives</b>							
Borrowings (a)							
Principal Payments	18A, 18B & 21B	4,757	6,008	2,023	7,202	19,990	19,929
Interest Payments		731	1,198	1,752	1,086	4,767	-
Lease liabilities (b)	2	91	48	95	560	794	311
Supplier's Credit	9A	255	-	-	-	255	255
Trade payables	20	8,800	-	-	-	8,800	8,800
Other financial liabilities	21A & 21B	937	10	-	-	947	947
		<b>15,571</b>	<b>7,264</b>	<b>3,870</b>	<b>8,848</b>	<b>35,553</b>	<b>30,242</b>
<b>Derivatives (net settled)</b>							
Commodity forwards/swaps/options	49	1,543	365	26	-	1,934	1,932
Currency forwards/options		14	-	-	-	14	13
		<b>1,557</b>	<b>365</b>	<b>26</b>	<b>-</b>	<b>1,948</b>	<b>1,945</b>

(₹ in Crore)

- (a) Includes Principal and interest payments, short term borrowings, current portion of debt and excludes unamortised fees.
- (b) Total cash outflow for leases for the year ended 31/03/2022 is ₹ 225 crore (31/03/2021: ₹ 181 crore), includes ROU Lease payment, Short term lease and Low value lease, refer note 18A(d) and 37.



# Notes

forming part of the Standalone Financial Statements

## (C) Credit Risk

Credit risk is the risk of financial loss to the Company if a customer or counterparty to a financial instrument fails to meet its contractual obligation.

Credit risk arises from cash and cash equivalents, contractual cash flows of debt investments, favourable derivative financial instruments and deposits with banks and financial institutions, as well as credit exposures to customers including outstanding receivables.

Credit risk is managed on an entity level basis. The Company has adopted a policy of dealing only with creditworthy counterparties and obtaining sufficient collateral, where appropriate, as a means of mitigating risk of financial loss from defaults. The Company invests only in those instruments issued by high rated banks/ institutions and government agencies. The Company assesses the credit quality of the customer, taking into account its financial position, past experience and other factors. The Company's investments in debt instruments and certain loans are considered to have low credit risk. The credit ratings of the investments are monitored for credit deterioration.

For some trade receivables the Company obtains security in the form of guarantees, deed of undertaking or letters of credit which can be called upon if the counterparty is in default under the terms of the agreement.

The Company periodically monitors the recoverability and credit risks of its other financial assets including security deposits and other receivables. The Company evaluates 12 month expected credit losses for all the financial assets for which credit risk has not increased. In case credit risk has increased significantly, the Company considers life time expected credit losses for the purpose of impairment provisioning.

The Company has used a practical expedient by computing the expected credit loss allowance for trade receivables based on a provision matrix. The provision matrix takes into account historical credit loss experience and adjusted for forward-looking information. The expected credit loss allowance is based on the ageing of the days for which the receivables are due and the expected loss rates as given in the provision matrix. The provision matrix at the end of the reporting period is as follows:

### (i) Summary of trade receivables and provision with ageing as at 31-Mar-22

(₹ in Crore)

Particulars	Past due						Total
	Not due	1 to 30 days	31 to 60 days	61 to 120 days	121 to 180 days	Over 180 days	
Gross carrying amount - Domestic	1,938	133	37	18	6	49	2,181
Gross carrying amount - Export	501	23	1	1	-	1	527
Expected loss rate	0.00%	0.00%	0.00%	0.00%	0.00%	6.00%	0.11%
Expected credit loss provision	-	-	-	-	-	3	3
Loss allowance - Credit impaired - Export	-	-	-	-	-	1	1
Loss allowance - Credit impaired - Domestic	-	-	-	-	-	33	33
Total Provision	-	-	-	-	-	37	37
<b>Carrying amount of trade receivables (net of impairment)</b>	<b>2,439</b>	<b>156</b>	<b>38</b>	<b>19</b>	<b>6</b>	<b>13</b>	<b>2,671</b>

### (ii) Summary of trade receivables and provision with ageing as at 31-Mar-21

(₹ in Crore)

Particulars	Past due						Total
	Not due	1 to 30 days	31 to 60 days	61 to 120 days	121 to 180 days	Over 180 days	
Gross carrying amount - Domestic	974	176	43	21	40	41	1,295
Gross carrying amount - Export	294	37	7	-	-	1	339
Expected loss rate	0.00%	0.00%	0.00%	0.00%	0.00%	4.72%	0.12%
Expected credit loss provision	-	-	-	-	-	2	2
Loss allowance - Credit impaired - Export	-	-	-	-	-	1	1
Loss allowance - Credit impaired - Domestic	-	-	-	-	-	29	29
Total Provision	-	-	-	-	-	32	32
<b>Carrying amount of trade receivables (net of impairment)</b>	<b>1,268</b>	<b>213</b>	<b>50</b>	<b>21</b>	<b>40</b>	<b>10</b>	<b>1,602</b>

### (iii) Reconciliation of Provision

(₹ in Crore)

Loss allowance as at 31/03/2020	39
changes in loss allowance	(7)
Loss allowance as at 31/03/2021	32
changes in loss allowance	5
Loss allowance as at 31/03/2022	37

Of the trade receivables balance as at 31/03/2022, ₹ 368 crore (as at 31/03/2021, ₹ 214 crore) is due from a single customer being the Company's largest customer. There are no other customers who represent more than 10% of the total balance of trade receivables.

Financial assets at FVTPL and at FVTOCI: The Company is also exposed to credit risks in relation to financial assets that are measured at FVTPL or at FVTOCI. The maximum exposure at the end of the reporting period is the carrying amount of these assets.

## 49. Derivative Financial Instruments:

Refer Note 1B (P) for accounting policy on Financial Instruments

Refer Note 1B (Q) for accounting policy on Derivatives and hedge accounting

The Company uses derivative financial instruments such as forwards, futures, swaps, options etc. to hedge its risks associated with foreign exchange fluctuation and price risk movements. Risks associated with fluctuation in the price of the products (copper, aluminium, coal, furnace oil, natural gas, coal tar pitch and precious metals) are minimized by undertaking appropriate derivative instruments. Derivatives embedded in other contracts are treated as separate derivatives when their risks and characteristics are not closely related to their host contracts. In some cases, the embedded derivatives may be designated in a hedge relationship. The fair values of all such derivative financial instruments are recognized as assets or liabilities at the balance sheet date.

The Company also applies hedge accounting using certain foreign currency non-derivative monetary items which are used as hedging instruments for hedging foreign exchange risk.

# Notes

forming part of the Standalone Financial Statements

(A) The Asset and Liability position of various outstanding derivative financial instruments is given below:

(₹ in Crore)

	Nature of Risk being Hedged	As at					
		31/03/2022			31/03/2021		
		Liability	Asset	Net Fair Value	Liability	Asset	Net Fair Value
<b>Current</b>							
<b>Cash flow hedges</b>							
Commodity contracts	Price Risk Component	(2,769)	13	(2,756)	(948)	36	(912)
Foreign currency contracts	Exchange rate movement risk	(7)	215	208	-	135	135
<b>Fair Value Hedge</b>							
Commodity contracts	Price Risk Component	(175)	59	(116)	(99)	285	186
Foreign currency contracts	Exchange rate movement risk	(12)	1	(11)	(10)	-	(10)
Embedded Derivatives (i)	Risk of change in Fair Value of unpriced inventory	(489)	5	(484)	(411)	120	(291)
<b>Non-designated hedges</b>							
Commodity contracts	Price Risk Component	(401)	211	(190)	(495)	37	(458)
Foreign currency contracts	Exchange rate movement risk	(12)	8	(4)	(3)	2	(1)
<b>Total</b>		<b>(3,865)</b>	<b>512</b>	<b>(3,353)</b>	<b>(1,966)</b>	<b>615</b>	<b>(1,351)</b>
<b>Non - current</b>							
<b>Cash flow hedges</b>							
Commodity contracts	Price Risk Component	(387)	2	(385)	(390)	2	(388)
Foreign currency contracts	Exchange rate movement risk	-	172	172	-	223	223
<b>Non-designated hedges</b>							
Foreign currency contracts	Exchange rate movement risk	-	-	-	-	-	-
<b>Total</b>		<b>(387)</b>	<b>174</b>	<b>(213)</b>	<b>(390)</b>	<b>225</b>	<b>(165)</b>
<b>Grand Total</b>		<b>(4,252)</b>	<b>686</b>	<b>(3,566)</b>	<b>(2,356)</b>	<b>840</b>	<b>(1,516)</b>

(i) Fair Value net loss of ₹ 484 crore (31/03/2021 net Loss ₹ 291 crore) is classified as part of Trade Payables.

The maturity profile for Commodity forwards, Swaps and Options ranges from April 2022 to March 2024, Foreign Exchange Forwards ranges from April 2022 to March 2025. Hedge Ratio of 1:1 is used by the Company.

The maturity profile of hedges taken based on the nature of risk hedged is tabulated below :

Risk Category	Commodity/ Currency Pair	% of Outstanding Hedges		
		FY 2023	FY 2024	FY 2025
Price Risk	Aluminium	87%	13%	-
	Copper	100%	-	-
	Gold	100%	-	-
	Silver	100%	-	-
Exchange Risk	USD_INR	82%	8%	10%
	EUR_INR	100%	0%	0%
	GBP_INR	0%	0%	0%
	SGD_INR	0%	0%	0%
	EUR_USD	96%	4%	0%

(B) Outstanding position and fair value of various foreign exchange derivative financial instruments:

(₹ in Crore)

	Currency Pair	As at					
		31/03/2022			31/03/2021		
		Weighted Average Strike Rate	Notional Value (in Million)	Fair Value Gain/ (Loss)	Weighted Average Strike Rate	Notional Value (in Million)	Fair Value Gain/ (Loss)
<b>Foreign currency forwards</b>							
<b>Cash flow hedges</b>							
Sell	USD_INR	81.22	1,196	380	81.45	1,069	358
<b>Total</b>				<b>380</b>			<b>358</b>
<b>Fair Value hedges</b>							
Buy	USD_INR	76.85	189	(11)	74.45	159	(10)
<b>Total</b>				<b>(11)</b>			<b>(10)</b>
<b>Non-Designated</b>							
Buy	EUR_INR	98.96	0	(0)	88.57	6	(1)
Buy	USD_INR	77.04	0	(0)	72.98	28	1
Sell	USD_INR	76.35	182	7	73.07	51	(1)
Buy	SGD_INR	-	-	-	55.85	1	-
Buy	EUR_USD	1.19	16	(11)	-	-	-
<b>Total</b>				<b>(4)</b>			<b>(1)</b>
<b>Grand Total</b>				<b>365</b>			<b>347</b>

# Notes

forming part of the Standalone Financial Statements

(C) Outstanding position and fair value of various foreign exchange non-derivative financial instruments used as hedging instruments:

(₹ in Crore)

	Note No.	Currency Pair	As at					
			31/03/2022			31/03/2021		
			Average exchange rate	Notional Value (in Million)	Fair Value Gain/ (Loss)	Average exchange rate	Notional Value (in Million)	Fair Value Gain/ (Loss)
<b>Foreign currency monetary items</b>								
<b>Cash flow hedges</b>								
Debt	18B	USD_INR	74.55	185	(25)	73.13	580	11
<b>Liability for Copper Concentrate</b>								
Host Liability		USD_INR	75.51	695	(19)	72.84	680	(19)
Supplier credit	19	USD_INR	74.77	324	(39)	-	-	-
<b>Total</b>					<b>(83)</b>			<b>(8)</b>

(D) Outstanding position and fair value of various commodity derivative financial instruments

(i) Outstanding position and fair value of various commodity derivative financial instruments as at 31st Mar, 2022:

(₹ in Crore)

	Currency	Weighted Average Strike Rate	Quantity	Unit	Notional value (in millions)	Fair Value Gain/ (Loss)
<b>Commodity Futures/Forwards/Swaps</b>						
<b>Cash Flow Hedge</b>						
Aluminium	Sell	USD	2,535.15	456,000	MT	1,156 (3,141)
Copper	Sell	USD	-	-	MT	-
Furnace Oil	Buy	USD	-	-	MT	-
<b>Total</b>						<b>(3,141)</b>
<b>Fair Value Hedge</b>						
Copper	Sell	USD	10,551.83	37,600	MT	397 50
Gold	Sell	INR	4,972,320	7,543	KGS	37,506 (159)
Silver	Sell	USD	23	485,904	TOZ	11 (7)
<b>Total</b>						<b>(116)</b>
<b>Non Designated hedges</b>						
Aluminium	Buy	USD	3,545.65	32,150	MT	114 (14)
Aluminium	Sell	USD	1,902.34	32,100	MT	61 (386)
Copper	Buy	USD	10,156.12	27,400	MT	278 45
Copper	Sell	USD	10,762.54	35,500	MT	382 105
Gold	Buy	INR	5,041,209	4,352	KGS	21,939 51
Silver	Buy	USD	24.65	244,244	TOZ	6 -
Silver	Sell	USD	24.37	244,244	TOZ	6 (1)
Furnace Oil	Buy	USD	241.34	3,335	MT	1 10
Furnace Oil	Sell	USD	634.23	3,335	MT	2 -
<b>Total</b>						<b>(190)</b>

(₹ in Crore)

	Currency	Weighted Average Strike Rate	Quantity	Unit	Notional value (in millions)	Fair Value Gain/ (Loss)
<b>Embedded derivatives</b>						
<b>Fair Value Hedge</b>						
Copper	Sell	USD	9,838.28	120,552	MT	1,186 (487)
Gold	Sell	USD	1,949.23	29,697	TOZ	58 2
Silver	Sell	USD	24.91	371,143	TOZ	9 0
<b>Total</b>						<b>(484)</b>
<b>Grand Total</b>						<b>(3,931)</b>

(ii) Outstanding position and fair value of various commodity derivative financial instruments as at 31st March, 2021:

(₹ in Crore)

	Currency	Weighted Average Strike Rate	Quantity	Unit	Notional value (in millions)	Fair Value Gain/ (Loss)
<b>Commodity Futures/Forwards/Swaps</b>						
<b>Cash Flow Hedge</b>						
Aluminium	Sell	USD	1,902.25	547,250	MT	1,041 (1,307)
Copper	Sell	USD	8,331.38	5,875	MT	49 (19)
Furnace Oil	Buy	USD	222.52	40,000	MT	9 33
<b>Total</b>						<b>(1,293)</b>
<b>Fair Value Hedge</b>						
Copper	Sell	USD	8,564.24	46,325	MT	397 (76)
Gold	Sell	INR	4,841,222	7,109	KGS	34,416 260
Silver	Sell	USD	24.72		TOZ	26 2
<b>Total</b>						<b>186</b>
<b>Non Designated hedges</b>						
Aluminium	Buy	USD	2,174.75	82,825	MT	180 12
Aluminium	Sell	USD	1,724.41	82,495	MT	142 (283)
Copper	Buy	USD	8,901.87	32,575	MT	290 (26)
Copper	Sell	USD	8,543.45	38,725	MT	331 (71)
Gold	Buy	INR	4,633,701	4,608	KGS	21,352 (78)
Silver	Buy	USD	26.02	1,037,171	TOZ	27 (12)
Silver	Sell	USD	23.88		TOZ	28 (5)
Furnace Oil	Buy	USD	271.47	7,446	MT	2 5
Furnace Oil	Sell	USD	373.43	7,446	MT	3 -
<b>Total</b>						<b>(458)</b>
<b>Commodity Options</b>						
<b>Cash Flow Hedge</b>						
Aluminium	Sell	USD	2,200.42	45,000	MT	99 (7)
<b>Total</b>						<b>(7)</b>
<b>Embedded derivatives</b>						
<b>Fair Value Hedge</b>						
Copper	Sell	USD	8,433.72	113,831	MT	960 (302)
Gold	Sell	USD	1,724.11	38,284	TOZ	66 5
Silver	Sell	USD	26.17	498,103	TOZ	13 6
<b>Total</b>						<b>(291)</b>
<b>Grand Total</b>						<b>(1,863)</b>



# Notes

forming part of the Standalone Financial Statements

(E) The following table presents details of amount held in Effective portion of Cash Flow Hedge and Cost of Hedging Reserve and the period during which these are going to be released and affecting Statement of Profit and Loss.

(₹ in Crore)

Cash Flow Hedges	As at					
	31/03/2022			31/03/2021		
	Closing Value Cash Flow Hedges	Release		Closing Value Cash Flow Hedges	Release	
		Within 12 Months	After 12 Months		Within 12 Months	After 12 Months
Gain/(Loss)	Gain/(Loss)	Gain/(Loss)	Gain/(Loss)	Gain/(Loss)	Gain/(Loss)	
<b>Commodity Forwards/Futures/Swaps</b>						
Aluminium	(3,132)	(2,987)	(145)	(1,306)	(1,001)	(305)
Copper	-	-	-	(19)	(19)	-
Furnace Oil	-	-	-	33	33	-
	<b>(3,132)</b>	<b>(2,987)</b>	<b>(145)</b>	<b>(1,292)</b>	<b>(987)</b>	<b>(305)</b>
<b>Non-Derivative Financial Instruments</b>						
Debt	(25)	(25)	-	11	11	-
Liability for Copper Concentrate						
Host Liability	(29)	(29)	-	5	5	-
Supplier credit	(39)	(39)	-			
<b>Foreign currency Forwards</b>						
USD_INR	379	207	172	358	135	223
	<b>286</b>	<b>114</b>	<b>172</b>	<b>374</b>	<b>151</b>	<b>223</b>
	<b>(2,846)</b>	<b>(2,873)</b>	<b>27</b>	<b>(918)</b>	<b>(836)</b>	<b>(82)</b>
Deferred Tax on above	995	1,004	(9)	322	293	29
<b>Total</b>	<b>(1,851)</b>	<b>(1,869)</b>	<b>18</b>	<b>(596)</b>	<b>(543)</b>	<b>(53)</b>

(₹ in Crore)

Cost of Hedging Reserve	As at					
	31/03/2022			31/03/2021		
	Closing Value Cost of Hedge Reserve	Release		Closing Value Cost of Hedge Reserve	Release	
		Within 12 Months	After 12 Months		Within 12 Months	After 12 Months
Gain/(Loss)	Gain/(Loss)	Gain/(Loss)	Gain/(Loss)	Gain/(Loss)	Gain/(Loss)	
<b>Commodity Forwards/Swaps</b>						
Copper	(60)	(60)	-	22	22	-
Silver	-	-	-	-	-	-
<b>Commodity Options</b>						
Aluminium	-	-	-	(7)	(7)	-
	<b>(60)</b>	<b>(60)</b>	<b>-</b>	<b>15</b>	<b>15</b>	<b>-</b>
Deferred Tax on above	21	21	-	(5)	(5)	-
<b>Total</b>	<b>(39)</b>	<b>(39)</b>	<b>-</b>	<b>10</b>	<b>10</b>	<b>-</b>

(F) Gain/(loss) recognized in OCI and recycled:

i The following tables presents the amount of gain/(loss) recognized in Effective portion of Cash Flow Hedge and Cost of Hedging Reserve and recycled during the financial year 2021-22:

(₹ in Crore)

	Opening Balance	Net Amount recognised	Recycled			Closing Balance
			Net Amount to P&L	Net Amount added to Non-Financial Assets	Total Amount recycled	
<b>Cash Flow Hedges</b>						
Commodity	(1,292)	(4,287)	(2,508)	62	(2,446)	(3,133)
Forex	373	(67)	20	-	20	286
<b>Total</b>	<b>(919)</b>	<b>(4,354)</b>	<b>(2,488)</b>	<b>62</b>	<b>(2,426)</b>	<b>(2,847)</b>
Deferred Tax on above	323	1,521	869	(21)	848	996
<b>Total</b>	<b>(596)</b>	<b>(2,833)</b>	<b>(1,619)</b>	<b>41</b>	<b>(1,578)</b>	<b>(1,851)</b>

	Opening Balance	Net Amount recognised	Recycled			Closing Balance
			Net Amount to P&L	Net Amount added to Non-Financial Assets	Total Amount recycled	
<b>Cost of Hedging Reserve</b>						
Commodity	15	(360)	(285)	-	(285)	(60)
Forex	-	-	-	-	-	-
<b>Total</b>	<b>15</b>	<b>(360)</b>	<b>(285)</b>	<b>-</b>	<b>(285)</b>	<b>(60)</b>
Deferred Tax on above	(5)	126	100	-	100	21
<b>Total</b>	<b>10</b>	<b>(234)</b>	<b>(185)</b>	<b>-</b>	<b>(185)</b>	<b>(39)</b>

ii The following tables presents the amount of gain/(loss) recognized in Effective portion of Cash Flow Hedge and Cost of Hedging Reserve and recycled during the financial year 2020-21:

(₹ in Crore)

	Opening Balance	Net Amount recognised	Recycled			Closing Balance
			Net Amount to P&L	Net Amount added to Non-Financial Assets	Total Amount recycled	
<b>Cash Flow Hedges</b>						
Commodity	604	(2,574)	(681)	3	(678)	(1,292)
Forex	(763)	1,020	(115)	(1)	(116)	373
<b>Total</b>	<b>(159)</b>	<b>(1,554)</b>	<b>(796)</b>	<b>2</b>	<b>(794)</b>	<b>(919)</b>
Deferred Tax on above	57	543	278	(1)	277	323
<b>Total</b>	<b>(102)</b>	<b>(1,011)</b>	<b>(518)</b>	<b>1</b>	<b>(517)</b>	<b>(596)</b>

	Opening Balance	Net Amount recognised	Recycled			Closing Balance
			Net Amount to P&L	Net Amount added to Non-Financial Assets	Total Amount recycled	
<b>Cost of Hedging</b>						
Commodity	1	48	34	-	34	15
Forex	182	7	189	-	189	-
<b>Total</b>	<b>183</b>	<b>55</b>	<b>223</b>	<b>-</b>	<b>223</b>	<b>15</b>
Deferred Tax on above	(64)	(19)	(78)	-	(78)	(5)
<b>Total</b>	<b>119</b>	<b>36</b>	<b>145</b>	<b>-</b>	<b>145</b>	<b>10</b>

# Notes

forming part of the Standalone Financial Statements

(G) The following table presents the amount of gain/ (loss) recycled from Effective portion of Cash Flow Hedge and Cost of Hedging Reserve and reference of the line item in the Statement of Profit and Loss where those amounts are included:

Note No.	Note Description	Particulars	Year Ended	
			Year Ended	
			31/03/2022	31/03/2021
26	Revenue From Operations	Aluminium Products	(2,411)	(471)
26	Revenue From Operations	Copper and Copper Products	(203)	(136)
26	Revenue From Operations	Precious Metals	-	-
37	Other Expenses	Gain/(Loss) on Derivatives	(159)	34
			<b>(2,773)</b>	<b>(573)</b>

(H) The adjustment as a part of the carrying value of inventories arising on account of fair value hedges is as follows:

Increase/ (Decrease) in Inventory Value	As at					
	31/03/2022			31/03/2021		
	Raw Material	WIP and Finished Goods	Total	Raw Material	WIP and Finished Goods	Total
Copper	487	(48)	439	302	93	395
Gold	(2)	69	67	(5)	(54)	(59)
Silver	-	6	6	(6)	(5)	(11)
	<b>485</b>	<b>27</b>	<b>512</b>	<b>291</b>	<b>34</b>	<b>325</b>

(I) The Company's hedging policy only allows for effective hedge relationships to be established. The effective portion of hedge is recognised in OCI, while ineffective portion of hedge is recognised immediately in the Statement of Profit and Loss. For Cash flow hedges, the Company uses hypothetical derivative method to assess effectiveness based on "lower off" assessment.

Sources of Hedge ineffectiveness summarised by risk category are as follows :

Risk Category	Sources of Hedge Ineffectiveness	Type of Hedge
Price Risk	Critical terms Mismatch	Cash Flow and Fair Value Hedge
Basis Risk	Fair Value Hedge	
Credit Risk Adjustment	Cash Flow and Fair Value Hedge	
Exchange Risk	Credit Risk Adjustment	Cash Flow Hedge

The amount of gain/ (loss) recognised in the Statement of Profit and Loss on account of hedge ineffectiveness is as follows:

Note No.	Note Description	Note Description	Type of Hedge	Year Ended	
				Year Ended	
				31/03/2022	31/03/2021
37	Other Expenses	Gain/(Loss) on Derivatives	Cash Flow Hedges	(162)	(111)
37	Other Expenses	Gain/(Loss) on Derivatives	Fair Value Hedges	(130)	(33)
				<b>(292)</b>	<b>(144)</b>

(J) Certain hedges of forecast sale transaction for hedging currency risk were discontinued during the year since the hedged forecast transaction was not expected to occur.

50 Title deeds of the Immovable Properties pending for transfer as at 31 March 2022 are as are as follows:

S. No.	Relevant line item in the Balance sheet	Description of item of property	Gross carrying value	Title deeds held in the name of	Whether title deed holder is a promoter, director or relative of promoter/director or employee of promoter/director	Property held since which date	Reason for not being held in the name of the Company
1	Property, plant and equipment	Freehold Land at Birla Copper	-				
2	Investment Property	Freehold Land at Birla Copper	-	Indogulf Fertilizer & Chemicals Corporation Limited	No	Since FY 2002-03	The title deeds of which are held in the name of Indogulf Fertilizer & Chemicals Corporation Limited (erstwhile Company) which have subsequently been amalgamated with the Company
3	Investment Property	Building at Ahura Centre, Mumbai	7				
4	Property, plant and equipment	Freehold Land at Hirakud unit, Muri unit and Kolkata Branch	-				
5	Property, plant and equipment	Various Buildings at Mumbai, Delhi, Bangalore, Kolkata, Darjeeling,	10	Indian Aluminium Company Limited	No	Since FY 2004-05	The title deeds of which are held in the name of Indian Aluminium Company Limited (erstwhile Company) which have subsequently been amalgamated with the Company
6	Right of use Assets	Land at Hirakud unit and Kolkata Branch	-				
7	Property, plant and equipment	Freehold Land at Kuppam	1	SAPA Extrusion India Private Limited	No	Since FY 2021-22	The title deeds are held in the name of the SAPA Extrusion India Private Limited (erstwhile Company) which have subsequently been acquired by the Company. The Company is in process of registering the title deed of this land in its name.
8	Property, plant and equipment	Freehold Land at Mahan	4	Various Individual Landowners	No	Since FY 2013-14	Certain original land-related documents held in the name of original landowners were submitted to the bank that had financed the Mahan project. These original documents are required to be submitted to the land department in order to get the title deed registered in the name of the Company. The Company is awaiting receipt of these original land-related documents from the bank to initiate the process of transfer of the title of the land in favour of the Company.
9	Property, plant and equipment	Freehold Land at Kathotia Mines	27	Various Individual Landowners	No	Since FY 2018-19	Approval of the District collector is awaited which is a prerequisite as per the Chota Nagpur Tenancy Act, 1908 to transfer the title deed in the name of the company. The company is in the process of obtaining these approvals.

# Notes

forming part of the Standalone Financial Statements

Title deeds of the Immovable Properties pending for transfer as at 31 March 2021 are as follows:

S. No.	Relevant line item in the Balance sheet	Description of item of property	Gross carrying value	Title deeds held in the name of	Whether title deed holder is a promoter, director or relative of promoter/director or employee of promoter/director	Property held since which date	Reason for not being held in the name of the Company
1	Property, plant and equipment	Freehold Land at Birla Copper	-	Indogulf Fertilizer & Chemicals Corporation Limited	No	Since FY 2002-03	The title deeds of which are held in the name of Indogulf Fertilizer & Chemicals Corporation Limited (erstwhile Company) which have subsequently been amalgamated with the Company
2	Investment Property	Freehold Land at Birla Copper	-	Indogulf Fertilizer & Chemicals Corporation Limited	No	Since FY 2002-03	The title deeds of which are held in the name of Indogulf Fertilizer & Chemicals Corporation Limited (erstwhile Company) which have subsequently been amalgamated with the Company
3	Investment Property	Building at Ahura Centre, Mumbai	7				
4	Property, plant and equipment	Freehold Land at Hirakud unit, Muri unit and Kolkata Branch	-				
5	Property, plant and equipment	Various Buildings at Mumbai, Delhi, Bangalore, Kolkata, Darjeeling,	10	Indian Aluminium Company Limited	No	Since FY 2004-05	The title deeds of which are held in the name of Indian Aluminium Company Limited (erstwhile Company) which have subsequently been amalgamated with the Company
6	Right of use Assets	Land at Hirakud unit and Kolkata Branch	-				
7	Property, plant and equipment	Freehold Land at Mahan	4	Various Individual	No	Since FY 2013-14	Certain original land-related documents held in the name of original landowners were submitted to the bank that had financed the Mahan project. These original documents are required to be submitted to the land department in order to get the title deed registered in the name of the Company. The Company is awaiting receipt of these original land-related documents from the bank to initiate the process of transfer of the title of the land in favour of the Company.
8	Property, plant and equipment	Freehold Land at Kathotia Mines	27	Various Individual	No	Since FY 2018-19	Approval of the District collector is awaited which is a prerequisite as per the Chota Nagpur Tenancy Act, 1908 to transfer the title deed in the name of the company. The company is in the process of obtaining these approvals.

## 51 Relationship with struck off companies

Disclosure related to relationship of the Company with a company which is Struck off under Section 248 of the Companies Act, 2013 or Section 530 of Companies Act, 1956 as at 31 March 2022 are as follows:

S. No.	Name of struck off Company	Nature of transactions with struck-off Company	Balance outstanding as at 31 March 2022	Balance outstanding as at 31 March 2021	Relationship with the Struck off company, if any, to be disclosed
1	Daga Nylomet Private Limited	Sale of Goods and Services	1	1	Not a related party
2	Gapscib Trading Private Limited	Sale of Goods and Services	2	2	Not a related party

S. No.	Name of struck off Company	Nature of transactions with struck-off Company	Balance outstanding as at 31 March 2022	Balance outstanding as at 31 March 2021	Relationship with the Struck off company, if any, to be disclosed
<b>Payables</b>					
1	KNOP Trading Company Private Limited	Purchase of Goods and Services	-	-	Not a related party
2	Saturn Mining & Exploration Private Limited	Purchase of Goods and Services	-	-	Not a related party
3	Agngreen Pest Control Services Private Limited	Purchase of Goods and Services	-	-	Not a related party
4	Black Bird E-Solutions Private Limited	Purchase of Goods and Services	-	-	Not a related party
5	Singhal Bricks Private Limited	Purchase of Goods and Services	-	-	Not a related party
6	Sonebhadra Automobiles Private Limited	Purchase of Goods and Services	-	-	Not a related party
<b>Other Outstanding balances</b>					
1	Apple Insulated Wires Private Limited	Contract liability	-	-	Not a related party
2	Payal Synthetics Private Limited	Contract liability	-	-	Not a related party
3	Tecon Surface Coating & Engineering Private Limited	Contract liability	-	-	Not a related party

52. Gare Palma IV/4 (GP-4), Gare Palma IV/5 (GP-5) and Kathautia coal mines were acquired by the Company through auction conducted by the Nominated Authority (NA) constituted under the Ministry of Coal, Government of India. The Company was required to achieve certain efficiency parameters and reach their Peak Rated Capacity (PRC) during FY 2015-16. Performance security in the form of Performance Bank Guarantees (PBG) of ₹ 318 crore (for GP-4), ₹ 369 crore (for GP-5) and ₹ 267 crore (for Kathautia) were provided by the Company to NA in this regard.

Due to the various delays on the part of Government Authorities, PRC was achieved by the Company for GP-4 and GP-5 during FY 2016-17 and for Kathautia during FY 2017-18. Having satisfied itself about achievement of efficiency parameters/ PRC, NA returned the PBG in respect of GP-4 on June 19, 2017. However, in a volte face action, vide a letter dated 25th April, 2018, NA imposed a penalty equal to 20% of PBG amounting to ₹ 64 crore for GP-4, ₹ 74 crore for GP-5 and ₹ 118 crore for Kathautia (refer note 10). As the PBG for GP-5 and Kathautia was still with NA, it also appropriated an amount equal to the penalty from the PBG of the respective mines.

The above actions were contested by the Company. The Hon'ble Chhattisgarh High Court at Bilaspur has already given its judgment in favour of the Company in the matter related to GP-5. As per the judgment, Hon'ble High Court has asked NA to refund the amount appropriated by them and return the PBG to the Company. The NA has filed an appeal before the Hon'ble Supreme Court which has not been taken up for hearing yet. The Company's appeal to quash the demand raised by NA in case of GP-4 and Kathautia is yet to be decided and is pending before the Mines Tribunal at Bilaspur and Ranchi respectively.



# Notes

forming part of the Standalone Financial Statements

## 53. Acquisition of Kuppam unit of SAPA Extrusions India Private Limited (considered as Business Combination)

Refer Note 1A (AA) for accounting policy on Business Combination

On February 1, 2022, Hindalco has completed acquisition of Extrusion business of SAPA Extrusion India Private Limited, a manufacturer of high end extrusion products, pursuant to a Business Transfer Agreement (BTA) dated December 17, 2021. The Kuppam facility's specialised product portfolio will enhance the Company's capabilities in high-end extrusions.

Details of purchase consideration, the net assets acquired and goodwill are as follows:

	(₹ in Crore)
Total amount paid	265
<b>Total purchase consideration as per Ind AS 103</b>	<b>265</b>

The Purchase Price Allocations (PPA) were made to the assets acquired and liabilities assumed based on the estimated fair values at the date of acquisition. The excess of the purchase price over the fair value of the net assets acquired was allocated to goodwill.

The assets and liabilities recognised as a result of the acquisition as at March 31, 2022 are as follows:

	(₹ in Crore)
<b>Net Assets acquired</b>	<b>Amount as at 31/03/2022</b>
Property Plant and Equipment (including CWIP)	133
Intangible assets	23
Inventories	60
Trade Receivables	43
Other Assets	39
<b>Total Assets - (A)</b>	<b>298</b>
Trade Payables	29
Provisions	4
Other Liabilities	4
<b>Liabilities - (B)</b>	<b>37</b>
<b>Net identifiable assets acquired (A-B)</b>	<b>261</b>
<b>Calculation of goodwill</b>	
Consideration transferred	265
Less: Net identifiable assets acquired	(261)
<b>Goodwill</b>	<b>4</b>

The above fair values of assets acquired and liabilities assumed are final as of March 31, 2022. The fair values of the assets acquired and liabilities assumed were determined using the income and cost approach. In many cases, the determination of the fair values required estimates about discount rates, future expected cash flows and other future events that are judgmental and subject to change. The fair value measurements are primarily based on significant inputs that are not observable in the market and thus represent a Level 3 measurement of the fair value hierarchy as defined in Ind AS 113, Fair Value Measurements ("Ind AS 113"). Intangible assets consists of Customer Relationships valued using 'With and Without/incremental Cash flow method' and Technical Know How are valued using the 'Relief From Royalty method'. A cost and market approach has been applied, as appropriate, for Property, Plant and Equipment.

## Revenue and profit contribution

Since the acquisition date, Extrusion Business operations included in the Financial Statements for the year ended March 31, 2022 comprises of Revenue of ₹ 66 crore and Net Profit before tax of ₹ 5 crore.

The following supplemental pro forma financial information presents the Company results of operations as of March 31, 2022 as if the acquisition of Extrusion business had occurred on April 1, 2021.

	(₹ in Crore)
	<b>Year ended 31/03/2022</b>
Revenue from Operations	67,988
Profit for the year	5,531

The pro forma financial information reflects pro forma adjustments to present the combined pro forma results of operations as if the acquisition had occurred on April 1, 2021 to give effect to certain events the Company believes to be directly attributable to the acquisition. These pro forma adjustments primarily include:

- the additional depreciation and amortisation that would have been charged assuming the fair value adjustments to property, plant and equipment and intangible assets had applied from 1 April 2021, together with the consequential tax effects.
- acquisition-related transaction costs and other one-time costs directly attributable to the acquisition reflected as if they occurred at the beginning of the annual reporting period.

	(₹ in Crore)
<b>Purchase consideration - cash outflow</b>	<b>Year ended 31/03/2022</b>
Outflow of cash required to acquire Extrusion Business	265

## Acquisition-related costs

Acquisition-related costs of ₹ 6 crore that were not directly attributable to the acquisition are included in Other Expenses in the Statement of Profit and Loss and in operating cash flows in the statement of cash flows.

## 54 Financials Ratio Analysis:

Particulars	Times/ %	Note	As at		
			31/03/2022	31/03/2021	Change in %
(a) Current Ratio	Times		1.75	1.52	15.16%
(b) Debt-Equity Ratio	Times		0.36	0.40	-11.74%
(c) Debt Service Coverage Ratio	Times	(i)	7.83	3.17	147.06%
(d) Return on Equity Ratio	%	(ii)	11%	2%	407.19%
(e) Inventory turnover ratio	Times		3.66	3.14	16.73%
(f) Trade Receivables turnover ratio	Times	(iii)	31.67	23.11	37.01%
(g) Trade payables turnover ratio	Times		5.60	5.15	8.91%
(h) Net capital turnover ratio	Times		4.08	4.45	-8.41%
(i) Net profit ratio	%	(iv)	8%	2%	250.05%
(j) Return on Capital employed	%	(v)	13%	4%	205.65%
(k) Return on investment	%	(vi)	11%	4%	191.55%

# Notes

forming part of the Standalone Financial Statements

## Description of ratios:

- (a) Current Ratio: Current Assets/Current Liabilities excluding Current Maturities of Long term Borrowings
- (b) Debt-Equity Ratio: (Borrowings + Lease Liabilities)/ Total Equity
- (c) Debt Service Coverage Ratio: Profit before Depreciation, Amortisation, Impairment Loss on Non-Current Assets, Finance Cost and Tax)/ (Finance Cost (net of capitalization) + Scheduled Principal Repayment (Excluding Prepayment))
- (d) Return on Equity Ratio: Profit after tax/ Average shareholder equity
- (e) Inventory turnover ratio: Revenue from Operations/Average Inventory
- (f) Trade Receivables turnover ratio: Revenue from Operations /Average Trade Receivable
- (g) Trade payables turnover ratio: Purchases of Raw Material and traded purchases/ Average Trade Payable related to Raw Material and traded purchases
- (h) Net capital turnover ratio: Revenue from Operations/ Working Capital excluding Current Maturities of Long term Borrowings
- (i) Net profit ratio: Profit after tax/ Revenue from Operations
- (j) Return on Capital employed: Earnings before interest and taxes/ Capital Employed (Tangible Net worth + Total Debt + Deferred Tax liability)
- (k) Return on investment: Earnings before interest and tax/ Average total assets

## Clarification for changes

- (i) Ratio improved majorly due to increase in profit on account of higher revenue from operation in the current year.
- (ii) Increase in this ratio is mainly on account of increase in net profit available to equity shareholders in the current year.
- (iii) Increase in this ratio is mainly on account of higher revenue from operations during the year.
- (iv) Net profit ratio has improved mainly on account of increase in profits due to higher margins contributed by increase in volume and higher realization on sales.
- (v) Ratio improved majorly due to majorly due to increase in net profit during the year.
- (vi) Increase in this ratio is mainly on account of increase in earnings before interest and tax majorly due to increase in volume and higher realization on sales.

## 55 The following entities are consolidated in Standalone Financial Statements:

Name of the Entity	Relationship	% of Holding	Country of Incorporation
Mahan Coal Limited	Joint Control Operation *	50%	India
Tubed Coal Mines Limited	Joint Control Operation *	60%	India
Trident Trust	Trust controlled by the Company	#	India
Hindalco Employee Welfare Trust	Trust controlled by the Company	#	India

# Treasury Shares are held in Trusts whose sole beneficiary is Hindalco Industries Limited, refer note 16 for further details.

\* The proportionate share of total assets and total comprehensive income in the above joint operations are consolidated in standalone financial statements.

## 56 Additional Information

- A. As per Section 135 of the Companies Act, 2013, a company, meeting the applicability threshold, needs to spend at least 2% of its average net profit for the immediately preceding three financial years on Corporate social Responsibility (CSR) activities. A CSR committee has been formed by the Company as per the Act. The funds were primarily allocated to a corpus and utilized through the year on these activities which are specified in Schedule VII of the Companies Act, 2013:

- i) Gross amount required to be spent by the company during the year is ₹ 24 crore.
- ii) Amount spent during the year

Particulars	₹ in Crore	
	31/03/2022	31/03/2021
a) Construction/ acquisition of any asset <sup>^</sup>	-	1
b) On purposes other than (a) above	38	39
<b>Total</b>	<b>38</b>	<b>40</b>

<sup>^</sup> Assets are not in the books of the Company

- iii) Details of excess amount spent under Section 135(5) of the Companies Act, 2013

Particulars	₹ in Crore	
	31/03/2022	31/03/2021
<b>Opening Balance excess spent</b>	<b>12</b>	<b>-</b>
Amount required to be spent during the year	24	27
Amount spent during the year	38	40
CSR expenses claimed in Current year	26	28
<b>Closing Balance excess spent</b>	<b>24</b>	<b>12</b>

- iv) The areas for CSR activities are eradication of hunger and malnutrition, promoting education, art and culture, healthcare, destitute care and rehabilitation, environment sustainability, disaster relief, COVID-19 relief and rural development projects.
- v) The contribution to a trust controlled by the company in relation to CSR expenditure is Hindalco Jan Seva Trust amounting to ₹ 1 crore (year ended 31/03/2021 ₹ 6 crore).
- vi) There is no provision made with respect to a liability incurred by entering into a contractual obligation during the current year.

- B. Details of loans given, investment made and guarantee given covered under section 186(4) of the Companies Act, 2013:

- i. Details of investments made have been given as part of Note '5' Investments in Subsidiary, Note '6' Investments in Associates and Joint Ventures and Note '7A and 7B' Other Investments.

- ii. Loans and Financial Guarantees given below:

Name of the Company	Relationship	Nature of Transaction	₹ in Crore	
			31/03/2022	31/03/2021
<b>Details of Loans</b>				
Aditya Birla Science and Technology Company Private Limited	Associate	Loan	36	41
Suvas Holding Limited	Subsidiary	Loan	5	8
Birla Copper Asoj Private Limited (formerly known as Ryker Base Private Limited)	Subsidiary	Loan	164	-
<b>Details of Guarantee</b>				
Dahej Harbour and Infrastructure Limited	Subsidiary	Performance Guarantee	5	5

# Notes

forming part of the Standalone Financial Statements

- iii. Disclosure relating to amount outstanding at year end and maximum outstanding during the year of loans and advances, in nature of loan, required under SEBI (Listing Obligations and Disclosure Requirements) Regulations, 2015, are given below:

(₹ in Crore)

Name of the Company	As at 31/03/2022	Maximum outstanding during FY 2021-22	As at 31/03/2021	Maximum outstanding during FY 2020-21
<b>Associate:</b>				
Aditya Birla Science and Technology Company Private Limited	36	41	41	46
<b>Subsidiaries:</b>				
Suvas Holding Limited	5	8	8	9
Birla Copper Asoj Private Limited (formerly known as Ryker Base Private Limited)	164	200	-	-

**C. Additional disclosures required under Schedule III are as follows:**

- i) No proceedings have been initiated on or are pending against the Company for holding benami property under the Benami Transactions (Prohibition) Act, 1988 (45 of 1988) and Rules made thereunder.
- ii) Hindalco Industries limited have not been declared wilful defaulter by any bank or financial institution or government or any government authority.
- iii) Hindalco Industries Limited has complied with the number of layers prescribed under the Companies Act, 2013.
- iv) There is no undisclosed income under the Income Tax Act, 1961 for the year ending 31st March 2022 and 31st March 2021 which needs to be recorded in the books of account.
- v) Hindalco Industries Limited has not traded or invested in crypto currency or virtual currency during the current or previous year.
- vi) The borrowings obtained by the company from banks and financial institutions have been applied for the purposes for which such loans were was taken.
- vii) There are no charges or satisfaction which are yet to be registered with the Registrar of Companies beyond the statutory period.
- viii) **Utilisation of borrowed funds and share premium.**
  - A) The Company has not advanced or loaned or invested funds to any other person(s) or entity(ies), including foreign entities (Intermediaries) with the understanding that the Intermediary shall: a. directly or indirectly lend or invest in other persons or entities identified in any manner whatsoever by or on behalf of the group (Ultimate Beneficiaries) orb. provide any guarantee, security or the like to or on behalf of the ultimate beneficiaries
  - B) The Company has not received any fund from any person(s) or entity(ies), including foreign entities (Funding Party) with the understanding (whether recorded in writing or otherwise) that the Company shall:a. directly or indirectly lend or invest in other persons or entities identified in any manner whatsoever by or on behalf of the Funding Party (Ultimate Beneficiaries) orb. provide any guarantee, security or the like on behalf of the ultimate beneficiaries
- ix) The Company has not entered into any scheme of arrangement which has an accounting impact on current or previous financial year.
- x) The Company has borrowings from banks on the basis of security of current assets. The quarterly returns or statements of current assets filed by the Company with banks are in agreement with the books of accounts except incase of quarter ended March 31, 2022 where the Company has filed provisional statement with the bank and the final statement will be submitted to the bank after finalization of the audited financial statements.

57. During the financial year ended March 31, 2022, the Company has reclassified following comparatives. These reclassifications are primarily to conform to the current years classification, which do not have material impact on the Standalone Financial Statements.

(₹ in Crore)

Note No.	Note Description	Previously	Revised Amount	Change
a)	Balance Sheet			
21B	Other financial liabilities (current)	1,402	937	(465)
18B	Current borrowings	4,290	4,755	465
b)	Statement of Profit and Loss			
28	Cost of Materials Consumed	27,324	27,178	(146)
37	Other Expenses	4,361	4,507	146

As per our report annexed

**For Price Waterhouse & Co Chartered Accountants LLP**  
Firm Registration Number: 304026E/ E-300009

**Sarah George**  
Partner  
Membership No. 045255

Place : Mumbai  
Dated : May 26, 2022

For and on behalf of the Board of **Hindalco Industries Limited**

**Praveen Kumar Maheshwari**  
Whole-time Director &  
Chief Financial Officer  
DIN-00174361

**Anil Malik**  
Company Secretary

**Satish Pai**  
Managing Director  
DIN-06646758

**K N Bhandari**  
Director  
DIN No.: 00026078





# Independent Assurance Statement on Integrated Report



Ernst & Young Associates LLP  
5th Floor, Block B-2  
Nirlon Knowledge Park  
Off. Western Express Highway  
Goregaon (E), Mumbai - 400 063, India

Tel: +91 22 6192 0000  
Fax: +9 22 6192 3000  
ey.com

Building a better  
working world

## The Management and Board of Directors

Hindalco Industries Limited,  
Mumbai, India

## Scope

Ernst & Young Associates LLP (EYA LLP) have been engaged by Hindalco Industries Limited to perform a 'Type 1 Moderate' level of assurance, as defined by AccountAbility Assurance Standard (AA1000 AS v3) and Limited Assurance, as defined by International Standards on Assurance Engagements (ISAE 3000), hereafter referred to as the engagement, for Hindalco Industries Limited's Sustainability data in Integrated Report FY22, prepared as per the <IR> Integrated Reporting Framework by International Integrated Reporting Council (IIRC), (the "Subject Matter") for the period from 01st April 2021 to 31st March 2022.

Other than as described in the preceding paragraph, which sets out the scope of our engagement, we did not perform assurance procedures on the remaining information included in the Report, and accordingly, we do not express a conclusion on this information.

## Criteria applied by Hindalco Industries Limited

In preparing the Integrated Report FY 22, Hindalco Industries Limited applied, the <IR> Integrated Reporting Framework by International Integrated Reporting Council (IIRC) and Global Reporting Initiative (GRI) 2021 Standards, specifically designed for Integrated Report FY22; As a result, the subject matter information may not be suitable for another purpose.

## Hindalco Industries Limited's Responsibilities

Hindalco Industries Limited management is responsible for selecting the Criteria, and for presenting the due to fraud or error.

## EY's Responsibilities

Our responsibility is to express a conclusion on the presentation of the Subject Matter based on the evidence we have obtained.

We conducted our engagement in accordance with the International Standard for Assurance Engagements Other Than Audits or Reviews of Historical Financial Information ('ISAE 3000'), and third edition of AccountAbility's AA1000 Assurance Standard (AA1000 AS v3). The terms of reference for this engagement as agreed with Hindalco Industries Limited on 20<sup>th</sup> March 2020. Those standards require that we plan and perform our engagement to obtain 'Type 1, Moderate' level of assurance (as per AA1000 AS v3) whether, in all material respects, the Subject Matter is presented in accordance with the Criteria, and to issue a report. The nature, timing, and extent of the procedures selected depend on our judgment, including an assessment of the risk of material misstatement, whether due to fraud or error.

We believe that the evidence obtained is sufficient and appropriate to provide a basis for our limited assurance conclusions.



## Our Independence and Quality Control

We have maintained our independence and confirm that we have met the requirements of the Code of Ethics for Professional Accountants issued by the International Ethics Standards Board for Accountants, and have the required competencies and experience to conduct this assurance engagement

EY also applies International Standard on Quality Control 1, Quality Control for Firms that Perform Audits and Reviews of Financial Statements, and Other Assurance and Related Services Engagements, and accordingly maintains a comprehensive system of quality control including documented policies and procedures regarding compliance with ethical requirements, professional standards, and applicable legal and regulatory requirements.

## Description of procedures performed

Procedures performed in a limited assurance engagement vary in nature and timing from and are less in extent than for a reasonable assurance engagement. Consequently, the level of assurance obtained in a limited assurance engagement is substantially lower than the assurance that would have been obtained had a reasonable assurance engagement been performed. Our procedures were designed to obtain a limited level of assurance on which to base our conclusion and do not provide all the evidence that would be required to provide a reasonable level of assurance.

Although we considered the effectiveness of management's internal controls when determining the nature and extent of our procedures, our assurance engagement was not designed to provide assurance on internal controls. Our procedures did not include testing controls or performing procedures relating to checking aggregation or calculation of data within IT systems.

A limited assurance engagement consists of making enquiries, primarily of persons responsible for preparing the sustainability report and related information and applying analytical and other appropriate procedures

Our procedures included:

- Conducted interviews with select personnel at manufacturing units and corporate teams to understand the process for collecting, collating and reporting the subject matter as per Global Reporting Initiative (GRI) Standards;
- Checked that the calculation criteria have been correctly applied in accordance with the methodologies outlined in the Criteria;
- Undertook analytical review procedures to support the reasonableness of the data
- Verification of sample data and related information through virtual consultations with site team and, desk reviews of the following locations:
  - Aditya Aluminum
  - Bagru mine cluster (Bagru, Bhusar, Hisri old and Hisri new)
  - Muri works
  - Talaja Unit
  - Birla Copper
- Review of data on sample basis, of the entities listed above pertaining to the following specific disclosures of the GRI Standards:
  - General Disclosures (102-1 to 102-56)
  - Environmental Indicators: Materials (301-1, 301-2), Energy (302-1, 302-3, 302-4), Water and Effluents (303-1, 303-2, 303-3, 303-4, 303-5), Biodiversity (304-1, 304-2, 304-3, 304-4), Emissions (305-1, 305-2, 305-4, 305-5, 305-6, 305-7), Waste (306-1, 306-2, 306-3, 306-4, 306-5), Supplier Environmental Assessment (308-1)
  - Social Indicators: Employment (401-1, 401-2, 401-3), Labor/Management Relations (402-1), Occupational Health and Safety (403-1, 403-2, 403-3, 403-4, 403-5, 403-6, 403-7, 403-8, 403-9, 403-10), Training and Education (404-1, 404-2, 404-3), Diversity and Equal

# Independent Assurance Statement on Integrated Report



Opportunity (405-1, 405-2), Non-discrimination (406-1), Freedom of Association and Collective Bargaining (407-1), Child Labor (408-1), Forced or Compulsory Labor (409-1), Security Practices (410-1), Human Rights Assessment (412-1, 412-2), Local Communities (413-1), Supplier Social Assessment (414-1), Customer Health and Safety (416-1), Marketing and Labeling (417-1)

- Execution of an audit trail of claims and data streams, on a selective test basis, to determine the level of accuracy in collection, transcription and aggregation processes followed.
- Review of the Company's plans, policies and practices, pertaining to their social, environment and sustainable development, so as to be able to make comments on the fairness of reporting.
- Review of the Company's approach towards materiality assessment disclosed in the Report to identify relevant issues
- Review of select qualitative statements in various sections of the Integrated Report FY22

We also performed such other procedures as we considered necessary in the circumstances

## Emphasis of matter

The assurance scope excludes:

- Data and information outside the defined reporting period (1<sup>st</sup> April 2021 to 31<sup>st</sup> March 2022)
- Data and information on economic and financial performance of the Company
- Data, statements and claims already available in the public domain through Annual Report, Integrated Report, or other sources available in the public domain
- The Company's statements that describe the expression of opinion, belief, inference, aspiration, expectation, aim or future intention provided by the Company
- The Company's compliance with regulations, acts, guidelines with respect to various regulatory agencies and other legal matters

## Our Conclusion

On the basis of our review scope and methodology to obtain 'Type 1, Moderate' level of assurance (as per AA1000 AS v3) our conclusions are as follows:

- **Inclusivity:** The Company has described its stakeholder engagement approach and activities in the Report. We are not aware of any matter that would lead us to conclude that the Company has not applied the principle of inclusivity in engaging with the key stakeholder groups identified in the Report.
- **Materiality:** The Company has identified key issues material to its ability to create value and has described the process for materiality analysis in the Report. Nothing has come to our attention that causes us to believe that material issues so identified have been excluded from the Report by the Company.
- **Responsiveness:** We are not aware of any matter that would lead us to believe that the Company has not applied the responsiveness principle in its engagement with stakeholders identified in the Report on material aspects covering its sustainability performance.
- **Impact:** As per the information provided to us, we are not aware of any matter that would lead us to conclude that the criteria related to the impact principle has not been applied for the key stakeholders.

Based on our procedures and the evidence obtained, we are not aware of any material modifications that should be made to the Integrated Report FY 22 for the period from 01st April 2021 to 31st March 2022, in order for it to be in accordance with the <IR> Integrated Reporting Framework of International Integrated Reporting Council (IIRC) and GRI 2021 Standards.



## Restricted use

- This report is intended solely for the information and use of Hindalco Industries Limited and is not intended to be and should not be used by anyone other than Hindalco Industries Limited.

For Ernst & Young Associates LLP

By:

**Chaitanya Kalia**  
Engagement Partner  
27<sup>th</sup> July 2022  
Mumbai, India





## Hindalco Industries Limited

Registered Office:

Ahura Centre, 1<sup>st</sup> Floor, B Wing, Mahakali Caves Road, Andheri (East), Mumbai-400 093.

Tel: (91-22) 6691 7000 | Fax: (91-22) 6691 7001

E-mail: [hilinvestors@adityabirla.com](mailto:hilinvestors@adityabirla.com)

Website: [www.hindalco.com](http://www.hindalco.com)

CIN No. L27020MH1958PLC011238