

RAMKRISHNA FORGINGS LIMITED

Date: 28 February, 2023

To
The Listing Department
BSE Limited
PJ Towers
Dalal Street
Mumbai - 400 001

To
The Listing Department
National Stock Exchange of India Limited
"Exchange Plaza" C-1, Block G
Bandra- Kurla Complex, Bandra (E)
Mumbai- 400051

BSE SCRIP CODE: 532527

NSE SYMBOL: RKFORGE

Dear Sir / Madam,

Sub: Disclosure under Regulation 30 of the SEBI (Listing Obligations and Disclosure Requirements) Regulations, 2015 - Revision of Intimation of schedule of Analyst/Institutional Investor Meet/Call

In reference to the above captioned subject and our earlier letter dated 27 February, 2023, this is to inform you that the Management of the Company will be **attending in Person "Investec India Promoter Conference"** on Thursday, 2 March, 2023 instead of **virtual meeting**.

Note: The above schedule meeting may undergo changes due to exigencies on the part of the investor or the Company.

Please note that no unpublished Price sensitive information is proposed to be shared during the Meeting.

Further, enclosed herewith presentation which will be made at the aforesaid meeting.

Request to kindly take the same into record.

Thanking you.

Yours truly,
For Ramkrishna Forgings Limited

Rajesh Mundhra
Company Secretary: ACS12991

Encl.: As above



REGISTERED & CORPORATE OFFICE

23 CIRCUS AVENUE, KOLKATA 700017, WEST BENGAL, INDIA

PHONE : (+91 33)4082 0900 / 7122 0900, FAX : (+91 33)4082 0998 / 7122 0998, EMAIL : info@ramkrishnaforgings.com, WEB : www.ramkrishnaforgings.com

CIN NO. :L74210WB1981PLC034281



Ramkrishna Forgings Limited





About Ramkrishna Forgings

One of the largest forging player in India



Key Highlights



Manufacturer and supplier of a variety of auto and non-auto components



Global presence with footprints in North America and Europe

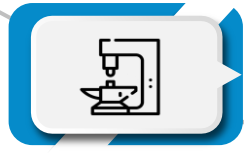

2nd largest forging player in India with over 30 years of experience



Promoter possessing multi-decade forgings industry experience



Continued focus on diversification with foray into EV



Longstanding relationship with marquee customers

Vision, Mission & Core Values

Vision

To be the most dependable and preferred supplier of forged and rolled components for the railways, automobile, mining, earthmoving, oil exploration, farm equipment, bearing and general engineering industry by providing world class products at competitive prices through a knowledge-based organization

Mission

Create value for all business associates, shareholders and customers in all the areas of business in which we are associated with and to become an active partner in employee well-being and philanthropic causes

Core Values

Customer centric approach
Continual improvements in systems
Commitment to human development

... with over four decades of unique capabilities

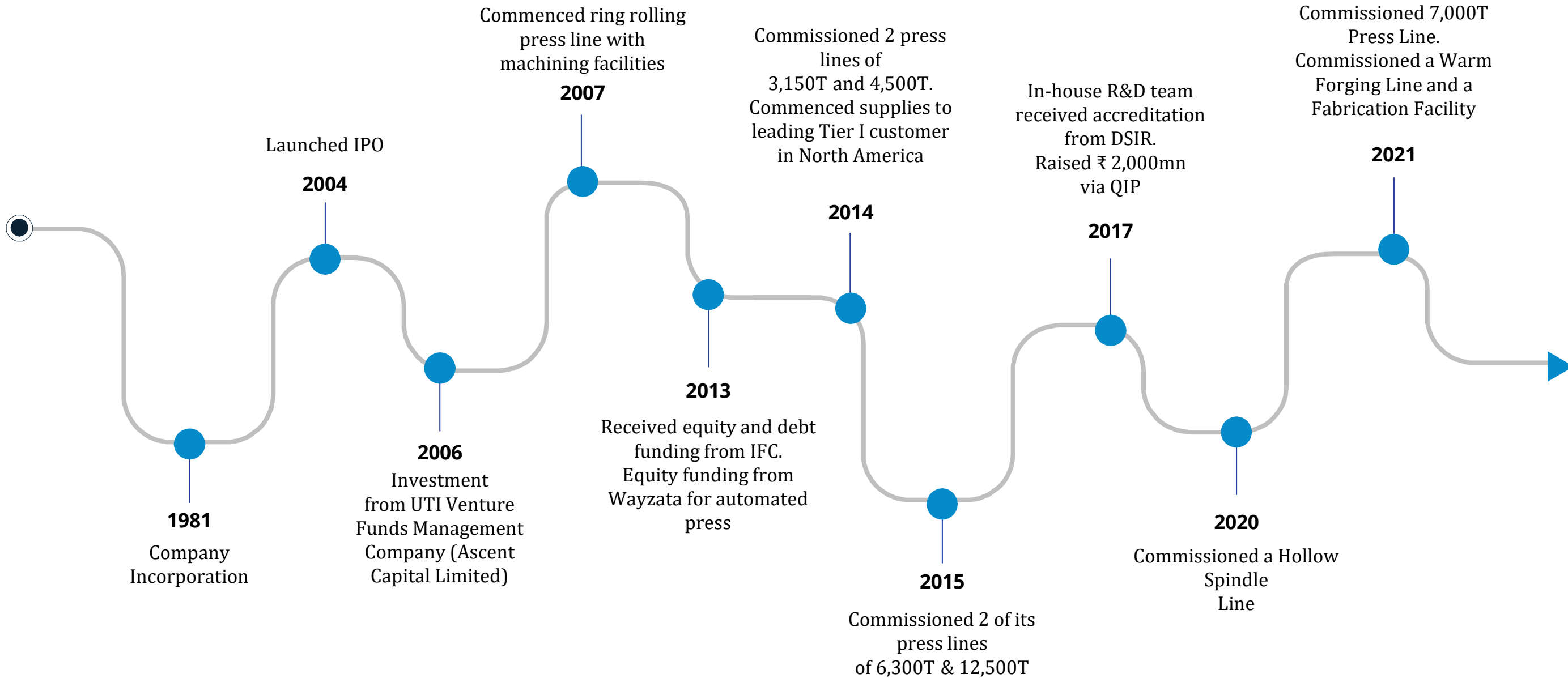

... with state of the art manufacturing facilities



Ring Rolling

- Ring Rolling facility with robotics which can roll crown wheels upto 500mm diameter and a capacity to forge components from 15-70 kgs
- Ability to forge one component in 25-40seconds



Press

- First company in India to have fully automated 12,500T wedge press line
- Capability to manufacture complex and heavy forged components



Machined

- State of the art machinery and capabilities which includes turning Center, gear hobbing, shaping, shaving and broaching.

1 6 large modern facilities in India >> Strategic location benefits coupled with economies of scale

2 Technology led operations better solutions, optimum yield and enhanced quality of products

3 Extensive manufacturing capabilities >> Ability to manufacture diverse products

4 Agile, flexible operations >> Customized customer centric solutions

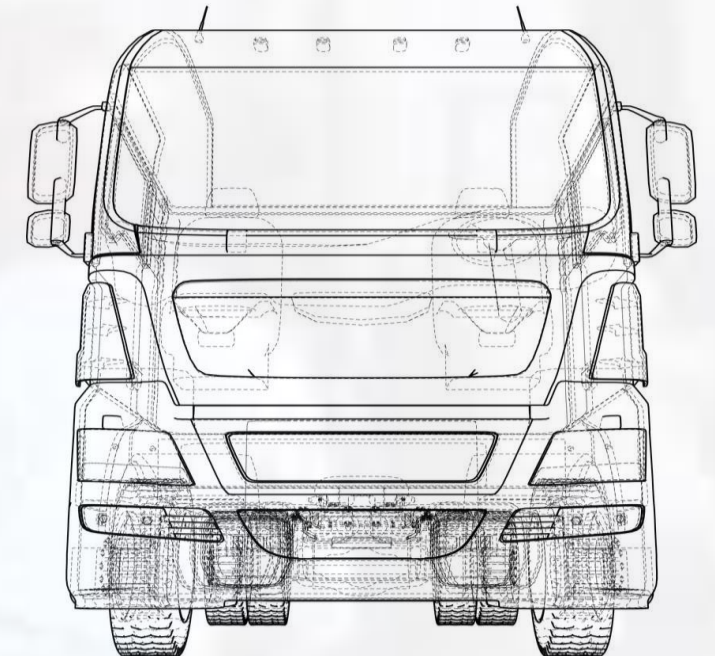

... at strategic locations giving us competitive edge

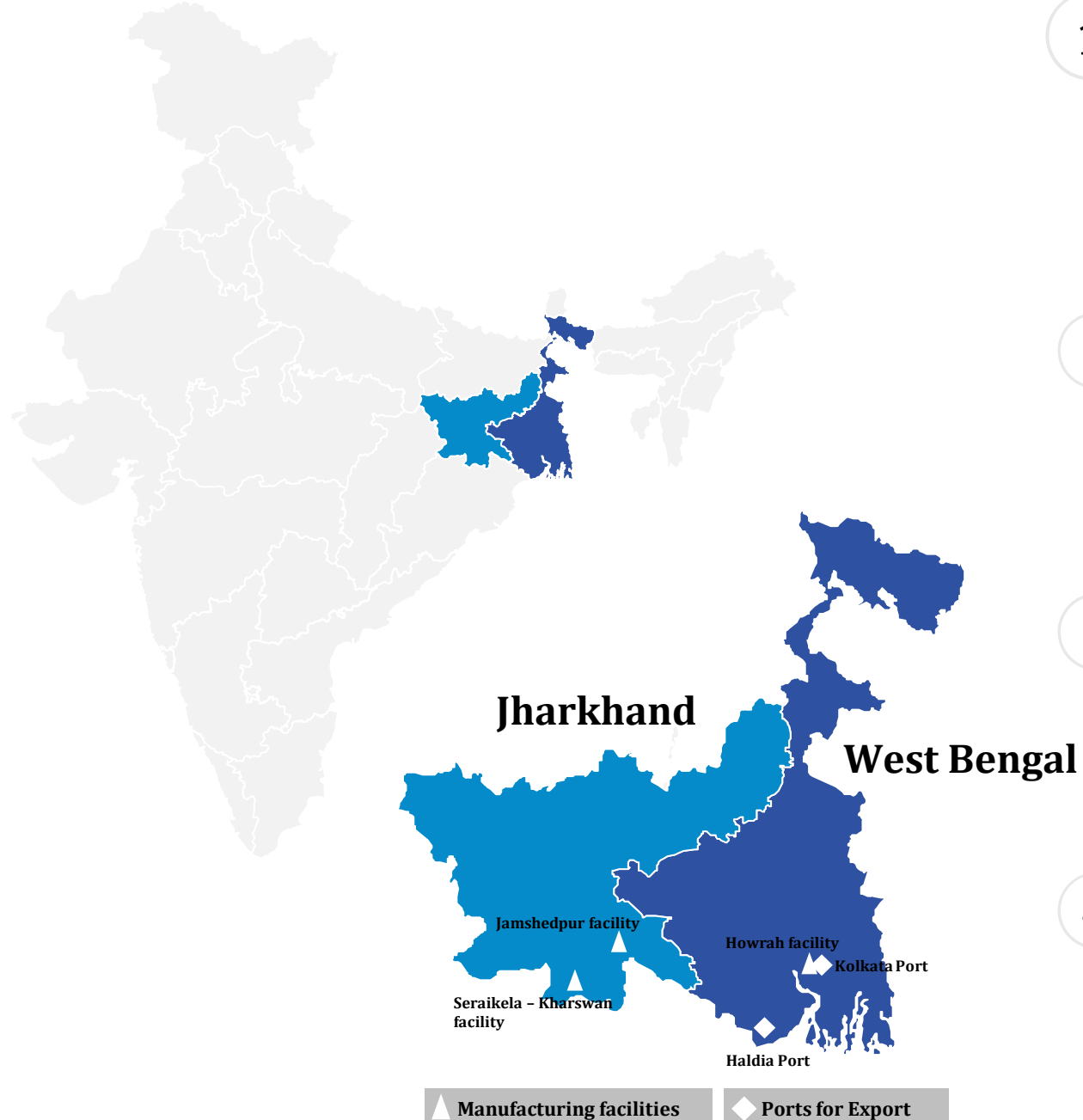

1

Proximity to automobile manufacturing hubs & key suppliers

- RKFL's facilities in eastern India are located in close proximity to automobile manufacturing hubs and key suppliers of raw material
 - Less chance of supply interruptions
 - Lower logistics cost
 - Reduced working capital requirements

2

All facilities located within the same region

- Better integration resulting in efficient processes
- Improved coordination
- Overall cost savings, including administrative costs

3

Proximity to key export hubs

- Reduces logistics cost
 - 302km* to Kolkata port
 - 270km* to Haldia port

4

Availability of labor

- Eastern region is the industrial center of India
- Low cost labor easily available
- Lower dependency on migrant laborers

*approximate distance from Jamshedpur facility

... demonstrating superior performance*



17

Countries Served

1,87,100

Installed Capacity

77.2%

Capacity Utilisation

1,11,742

Sales Volume
↑ 42% YoY

₹ 2,285 cr

Revenue
↑ 77% YoY

43.3%

Export Revenue Mix
↑ 7.8% YoY

2%

Total Turnover
from EV

₹ 527 cr

EBITDA
↑ 129% YoY

23.1%

EBITDA Margin

14.7%

ROCE

18.9%

ROE

2.5x

Net Debt to EBITDA

*As on 31st March 2022 on standalone financials

... offering diversified products

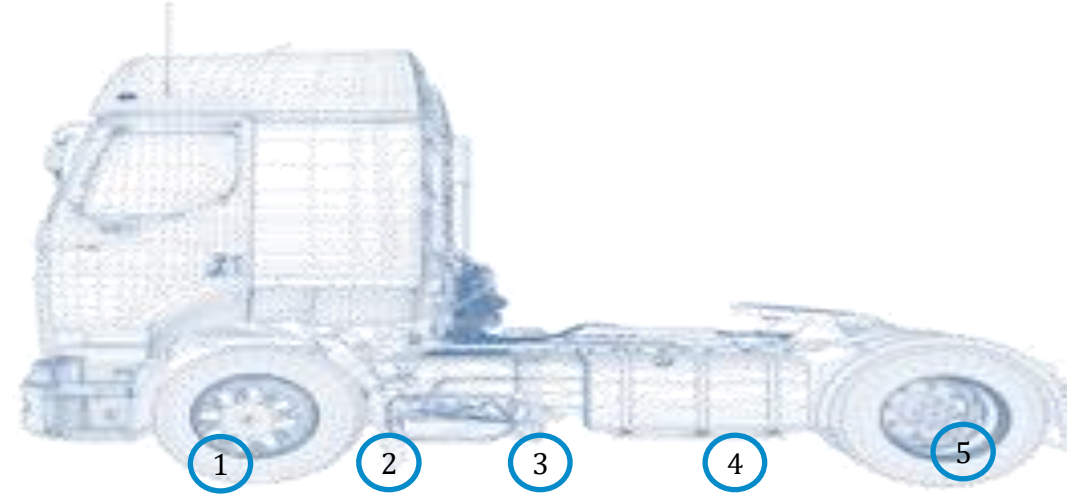

1 Front Axle & Steering



2 Engine



3 Suspension & Chassis

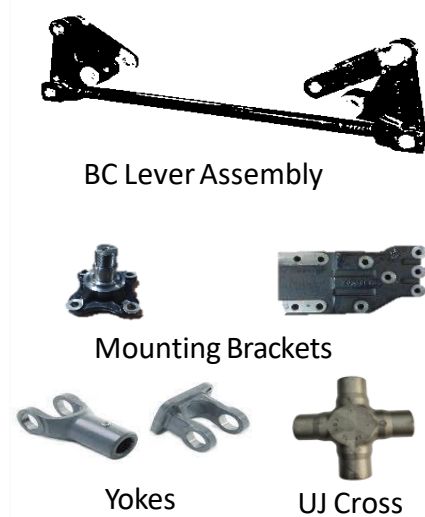

4 Transmission



5 Rear Axle



... across diversified segments

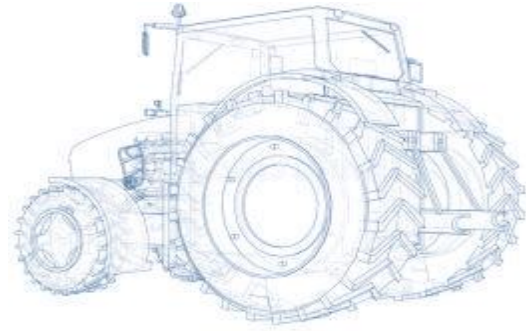

Tractors & Tillers



1,2,3 & 4 Cyl Forged Crankshafts



Crown Wheel & Pinion



Rear Axle Shafts



Transmission Shafts & Gears

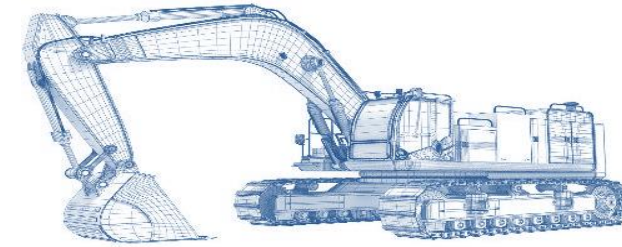

Earth Moving



Bucket



Backhoe Bucket



Shovel



Track Link



Track Roller



Bucket Tooth



Pivot Pin



Prop Shaft



Bearing Centre

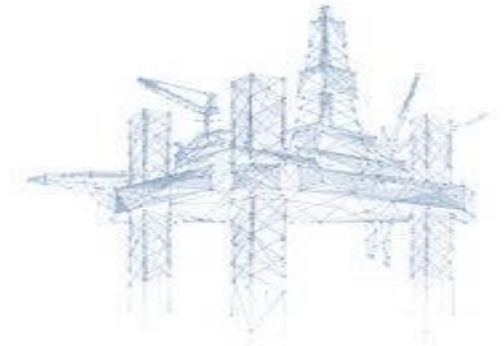
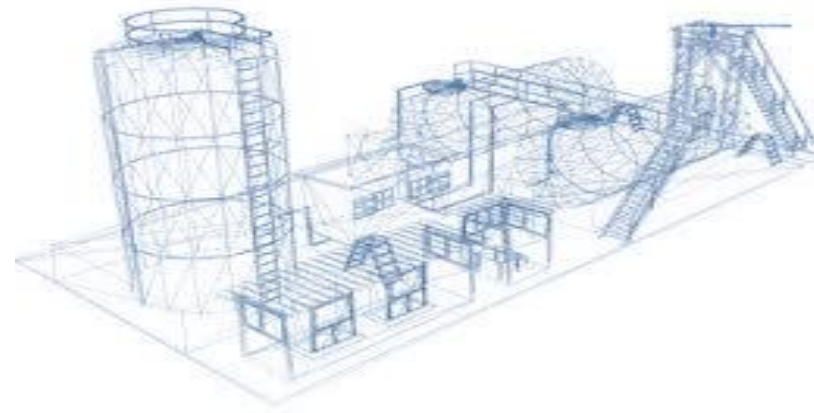
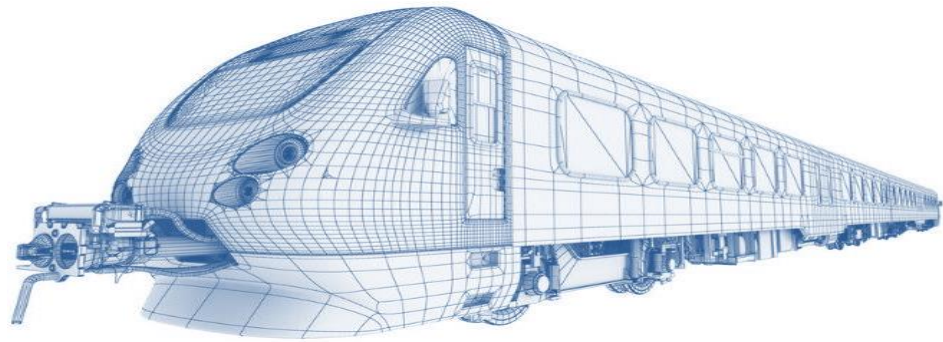

Railways



Bogie Frame



Bogie Bolster



Draw Gear Assembly



Screw Coupling



Hanger

Anti Roll Bar Assembly

Energy



Wing Nut



Valve Bonnet



T Bolt Socket Joint



Toothed Crusher Hammer

... with growing global footprints



Headquarters & Manufacturing facilities

- Headquarters – Kolkata
- 6 manufacturing facilities
 - Jamshedpur – 3
 - Serailkela – Kharswan – 2
 - Howrah – West Bengal – 1



Sales representative office:

- Detroit, USA
- Sao Paulo, Brazil
- Istanbul, Turkey
- Germany
- Italy



Warehousing facility:

- Shelbyville, USA
- Hagerstown, USA
- Monterrey, Mexico
- Toluca, Mexico
- Westerloo, Belgium

*With consistently growing exports **

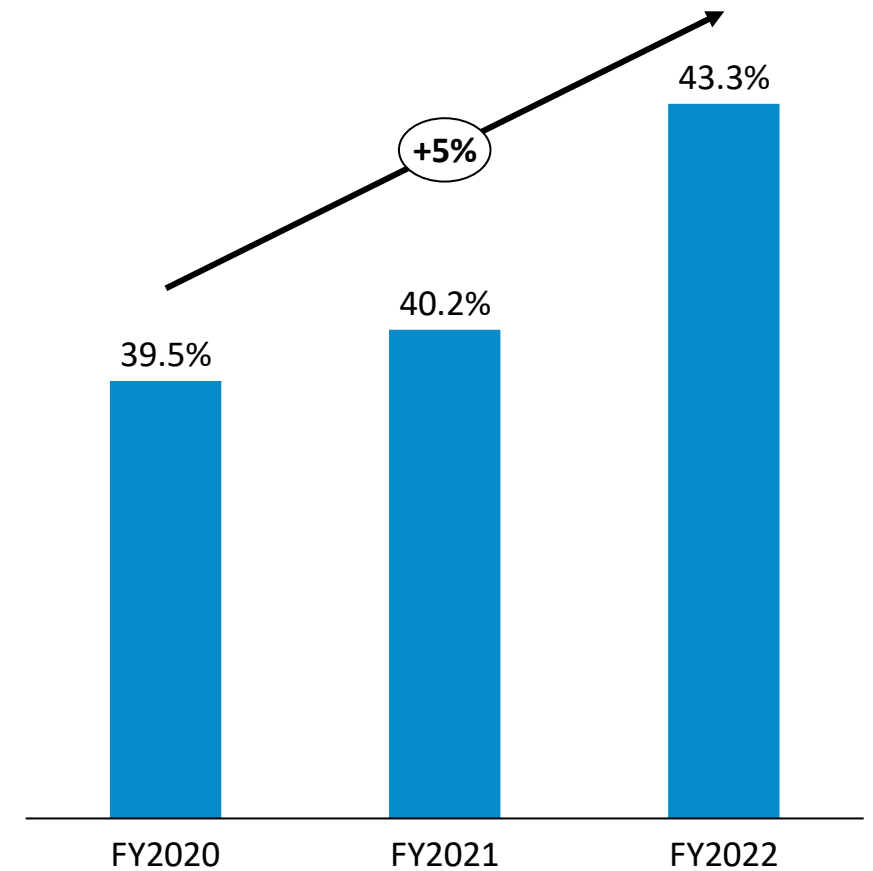

**Exports as a % of total revenue from operations*

...with multiple accreditations & certifications



ISO 9001:2015

QMS



IATF 16949:2016

QMS for Automotive
Production



ISO 14001:2015

Environmental
Management



ISO 45001:2018

Occupational Health and
Safety Management



ISO/TS 22163:2017

Quality & Business
Management Systems for Railways



EN 15085-2:2020

Welding of Railway Vehicles and
Components



A decorative background pattern of light gray triangles arranged in a repeating geometric pattern, fading out towards the right.

Financial Highlights

Strong growth backed by profitability



(₹ in Lakhs)

(Standalone)

Revenue

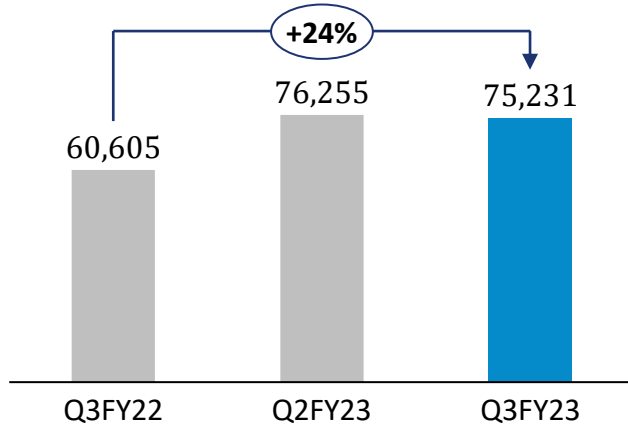

EBITDA* & EBITDA Margin

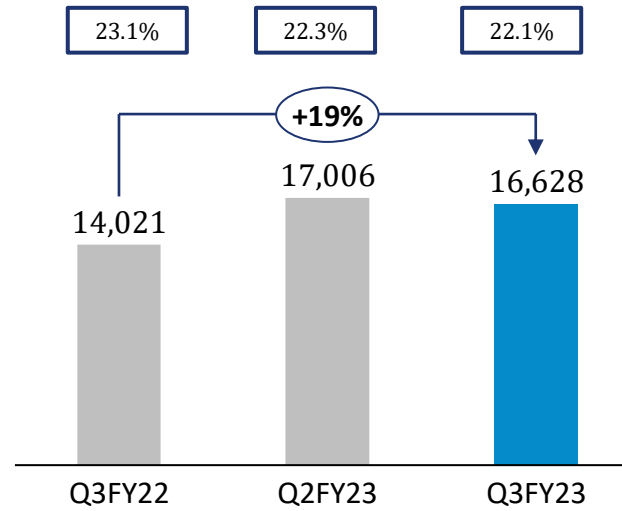

PAT & PAT Margin

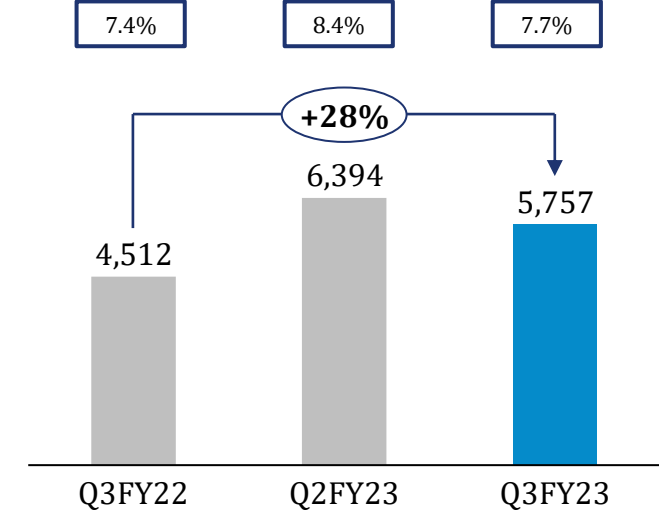

Revenue

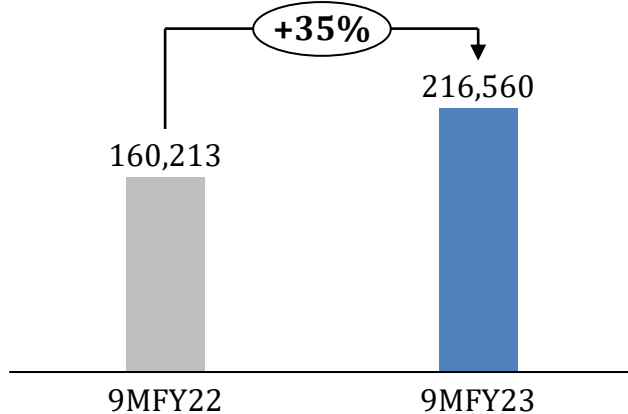

EBITDA* & EBITDA Margin

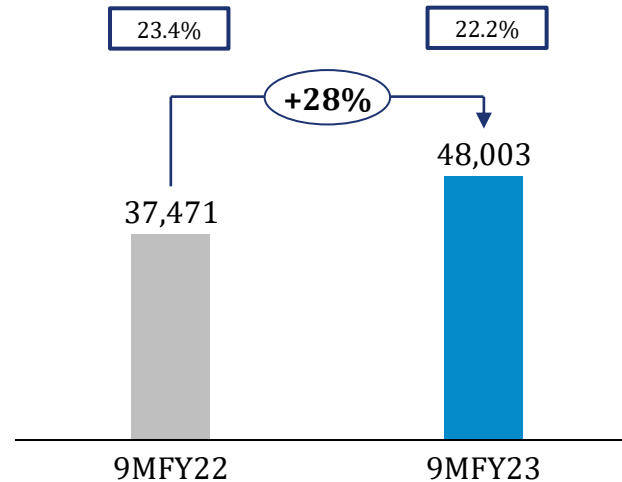

PAT & PAT Margin

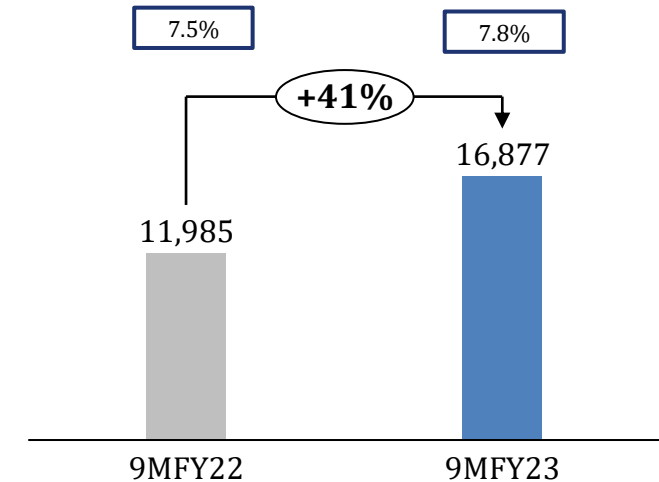

*Excluding Other Income ; Note: Rounded off to the nearest whole number

Strong growth backed by profitability



(Consolidated)

(₹ in Lakhs)

Revenue

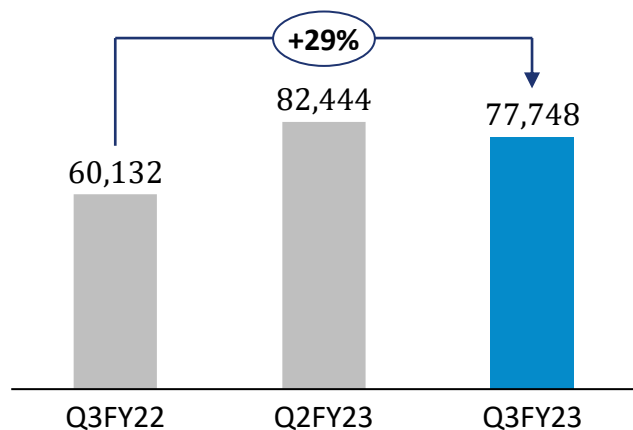

EBITDA* & EBITDA Margin

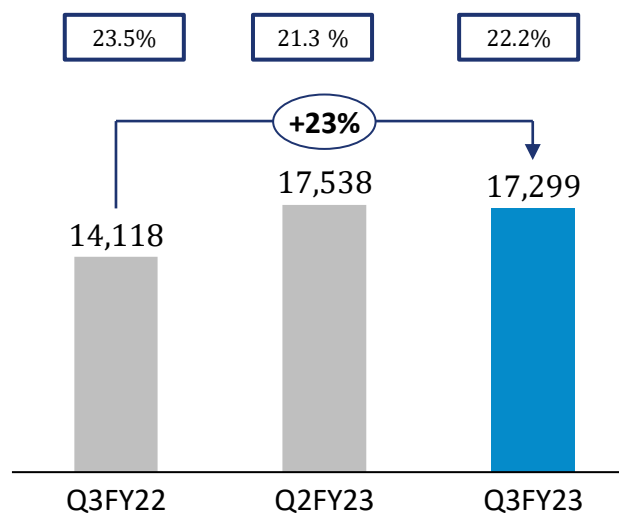

PAT & PAT Margin

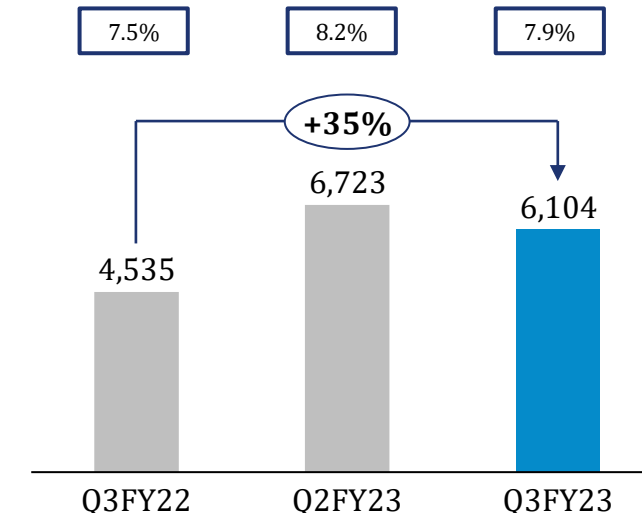

Revenue

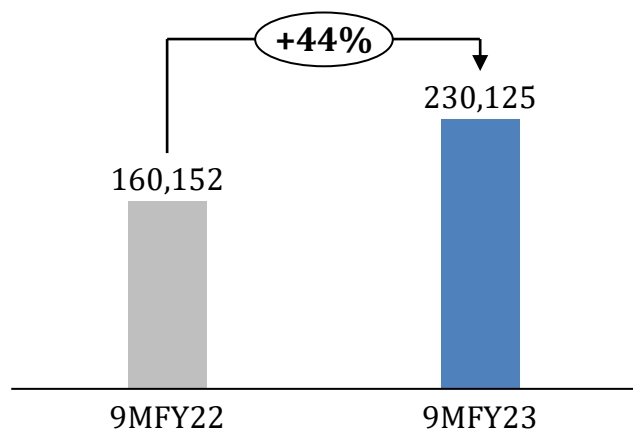

EBITDA* & EBITDA Margin

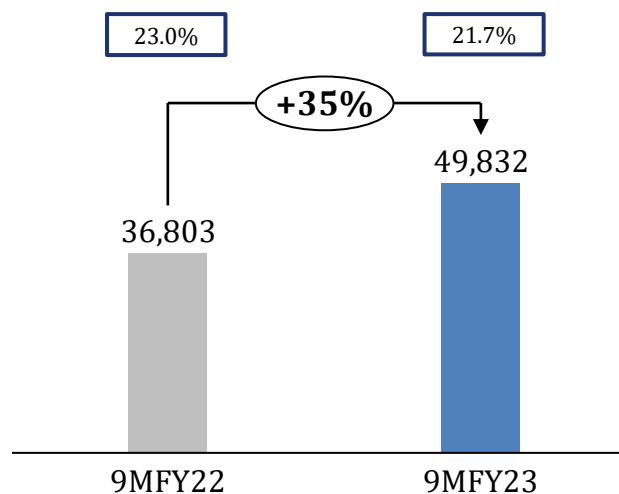

PAT & PAT Margin

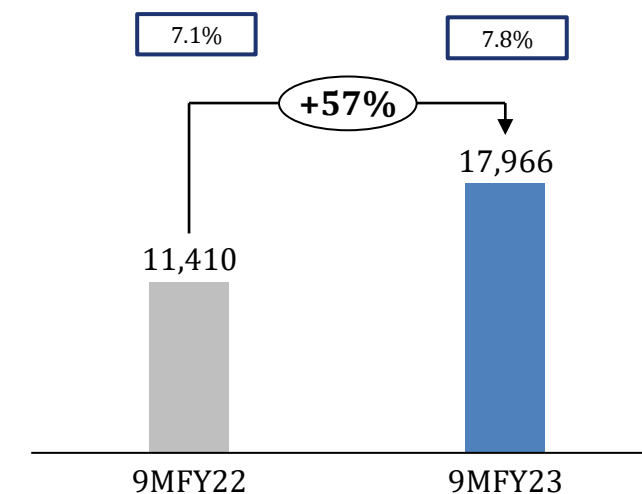

*Excluding Other Income ; Note: Rounded off to the nearest whole number

... coupled with increasing volumes



Volume (tons)

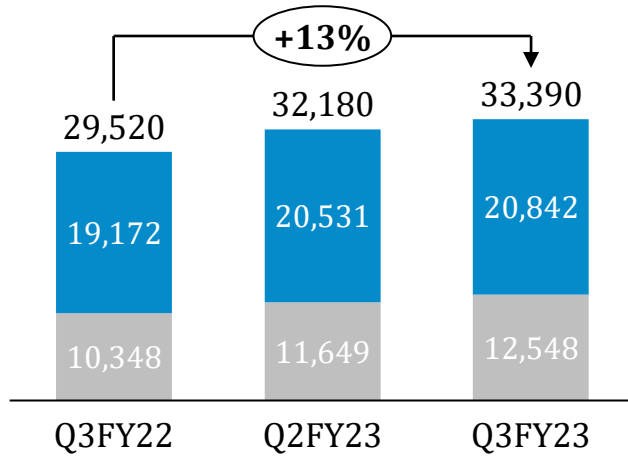

Realisation (Rs. Lac/ (ton))

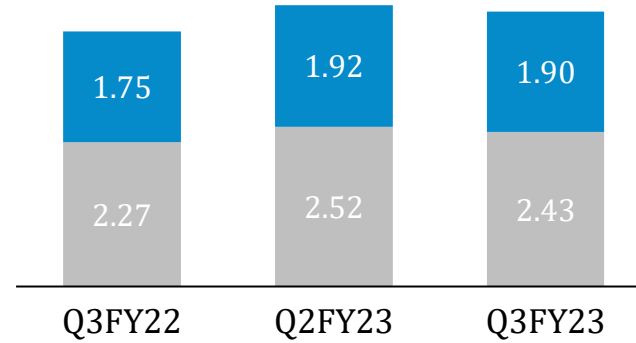

Total Revenue Breakup (Rs. Lakhs.)					
Particulars	Q3FY23	Q3FY22	YoY	Q2FY23	QoQ
Domestic Markets	41,911	34,272	22.3%	43,626	-3.9%
Export Markets	32,691	25,969	25.9%	32,109	1.8%
Other Income	81	168	-51.8%	59	36.0%
Export Incentive	629	365	72.4%	520	21.1%
Total	75,312	60,774	23.9%	76,314	-1.3%

Volume (tons)

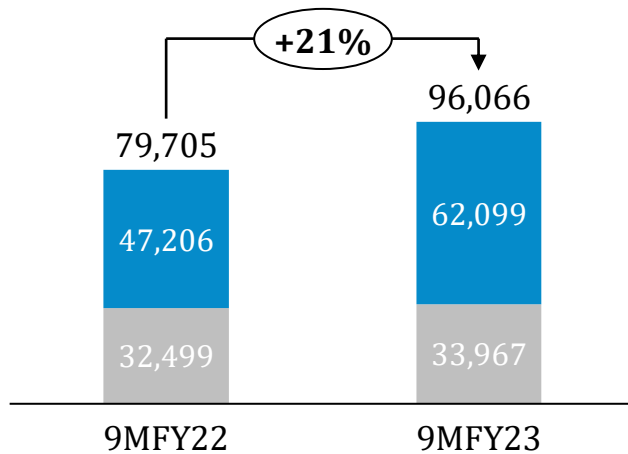

Realisation (Rs. Lac/ (ton))

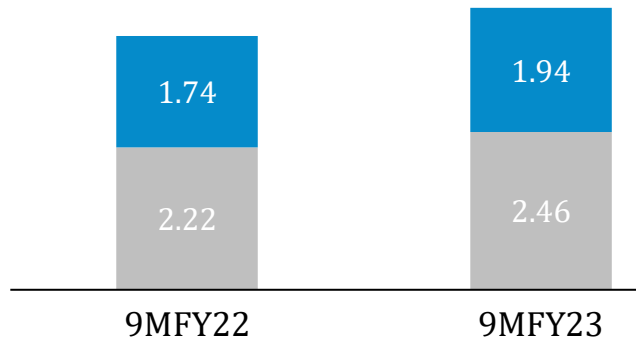

Total Revenue Breakup (Rs. Lakhs.)			
Particulars	9MFY23	9MFY22	YoY
Domestic Markets	125,462	82,328	52.4%
Export Markets	89,539	76,667	16.8%
Other Income	206	285	-27.6%
Export Incentive	1559	1217	28.1%
Total	216,766	160,497	35.0%

■ Domestic Markets* ■ Export Markets**

*Realisation excluding Fabrication sales
** Realisation excluding ocean freight

.... leading to higher utilizations



Particulars	Installed Capacity	Q3FY23		Q2FY23		Q1FY23		Q4FY22		Q3FY22		Q2FY22	
		Production Capacity (MT)	Utilisation (%)*	Production Capacity (MT)	Utilisation (%)*	Production Capacity (MT)	Utilisation (%)*	Production Capacity (MT)	Utilisation (%)*	Production Capacity (MT)	Utilisation (%)*	Production Capacity (MT)	Utilisation (%)*
Ring Rolling	24,000	7,390	123%	7,042	117%	7,018	117%	6,841	114%	6,918	115%	6,990	117%
Forgings	46,000	12,810	111%	11,732	102%	10,963	95%	12,104	105%	10,766	94%	11,606	101%
Press	117,100	19,880	68%	19,696	67%	18,489	63%	19,038	65%	16,473	56%	18,267	62%
Total Capacity	187,100	40,080	86%	38,470	82%	36,470	78%	37,983	81%	34,157	73%	36,863	79%

*Utilization (%) has been calculated on installed capacity on Annualized basis

... with improving key ratios



Gross Margin (%)

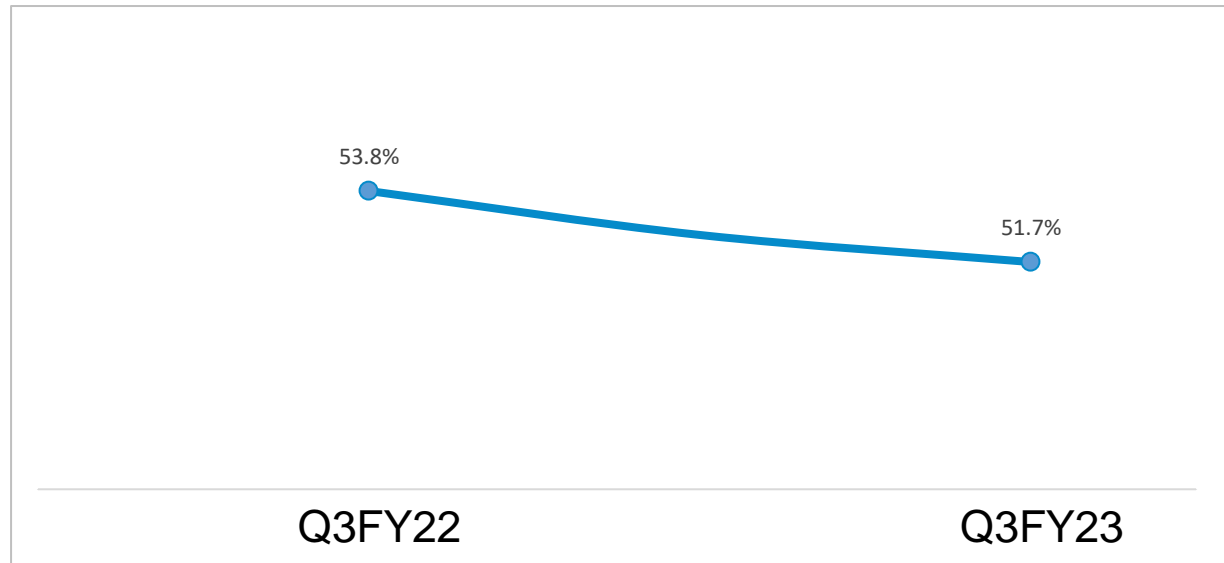

EBIDTA Margin (%)

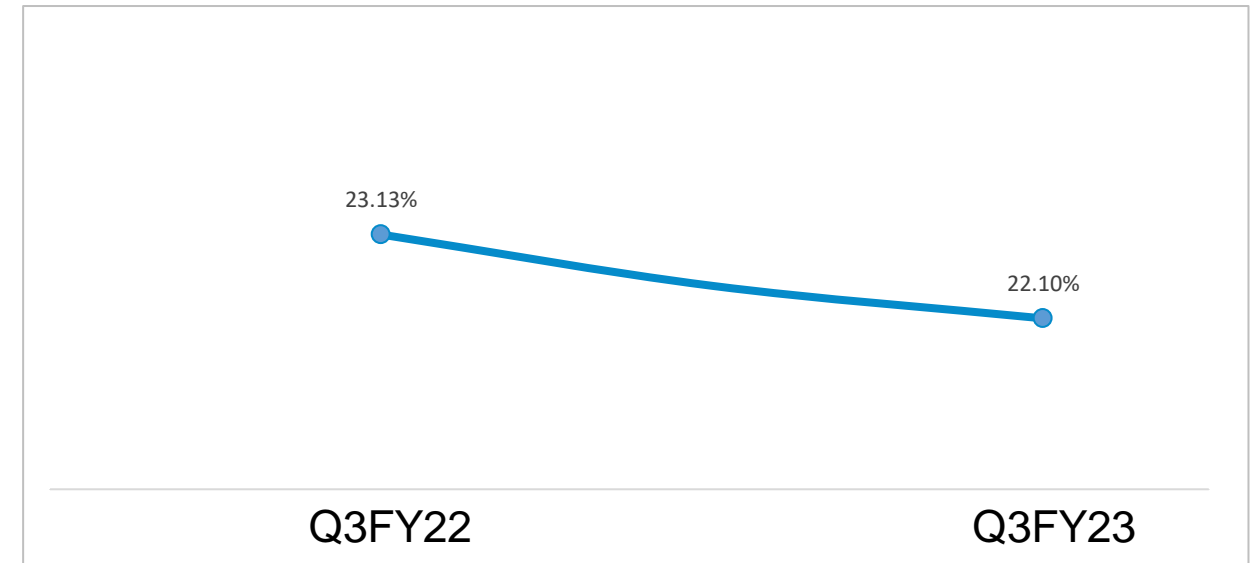

PBT Margin (%)

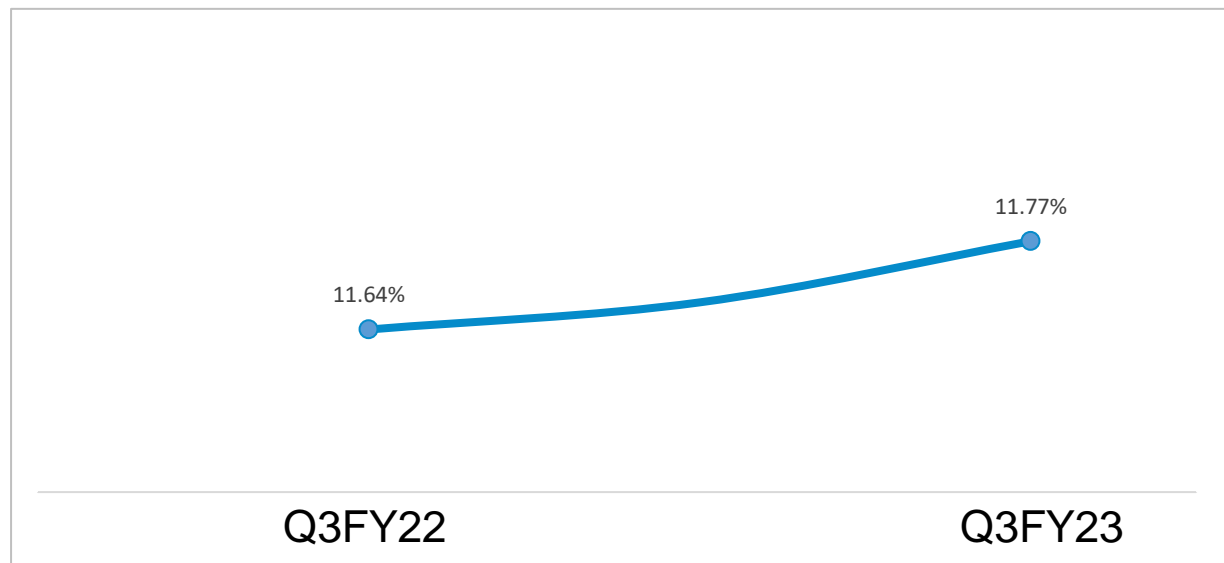

PAT Margin (%)

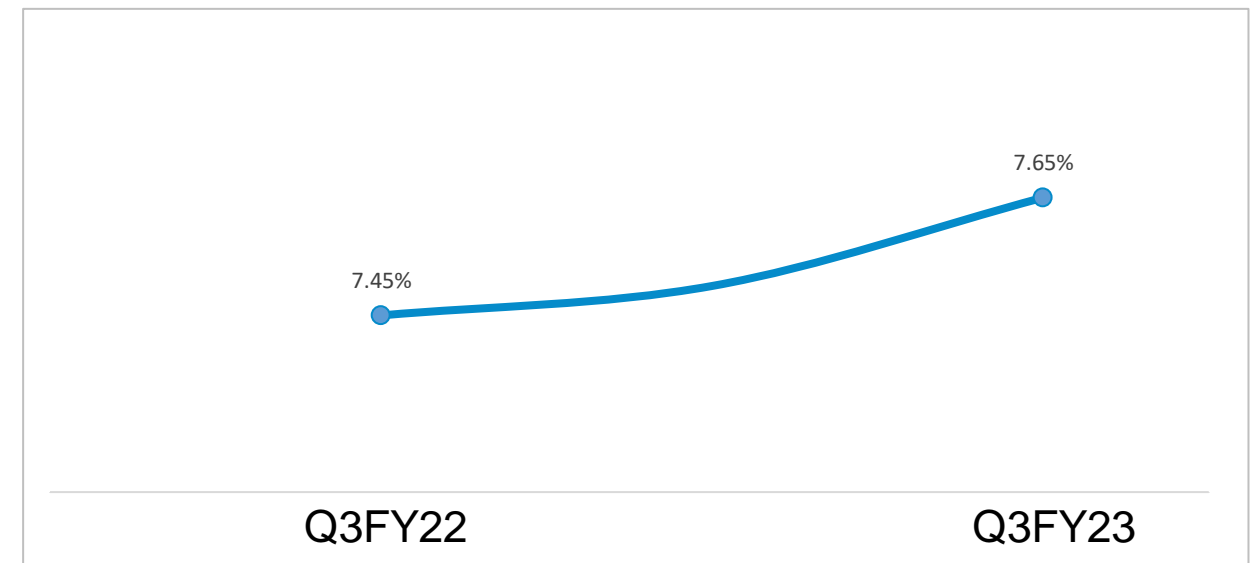

... with improving return ratios

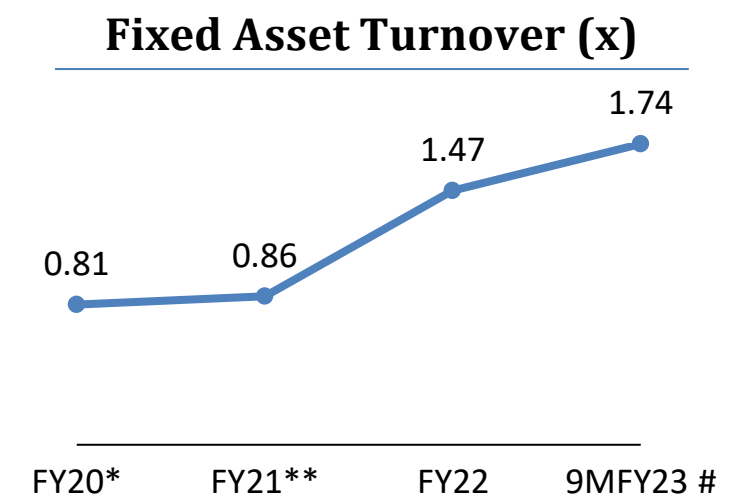
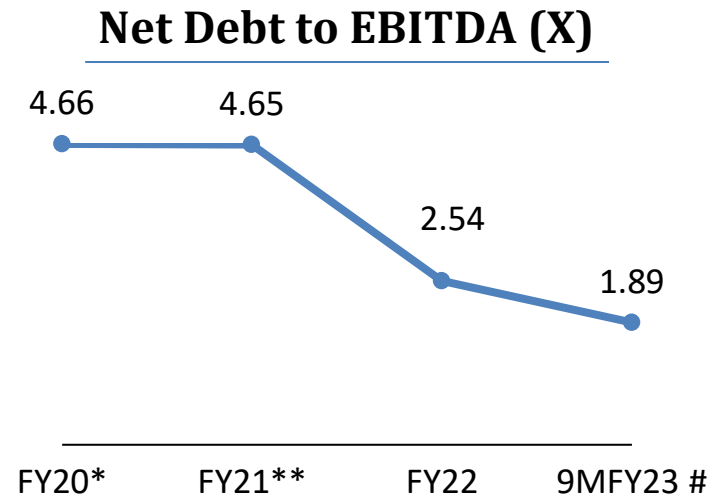
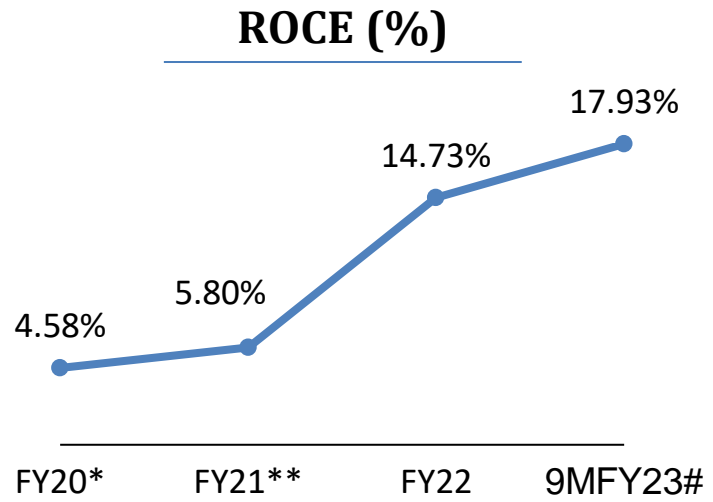

Annualized.

ROCE- EBIT Less Other Income / (Net Debt + Equity)

Net Debt to Equity- Net Debt/ Net worth

FATR- Revenue / Fixed Assets (Net)

*- FY20 Performance impacted due to economic slowdown leading to sluggish demand for CVs

** - FY21 Performance impacted due to COVID-19 induced lockdown

Diversified revenues across segments & geographies



By Geography

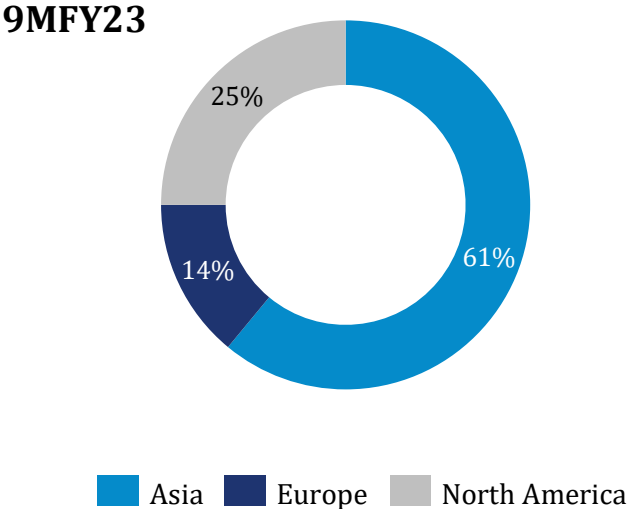

By Segment

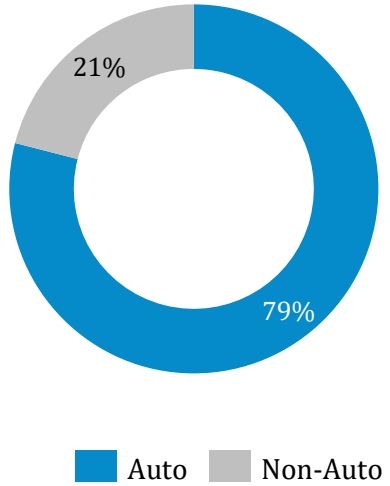

By Industry

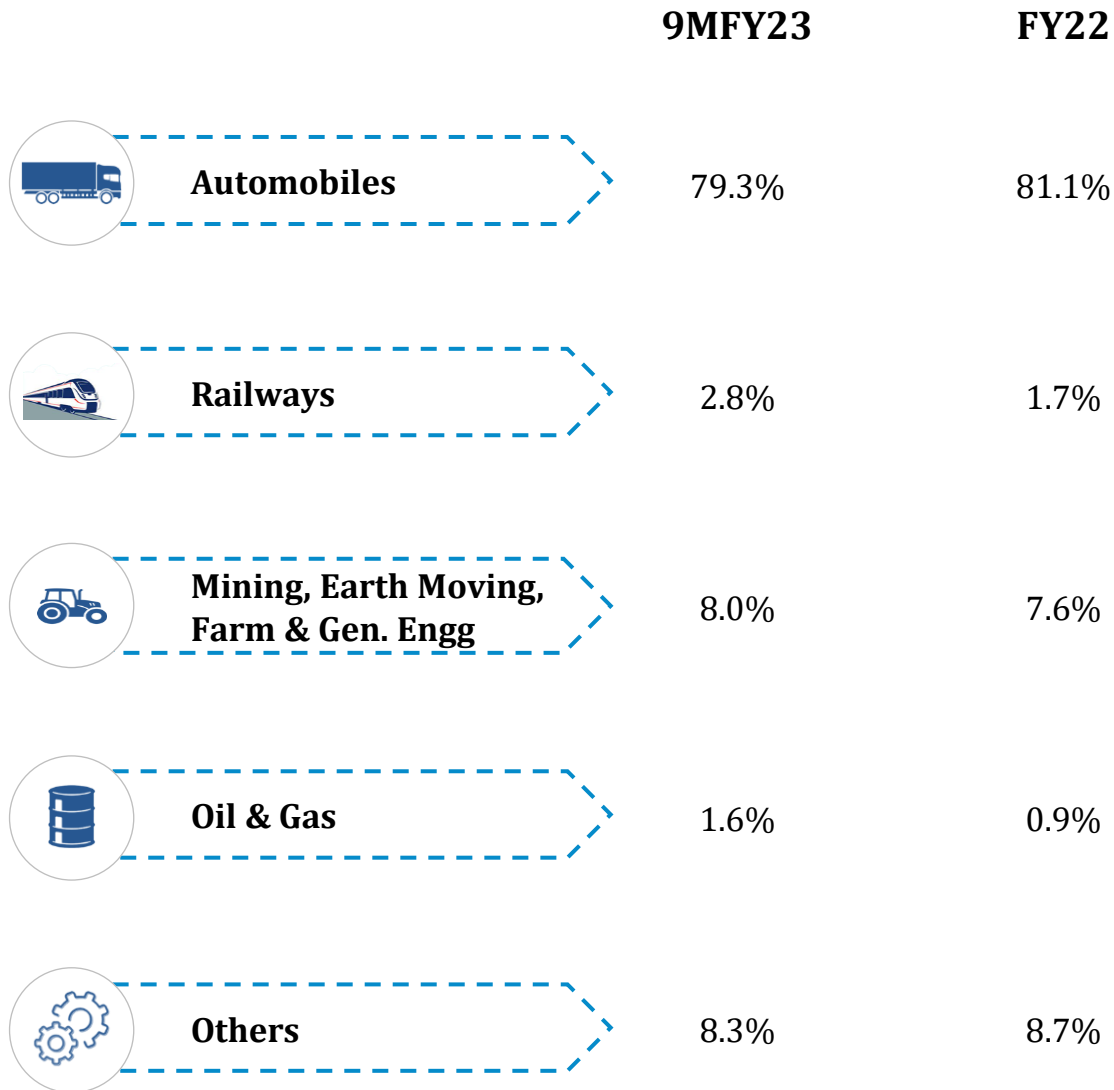

FY22

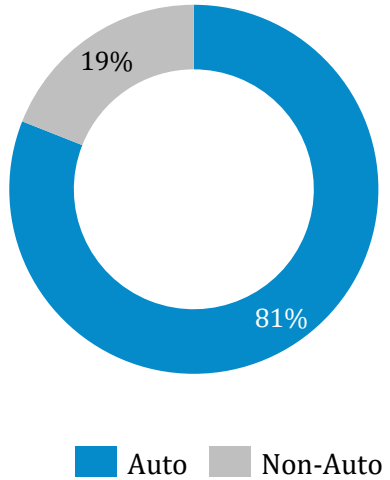
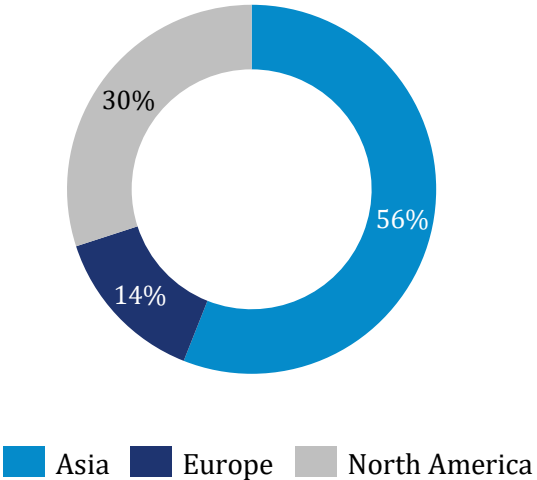

A decorative background pattern of light gray triangles arranged in a repeating geometric lattice, fading out towards the right side of the slide.

Way Forward

Multiple vectors to accentuate growth and increase profit

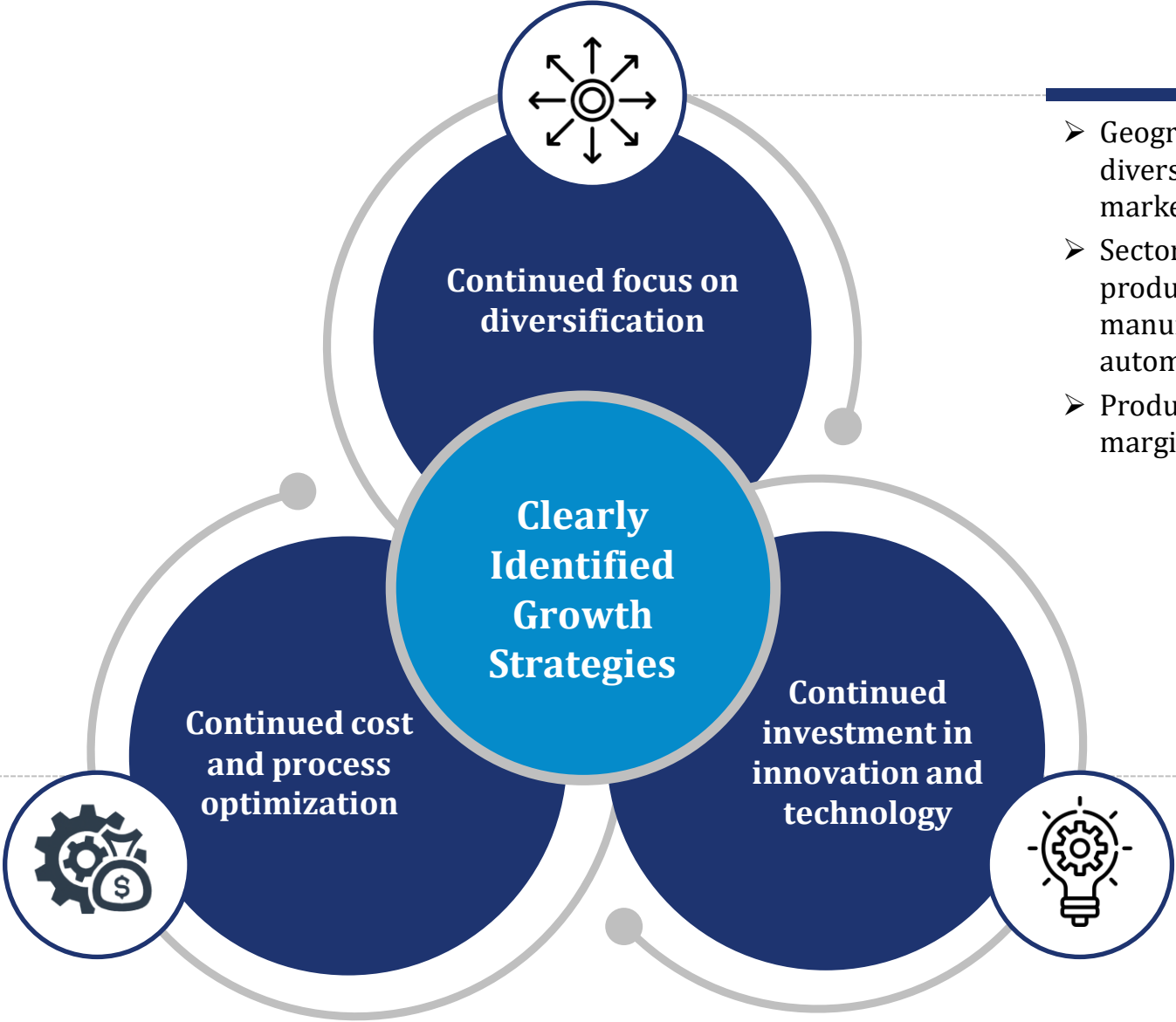

- Geographical – Further diversification into international markets
- Sector – Increasing the gamut of products that are currently manufactured towards non-automotive customers
- Product – Diversification into high margin, niche products and EV

- Accelerated efforts to optimize and improve process efficiency
- Focus on achieving economies of scale

- Enhancing R&D capabilities to further provide competitive edge with respect to quality and cost
- Investment in modern technology and equipments solidifying the competitive edge

Well positioned to capture future growth



- We are adding 56300 Tons capacity.
- Will be ready by the above new Capacities by September 2023 and with this capacities, we will be able to achieve a topline of Rs 5000 Crores (at current commodity price)
- Capacity sufficient for the next phase of growth.
- Capacity ramp-up along with operating leverage will result in faster improvement in profitability.

Installed Capacity

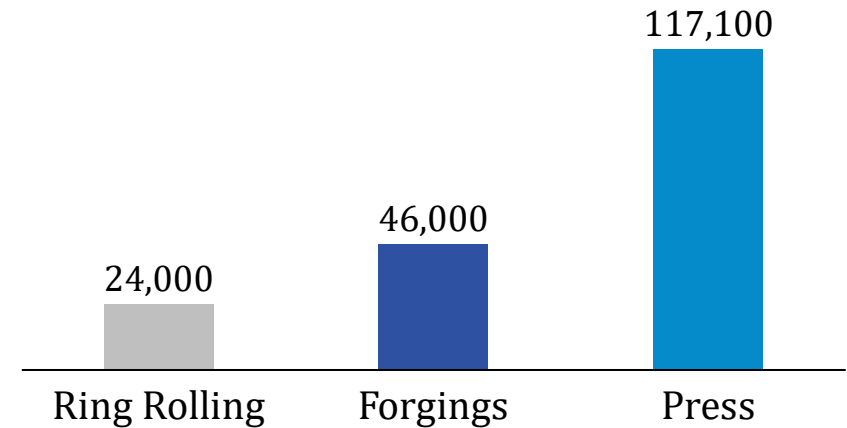

Capacity Utilization*

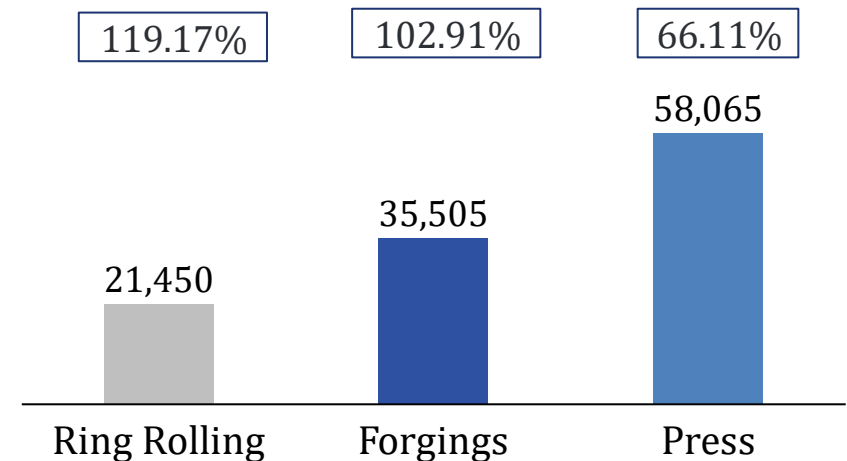

*As on December 31, 2023

Disciplined capital allocation priorities



₹ in Lakhs

Particulars	Mar'22	Dec'22
Long Term Debt (incl. current Maturities of Long Term Debt)	99,185	91,756
Short Term Debt	58,554	36,933
Total Debt	1,57,740	1,28,689

01

The Company expect to achieve a revenue growth of 20% CAGR over a period of next 3 years

The repayment of debt and payment of dividend will be commensurate with increased cash flow in line with the above growth.

02



North America

Europe

India/ASIA Pacific

India / Asia Pacific

3 Customer

✓ 6 Programs

□ 3 Programs

Europe

2 Customer

□ 3 Programs

North America

1 Customer

✓ 5 Programs

□ 4 Programs

✓ Programs in Serial Productions

□ Programs in Order book

□ Swedish OEM awards business worth 15 million Euros for component to their EV truck for European Market to commence their development & supplies till 2030 for the awarded business.

Acquiring Growth: Ramkrishna Forgings to acquire JMT Auto



Details of the acquisition

- Lenders to JMT Auto, a unit of Amtek Auto group, have approved a resolution plan by Ramkrishna Forgings Limited.
- The acquisition plan had been duly approved by 84.61% Committee of Creditors, subject to approval of NCLT Delhi.
- Transfer is expected to be completed within 60 days of the order.
- The acquisition will be financed through internal accruals and debt.



About JMT Auto

- JMT Auto has significant expertise in the auto sector with capabilities in heat treatment and gear
- It also specializes in manufacturing a variety of components for the Oil and Gas industry.
- It is one of the leading producer of over 2000 different components which range from Engine components, gears, shaft, Pins and Pipe Assemblies, among others.

The acquisition will create a larger, more diversified company with increased scale and market reach.

A decorative background pattern of light gray triangles arranged in a repeating geometric lattice, fading out towards the right side of the slide.

Historical Performance

Income Statement



Particulate (₹ in lakhs)	FY20	FY21	FY22
Revenue from Operations	1,11,182	1,28,838	2,28,537
Cost of Material Consumed	55,611	64,083	121,423
Change in Inventories of Finished goods & Work in Progress	(4,938)	157	(18,345)
Cost of services	-	-	-
Purchases of stock-in-trade	-	-	-
Total Raw Material	50,673	64,240	1,03,077
Gross Profit	60,509	64,597	1,25,459
Gross Profit Margin (%)	54.4%	50.1%	54.9%
Employee Expenses	9,424	9,037	12,028
Power and fuel	9,719	9,354	15,240
Other Expenses	20,995	23,214	45,493
EBITDA	20,372	22,993	52,697
EBITDA Margin (%)	18.3%	17.8%	23.1%
Other Income	602	461	161
Depreciation	12,016	11,628	16,906
EBIT	8,957	11,826	35,952
EBIT Margin (%)	8.1%	9.2%	15.7%
Finance Cost	7,515	7,678	9,335
Profit before Tax	1,442	4,148	26,617
Profit before Tax(%)	1.3%	3.2%	11.6%
Tax	480	1,352	5,967
Profit After Tax	961	2,796	20,650
PAT Margin (%)	0.9%	2.2%	9.0%
EPS (As per Profit after Tax)	2.95	1.74	12.91

Balance Sheet



Equity & Liabilities (₹ in lakhs)	FY20	FY21	FY22
Equity			
Equity Share Capital	3,261	3,193	3,198
Other Equity	84,382	85,804	1,06,210
Total Equity	87,643	88,997	1,09,408
Non-Current Liabilities			
Financial Liabilities			
Borrowings	47,903	66,360	85,945
Lease Liabilities	353	378	2,280
Deferred Tax Liabilities	5,945	6,588	7,927
Provisions	-	-	-
Other Non Current Liabilities	1,678	1,699	1,568
Total Non-Current Liabilities	55,878	75,026	97,720
Current Liabilities			
Financial Liabilities			
Borrowings	36,425	54,160	71,794
Lease Liabilities	40	22	429
Trade Payables	20,693	42,916	57,457
Other Current Financial Liabilities	15,791	4,886	3,594
Other current liabilities	759	1,228	2,401
Provisions	534	520	595
Current Tax Liabilities (net)	-	170	213
Total Current Liabilities	74,242	1,03,901	1,36,484
Total Equity & Liabilities	2,17,763	2,67,923	3,43,612

Assets (₹ in lakhs)	FY20	FY21	FY22
Non - Current Assets			
Property, plant and equipment	1,15,732	1,22,183	1,43,394
Capital work-in-progress	21,644	27,202	12,509
Right of use assets	841	1,009	3,058
Goodwill on Amalgamation	-	-	-
Intangible assets	82	79	113
Financial Assets			
Investments	1,930	1,938	1,938
Trade Receivables	371	-	-
Loans	1,350	170	222
Other Financial Assets	71	1,270	1,324
Non-current Tax Assets	250	250	250
Deferred Tax Assets	-	-	-
Other non-current assets	2,232	1,485	5,316
Total Non - Current Assets	1,44,502	1,55,585	1,68,123
Current Assets			
Inventories	35,719	42,994	68,267
Financial Assets			
Investments	-	-	5,500
Trade receivables	30,260	55,993	87,781
Cash and cash equivalents	226	6,659	3,102
Bank balances other than (iii) above	7	22	134
Loans	732	12	112
Other current financial assets	3,231	1,082	3,488
Other current assets	3,072	5,563	7,089
Current Tax Assets	14	14	14
Total Current Assets	73,261	1,12,339	1,75,489
TOTAL ASSETS	2,17,763	2,67,923	3,43,612

Cash Flow



Particulate (₹ in lakhs)	FY20	FY21	FY22
Cash Flow from Operating Activities			
Profit before Tax	1,442	4,148	26,617
Adjustment for Non-Operating Items	-17,667	-18,453	-23,621
Operating Profit before Working Capital Changes	19,109	22,601	50,238
Changes in Working Capital	6,678	-9,394	-41,774
Cash Generated from Operations	25,786	13,207	8,464
Less: Direct Taxes paid	-670	-557	-4,556
Net Cash from Operating Activities	25,116	12,650	3,908
Cash Flow from Investing Activities	-22,493	-22,622	-35,348
Cash Flow from Financing Activities	-2,590	16,405	27,884
Net increase/ (decrease) in Cash & Cash equivalent	33	6,432	-3,556
Add: Cash and cash equivalents as at 1st April	194	226	6,659
Cash and cash equivalents as at 31st March	226	6,659	3,102

A decorative background pattern of light gray triangles arranged in a repeating geometric pattern, fading out towards the right.

Our Commitment

Our Commitments | Q3 2022 Highlights



We understand that our ambitions cannot be achieved in isolation which is why we have aligned all our commitments to United Nations Sustainable Development Goals (SDGs). Within this document we indicate where our activity aligns with specific SDGs, although this is not exhaustive.

Environmental

Social

Governance

01

Clean Energy Practices

Our Goal: To be powered by 50% green energy by 2028

As the pressure on fossil fuels in the country is increasing, RKFL is striving to adopt energy conservation methods to protect natural resources while remaining competitive.

Based on our discussion with a technology partner and initial assessment, we have decided to install an 8MW solar power plant in Jamshedpur.

Vendor evaluation process and discussion on technical parameters is currently being conducted.

02

Energy Optimisation

Our Goal: To be Carbon Neutral by 2050

At RKFL, we understand that our planet stands at the cusp of climate action to ensure that its effects do not become irreversible and catastrophic.

In an effort to develop a clear roadmap to improve our energy usage including transportation and distribution losses, we have decided to conduct a detailed energy audit by an independent third party .

Energy Audit is being conducted at our premises since January 2023. We expect to receive the audit report by February 2023.



Environmental

Social

Governance

03

Product Stewardship

EU has agreed provisionally on Carbon Border Adjustment Mechanism (CBAM) to establish carbon pricing policies with partner countries. It aims to promote opportunities in clean technology globally and provide a levelled competitive platform for local and foreign producers. Additional charges will be imposed on imports based on emission intensity of production processes.

With the aim to conform to these reporting standards and reduce our border tax liabilities, we will be conducting a Life Cycle Assessment for three of our products including front axle beam and crown wheel.

We are currently evaluating the product portfolio to finalize the third product for this assessment.

04

Waste & Water Management

Our Goal: Recycle 100% of our water use by 2025; Decrease 50% of our waste generation by 2030

We have completed the study to identify areas of improvement in waste & water management and have tagged the following recommendations –

Water Stewardship	Establishing zero liquid discharge/ water recycling techniques at our plant sites
Waste Management	Improvement in waste segregation techniques at source
Carbon Neutral Strategy	Installation of Continuous Emission Monitoring System (CEMS) at all plant sites

Our technical team is currently reviewing the approach to implement these recommendations



Environmental

Social

Governance

01

Empowering our community

Our Goal: Increase Employee Volunteering to 55% by 2030

We interact with the community through our engagement team to understand the needs of the community and respond in an effective manner. We have provided continuous support to our local community through the following initiatives -

Access to healthcare	Providing healthcare facilities to local community in Balicumba through our Medical Camp
Clean Cities	Sponsored installation and maintenance of 45 bins in Jamshedpur

02

Talent Development

Our Goal: Train 100% of our employees on ESG by 2023

Capacity building workshop for all our employees and value chain partners will enable our organization to develop competencies and skills that can make us more effective and sustainable. We aim to co-create solutions with our stakeholders by strengthening the ecosystem of our operations.

We will be conducting capacity building workshops on the evolving landscape of ESG regulations, trends and best practices. This will create awareness among all RKFL employees and build a robust structure to meet our ESG commitments.



Environmental

Social

Governance

01

Corporate Governance

Effective board structure and management are critical to being profitable and ensuring good governance across all levels. We have a ESG Working Committee to help integrate ESG across the organization.

Our Executive Director and CFO, Mr. Lalit Khetan is the sponsor for ESG at RKFL and thus ensures Board Oversight

RKFL has created a cross functional set of leaders to help deliver ESG initiatives and integrate them into our organization.

Hence today a cross function of leaders from Sales, HR, Company Secretary, Plant Operations, Marketing and Procurement are part of the ESG working committee.

Mr. Lalit Khetan oversees this Committee.

02

Policy Structure

Our Goal: Build effective policies and strengthen our outreach

In order to create transparency and increase accountability across all our stakeholders, we are revamping our existing company policies and reinforcing our professional quality standards.

New Policies	We have finalized our Human Rights Policy and Diversity, Equity & Inclusion Policy
Upcoming Policies	Customer Grievance Redressal Policy, Data Privacy and Cyber Security Policy, Stakeholder Engagement Policy to be introduced this year
Refreshing Policies	CSR Policy, Employee Code of Conduct and Supplier Quality Manual will be refreshed

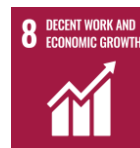

This presentation and the accompanying slides (the “Presentation”), which have been prepared by Ramkrishna Forgings Limited (the “Company”), have been prepared solely for information purposes and do not constitute any offer, recommendation or invitation to purchase or subscribe for any securities, and shall not form the basis or be relied on in connection with any contract or binding commitment whatsoever. No offering of securities of the Company will be made except by means of a statutory offering document containing detailed information about the Company.

This Presentation has been prepared by the Company based on information and data which the Company considers reliable, but the Company makes no representation or warranty, express or implied, whatsoever, and no reliance shall be placed on the truth, accuracy, completeness, fairness and reasonableness of the contents of this Presentation. This Presentation may not be all inclusive and may not contain all of the information that you may consider material. Any liability in respect of the contents of, or any omission from, this Presentation is expressly excluded.

Certain matters discussed in this Presentation may contain statements regarding the Company’s market opportunity and business prospects that are individually and collectively forward-looking statements. Such forward-looking statements are not guarantees of future performance and are subject to known and unknown risks, uncertainties and assumptions that are difficult to predict. These risks and uncertainties include, but are not limited to, the performance of the Indian economy and of the economies of various international markets, the performance of the industry in India and world-wide, competition, the Company’s ability to successfully implement its strategy, the Company's future levels of growth and expansion, technological implementation, changes and advancements, changes in revenue, income or cashflows, the Company's market preferences and its exposure to market risks, as well as other risks. The Company's actual results, levels of activity, performance or achievements could differ materially and adversely from results expressed in or implied by this Presentation. The Company assumes no obligation to update any forward-looking information contained in this Presentation. Any forward-looking statements and projections made by third parties included in this Presentation are not adopted by the Company and the Company is not responsible for such third-party statements and projections.

All Maps used in the Presentation are not to scale. All data, information and maps are provided "as is" without warranty or any representation of accuracy, timeliness or completeness.



COMPANY :



Ramkrishna Forgings Limited

CIN : L74210WB1981PLC034281

Mr. Lalit Kumar Khetan (Whole Time Director & CFO)

E: lalit.khetan@ramkrishnaforgings.com

www.ramkrishnaforgings.com

INVESTOR RELATIONS ADVISORS :



Orient Capital (a division of Link Group)

Mr. Nikunj Jain

+91 9769060608

nikunj.jain@linkintime.co.in

Mr. Amar Yardi

+91 7045121239

amar.yardi@linkintime.co.in