



**Jamna Auto Industries Ltd.**

May 24, 2024

To,  
BSE Limited  
Phiroze Jeejeebhoy Towers,  
Dalal Street, Mumbai- 400001  
Maharashtra

**BSE Code: 520051**

To,  
National Stock Exchange of India Limited  
Exchange Plaza, Plot no. C/1, G Block,  
Bandra-Kurla Complex, Bandra (E)  
Mumbai - 400051, Maharashtra

**NSE Code: JAMNAAUTO**

**Subject: Investors Presentation on the financial results for the quarter and year ended March 31, 2024.**

Dear Sir/Madam,

Pursuant to the requirements of Regulation 30 and Regulation 46 of SEBI (Listing Obligations & Disclosure Requirements) Regulations, 2015, we are enclosing herewith the presentation by the Company pertaining to the financial results for the quarter and year ended March 31, 2024.

Kindly take the above information on records

Thanking you,  
Yours Faithfully,  
**For Jamna Auto Industries Limited**

**Praveen Lakhera**  
**Company Secretary & Head-Legal**



# Jamna Auto Industries Limited

Investor Presentation

Q4 FY 23-24



This presentation and the accompanying slides (the “Presentation”), have been prepared by Jamna Auto Industries Limited (the “Company”), have been prepared solely for information purposes and do not constitute any offer, recommendation or invitation to purchase or subscribe for any securities, and shall not form the basis or be relied on in connection with any contract or binding commitment whatsoever. No offering of securities of the Company will be made except by means of a statutory offering document containing detailed information about the Company.

This Presentation has been prepared by the Company based on information and data which the Company considers reliable, but the Company makes no representation or warranty, express or implied, whatsoever, and no reliance shall be placed on, the truth, accuracy, completeness, fairness and reasonableness of the contents of this Presentation. This Presentation may not be all inclusive and may not contain all of the information that you may consider material. Any liability in respect of the contents of, or any omission from, this Presentation is expressly excluded.

Certain matters discussed in this Presentation may contain statements regarding the Company’s market opportunity and business prospects that are individually and collectively forward-looking statements. Such forward-looking statements are not guarantees of future performance and are subject to known and unknown risks, uncertainties and assumptions that are difficult to predict. These risks and uncertainties include, but are not limited to, the performance of the Indian economy and of the economies of various international markets, the performance of the industry in India and world-wide, competition, the company’s ability to successfully implement its strategy, the Company’s future levels of growth and expansion, technological implementation, changes and advancements, changes in revenue, income or cash flows, the Company’s market preferences and its exposure to market risks, as well as other risks. The Company’s actual results, levels of activity, performance or achievements could differ materially and adversely from results expressed in or implied by this Presentation. The Company assumes no obligation to update any forward-looking information contained in this Presentation. Any forward-looking statements and projections made by third parties included in this Presentation are not adopted by the Company and the Company is not responsible for such third party statements and projections.



Q4 FY 23-24  
Financial Updates

# Financial Trends - QoQ

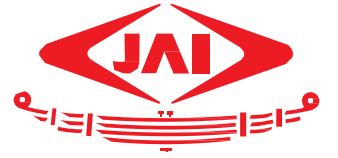

All figures are in INR crores

	Q4 FY 23-24	Q3 FY 23-24	Q4 FY 22-23
NET SALES	640	604	634
EBITDA	89/14.0%	87/14.5%	82/13.0%
PBT	78/12.2%	74/12.2%	71/11.2%
CASH ACCRUALS	65	67	63

Cash Accruals: PAT+ Depreciation

# Financial Trends - YoY



All figures are in INR crores

	FY 23-24	FY 22-23
NET SALES	2,427	2,325
EBITDA	331/13.7%	273/11.7%
PBT	283/11.7%	229/9.9%
CASH ACCRUALS	250	209

Cash Accruals: PAT+ Depreciation

# Profit & Loss Statement

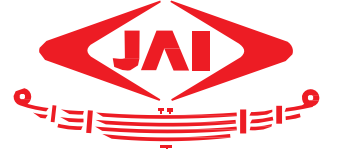

## Consolidated QoQ

All figures are in INR crores

Particulars	Q4 FY 23-24	Q4 FY 22-23	YoY	Q3 FY 23-24	QoQ
Net Sales	640	634	1%	604	6%
EBITDA	89	82	9%	87	2%
PBT	78	71	10%	74	6%
PAT	55	53	4%	55	0%

# Profit & Loss Statement



## Consolidated YoY

All figures are in INR crores

Particulars	FY 23-24	FY 22-23	YoY
Net Sales	2,427	2325	4%
EBITDA	331	273	21%
PBT	283	230	23%
PAT	205	168	22%



# Revenue Mix



## Product Mix

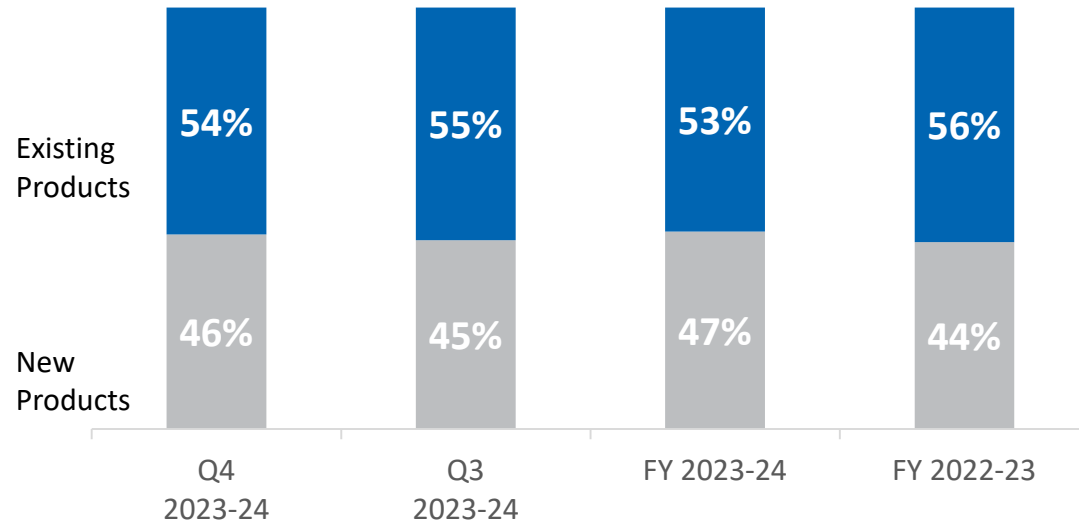

Lakshya Target: **50%** revenue from New Products by FY 2026-27

## Market Mix

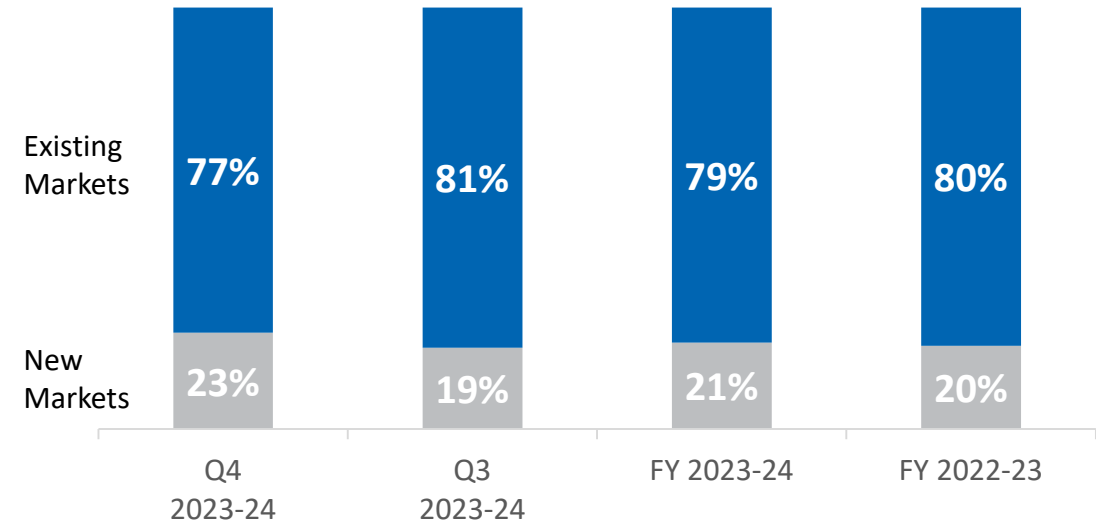

Lakshya Target: **50%** revenue from New Markets by FY 2026-27

# Update on New Developments



- The Company has entered into a MOU with VE Commercial Vehicles Limited for supply of leaf and parabolic springs and increase in the share of business.
- The Company is putting up a plant in Indore for leaf and parabolic springs.



# Industry Highlights

# Industry Highlights



All figures are in '000

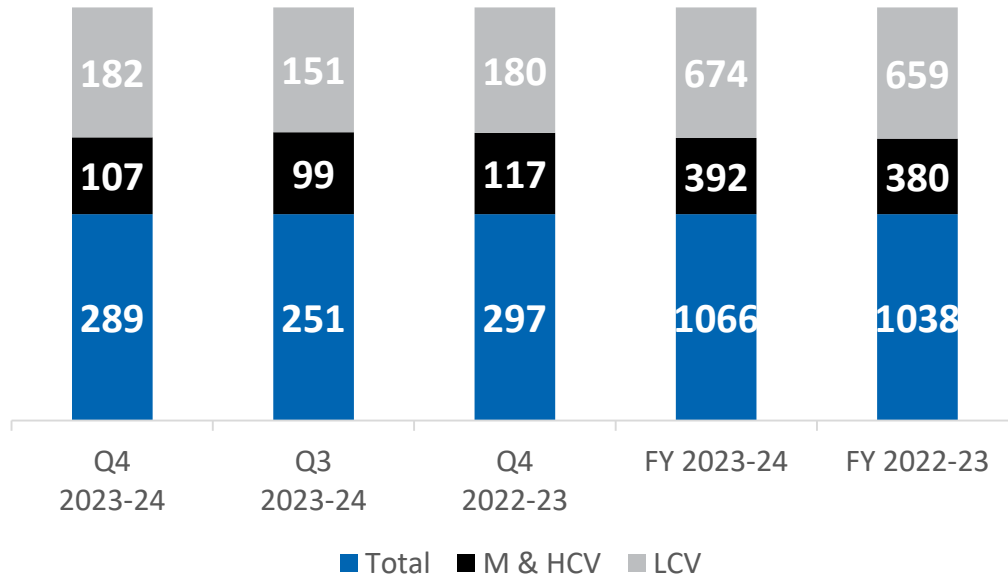

Data Source-SIAM

## LCV production changes

- ↑ - Q4 FY24 vs Q3 FY24 - 20% Increase
- ↑ - Q4 FY24 vs Q4 FY23 - 1% Increase
- ↑ - FY24 vs FY23 - 2% Increase

## M&HCV production changes

- ↑ - Q4 FY24 vs Q3 FY24 - 8% Increase
- ↓ - Q4 FY24 vs Q4 FY23 - 8% (Decrease)
- ↑ - FY24 vs FY23 - 3% Increase

For the Quarter

For Whole Year

QoQ Change %

YoY Change %

YoY Change %

20%

1%

2%

8%

-8%

3%

15%

-3%

3%



Company  
Overview

# JAI at a Glance



**Foundation**  
JAI is a renowned suspension manufacturer for commercial vehicles.

**World class Manufacturing Infrastructure**  
10 Manufacturing units including 1 In-house R&D center

- More than 16,000 touch points
- JAI Shoppe in Sanjay Gandhi Transport Nagar, Delhi which is one of the largest trucking center in India.

**Manufacturing**  
~300+ OEM parts  
~5,000+ AMI parts

**Sound Financials**  
CRISIL A1+/AA-

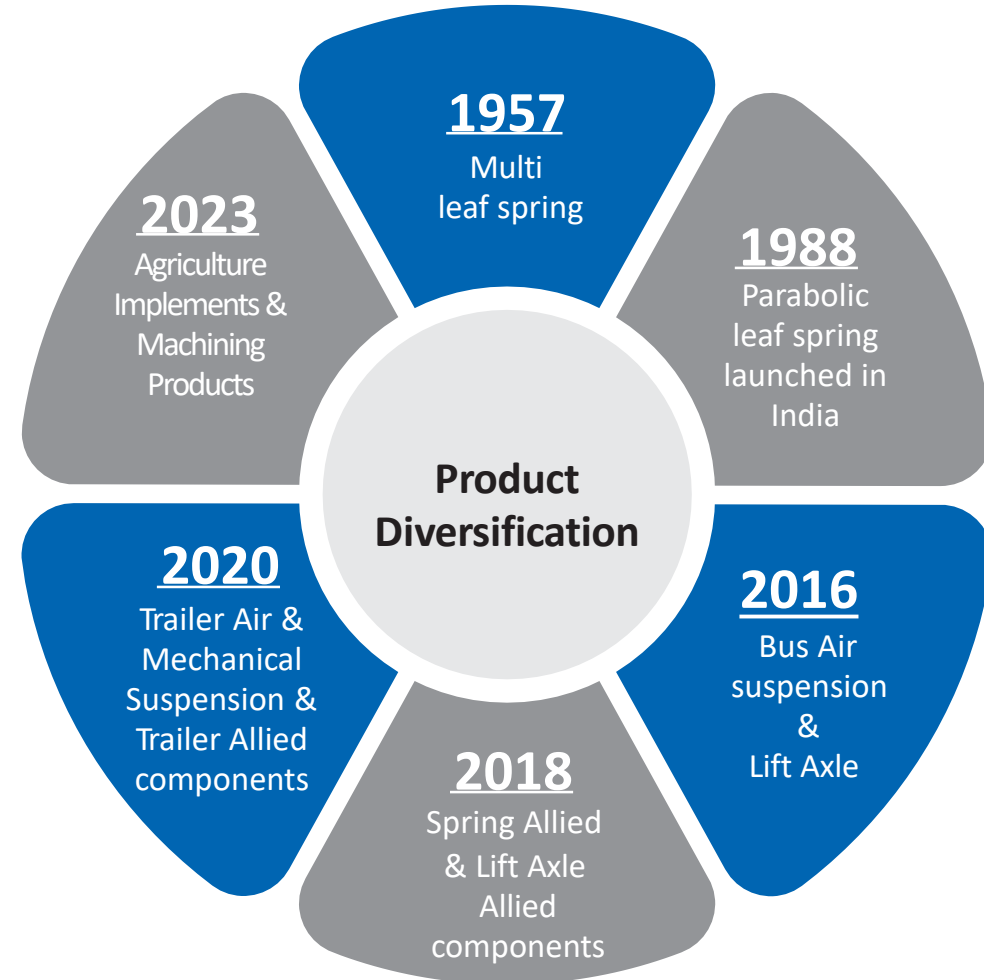

# Jai's Plants : Strategically Located Across OEM Plants

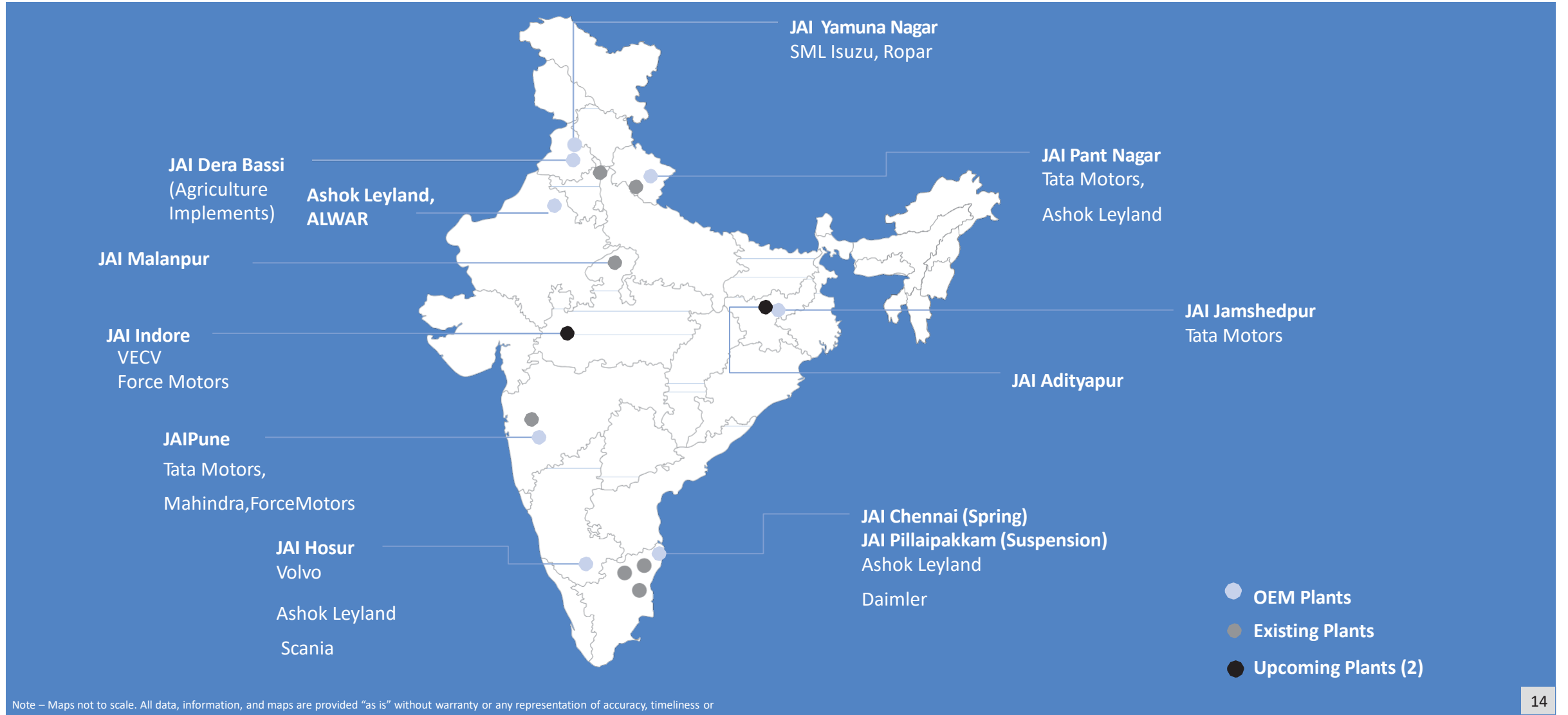

# Strength and Key Focus Areas

## Strength

- Manufacturing footprint with logistics benefit.
- Low BEP with Low Leveraged.
- Spare capacity to capture unprecedented demand from all Markets.
- Wide After Market Network  
300+ Distributors,  
11500+Retailers,  
15000+ Mechanics.



## Key Focus Areas

- New Markets ( AMI, AME).
- New Products ( Trailer, CPV in CV).



# JAI's OEM Customers



# JAI's Product Portfolio

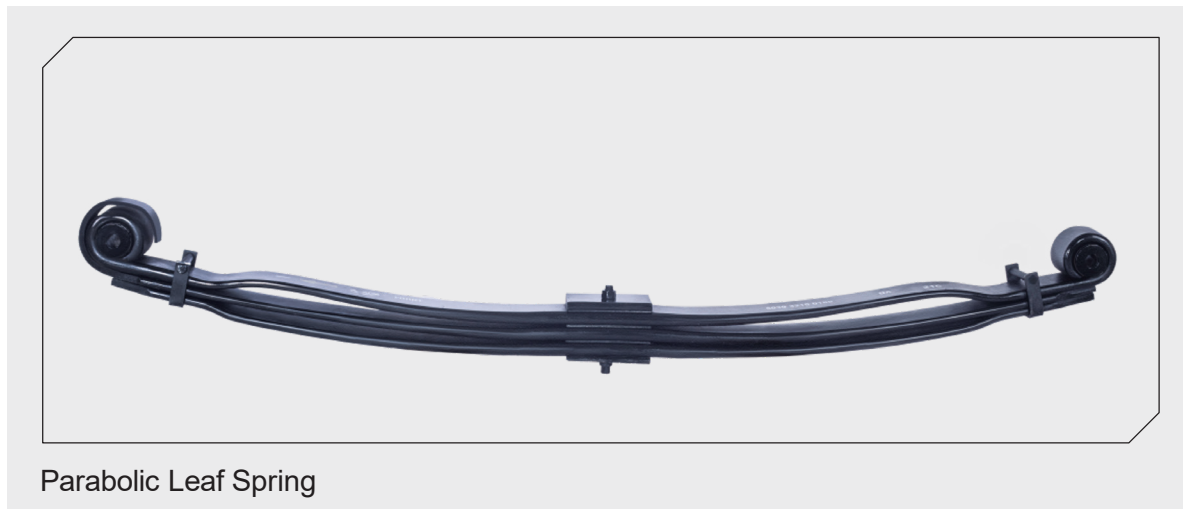
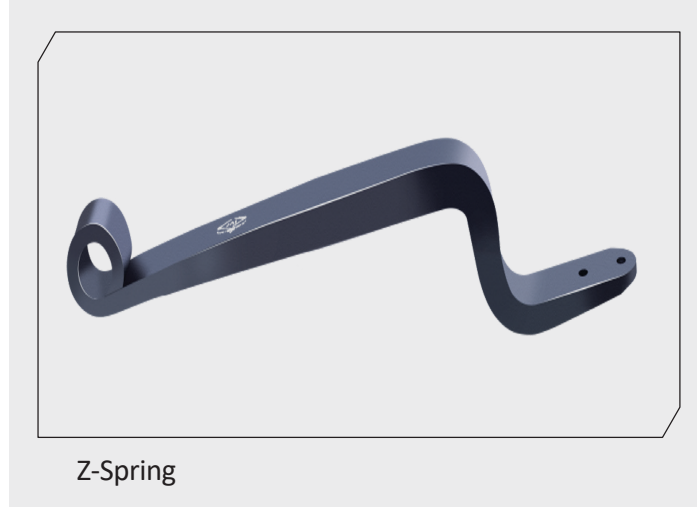

# JAI's Product Portfolio

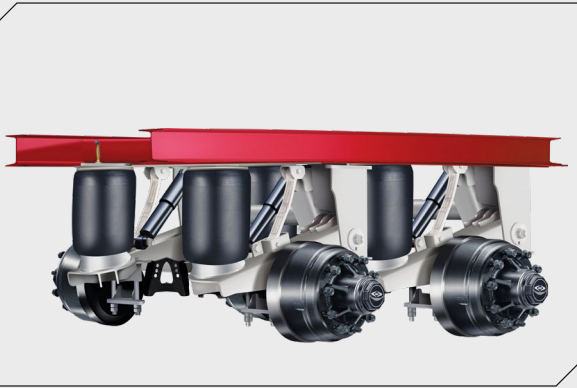

Bus Air Suspension

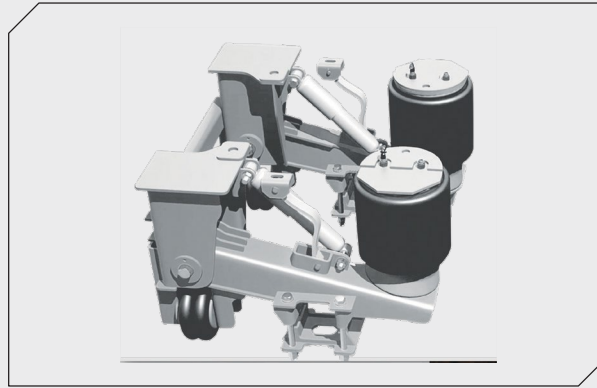

Trailer Air Suspension



Lift Axle

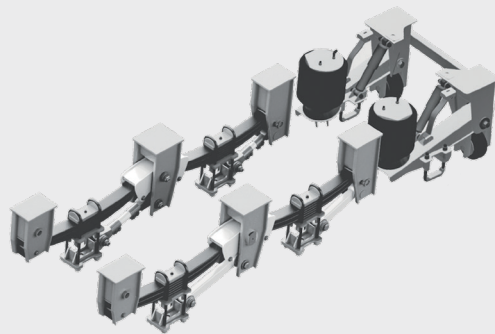

Trailer Mechanical and Air Suspension with Lift Axle

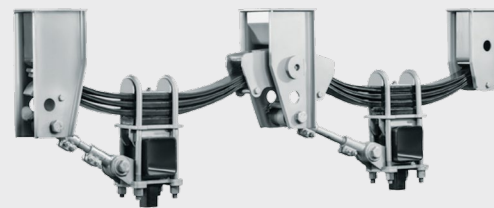

Trailer Mechanical Suspension

# JAI's Product Portfolio



## Agriculture Implements



Fertilizer Broadcaster



Fertilizer Broadcaster



Laser Land Leveller



Rotavator

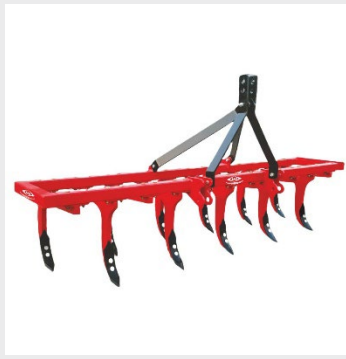

Cultivator

# After Market India JAI's Product Portfolio

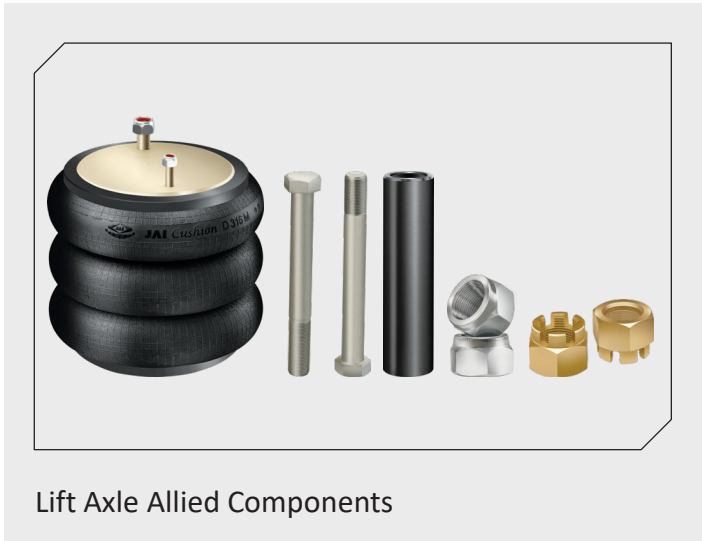

Lift Axle Allied Components

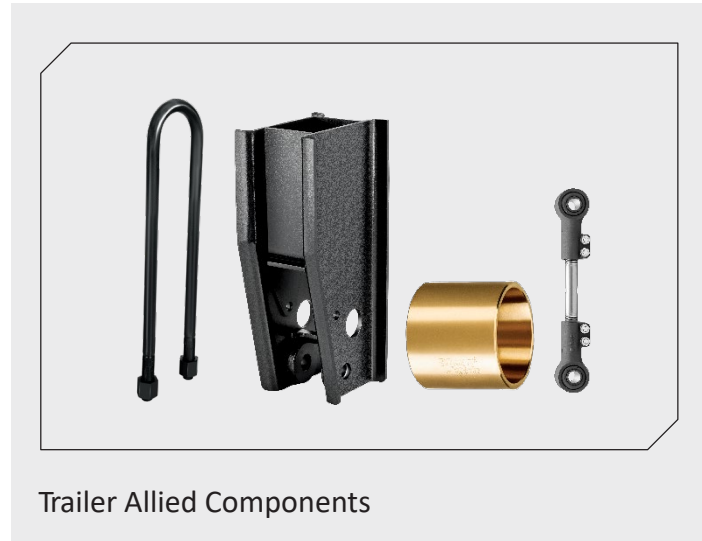

Trailer Allied Components

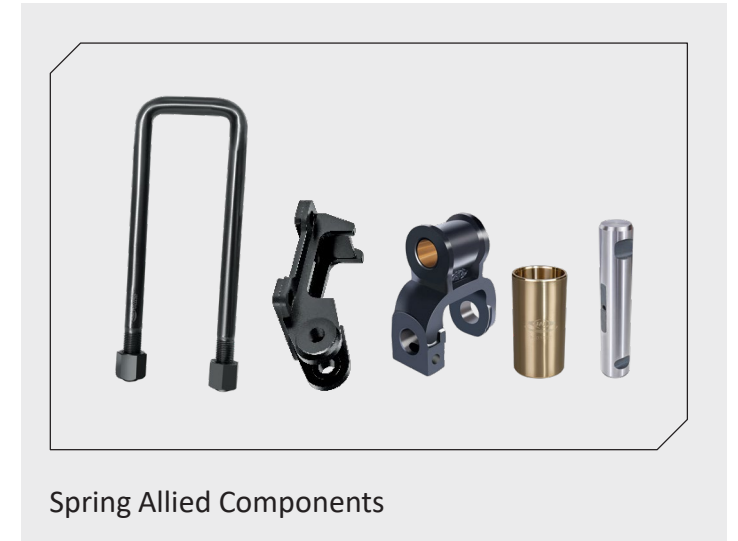

Spring Allied Components

# After Market India JAI's Product Portfolio



Brake lining

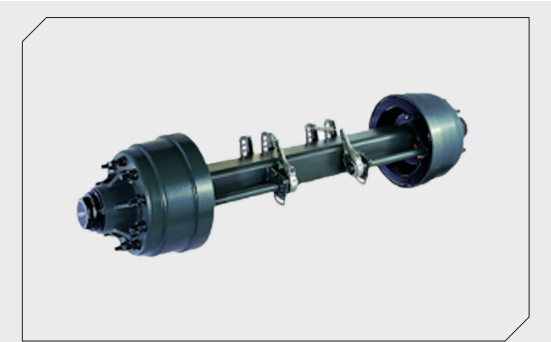

Trailer Axle



Water Pump



Clutch

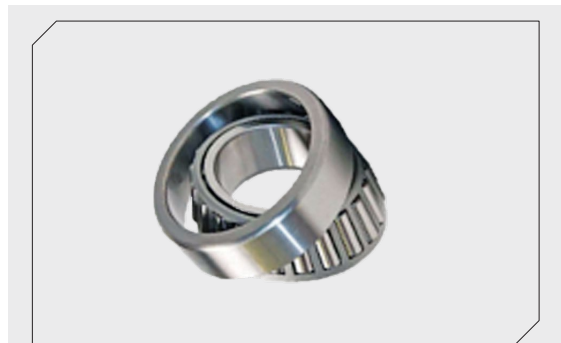

Bearing

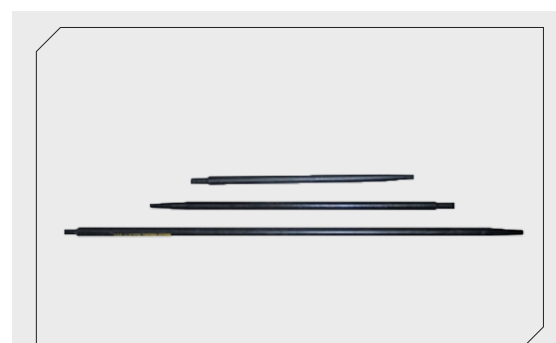

Jack Rod

**Most of the products above are only traded**

Jamna Auto Industries Limited ('JAI')

# JAI's Corporate Strategy: Lakshya 50XT

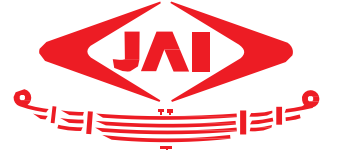

## Operational Goals

## Financial Goals

### Diversifying Products

### Diversifying Markets

### Maximizing Returns

### Value Creation

TARGETS  
for FY'27

50%

Revenue from  
New Products

50%

Revenue from  
New Market

50%

ROCE

50%

Dividend  
Payout

UPDATE  
for FY'24

47%

Revenue from  
New Products

21%

Revenue from  
New Market

31%

ROCE

46.6%

Dividend\*  
Payout

\*34%- Net of Bill Discounting

# Shareholding Pattern as on 31<sup>st</sup> March 2024

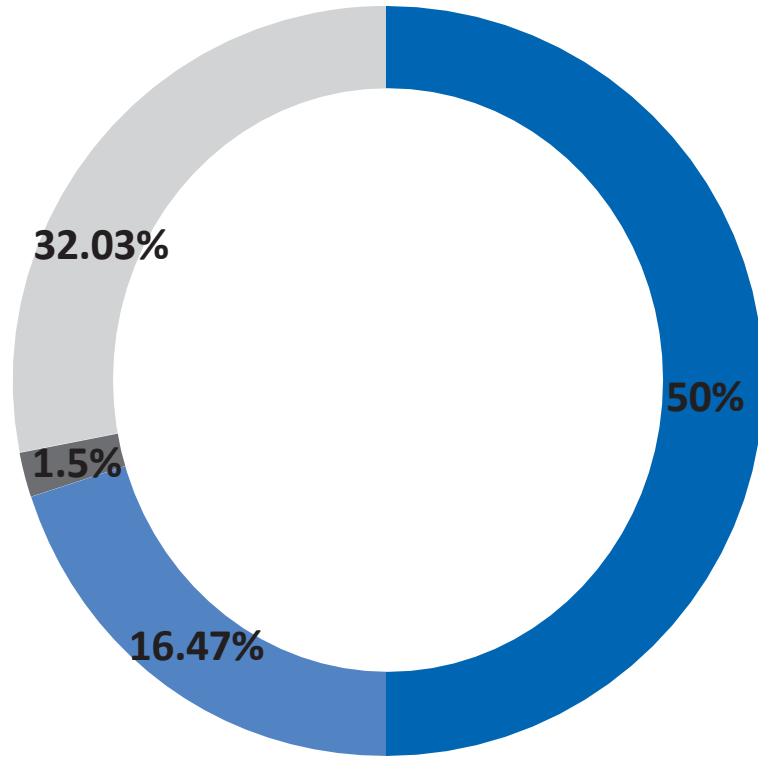

- Promoters
- Institutional investors

Categories	% Holding as on 31.3.2024	% Holding as on 31.3.2023
Promoters	50%	50%
Institutional Investors	14.81 %	19.9%
Bodies Corporate	1.75%	1.5%
Individual & Others	33.44%	28.6%
Total	100%	100%



# Contributing to the Society



We are committed to contribute to the social and economic welfare of communities in which we operate. Playing an active role in sustaining positive change within society, we aim to create opportunities for the holistic development of people from all sections of society.



Planted saplings by Mrs. Roopa Saini Former Captain, Indian Women Hockey Team in YNR.



Celebrated International Women's Day all locations by empowering women.



Our sponsored bodybuilder Mr. Sailesh won 4<sup>th</sup> position in 14<sup>th</sup> Mr. Junior India.-2024



Gifted 11 E-rickshaw to needy and trained women in Haryana to start income generation activity in their cities.



# Contributing to the Society



## Environment

- Constructed a vermi compost pit in Govt. polytechnic hathnikund-YNR
- Installed 20 heavy duty dustbins, in playways-YNR and in govt. school sriperumbadur-pillaipakkam.
- Planted 370 saplings across plant locations.
- Produced 1200 kgs of vermi compost from vermi compost pits JSR & YNR.
- On World Forest Day, sessions and drawing competitions were organized in all adopted government schools in YNR. These activities aimed to sensitize more than 400 students about the importance of forests and environmental conservation.
- Organized a poster competition for the student in all adopted Govt. school and in all sewing centers on Occasion of World Water Day. These activities aimed to sensitize approximately 2000 students and trainees about the importance of water conservation and management.
- Distributed 11 E-rickshaw to BPL Families ladies after driving training for earn their livelihood.



## Education

- Awarded JAI Annual scholarship to 267 meritorious students of GNKC and 218 students of GNKITM.
- 6 Anganwadi centers in Yamuna Nagar have been transformed into play schools through the renovation of buildings and fullfill all requirements requested by DC Office YNR.
- Renovated stages, constructed rooms and surrounded wall, repairing of roof and floor and installed 8 water coolers in Govt. Schools –YNR and JSR.
- Distributed dental kit amongst 2100 school students & sensitized on dental hygiene in JSR, Pant Nagar & YNR.
- Total 309 females got certificates in sewing course from Jamna Sewing Training Centers and 46 females got certificates in beauty culture therapy from Jamna Beautician Training center in YNR.
- Distributed 178 sewing machines passed out needy women to start their own business in YNR.
- Provided a multi-food processing machine & 02 days training including juice/gel/soap/shampoo making training to 40 inmates in District Prison, Panipat.
- Developed 3 Mini Science lab with technical partner stem learning in Govt. schools of YNR & JSR.



## Sports

- Awarded Annual Sponsorship to 51 sportspersons in GNK College in Yamuna Nagar along with 8 members got the cash rewards of Rs. 11,000/- for their achievements.
- Ensured monthly diet money to 11 sportspersons in GNK College in Yamuna Nagar.
- Sponsored a national level bodybuilder Mr. Shailesh Kumar for next one year for his diet and training in JSR.
- Supported for training to 4 sportsperson of Abhinav Bindra Foundation for one year Project.
- Installed open Gym in Tezli stadium, Chachrauli for help the Athletes in their warm-up and fitness..
- Installed Open Gyms in District prison YNR, Panipat and Gurugram to ensure good health & fitness among inmates & staff member.
- Installed Open gym with swings in 10 Govt. schools of Yamuna Nagar.



## Community Reach

- 05 Community Multi-speciality health check-up camps were organized, covering 835 community members in YNR and JSR and distributed required medicines.
- Under the Project "Open Defecation Free Yamuna Nagar" constructed more 26 individual toilets for BPL/EWS families in Chikan.
- Distributed monthly pension to 142 Sr. citizen, widow and PWD's in Faizpur, Kalesar, Tazewala, Mandoli and Dussani village.
- Supported Balkunj child care home-Chachrauli for their monthly food requirements for 80 children on each month.
- Construct a shed, Dump soils, Installed water Tank in the cremation ground of faizpur, Arriyanwala & Kishanpura in YNR.
- Distributed 250 Nutrition kit to anemic girls and pregnant ladies in YNR & Chennai on monthly basis for 6 Months.
- Arranged lunch on every month for 400 migrant people in Yamuna Nagar under food for all program.
- Installed 130 benches in villages and govt. schools in YNR & Pune and also installed 50 street lights in villages of YNR.
- Celebrate International Women's Day across all the locations and Sensitized over 2500 people on the Social issues facing by Women's in the society.





**Thank You**

---