



## PPAP Automotive Limited

B-206A ■ Sector-81 ■ Phase-II ■ Noida 201305 ■ Uttar Pradesh ■ India  
☎ +91-120-4093901 ✉ info@ppapco.com 🌐 www.ppapco.in

10<sup>th</sup> August, 2022

The Listing Department  
BSE Limited  
Phiroze Jeejeebhoy Towers,  
Dalal Street,  
Mumbai - 400001  
Symbol: 532934

The Listing Department  
The National Stock Exchange of India Limited  
Exchange Plaza,  
Bandra Kurla Complex,  
Bandra (E), Mumbai - 400051  
Symbol: PPAP

**Subject: Analysts and Investors Presentation pursuant to Regulation 30 of the Securities and Exchange Board of India (Listing Obligations and Disclosure Requirements) Regulations, 2015.**

Dear Sir,

Pursuant to Regulation 30 of the Securities and Exchange Board of India (Listing Obligations and Disclosure Requirements) Regulations, 2015, please find enclosed the Analysts and Investors presentation on the financial results (standalone and consolidated) of the Company for the quarter ended 30<sup>th</sup> June, 2022.

This is for your information and record.

Thanking you,

Yours faithfully,  
For **PPAP Automotive Limited**

**Pankhuri Agarwal**  
**Company Secretary & Compliance Officer**



# PPAP Automotive Limited

*TAKING CHALLENGES, TOGETHER*

Investor presentation – August 2022



# Safe Harbour



This presentation and the accompanying slides (the “Presentation”), which have been prepared by **PPAP Automotive Limited (the “Company”)**, have been prepared solely for information purposes and do not constitute any offer, recommendation or invitation to purchase or subscribe for any securities, and shall not form the basis or be relied on in connection with any contract or binding commitment whatsoever. No offering of securities of the Company will be made except by means of a statutory offering document containing detailed information about the Company.

This Presentation has been prepared by the Company based on information and data which the Company considers reliable, but the Company makes no representation or warranty, express or implied, whatsoever, and no reliance shall be placed on, the truth, accuracy, completeness, fairness and reasonableness of the contents of this Presentation. This Presentation may not be all inclusive and may not contain all of the information that you may consider material. Any liability in respect of the contents of, or any omission from, this Presentation is expressly excluded.

This presentation contains certain forward-looking statements concerning the Company’s future business prospects and business profitability, which are subject to a number of risks and uncertainties and the actual results could materially differ from those in such forward looking statements. The risks and uncertainties relating to these statements include, but are not limited to, risks and uncertainties regarding fluctuations in earnings, our ability to manage growth, competition (both domestic and international), economic growth in India and abroad, ability to attract and retain highly skilled professionals, time and cost over runs on contracts, our ability to manage our international operations, government policies and actions regulations, interest and other fiscal costs generally prevailing in the economy. The Company does not undertake to make any announcement in case any of these forward looking statements become materially incorrect in future or update any forward-looking statements made from time to time by or on behalf of the Company.



# Financial Highlights



# Key Highlights



## Q1FY23 Performance

- Revenue grew by 47.8% to Rs 116.3 crores in Q1FY23 on a Y-o-Y basis on account of increase in demand post covid normalization
- The Company clocked higher sales during Q1FY23 and improved capacity utilization which has resulted into an EBITDA growth of 255.5% to Rs 12.5 crores in Q1FY23
- For the quarter, the Parts contributed 93% of the total revenues while Tools & Others contributed 7% of the revenues
- The capacity utilization for the full year stood at 72%
- During the quarter, PPAP had begun supplying parts to newly launched vehicles of marquee OEMs such as:
  - Maruti Suzuki's **Brezza**
  - Honda's **Honda City Hybrid**
- The Company has received "Delivery" award from Toyota and awarded for 'Timely Delivery' from Somemiya Corporation.
- PPAP stood as a runner-up in 'National Quality' Circle competition for Honda

# Management Commentary



**Commenting on the results and performance for Q1 FY23, Mr. Ajay Kumar Jain, Chairman & MD of PPAP Automotive Ltd said:**

*“The strong upswing in demand for passenger vehicles is continuing. The industry is showing promising growth and is poised to achieve highest ever volumes in the current year. The multiple challenges facing the industry are slowly and steadily getting resolved and every day the sun is shining brighter on the industry. The semiconductor shortage is easing out. The unprecedented and sudden rise of commodity prices is also steadily losing steam.*

*The group continues to grow strong in its core business areas as well as in all the new initiatives which were launched in the past two years. Our focus on developing components for Electric Vehicles for passenger cars as well as Two Wheelers continue to drive up our sales. The focus on aftermarket also continues to yield value. The group continues to establish its foothold in these uncharted territories to create opportunities for itself.*

*Due to this revamped focus, the consolidated operating income grew by 56.4% and EBITDA has shown growth of 330%, with margins stood at 10.5%. The group continues to deliver robust performance despite multiple headwinds and promises to grow from strength to strength in the upcoming years”*



# Key Highlights



Quarterly  
Performance

Revenue

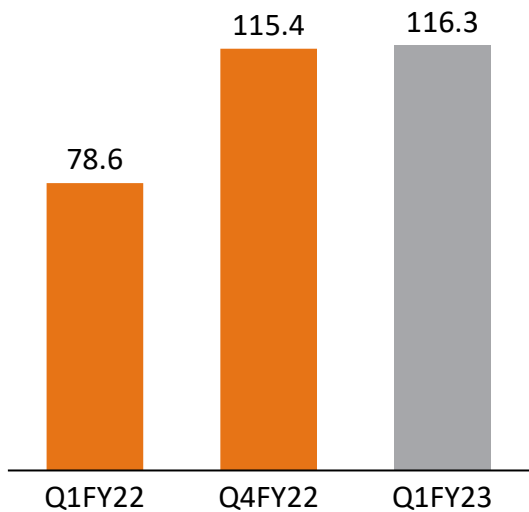

EBITDA

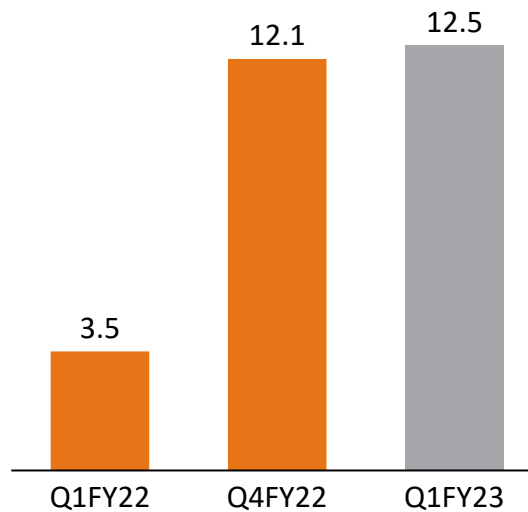

PAT  
INR Cr

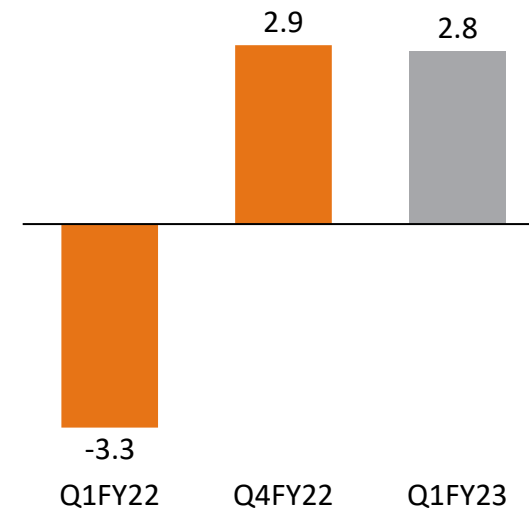



# Segmental Breakup



**Q1FY22**

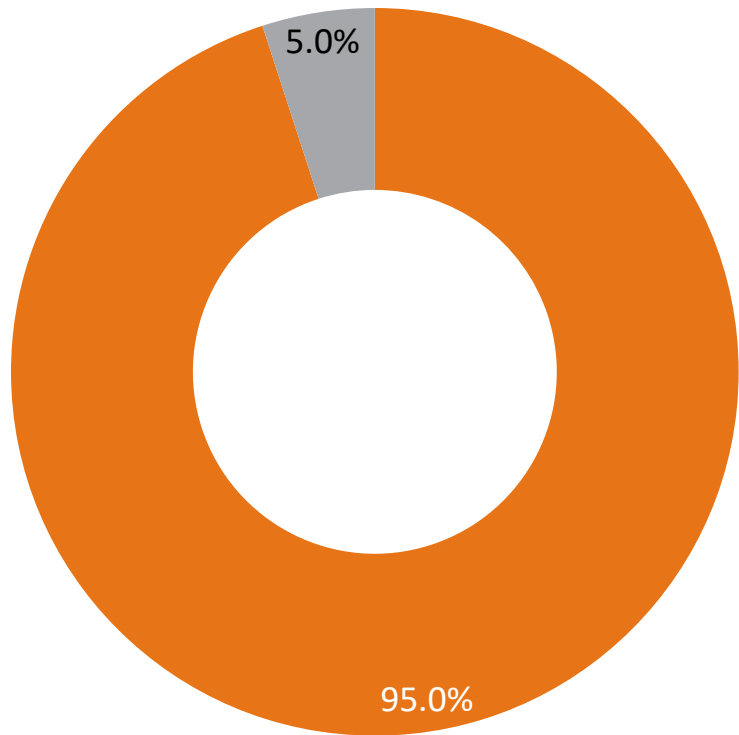

**Q1FY23**

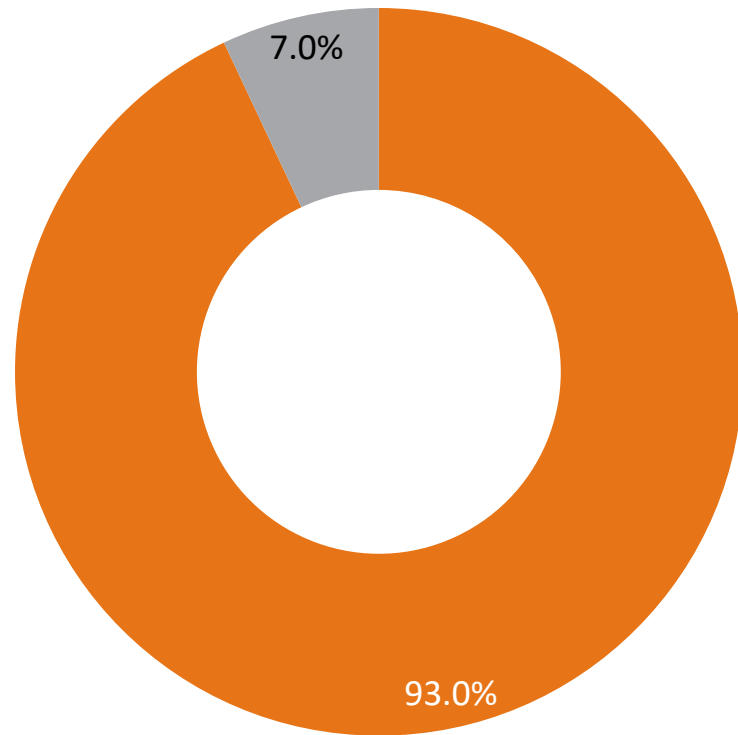

Parts Tools & Others



# Standalone P&L – Q1 FY23



| Particulars (INR Cr)           | Q1 FY23      | Q1 FY22      | Y-o-Y (%)     | Q4 FY22      | Q-o-Q (%)    | FY22         |
|--------------------------------|--------------|--------------|---------------|--------------|--------------|--------------|
| <b>Revenue from operations</b> | <b>116.3</b> | <b>78.6</b>  | <b>47.8%</b>  | <b>115.4</b> | <b>0.8%</b>  | <b>409.1</b> |
| COGS                           | 70.3         | 46.6         |               | 70.0         |              | 247.1        |
| <b>Gross Profit</b>            | <b>46.0</b>  | <b>32.0</b>  | <b>43.4%</b>  | <b>45.4</b>  | <b>1.3%</b>  | 162.0        |
| <b>Gross Profit Margin</b>     | <b>39.5%</b> | <b>40.7%</b> |               | <b>39.3%</b> |              | <b>39.6%</b> |
| Employee Expenses              | 18.4         | 17.1         |               | 17.7         |              | 69.6         |
| Other Expenses                 | 15.1         | 11.4         |               | 15.6         |              | 53.3         |
| <b>EBITDA</b>                  | <b>12.5</b>  | <b>3.5</b>   | <b>255.5%</b> | <b>12.1</b>  | <b>3.3%</b>  | <b>39.1</b>  |
| <b>EBITDA Margin</b>           | <b>10.7%</b> | <b>4.5%</b>  |               | <b>10.5%</b> |              | <b>9.5%</b>  |
| Other Income                   | 0.7          | 0.3          |               | 0.7          |              | 2.0          |
| Depreciation                   | 7.2          | 7.1          |               | 7.1          |              | 29.0         |
| Finance Cost                   | 2.2          | 1.1          |               | 1.8          |              | 6.0          |
| <b>Profit before Tax</b>       | <b>3.8</b>   | <b>-4.4</b>  |               | <b>3.9</b>   |              | <b>6.1</b>   |
| Tax expenses                   | 1.0          | -1.1         |               | 1.0          |              | 1.5          |
| <b>Profit for the year</b>     | <b>2.8</b>   | <b>-3.3</b>  | <b>-</b>      | <b>2.9</b>   | <b>-2.1%</b> | <b>4.6</b>   |
| <b>PAT Margins</b>             | <b>2.4%</b>  | <b>-4.2%</b> |               | <b>2.5%</b>  |              | <b>1.1%</b>  |
| EPS                            | 2.03         | -2.37        |               | 2.08         |              | 3.28         |

# Consolidated P&L – Q1 FY23



| Particulars (INR Cr)           | Q1 FY23      | Q1 FY22      | Y-o-Y (%)     | Q4 FY22      | Q-o-Q (%)   | FY22         |
|--------------------------------|--------------|--------------|---------------|--------------|-------------|--------------|
| <b>Revenue from operations</b> | <b>123.2</b> | <b>78.8</b>  | <b>56.5%</b>  | <b>122.6</b> | <b>0.5%</b> | <b>421.9</b> |
| COGS                           | 75.0         | 46.5         |               | 75.5         |             | 255.8        |
| <b>Gross Profit</b>            | <b>48.2</b>  | <b>32.2</b>  | <b>49.5%</b>  | <b>47.1</b>  | <b>2.4%</b> | <b>166.1</b> |
| <b>Gross Profit Margin</b>     | <b>39.1%</b> | <b>40.9%</b> |               | <b>38.4%</b> |             | <b>39.4%</b> |
| Employee Expenses              | 19.3         | 17.6         |               | 18.8         |             | 72.2         |
| Other Expenses                 | 15.9         | 11.6         |               | 16.2         |             | 55.2         |
| <b>EBITDA</b>                  | <b>13.0</b>  | <b>2.5</b>   | <b>330.3%</b> | <b>12.1</b>  | <b>7.0%</b> | <b>38.6</b>  |
| <b>EBITDA Margin</b>           | <b>10.6%</b> | <b>3.8%</b>  |               | <b>9.9%</b>  |             | <b>9.1%</b>  |
| Other Income                   | 0.5          | 0.2          |               | 0.3          |             | 1.0          |
| Depreciation                   | 7.6          | 7.2          |               | 7.3          |             | 29.5         |
| Finance Cost                   | 2.5          | 1.2          |               | 2.0          |             | 6.5          |
| <b>Profit before Tax</b>       | <b>1.4</b>   | <b>-5.7</b>  |               | <b>1.7</b>   |             | <b>0.1</b>   |
| Tax expenses                   | 0.9          | -1.3         |               | 0.8          |             | 0.9          |
| <b>Profit for the year</b>     | <b>0.6</b>   | <b>-4.5</b>  | <b>-</b>      | <b>0.9</b>   | <b>-</b>    | <b>-0.8</b>  |
| <b>PAT Margins</b>             | <b>0.5%</b>  | <b>-5.7%</b> |               | <b>0.7%</b>  |             | <b>-0.2%</b> |
| EPS                            | 0.42         | -3.18        |               | 0.61         |             | -0.56        |



# Company Overview

# Business – at a Glance



## Tool Business

- The Company established its tooling facility in 2008 for captive purpose
- In 2020, this facility has been commercialized as a profit center
- Plastic injection molds upto 1.5 m \* 1.0 m can be manufactured for Automotive, White Goods, Electrical Industry applications

**PTI**  
PPAP Tokai India Rubber Pvt Ltd

### Automotive Parts Business

- Core competence in developing Automotive Body Sealing systems and Interior and Exterior Injection molded parts
- Enhancing per car contribution by adding more products and customers in all segments (PV / 2 W / CV / Tier 1)
- PPAP is focused on development of value-added products through in house design and technology development capabilities
- Focusing on Electric Vehicles (all products are engine agnostic products)



## Aftermarket Business

- The Company has commenced with development of aftermarket parts and sales of automotive accessories through wholly owned subsidiary.
- Establishing additional distribution network for offline sales on pan India basis
- Established e-commerce network for online sales through own website and e-commerce portals



## EV Component Business

- The Company has forayed in manufacturing of EV components for Electric cycles, 2-Wheeler and 3-Wheeler Applications
- The production of Battery packs for Electric cycles, 2-Wheelers and 3-Wheelers have been commenced
- Focused on development of value-added products through in house design and technology development capabilities



## Pail Container Business

- The company has developed a product range of PAIL CONTAINERS
- The company has started supplies to agriculture sector and is now focusing on expanding its customer base to Paint and Lubrication industry
- Railways, Construction, Industrial Products need to be started

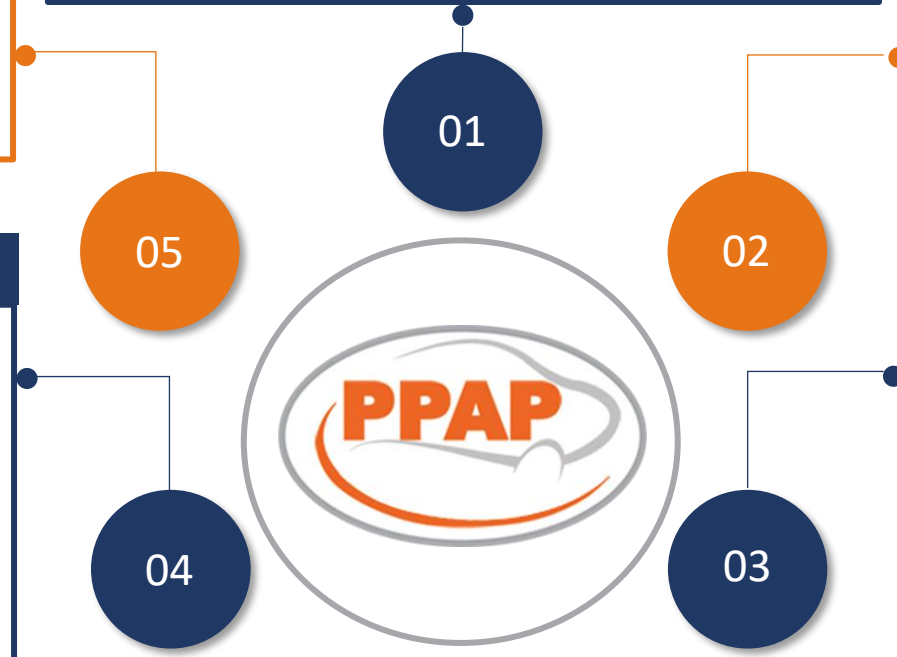

# Company Ethos



## Vision Statement

To be

our customer's

No. 1 supplier



## Mission Statement

To be a global level excellence company,  
with an inspiring work culture,  
for serving our customers and our society,  
by exceeding the expectations,  
of all our stakeholders



## Our Values

- Trustworthiness
- Mutual Respect
- Creativity
- Co-operation
- Excellence

# Journey Towards Excellence...

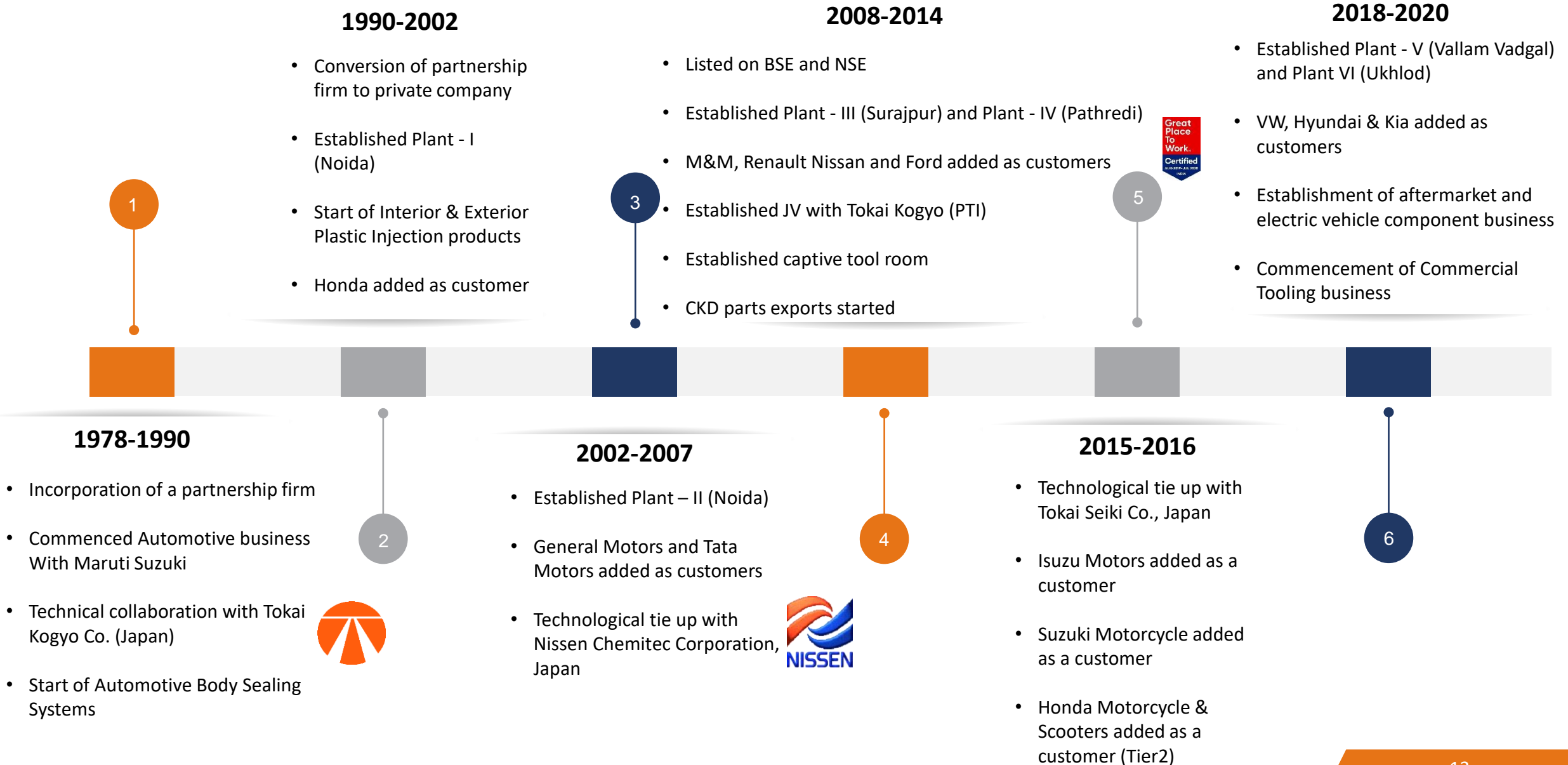



# Board of Directors



**Ajay Kumar Jain**  
Chairman &  
Managing Director

Bachelor of Commerce from Shri Ram College of Commerce, Delhi University

Associated with the Company since inception with experience of over 45 years in polymer processing industry and over 30 years in the automotive industry

President of Toyota Kirloskar Supplier Association



**Bhuwan Kumar Chaturvedi**  
Independent Director

B.E. (Mech.) from I.I.T. Roorkee and M.B.A. from IIM, Ahmedabad

Has a rich and diverse top management experience in the field of automobile, auto components, engineering, etc.

Associated with Tata Motors, Eicher and Hindustan Motors

President of Tractor Manufacturers Association & Member of CII National Council



**Pravin Kumar Gupta**  
Independent Director

A Fellow Member of the Institute of Chartered Accountants of India

Managing Partner of K.S. Gupta Co., Chartered Accountants (Est.: 1955) with over 35 years of experience.

He has in depth knowledge and experience in the field of Corporate Finance, Taxation, Accounts and Audit



**Celine George**  
Independent Director

PGDM in Business Economics from Delhi University, PGDIM from IMI Delhi and Chevening Gurukul Scholar from London School of political science & Economics

Associated with ONGC, TCS, Cairn Energy, Max healthcare

She has over 30 years of experience in the areas of Leadership, Business Transformation and HR



**Vinay Kumari Jain**  
Non-Executive Director

Bachelor of Science from Delhi University

Founding partner of our Company

Associated with the business since inception

Work experience of over three decades. She possess a deep understanding of automotive business



**Abhishek Jain**  
CEO & Managing Director

Bachelor of Science in Industrial Engineering from Purdue University, USA

Work experience of over 15 years

Chairman of North region Honda Suppliers Club

Coordinator Zone 2 Automotive Component Manufacturers Association Northern Region

# Operating Locations...

The Company's state of the art manufacturing facilities are strategically located across the PVs automotive hubs in Northern, Southern and Western India

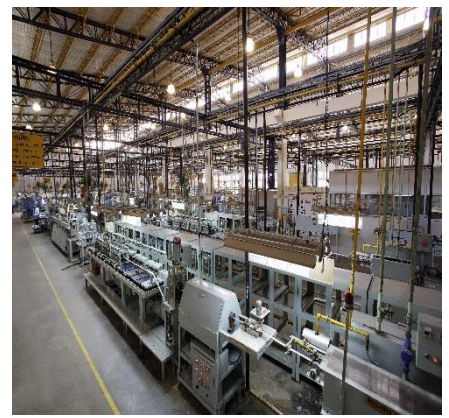
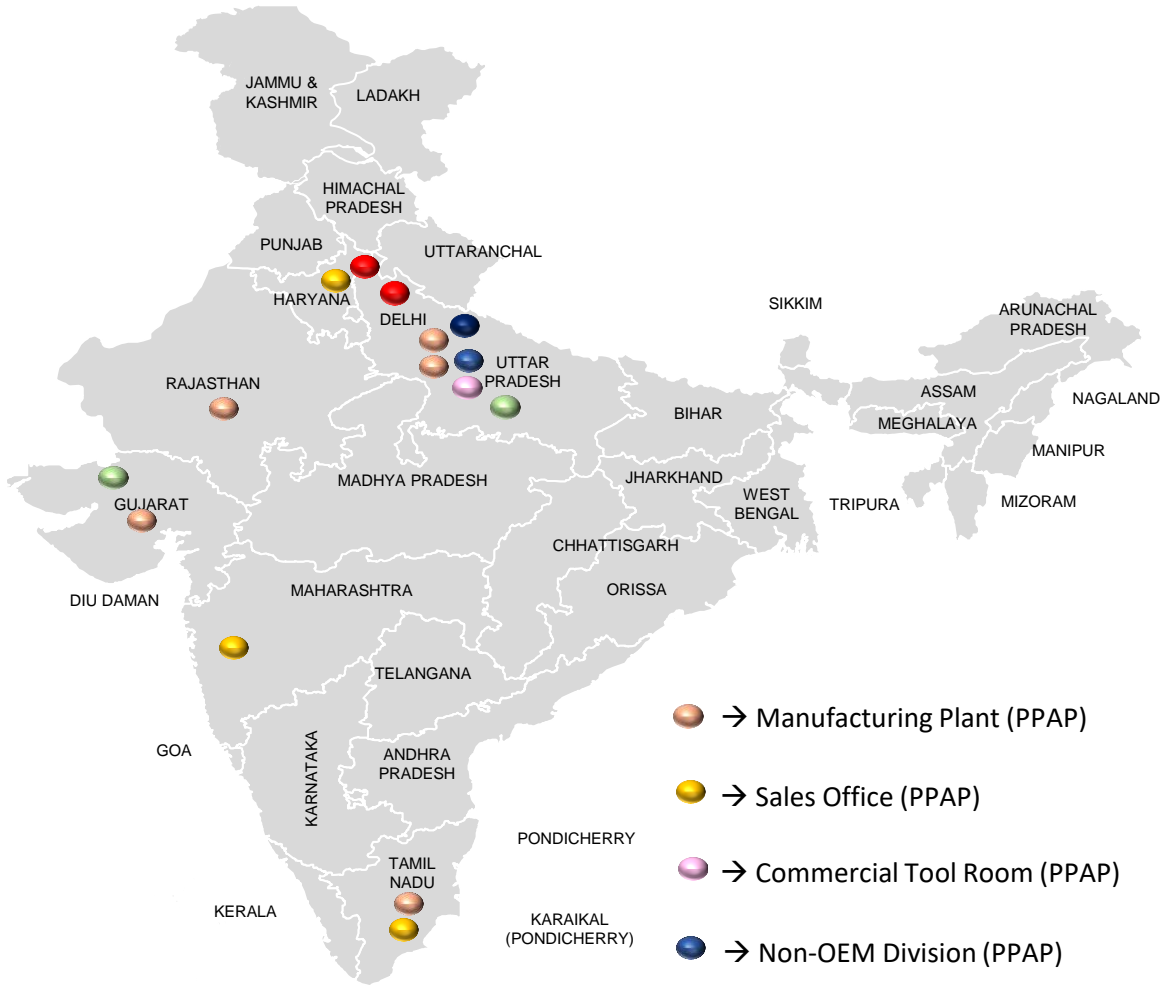

Note – Maps not to scale. All data, information, and maps are provided “as is” without warranty or any representation of accuracy, timeliness or completeness



# Manufacturing Facilities...

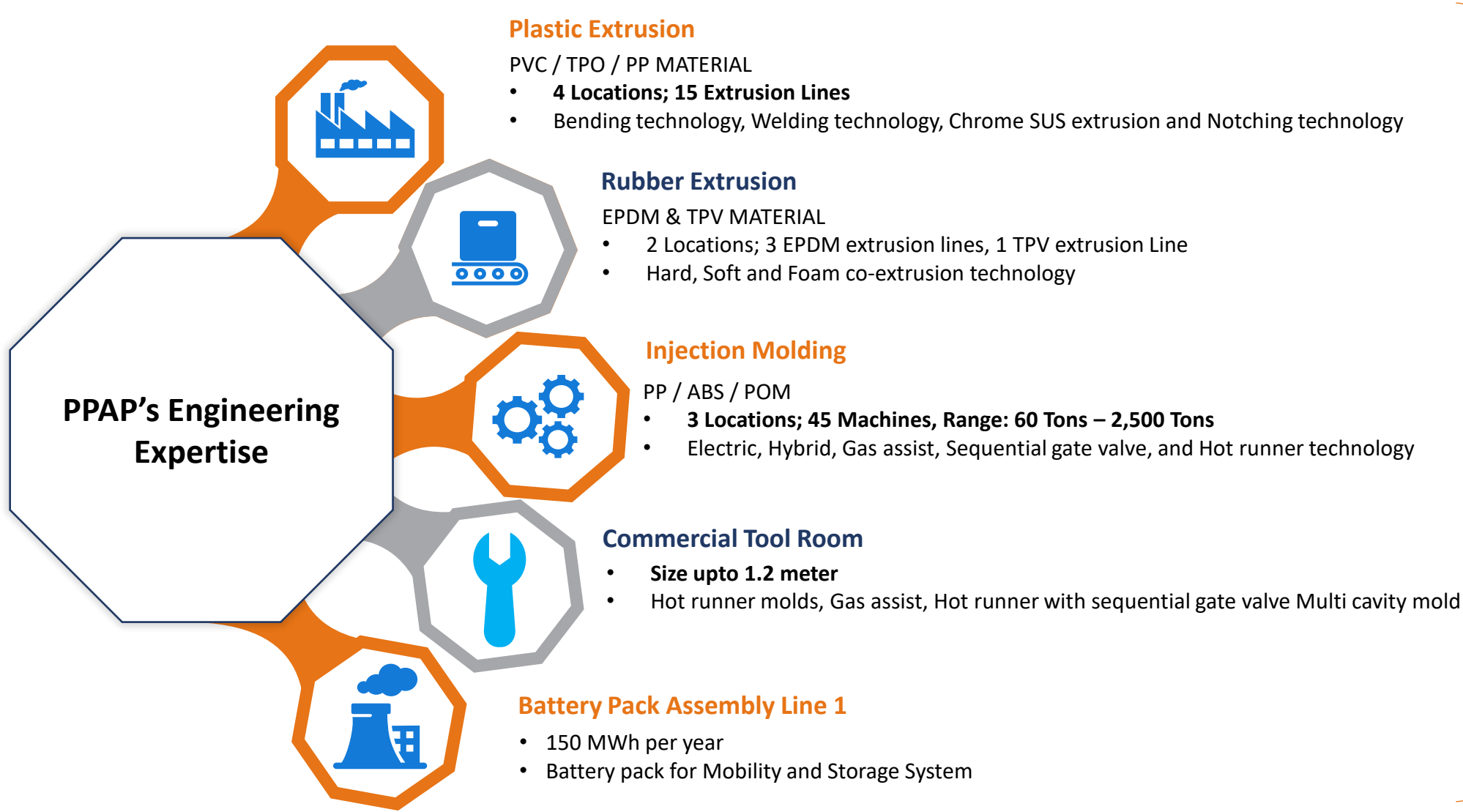

Part & Tool Design  
Manufacturing  
Tool  
Testing & Validation

# Passenger Vehicle Products

PPAP offers a diverse range of products that are applicable to both EV and non-EV vehicles

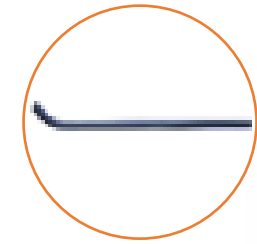
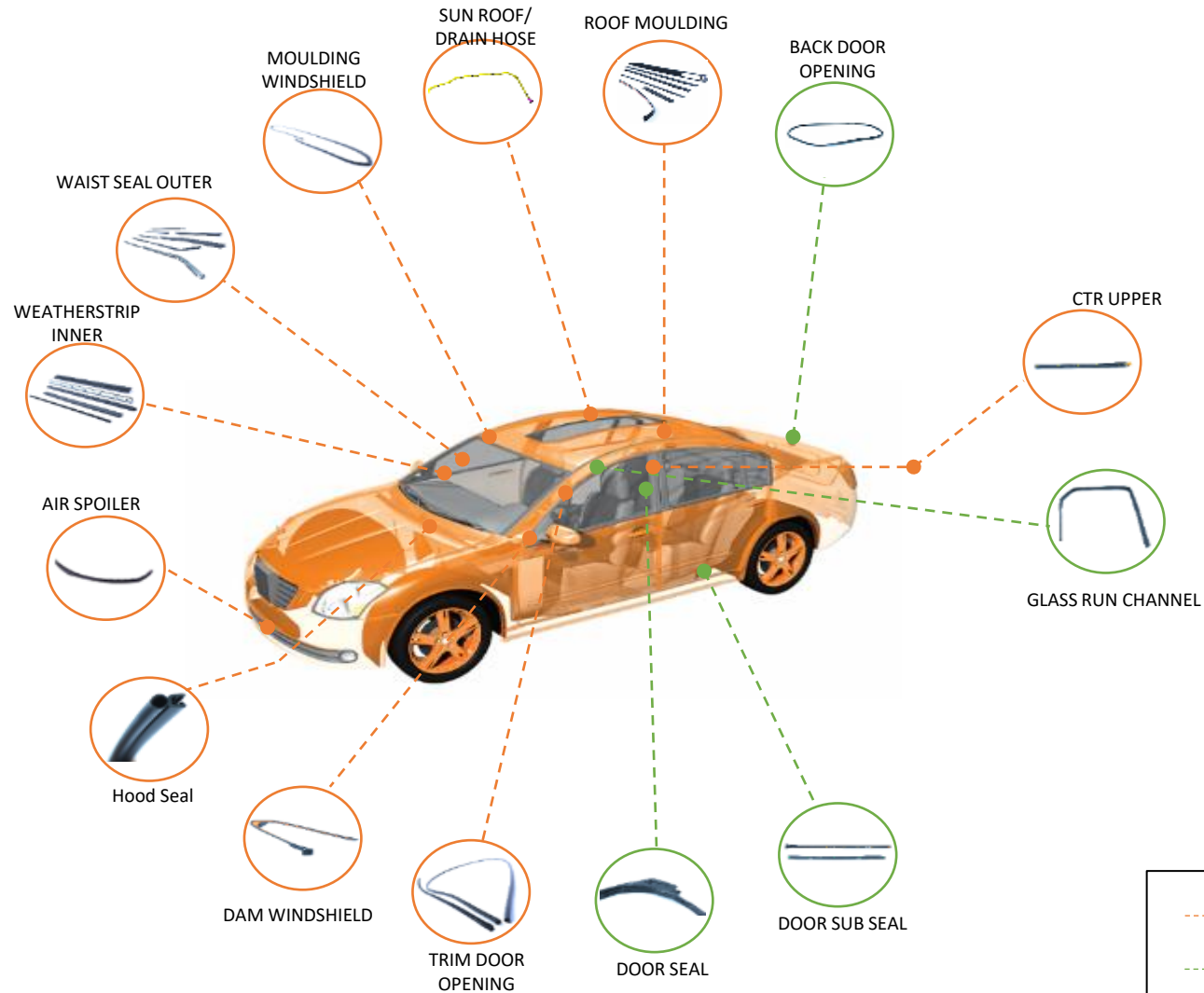

SLIDE RAIL



- - - - - ● Plastic Extrusion  
- - - - - ● Rubber Extrusion

PPAP Tokai India Rubber Pvt Ltd

# Passenger Vehicle Products

PPAP offers a diverse range of products that are applicable to both EV and non-EV vehicles

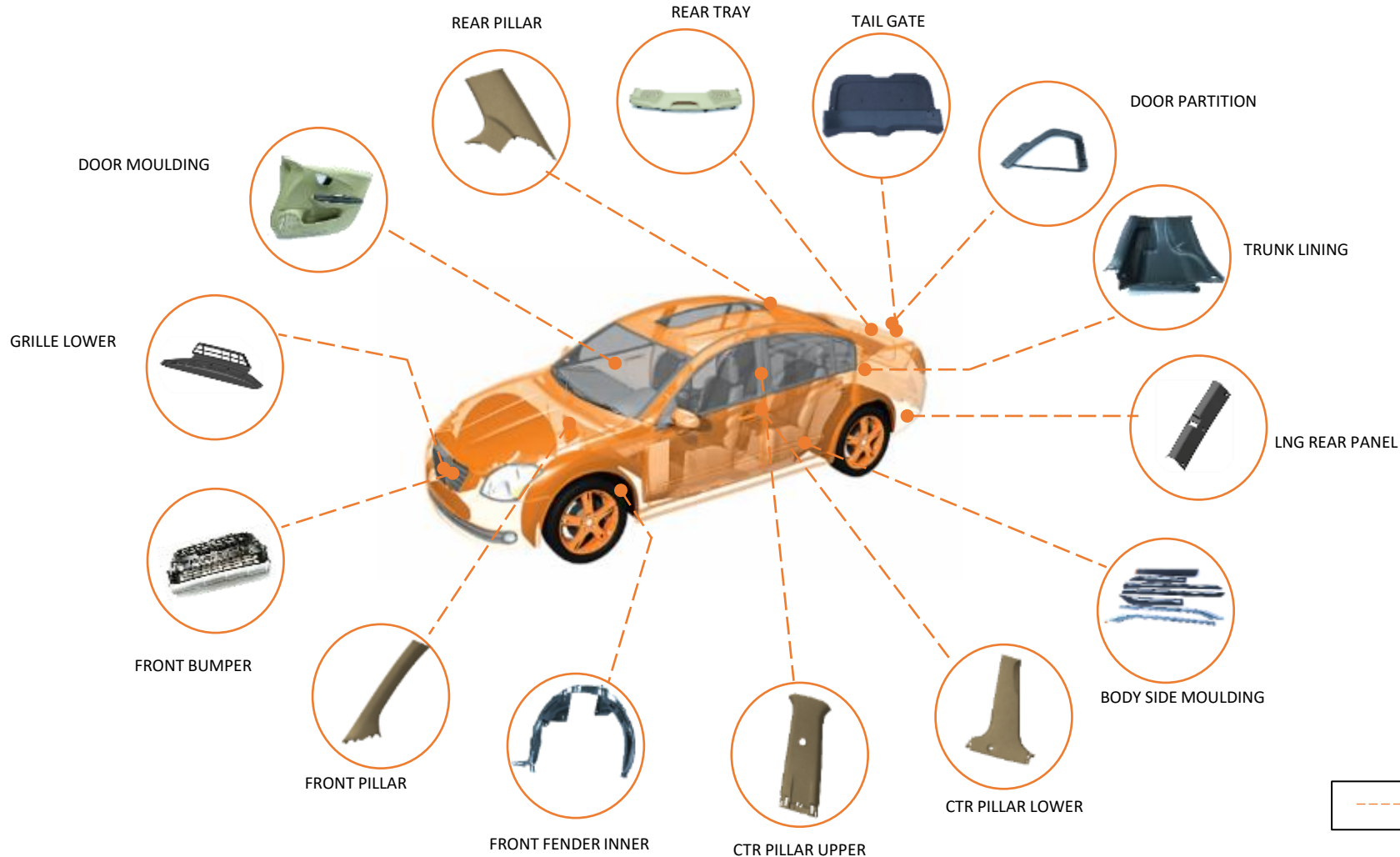

## Commercial Vehicle Product



--- Injection Moulding



# Two Wheeler Products



PPAP offers a diverse range of products that are applicable to both EV and non-EV vehicles



# EV Components – High Growth Market

PPAP intends to manufacture a variety of electric vehicle components in order to meet the growing demand for EVs

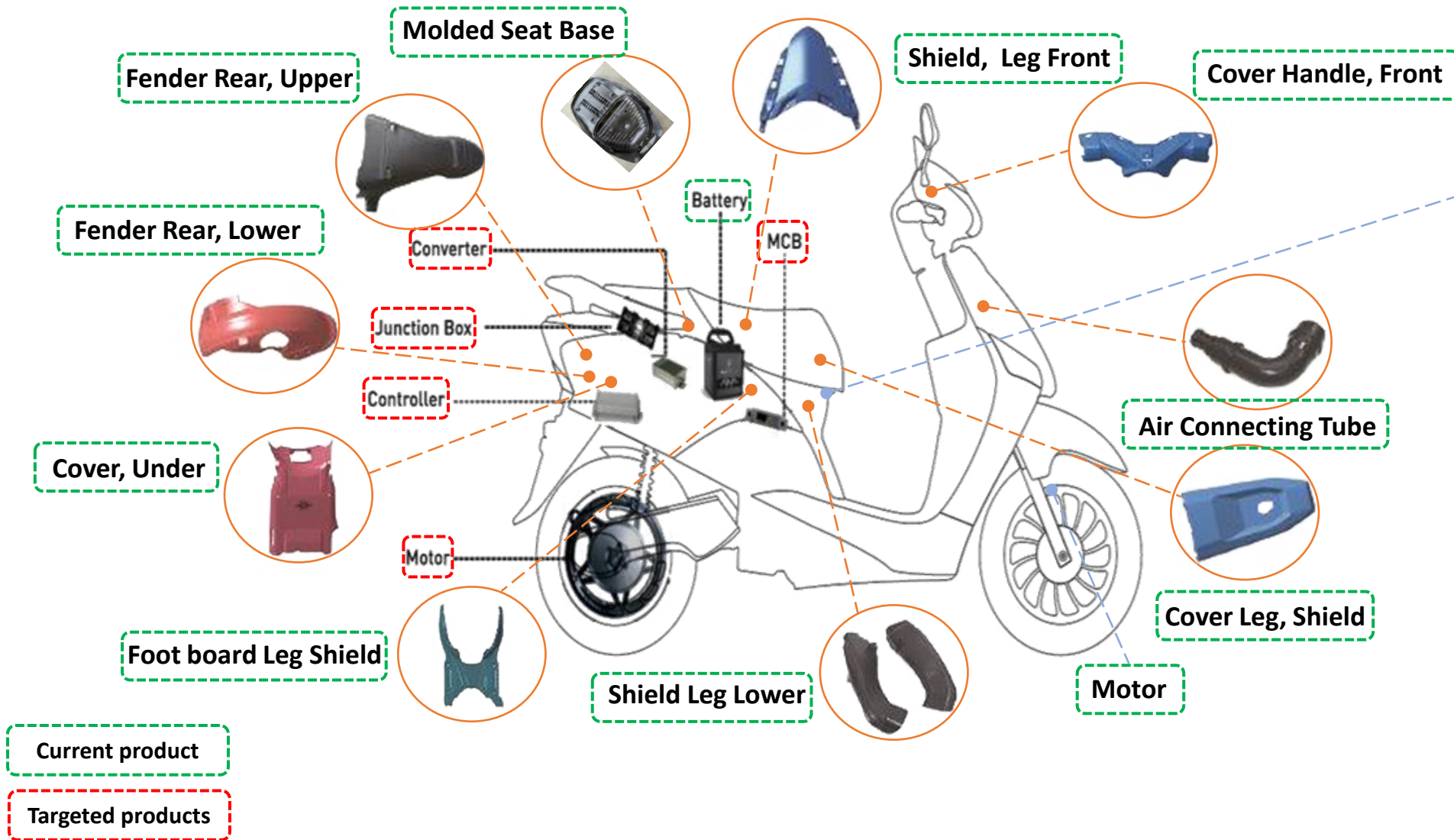

Battery Pack for Electric Vehicles



# Diversified Product Mix



## Plastic Injection Tools

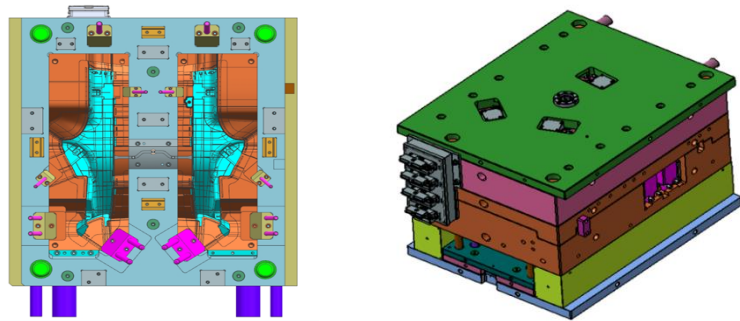
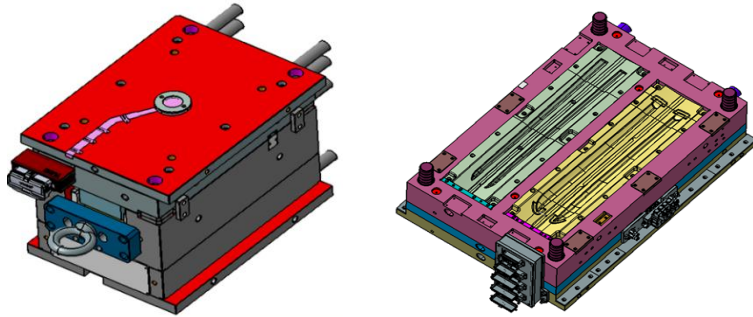

**Tonnage – Upto 850 Tons**  
**Size – 1500 (L) x 1000 (W) x 850 (H)**  
**Mould Weight – Upto 8 Ton**



## Battery Pack for Back up power



Application :



Solar Street Light



Mobile Towers



UPS

**The battery packs are used in multiple products for providing back up power**



## Pail Containers



**Containers for storing fertilizers, paints and lubricants**

# Aftermarket – A Large Opportunity

- The Company has ventured into development of parts and accessories for aftermarket.
- The products are sold through the wholly owned subsidiary Elpis Components Distributors Private Limited
- Currently, this segment contributes 3% of revenue and is expected to increase to 10% by FY24

## Distribution Network

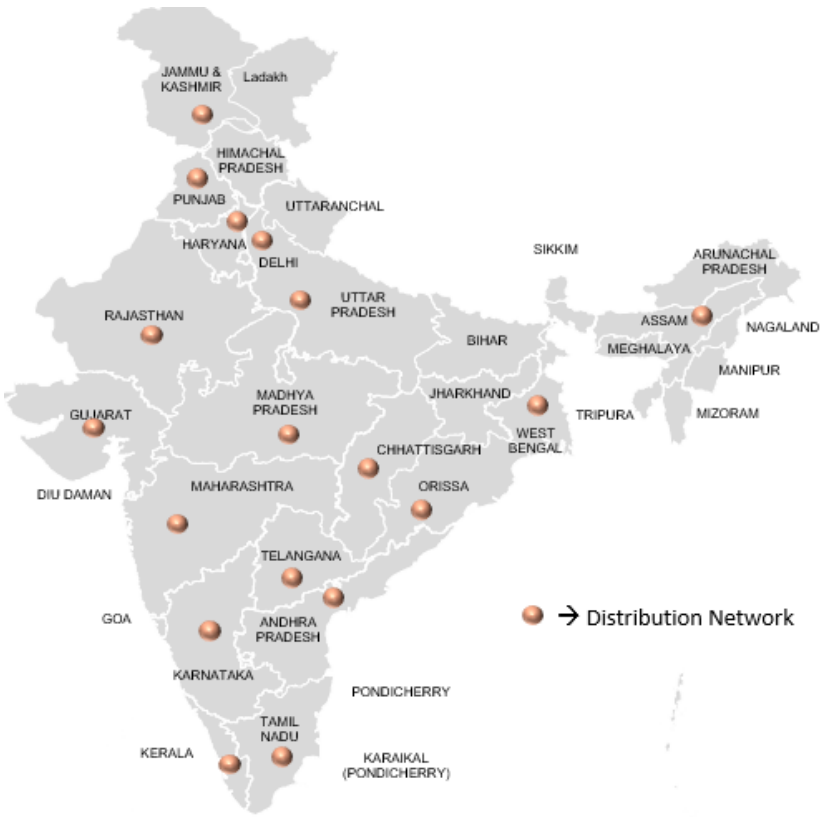

## Car Accessories



- Interior accessories – Phone holder, Rear tray, charger sockets, Perfumes
- Range of cleaning products

## Shopelpis.com

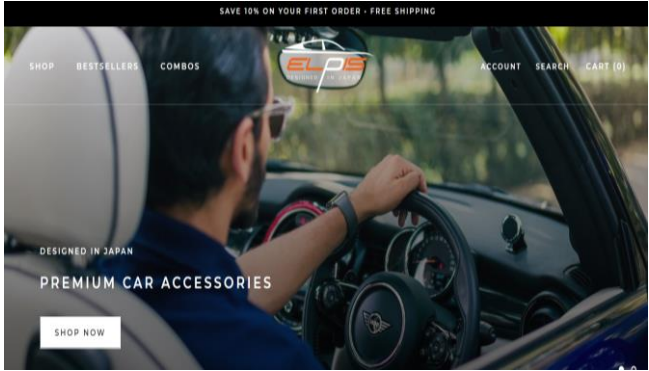

## Amazon.com

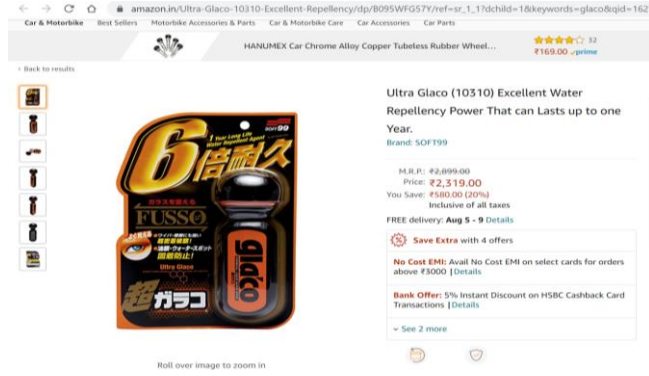



# Esteemed Clientele

## Passenger Vehicle

## Two Wheeler

## Commercial Vehicle

## Battery Packs – EV Two Wheelers

## Battery Packs – Storage System

## Pail Containers

## Tooling



Note - The Brand Names mentioned are the property of their respective owners and are used here for identification purposes only





# Growth Roadmap – Explore, Expand & Excel



## Strengthen and grow Automotive Parts business

- Development of value-added parts that will command higher prices and contribute to higher margins
- Increase per car value for existing customers and continue to add new customers
- Future ready processes with manufacturing excellence and digitization

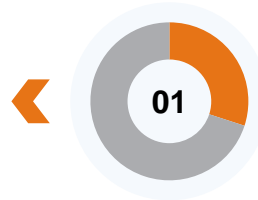

## Unlocking hidden potential for tooling business

- Develop plastic injection tooling business as a profit center
- Explore opportunities in Automotive, White Goods and Electrical segments

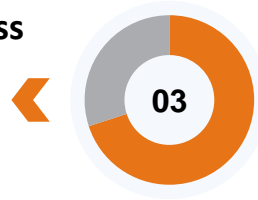

## Develop product portfolio for Electric Vehicles

- Develop customers making Electric Vehicles for the existing product range (Body Sealing Products and Interior and Exterior Injection Products)
- Develop special products focusing on 2-Wheeler and 3-Wheeler requirements (like Battery Pack, motor controllers etc)

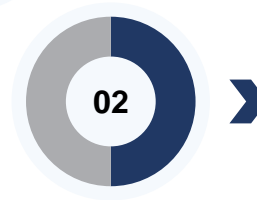
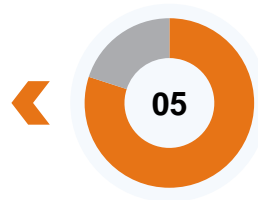

## Market Place Enhancement

- Explore new market avenues for existing products
- Develop new products focusing on after market
- Develop after market customers through distribution partners and direct online sales channels

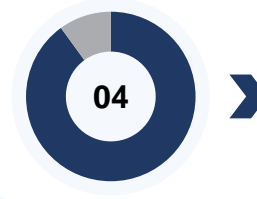

## Diversification in the neighbouring industries

- Explore opportunities to promote core competence of the company in neighboring industries (Extrusion and Injection Molding)
- Develop value added products for various sectors like Packaging, Medical, Railways, Construction etc...

# Why Trust PPAP... at a glance

01

## Continuous improvement of operational efficiency

- Cost sensitive working culture
- International benchmarking
- Implementation of TPS & TBP (Toyota Production System & Toyota Business Practices)
- Focus on Human Development – Development of Mind, Body and Intellect
- Optimize use of resources

02

## Portfolio approach to margin-rich blended product mix

- The Company has a portfolio approach to building a healthy mix of premium-priced value added products and budget-priced mould parts
- The Company's product mix is carefully blended to ensure PPAP is able to make healthy overall margins at a portfolio level

03

## Organic growth complemented by adding new clients and geographies

- The Company presently caters to marquee OEMs such as Maruti Suzuki, Honda, Hyundai, Tata etc.
- Continuously explore and add new customers, while consistently expanding its per car share within the existing OEMs organically
- Developing value added products through inhouse Research and Technical Development capabilities
- Operations closer to the customer

04

## Sound financials giving headroom to fund its growth

- A strong financial discipline coupled with the ability to generate regular free cash flows, allows PPAP to adequately fund its growth organically
- Low debt ratios
- Focus on improvement of return ratios
- Focus on "Every Paisa Counts"

# ESG Initiatives

## Environment

- PPAP is dedicated to reducing the environmental footprint through an efficient and process-oriented approach
- PPAP has been taking initiatives for reducing energy consumption and GHG emissions by installing rooftop solar and introducing various energy efficient technology
- Focus on waste management and water resource management



## Social

- PPAP is committed to constantly improve employee development in the skill & talent management cycle from employment, growth and retention through training & user-friendly technology
- Promotes gender diversity and has hired women at shop floor as well as Corporate office
- CSR activities done through Vinay & Ajay Jain Foundation in the field of Environment, education and healthcare



# Robust Governance Framework

## Governance

- PPAPs philosophy for governance aims to achieve the highest standards of corporate governance, accountability, sustainability and compliance of all the laws in the letter and spirit
- PPAP strongly believes that effective and good corporate governance practices build a strong foundation of trust and confidence, attracting human capital, leading to sustainable and superior performance
- There are various committees that play a crucial role in the governance structure of the Company and have been constituted to deal with specific areas and activities which concern the Company
- PPAP has established a risk management framework that enables regular and active monitoring of business activities to identify, assess and mitigate potential internal or external risks
- The Company has a code of conduct for all employees, including the Board and senior management personnel. All members of the Board and Senior Management personnel have affirmed compliance with the said code of conduct





**Historical  
Financials**





# Standalone P&L



| Particulars (INR Cr)           | FY22         | FY21         | FY20         | FY19         |
|--------------------------------|--------------|--------------|--------------|--------------|
| <b>Revenue from operations</b> | <b>409.1</b> | <b>321.2</b> | <b>360.0</b> | <b>411.0</b> |
| COGS                           | 247.1        | 182.6        | 195.9        | 210.6        |
| <b>Gross Profit</b>            | <b>162.0</b> | <b>138.5</b> | <b>164.1</b> | <b>200.4</b> |
| <b>Gross Profit Margin</b>     | <b>39.6%</b> | <b>43.1%</b> | <b>45.6%</b> | <b>48.8%</b> |
| Employee Expenses              | 69.6         | 61.2         | 66.1         | 71.3         |
| Other Expenses                 | 53.3         | 43.6         | 47.3         | 51.9         |
| <b>EBITDA</b>                  | <b>39.0</b>  | <b>33.7</b>  | <b>50.7</b>  | <b>77.2</b>  |
| <b>EBITDA Margin</b>           | <b>9.5%</b>  | <b>10.5%</b> | <b>14.1%</b> | <b>18.8%</b> |
| Other Income                   | 2.0          | 2.6          | 0.7          | 1.1          |
| Depreciation                   | 29.0         | 26.3         | 25.7         | 26.0         |
| Finance Cost                   | 6.0          | 3.7          | 2.6          | 4.0          |
| <b>Profit before Tax</b>       | <b>6.1</b>   | <b>6.3</b>   | <b>23.1</b>  | <b>48.2</b>  |
| Tax expenses                   | 1.5          | 1.5          | 3.8          | 14.8         |
| <b>Profit for the year</b>     | <b>4.6</b>   | <b>4.8</b>   | <b>19.3</b>  | <b>33.4</b>  |
| <b>PAT Margins</b>             | <b>1.1%</b>  | <b>1.5%</b>  | <b>5.3%</b>  | <b>8.1%</b>  |
| EPS                            | 3.3          | 3.5          | 13.8         | 23.8         |

# Standalone Balance sheet



| Liabilities (INR Cr)                 | Mar-22       | Mar-21       | Mar-20       | Mar-19       |
|--------------------------------------|--------------|--------------|--------------|--------------|
| <b>Equity</b>                        |              |              |              |              |
| Equity Share capital                 | 14.0         | 14.0         | 14.0         | 14.0         |
| Other Equity                         | 298.8        | 295.8        | 290.2        | 281.1        |
| Non Controlling Interest             | 0.0          | 0.0          | 0.0          | 0.0          |
| <b>Total Equity</b>                  | <b>312.8</b> | <b>309.8</b> | <b>304.2</b> | <b>295.1</b> |
| <b>Financial liabilities</b>         |              |              |              |              |
| (i) Borrowings                       | 72.4         | 42.3         | 12.0         | 12.9         |
| (ii) Other Financial liabilities     | 0.5          | 0.0          | 0.0          | 0.0          |
| Provisions                           | 6.3          | 7.3          | 9.5          | 0.0          |
| Other non current Liability          | 0.0          | 0.0          | 0.0          | 7.1          |
| Deferred tax liabilities (Net)       | 7.1          | 7.0          | 7.0          | 9.1          |
| <b>Total Non Current Liabilities</b> | <b>86.6</b>  | <b>56.6</b>  | <b>28.5</b>  | <b>29.1</b>  |
| <b>Financial liabilities</b>         |              |              |              |              |
| (i) Borrowings                       | 19.4         | 7.3          | 9.9          | 3.8          |
| (ii) Trade Payables                  | 46.9         | 47.8         | 41.6         | 40.2         |
| (iii) Other financial liabilities    | 5.8          | 7.7          | 4.2          | 23.8         |
| (iv) Lease liabilities               | 0.5          | 0.0          | 1.0          | 0.0          |
| Provisions                           | 0.8          | 0.8          | 1.0          | 0.9          |
| Other current liabilities            | 17.5         | 13.5         | 17.0         | 21.6         |
| Current tax liabilities (Net)        | 0.0          | 0.7          | 0.2          | 0.3          |
| <b>Total Current Liabilities</b>     | <b>90.9</b>  | <b>77.8</b>  | <b>73.8</b>  | <b>90.6</b>  |
| <b>Total Equity and Liabilities</b>  | <b>490.3</b> | <b>444.2</b> | <b>406.5</b> | <b>414.8</b> |

| Assets (INR Cr)                     | Mar-22       | Mar-21       | Mar-20       | Mar-19       |
|-------------------------------------|--------------|--------------|--------------|--------------|
| <b>Non Current Assets</b>           |              |              |              |              |
| Property, Plant and Equipment       | 261.4        | 230.6        | 221.7        | 231.2        |
| Capital work-in-progress            | 20.8         | 20.1         | 7.9          | 0.5          |
| Other Intangible Asset              | 8.8          | 8.9          | 8.5          | 6.0          |
| Investment Property                 | 1.1          | 0.0          | 0.0          | 0.0          |
| Intangible assets Under Development | 0.0          | 0.2          | 0.0          | 1.8          |
| Right of Use Asset                  | 1.1          | 0.0          | 0.0          | 0.0          |
| <b>Financial Assets</b>             |              |              |              |              |
| (i) Investments                     | 63.0         | 55.3         | 50.8         | 48.5         |
| (ii) Loans                          | 0.0          | 1.8          | 2.1          | 2.2          |
| (iii) Other financial assets        | 3.7          | 3.0          | 2.4          | 2.6          |
| Deferred Tax Assets (net)           | 0.0          | 0.0          | 0.0          | 0.0          |
| Other non-current assets            | 10.3         | 11.0         | 8.7          | 4.7          |
| <b>Total Non Current Assets</b>     | <b>370.2</b> | <b>330.6</b> | <b>302.0</b> | <b>297.6</b> |
| <b>Current Assets</b>               |              |              |              |              |
| Inventories                         | 42.9         | 41.8         | 48.8         | 45.0         |
| <b>Financial Assets</b>             |              |              |              |              |
| Investments                         | 2.7          | 0.0          | 0.0          | 0.0          |
| (i) Trade receivables               | 52.2         | 61.9         | 41.1         | 57.4         |
| (ii) Cash and cash equivalents      | 0.2          | 1.0          | 2.1          | 0.4          |
| (iii) Other bank balances           | 0.1          | 0.1          | 2.9          | 0.1          |
| (iv) Loans                          | 7.5          | 0.5          | 0.4          | 0.4          |
| (v) Other financial assets          | 1.8          | 0.5          | 0.5          | 4.4          |
| Current Tax Assets(Net)             | 1.2          | 0.0          | 0.0          | 0.0          |
| Other current assets                | 11.5         | 7.6          | 8.7          | 9.5          |
| <b>Total Current Assets</b>         | <b>120.1</b> | <b>113.6</b> | <b>104.5</b> | <b>117.2</b> |
| <b>Total Assets</b>                 | <b>490.3</b> | <b>444.2</b> | <b>406.5</b> | <b>414.8</b> |



# Standalone Cash Flow



| Particulars (INR Cr)  | Mar-22       | Mar-21       | Mar-20       | Mar-19       |
|---|--------------|--------------|--------------|--------------|
| <b>Net Profit Before Tax</b>  | <b>6.1</b>   | <b>6.3</b>   | <b>23.1</b>  | <b>48.2</b>  |
| Adjustments for: Non Cash Items / Other Investment or Financial Items | 31.5         | 27.0         | 27.8         | 29.8         |
| <b>Operating profit before working capital changes</b>                | <b>37.6</b>  | <b>33.3</b>  | <b>50.9</b>  | <b>78.0</b>  |
| Changes in working capital  | -0.7         | -2.2         | -2.5         | -2.4         |
| <b>Cash generated from Operations</b>                                 | <b>36.9</b>  | <b>31.2</b>  | <b>48.4</b>  | <b>75.6</b>  |
| Direct taxes paid (net of refund)                                     | -3.4         | -1.1         | -12.2        | -16.9        |
| <b>Net Cash from Operating Activities</b>                             | <b>33.4</b>  | <b>30.1</b>  | <b>36.2</b>  | <b>58.7</b>  |
| <b>Net Cash from Investing Activities</b>                             | <b>-70.2</b> | <b>-49.4</b> | <b>-29.2</b> | <b>-43.1</b> |
| <b>Net Cash from Financing Activities</b>                             | <b>36.0</b>  | <b>18.3</b>  | <b>-5.4</b>  | <b>-16.5</b> |
| <b>Net Increase in Cash and Cash equivalents</b>                      | <b>-0.8</b>  | <b>-1.1</b>  | <b>1.7</b>   | <b>-0.9</b>  |
| Add: Cash & Cash equivalents at the beginning of the period           | 1.0          | 2.1          | 0.4          | 1.4          |
| <b>Cash &amp; Cash equivalents at the end of the period</b>           | <b>0.2</b>   | <b>1.0</b>   | <b>2.1</b>   | <b>0.4</b>   |





# Consolidated P&L



| Particulars (INR Cr)           | FY22         | FY21         | FY20         | FY19         |
|--------------------------------|--------------|--------------|--------------|--------------|
| <b>Revenue from operations</b> | <b>421.9</b> | <b>322.2</b> | <b>359.5</b> | <b>411.0</b> |
| COGS                           | 255.8        | 183.0        | 195.2        | 210.6        |
| <b>Gross Profit</b>            | <b>166.1</b> | <b>139.2</b> | <b>164.3</b> | <b>200.4</b> |
| <b>Gross Profit Margin</b>     | <b>39.4%</b> | <b>43.2%</b> | <b>45.7%</b> | <b>48.8%</b> |
| Employee Expenses              | 72.2         | 62.2         | 66.2         | 71.3         |
| Other Expenses                 | 55.2         | 44.1         | 47.4         | 51.9         |
| <b>EBITDA</b>                  | <b>38.6</b>  | <b>32.9</b>  | <b>50.7</b>  | <b>77.2</b>  |
| <b>EBITDA Margin</b>           | <b>9.1%</b>  | <b>10.2%</b> | <b>14.1%</b> | <b>18.8%</b> |
| Other Income                   | 1.0          | 2.1          | 0.6          | 1.1          |
| Depreciation                   | 29.5         | 26.5         | 25.7         | 26.0         |
| Finance Cost                   | 6.5          | 3.8          | 2.6          | 4.0          |
| <b>Profit before Tax</b>       | <b>0.1</b>   | <b>3.2</b>   | <b>22.0</b>  | <b>48.6</b>  |
| Tax expenses                   | 0.9          | 1.1          | 3.8          | 14.8         |
| <b>Profit for the year</b>     | <b>-0.8</b>  | <b>2.1</b>   | <b>18.2</b>  | <b>33.7</b>  |
| <b>PAT Margins</b>             | <b>-0.2%</b> | <b>0.7%</b>  | <b>5.1%</b>  | <b>8.2%</b>  |
| EPS                            | -0.6         | 1.5          | 13.0         | 24.1         |

# Consolidated Balance sheet



| Liabilities (INR Cr)                 | Mar-22       | Mar-21       | Mar-20       | Mar-19       |
|--------------------------------------|--------------|--------------|--------------|--------------|
| <b>Equity</b>                        |              |              |              |              |
| Equity Share capital                 | 14.0         | 14.0         | 14.0         | 14.0         |
| Other Equity                         | 289.9        | 292.2        | 289.2        | 281.4        |
| Non Controlling Interest             | 0.0          | 0.0          | 0.0          | 0.0          |
| <b>Total Equity</b>                  | <b>303.9</b> | <b>306.2</b> | <b>303.2</b> | <b>295.4</b> |
| <b>Financial liabilities</b>         |              |              |              |              |
| (i) Borrowings                       | 78.9         | 44.6         | 12.0         | 12.9         |
| (ii) Lease liabilities               | 0.9          | 0.0          | 0.0          | 0.0          |
| (iii) Other Financial liabilities    | 0.1          | 0.0          | 0.0          | 0.0          |
| Provisions                           | 6.4          | 7.3          | 9.5          | 7.1          |
| Other non current Liability          | 0.0          | 0.0          | 0.0          | 0.0          |
| Deferred tax liabilities (Net)       | 6.0          | 6.7          | 7.0          | 9.1          |
| <b>Total Non Current Liabilities</b> | <b>92.2</b>  | <b>58.5</b>  | <b>28.5</b>  | <b>29.1</b>  |
| <b>Financial liabilities</b>         |              |              |              |              |
| (i) Borrowings                       | 29.2         | 7.6          | 9.9          | 3.8          |
| (ii) Trade Payables                  | 48.6         | 47.9         | 41.9         | 40.2         |
| (iii) Other financial liabilities    | 6.4          | 7.9          | 4.3          | 23.8         |
| (iv) Lease liabilities               | 0.8          | 0.0          | 0.0          | 0.0          |
| Provisions                           | 0.9          | 0.8          | 1.0          | 0.9          |
| Other current liabilities            | 17.7         | 13.6         | 17.0         | 21.6         |
| Current tax liabilities (Net)        | 0.0          | 0.7          | 0.1          | 0.3          |
| <b>Total Current Liabilities</b>     | <b>102.7</b> | <b>78.5</b>  | <b>74.1</b>  | <b>90.6</b>  |
| <b>Total Equity and Liabilities</b>  | <b>499.5</b> | <b>443.2</b> | <b>405.8</b> | <b>415.1</b> |

| Assets (INR Cr)                     | Mar-22       | Mar-21       | Mar-20       | Mar-19       |
|-------------------------------------|--------------|--------------|--------------|--------------|
| <b>Non Current Assets</b>           |              |              |              |              |
| Property, Plant and Equipment       | 273.9        | 234.9        | 221.7        | 231.2        |
| Capital work-in-progress            | 20.8         | 20.1         | 8.4          | 0.5          |
| Other Intangible Asset              | 8.8          | 9.0          | 8.5          | 6.0          |
| Intangible assets Under Development | 0.7          | 0.2          | 0.0          | 1.8          |
| Right of Use Asset                  | 1.6          | 0.0          | 0.0          | 0.0          |
| <b>Financial Assets</b>             |              |              |              |              |
| (i) Investments                     | 42.9         | 46.4         | 47.9         | 48.8         |
| (ii) Loans                          | 0.0          | 1.8          | 2.1          | 2.2          |
| (iii) Other financial assets        | 5.1          | 3.0          | 2.4          | 2.6          |
| Deferred Tax Assets (net)           | 0.0          | 0.0          | 0.0          | 0.0          |
| Other non-current assets            | 10.3         | 10.7         | 8.7          | 4.7          |
| <b>Total Non Current Assets</b>     | <b>364.2</b> | <b>326.1</b> | <b>299.7</b> | <b>297.9</b> |
| <b>Current Assets</b>               |              |              |              |              |
| Inventories                         | 56.1         | 45.0         | 49.6         | 45.0         |
| <b>Financial Assets</b>             |              |              |              |              |
| Investments                         | 2.7          | 0.0          | 0.0          | 0.0          |
| (i) Trade receivables               | 55.9         | 60.4         | 40.0         | 57.4         |
| (ii) Cash and cash equivalents      | 0.4          | 1.3          | 3.2          | 0.4          |
| (iii) Other bank balances           | 0.1          | 0.2          | 2.9          | 0.1          |
| (iv) Loans                          | 0.0          | 0.5          | 0.4          | 0.4          |
| (v) Other financial assets          | 1.8          | 1.7          | 0.5          | 4.4          |
| Current Tax Assets(Net)             | 1.2          | 0.0          | 0.0          | 0.0          |
| Other current assets                | 17.2         | 8.1          | 9.6          | 9.5          |
| <b>Total Current Assets</b>         | <b>135.4</b> | <b>117.2</b> | <b>106.1</b> | <b>117.2</b> |
| <b>Total Assets</b>                 | <b>499.5</b> | <b>443.3</b> | <b>405.8</b> | <b>415.1</b> |

# Consolidated Cash Flow



| Particulars (INR Cr)  | Mar-22       | Mar-21       | Mar-20       | Mar-19       |
|---|--------------|--------------|--------------|--------------|
| <b>Net Profit Before Tax</b>  | <b>0.1</b>   | <b>3.2</b>   | <b>22.0</b>  | <b>48.2</b>  |
| Adjustments for: Non Cash Items / Other Investment or Financial Items | 36.7         | 28.6         | 28.7         | 29.8         |
| <b>Operating profit before working capital changes</b>                | <b>36.9</b>  | <b>31.9</b>  | <b>50.7</b>  | <b>78.0</b>  |
| Changes in working capital  | -12.3        | -4.4         | -2.7         | -2.2         |
| <b>Cash generated from Operations</b>                                 | <b>24.6</b>  | <b>27.5</b>  | <b>48.0</b>  | <b>75.7</b>  |
| Direct taxes paid (net of refund)                                     | 3.6          | -1.1         | -12.2        | -16.9        |
| <b>Net Cash from Operating Activities</b>                             | <b>21.0</b>  | <b>26.4</b>  | <b>35.9</b>  | <b>58.8</b>  |
| <b>Net Cash from Investing Activities</b>                             | <b>-70.9</b> | <b>-48.9</b> | <b>-27.5</b> | <b>-43.1</b> |
| <b>Net Cash from Financing Activities</b>                             | <b>41.9</b>  | <b>20.6</b>  | <b>-5.6</b>  | <b>-16.6</b> |
| <b>Net Increase in Cash and Cash equivalents</b>                      | <b>-0.9</b>  | <b>-1.9</b>  | <b>2.8</b>   | <b>-0.9</b>  |
| Add: Cash & Cash equivalents at the beginning of the period           | 1.3          | 3.2          | 0.4          | 1.4          |
| <b>Cash &amp; Cash equivalents at the end of the period</b>           | <b>0.4</b>   | <b>1.3</b>   | <b>3.2</b>   | <b>0.4</b>   |



For further information, please contact

---

**Company :**



CIN: L74899DL1995PLC073281

Ms. Pankhuri Agarwal  
[investorservice@ppapco.com](mailto:investorservice@ppapco.com)

[www.ppapco.in](http://www.ppapco.in)

**Investor Relations Advisors :**

**SGA** Strategic Growth Advisors

CIN: U74140MH2010PTC204285

Mr. Aakash Mehta / Mr. Rahul Agarwal  
[aakash.s.m@sgapl.net](mailto:aakash.s.m@sgapl.net) / [rahul.agarwal@sgapl.net](mailto:rahul.agarwal@sgapl.net)  
+91 98706 79263 / +91 98214 38864

[www.sgapl.net](http://www.sgapl.net)