



Ref: Sec/Sto/2022/11/05

November 11, 2022

Corporate Relationship Department

BSE Limited

Phiroze Jeejeebhoy Towers

Dalal Street, Mumbai – 400001

Dear Sir / Madam,

Subject: Proceedings of 57th Annual General Meeting of Kennametal India Limited held on November 11, 2022 [Scrip Code – 505890]

Ref: Disclosure under Regulation 30 of SEBI (Listing Obligations and Disclosure Requirements) Regulations, 2015

Pursuant to the provisions of Regulation 30 read with Schedule III Para A of Part A of SEBI (Listing Obligations and Disclosure Requirements) Regulations, 2015, please find below the proceedings of the 57th Annual General Meeting (“AGM”) of the Company held on Friday, November 11, 2022 at 12:00 Noon through Video Conferencing (“VC”) / other Audio- Visual Means (“OAVM”):

Proceedings of 57th Annual General Meeting (AGM) held on November 11, 2022:

The 57th Annual General Meeting (“AGM”) of the shareholders of Kennametal India Limited (the “**Company**”) was held on Friday, November 11, 2022 at 12:00 Noon through Video Conferencing (“VC”).

Mr. B. Anjani Kumar, Independent Director & Chairman of the Board chaired the AGM.

The requisite quorum being present, the Chairman called the AGM to order.

- Mr. Naveen Chandra, Company Secretary of the Company gave the safety briefing and general advisory to all the shareholders and attendees who had participated in the AGM.
- Chairman introduced the Directors present at the AGM.
- Chairman thereafter, delivered his speech.

- Chairman thereafter invited Mr. Vijaykrishnan Venkatesan, Managing Director of the Company to present an overview of the performance of the Company for Financial Year 2022, which covered Company's efforts in the area of finance, ESG, people, community and customer.
- Chairman resumed the proceedings of the meeting. With the consent of the shareholders, the Notice convening the AGM was taken as read.

Thereafter, following items were put forth as set out in the Notice as transacted in the AGM:

Ordinary Business:

1. To receive, consider and adopt:
 - a) the Audited Standalone Financial Statements of the Company for the financial year ended June 30, 2022, together with the Reports of the Board of Directors and the Auditors thereon. **(Ordinary Resolution)**.
 - b) the Audited Consolidated Financial Statements of the Company for the financial year ended June 30, 2022 together with the Report of Auditors thereon. **(Ordinary Resolution)**.
2. To appoint Mr. Devi Parameswar Reddy (DIN: 03450016), Director, who retires by rotation and being eligible, offers himself for re - appointment. **(Ordinary Resolution)**.
3. To confirm the interim dividend of ₹24/- per Equity Share (240%) on 2,19,78,240 Equity Shares of ₹10/- each already paid for the financial year 2021-22 (year ended June 30, 2022). **(Ordinary Resolution)**.
4. To appoint Messrs. Price Waterhouse & Co. Chartered Accountants LLP., (Firm Registration No. 304026E / E-300009), as Statutory Auditors of the company for a period of 5 (five) years and to fix their remuneration. **(Ordinary Resolution)**.

Special Business:

5. Ratification of remuneration to Cost Auditors. **(Ordinary Resolution)**.

For the below stated business, Mr. B Anjani Kumar recused himself to chair and requested Mr. Franklin Cardenas to chair the proceedings of the AGM.

6. To approve the payment of commission, to the Chairman, exceeding fifty percent (50%) of the total commission payable to all other Independent Directors. **(Special Resolution)**.

Questions posed by shareholders orally during the meeting and which were received by the management in writing prior to the meeting were duly answered to the satisfaction of all the shareholders. The shareholders appreciated the efforts of the management in sending the annual report well ahead of the timelines and for conducting the proceedings of the meeting seamlessly.

Mr. B Anjani Kumar, Chairman, informed the members that the e-voting results will be declared on or before November 15, 2022 on BSE Limited and also the Company's website. The Chairman thanked all the members for their participation and all the stakeholders who were responsible for outstanding performance of the company. Thereafter, the Chairman announced closure of the 57th AGM.

The Meeting commenced at 12:00 Noon and concluded at 1:25 P.M.

Please find enclosed copy of the Managing Director's presentation made at the 57th Annual General Meeting of the Company.

Kindly note that voting results will be announced upon the receipt of Scrutinizer's Report and will be submitted as per Regulation 44(3) of SEBI (Listing Obligations and Disclosure Requirements) Regulations, 2015.

Please take the documents on record and kindly treat this as compliance with SEBI (Listing Obligations and Disclosure Requirements) Regulations, 2015.

Thanking You,

Yours faithfully,

For **Kennametal India Limited**

Naveen Chandra P
General Manager – Legal & Company Secretary

Enclosure: As above

Kennametal India Limited 57th Annual General Meeting

Vijaykrishnan Venkatesan
November 2022



Disclaimer

This presentation may include statements which may constitute forward-looking statements. All statements that address expectations or projections about the future, including, but not limited to, statements about the strategy for growth, business development, market position, expenditures, and financial results, are forward looking statements. Forward looking statements are based on certain assumptions and expectations of future events and involves known and unknown risks, uncertainties and other factors. Kennametal India Limited (the “Company”) cannot guarantee that these assumptions and expectations are accurate or exhaustive or will be realized. The actual results, performance or achievements, could thus differ materially from those projected in any such forward-looking statements. No obligation is assumed by the Company to update the forward-looking statements contained herein.

The information contained in these materials have not been independently verified. None of the Company, its Directors, Promoter or affiliates, nor any of its or their respective employees, advisers or representatives or any other person accepts any responsibility or liability whatsoever, whether arising in tort, contract or otherwise, for any errors, omissions or inaccuracies in such information or opinions or for any loss, cost or damage suffered or incurred howsoever arising, directly or indirectly, from any use of this document or its contents or omission or otherwise whatsoever in connection with this document, and makes no representation or warranty, express or implied, for the contents of this document including its accuracy, fairness, completeness or verification or for any other statement made or purported to be made by any of them, or on behalf of them, and nothing in this document or at this presentation shall be relied upon as a promise or representation in this respect, whether as to the past or the future. The information and opinions contained in this presentation are current, and if not stated otherwise, as of the date of this presentation. The Company relies on information obtained from sources believed to be reliable but does not guarantee its accuracy or completeness. The Company undertake no obligation to update or revise any information or the opinions expressed in this presentation as a result of new information, future events, developments or otherwise. Any opinions or information expressed in this presentation are subject to change without notice.

Strong performance on all key parameters



Consolidated
Income in INR M



Revenue from
Operations in INR M



PBT in INR M



Active Customers



Employees

Robust financial performance

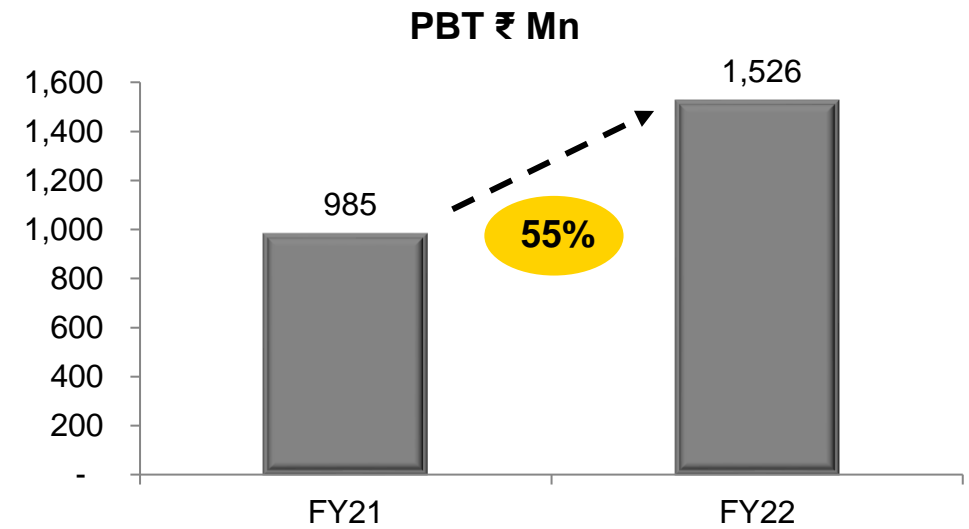
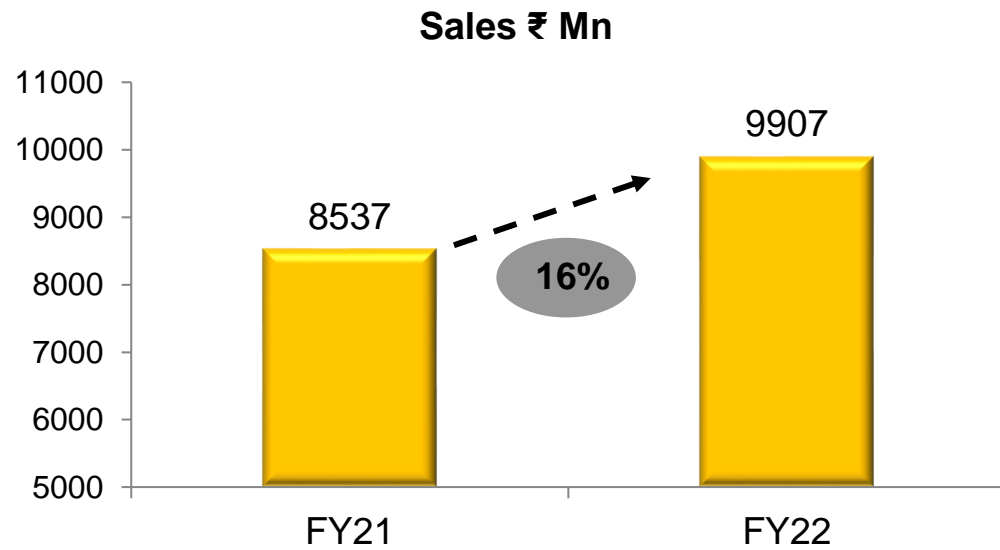

	FY21	FY22	Growth %
Sales ₹ Mn	8537	9907	16%
Profit Before Tax (PBT) ₹ Mn	985	1526	55%

EPS increased by 55.74% from Rs. 33.35 per share (FY21) to Rs. 51.94 per share (FY22)

Commercial excellence and financial prudence yield positive results

Sales (₹ Mn)

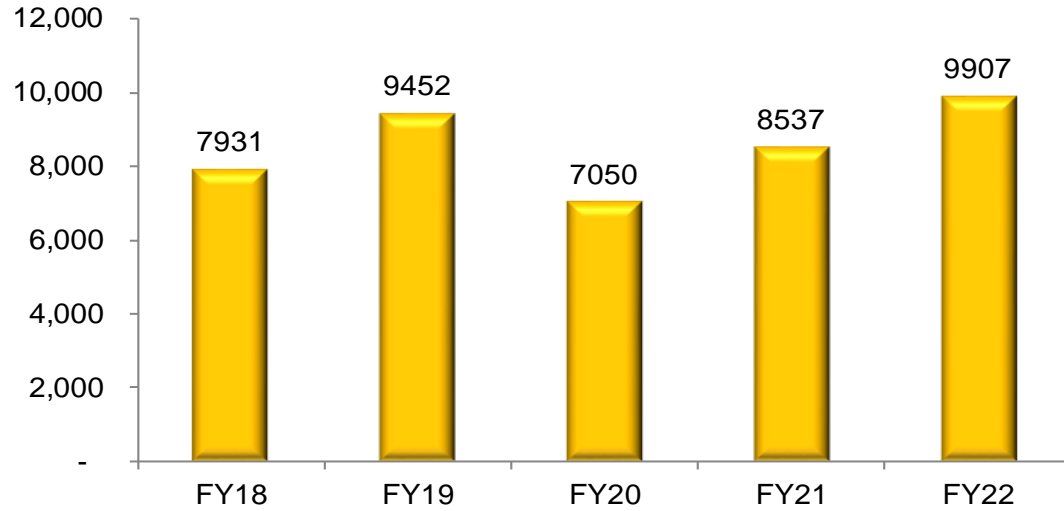

Revenue Break-up – FY22

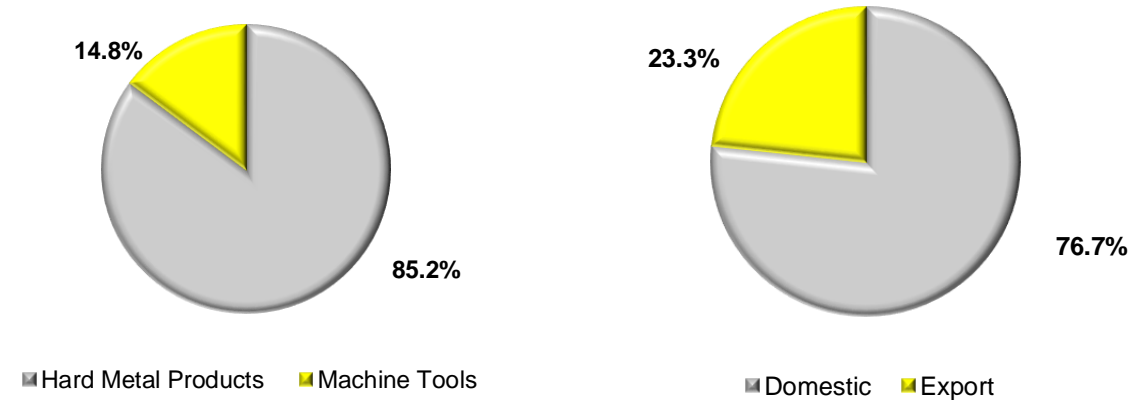

Prime Working Capital % to Sales

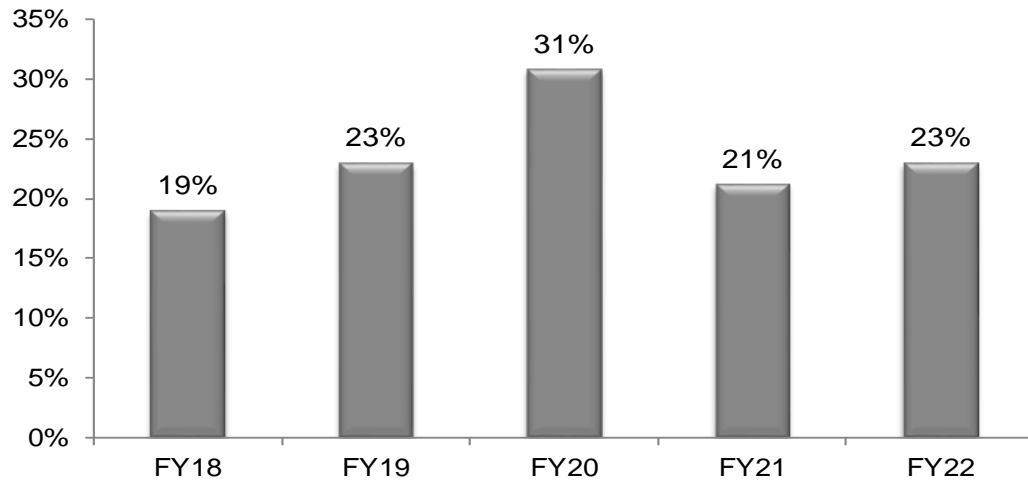

Operating Cash Flow Before Tax (₹ Mn)

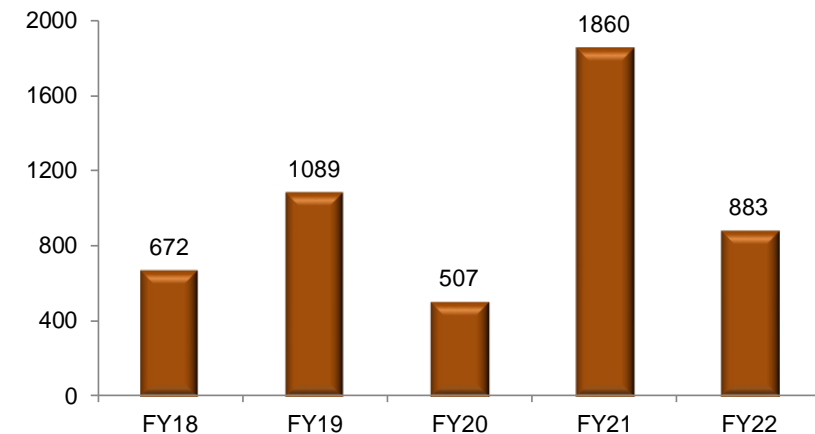

How did we grow

Delivering a comprehensive and sustainable growth



Growth driven by winning new customers & new applications

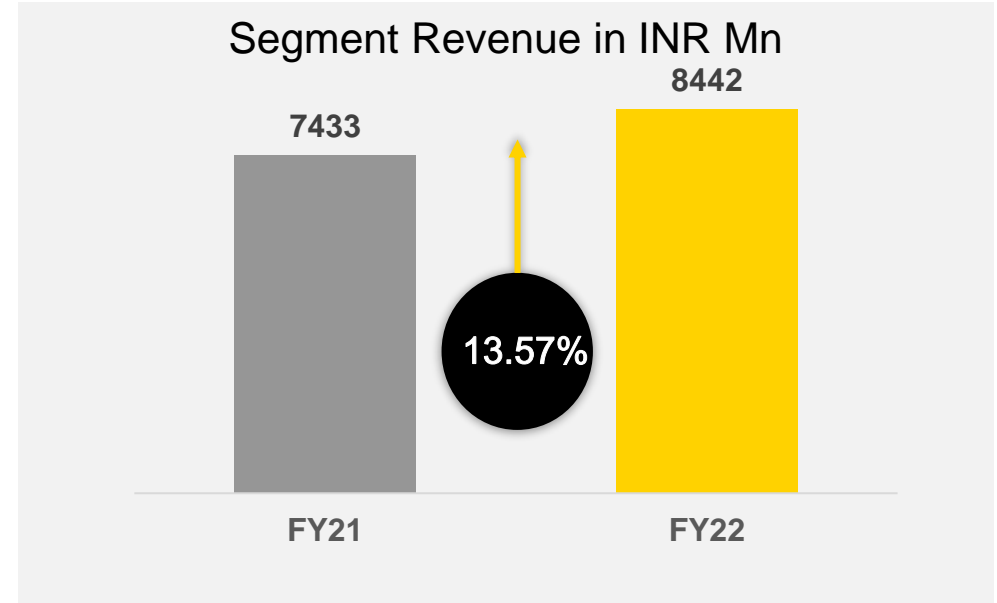

Focus on high growth segments



Developing India for India solutions

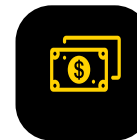

Pricing actions to protect margins

A E R O S P A C E



Kennametal offers the best performing aerospace tools for machining CFRP, titanium, aluminum, hard alloys and more.

Titanium Machining

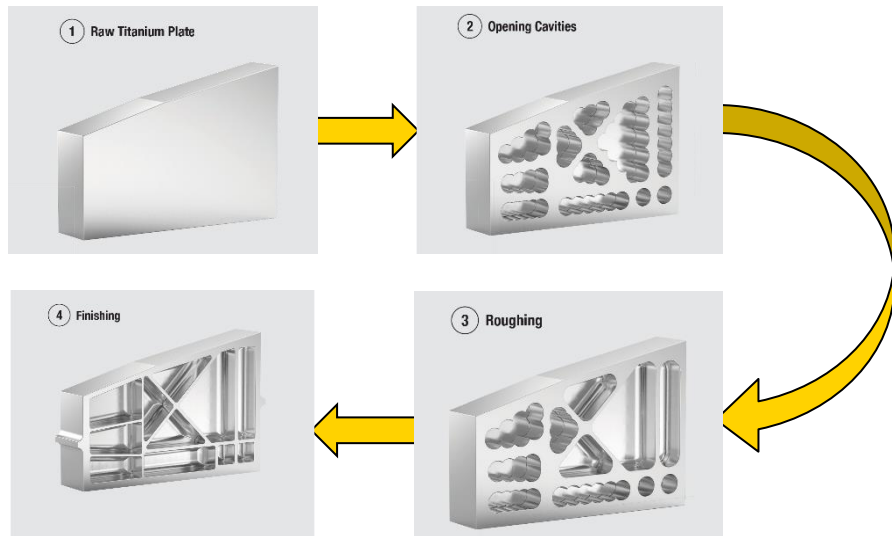

**FBX – Flat Bottom
Drill with BTF**

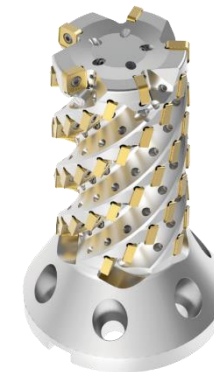

**HARVI™ Ultra 8X
with BTF**



Solid Carbide End Mills



Solutions for e-mobility
Advancing e-vehicle manufacturing

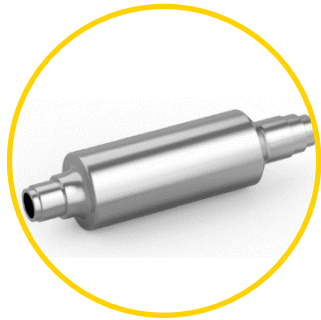

Rotor and Gear
Shaft

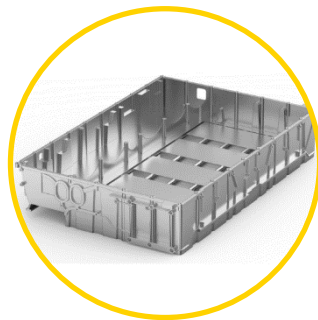

Battery Housing



Structural
Components



Stator Housing and
Transmission Case

Traditional components such as Differential Gears, Axles, CV Joint, Brakes, Drive Trains

WINNER
BI
BEST OF
INDUSTRY
AWARD

3D Printed Stator Bore
Tool from Kennametal

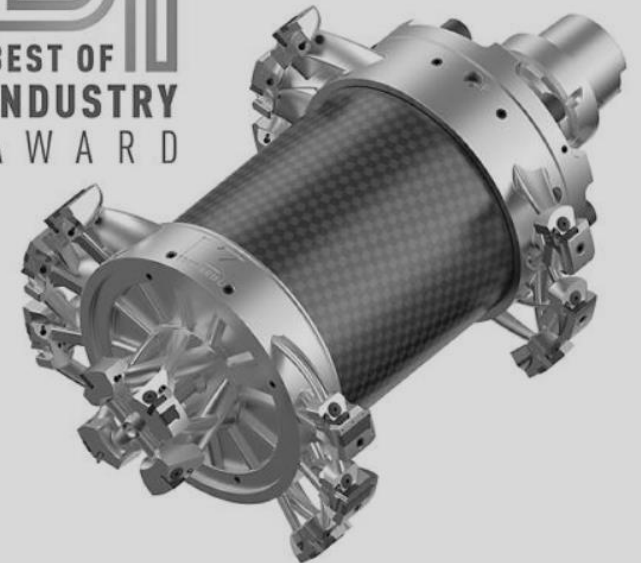

Innovative Tooling Solutions for new age materials, higher accuracy and material removal



New Launches and Horizontal Deployment of proven wear solutions

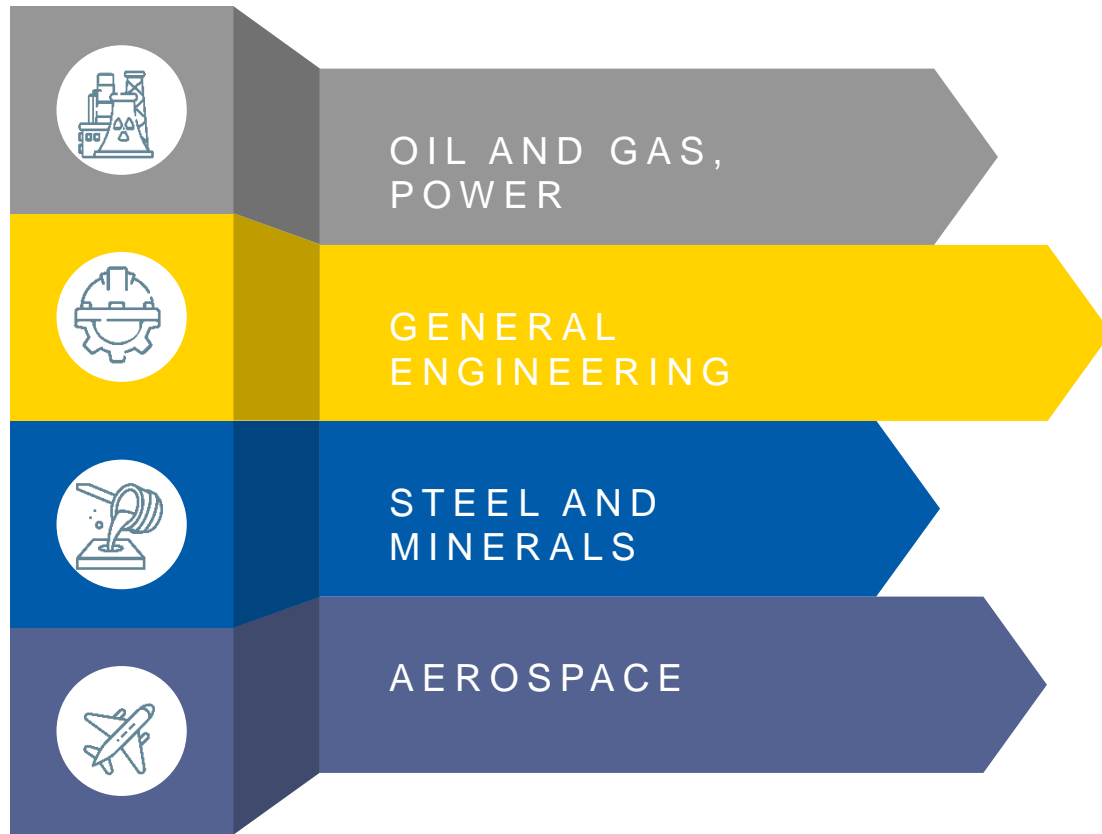

Stellite 6B



Stellite 21 wire



Combi Roll



WC Powder

Growth driving by customer base, product portfolio and APAC expansion

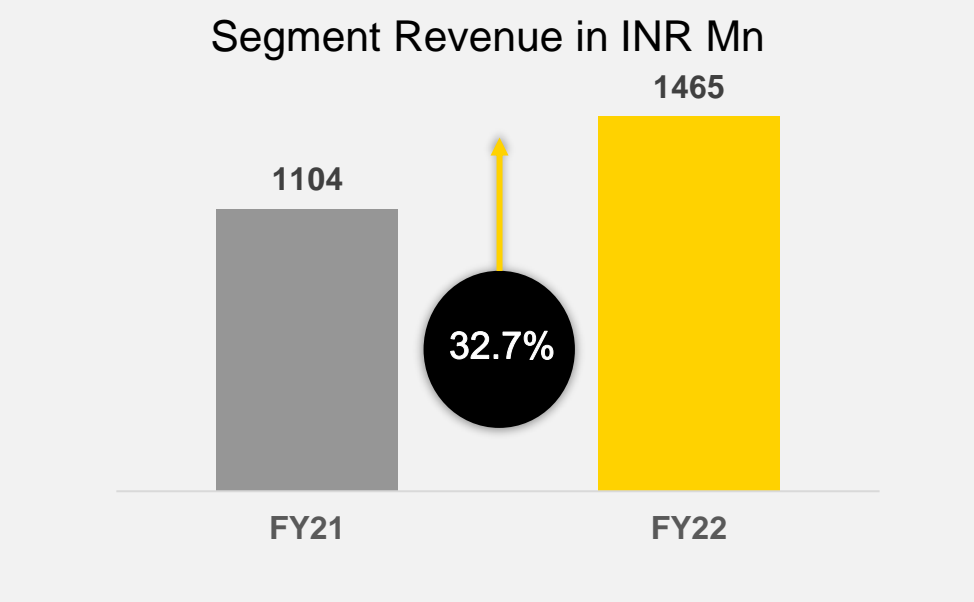

NEW PRODUCT INTRODUCTION



GEOGRAPHICAL EXPANSION



BUILDING THE BRAND

New product introductions to meet growing customer needs



- 7 axis special HMC built for a global construction equipment major
- Features 3.9 ft. x 11.8 ft. table size to accommodate massive components
 - Rigid fixtures weighing nearly 3 tons for high rigidity and along with quick change setup mechanism



5-axis Vertical Turn-mill Center for global engineering major to manufacture precision valves for the Oil & Gas

- Advanced features such as -95 to +95 degree B axis orientation, powerful spindle, Automatic Tool Changer,
- 5 face machining in a single setup



Ecogrind SX⁵ LiMo

- Ideal technology for micro tools
- For manufacturing and resharping of carbide tools of diameter ranging from 0.5 to 12m

Expanding footprint in China



Ecogrind RX5 Neo

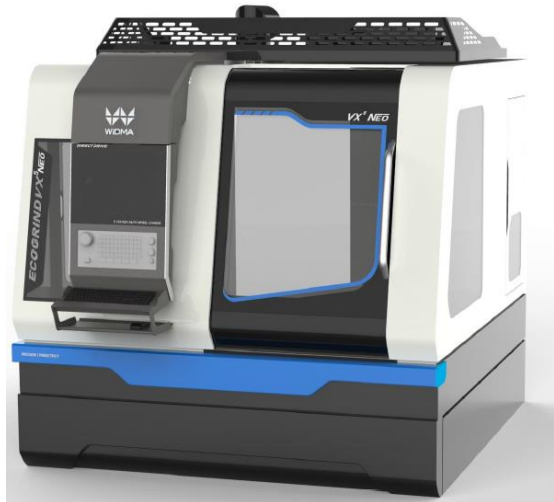

Ecogrind VX5 Neo

**Machine
Installation**



Export to China



The New WIDMA brand identity

Translating the strong brand identity of WIDMA into tangibles



VU Series
Multi-tasking Turn Mill Centres

Versatile possibilities
Consistent accuracy

The VU Series multi-tasking turn mill centres with 5 axis capability enable component manufacturing with very high accuracy.

The B axis tilting head spindle enables machining on five faces in a single set up.

The VU Series is ideal for manufacturing complex components like turbine offset valve, pumps, graphite block.

VU Series – versatile, value for money manufacturing.

WIDMA
Machining Solutions Group
10000, 100th Street, Suite 1000
Edmonton, Alberta T6E 4E1, Canada
www.widma.com

PRESS RELEASE
FOR IMMEDIATE RELEASE
DATE: March 22, 2022

CONTACT: SWASTIKA MUKHERJEE
EMAIL: swastika@machineering.com

GEAR UP TO GRIND THE NEXT GENERATION HOBS AND SHAPER CUTTERS
HOBGRIND H5200
CNC hob and shaper cutter grinding machine

BENGALURU, Mar. 22, 2022 – WIDMA® has launched Hobgrind H5200, a new CNC machine dedicated to regrounding high precision hobs and shaper cutters of both steel and hybrid type. This machine is ideal for gear manufacturers, especially those wanting to perform regrounding operations offshore with maximum quality control, savings benefiting from reduced inventory levels and lead time.

The new machine is built with thermal stability to ensure that the hobs are ground to the highest precision levels. Effect of distribution of stress and compact hobs, per a robust structure. Weighing near 4.0 tons, Hobgrind H5200 has a cast-iron base having special vibration dampening characteristics that enables smooth performance and accuracy.

Key features of Hobgrind H5200 include:

- The work head (z-axis) has a direct drive through a high torque motor coupled with a high-resolution encoder for precise indexing of the component.
- The table has hobs hobs on mandrels between center is pneumatically actuated for quick change while ensuring rigidity.
- An ultra-compact wheel dresser allows dressing of grinding wheel on the machine. This feature ensures high degree of accuracy on the reground hobs for the hobs with high helix angles.
- WIDMA's CNC system ensures excellent performance.
- A special menu of soft software called e-Grind is developed for hob and shaper cutter regrinding, having an operator friendly interface.



WIDMA
Machines | Fixtures | Tooling

WIDMA
Software

- Compact Tool Loader
- Robot Tool Loader

WIDMA
Ecogrind VXC Neo
CNC Tool and Cutter Grinding Machines



Customer events for improving outreach

Face to face events after a gap of two years



Code of Conduct training for relevant stakeholders

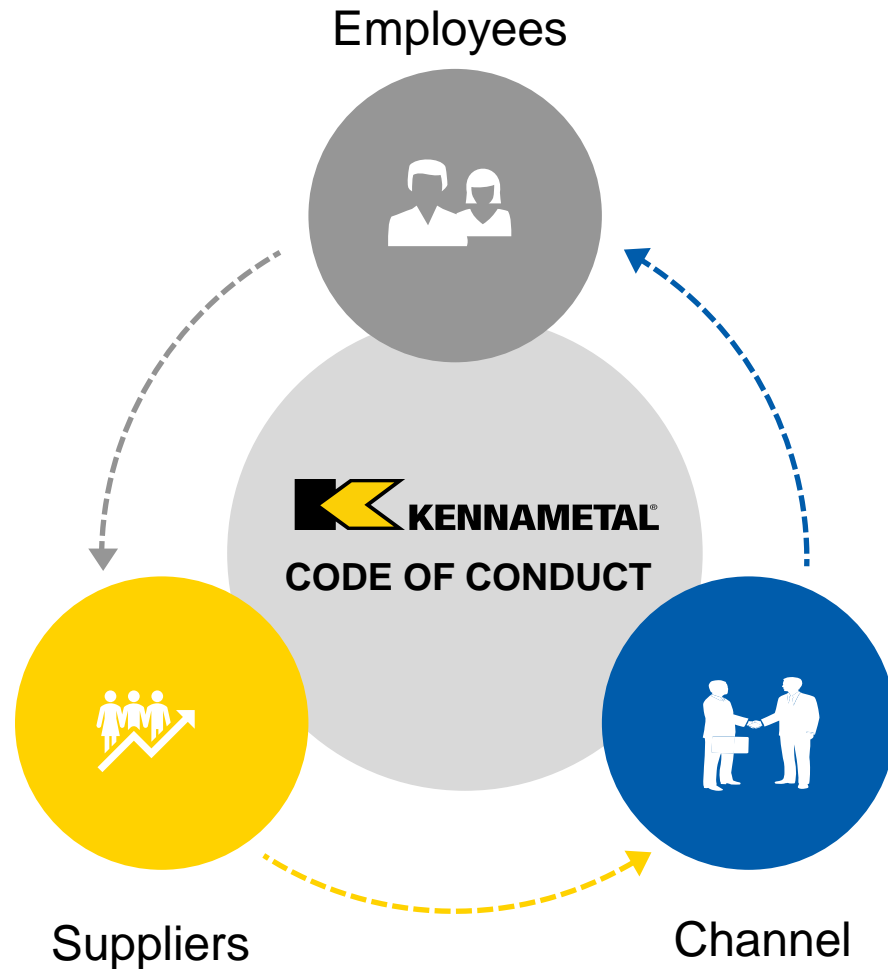

Kennametal accelerated its efforts to reinforce ethics, integrity while touching upon the essentials of ESG with all its suppliers, distributors, job contractors both physically and virtually. Over 400 suppliers and 200 distributors were covered.



Energy Conservation initiatives to minimize environmental impact

Sourcing 67.3% of required energy from solar

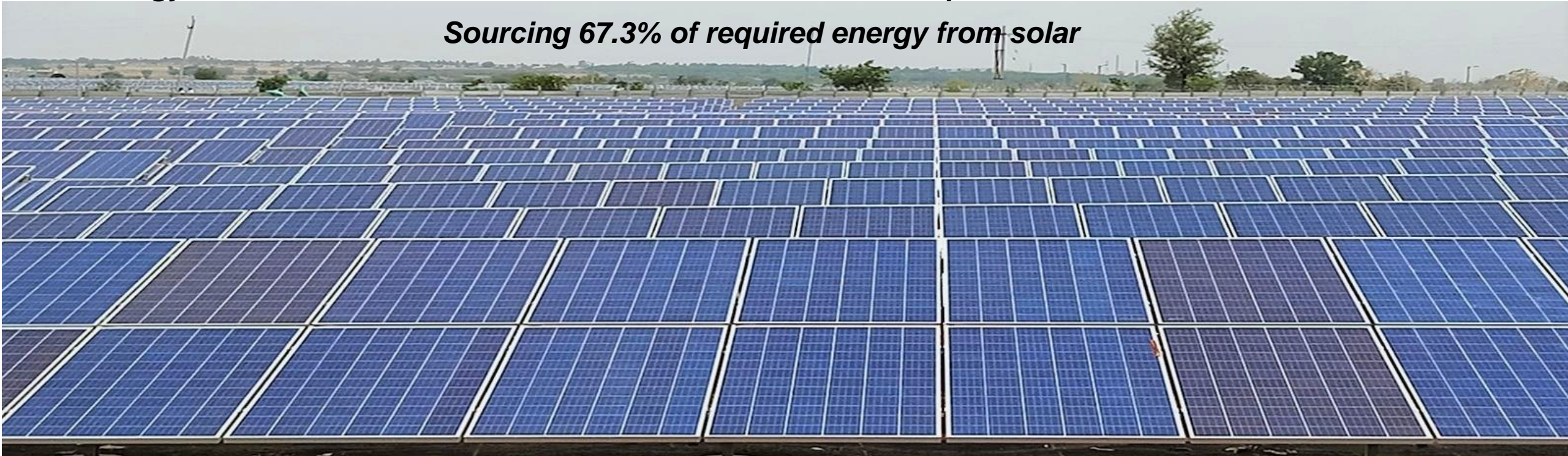

Water Conservation

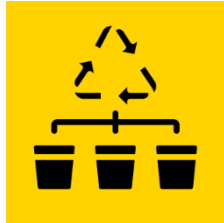

Waste Management



Reconditioning and Recycling

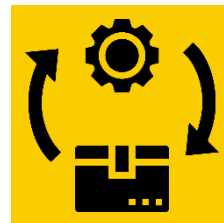

Product Stewardship

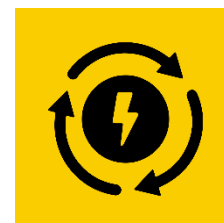

Energy Conservation



Renewable Energy Adoption

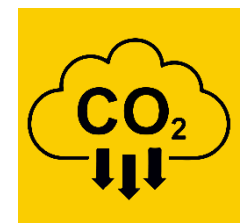

Emissions Control

Advancing Diversity and Inclusion



AWARENESS



ACQUISITION



DEVELOPMENT



COMMUNITY

- Awareness campaigns
- Sensitization trainings on D&I, Unconscious Bias
- Participation in professional, external networks– CII India Women Network

- Amplifying women success stories through social media
- Celebrating Diversity – Invite as speakers, celebrate March as Diversity month
- Promoting STEM education

Enhancing employee engagement

Employee communications



KRONICLE

INTERNAL NEWSLETTER | ISSUE 01 | April-June 2021

“

Hi! We are thrilled to present to you Kronicle - KIL's first-ever internal newsletter. With this quarterly release, we aim to promote employee engagement, communication, and collaboration by highlighting notable achievements spanning across the organization, community outreach initiatives, interesting events and our commitment to cultural beliefs and diversity and inclusion. Hope you enjoy this issue.

- KIL Marketing Team

”

What's Inside

KONNECT | MD's Message • P. 2
KARE | Community Outreach • P. 4
KAPTURE | Events/Happenings • P. 6

KUSTOMER | Business Growth • P. 3
KUDDOS | Recognition • P. 5

© Copyright Kennametal. All rights reserved with Kennametal India Limited.

KARE

COVID RELIEF EFFORTS

We have been doing our part to help the community during the COVID-19 pandemic. From donating much needed PPE kits to frontline workers and medical equipment to local hospitals, to contributing to the Government relief fund - we're committed to helping our community through this challenging time. Check out page 6 for more updates on COVID awareness events conducted at KIL.

INDIA LITERACY PROJECT

We have partnered with the India Literacy Project to help fund "smart" classrooms in schools for underprivileged children. From computer and science labs to libraries, the project is giving nearly 2,500 local students access to the critical educational infrastructure needed to build skills for the future.

SPARSHA TRUST

The Sparsha Trust is a non-profit organization focused on promoting equitable education and holistic development of underprivileged children, and organizes several interactive events revolving around these topics. In partnership with the Trust, our colleagues, Mahima Kulkarni and Hema Mahajan conducted a session on developing interpersonal skills, where they shared real-life experiences focused on teamwork and communication.

KATALYST

Kennametal India has partnered with Katalyst, an NGO that supports girls from low-income facilities across India by educating, mentoring, and providing internship opportunities to enable them to gain a level playing field in their professional education and the corporate world, going forward. In the last decade, Katalyst has impacted the lives of 500 girls and through this NGO, KIL is funding the engineering studies of 20 girls.

4 Kronicle | Issue 01 | April-June 2021
© Copyright Kennametal. All rights reserved with Kennametal India Limited.

Annual Awards Event



Making an impact in the community we live

URBAN AFFORESTATION PROJECT

Initiative inaugurated by Dr. Shanth A. Thimmaiah, Chairman, Karnataka State Pollution Control Board



10000

tree saplings planted through the Miyawaki method with the help of United Way India's on ground implementation partner, SayTrees.

2 Years

SayTrees, with the help of corporate volunteers from Kennametal will take care of these saplings so that they can develop into a natural forest cover,

Ground Water Table

rise in the vicinity owing to soil and moisture conservation

ONE BILLION DROPS PROJECT AT J.P. PARK IN MATHIKERE, BENGALURU

Initiative inaugurated by Shri N. Muniratna, Hon'ble Horticulture, Planning and Statistics Minister for the State of Karnataka



86

Percolation pits built over 90 days to decrease rainwater wastage and improve availability in the surrounding residential area

6 meter

Increase in the water table around the park

Securing Water Availability

Reduction in dependence on other water sources, while generating water supply for gardening and watering the park

Stay the course on growth, people and sustainability



01

ACCELERATING GROWTH

- Commercial Excellence
- Drive operational efficiency to mitigate commodity price volatility
- Continue to diversify customer base
- Focus on innovation to enhance customer value
- Continue brand building efforts



02

PEOPLE

- Focus on talent retention
- Continue employee engagement
- Drive People Development initiatives
- Continue striding the L&D curve



03

ESG

- Sustain benchmarked safety standards
- Compliance Management through process improvement
- Risk Management
- Diversity and Inclusion
- Corporate Social Responsibility

Diverse and experienced team steering the growth for KIL



Vijaykrishnan Venkatesan
Managing Director



Prashant Shetty
Director Sales – Metal Cutting



Swamy M.T.
Director Sales - Infrastructure



Rajashekar Venkat
Director APAC - Machining Solutions Group



Swastika Mukherjee
General Manager – Strategic Marketing



M.N. Bhaskara Rao
Vice President - Manufacturing



K.V. Suresh Reddy
Chief Financial Officer



Naveen Chandra
General Manager – Legal & Company Secretary



Manu Kidave
General Manager – Human Resources

