



PPAP Automotive Limited

B-206A ■ Sector-81 ■ Phase-II ■ Noida 201305 ■ Uttar Pradesh ■ India
☎ +91-120-4093901 ✉ info@ppapco.com 🌐 www.ppapco.in

19th May, 2023

The Listing Department
BSE Limited
Phiroze Jeejeebhoy Towers,
Dalal Street,
Mumbai – 400001
Symbol: 532934

The Listing Department
The National Stock Exchange of India Limited
Exchange Plaza,
Bandra Kurla Complex,
Bandra (E), Mumbai - 400051
Symbol: PPAP

Subject: Analysts and Investors Presentation pursuant to Regulation 30 of the Securities and Exchange Board of India (Listing Obligations and Disclosure Requirements) Regulations, 2015.

Dear Sir,

Pursuant to Regulation 30 of the Securities and Exchange Board of India (Listing Obligations and Disclosure Requirements) Regulations, 2015, please find enclosed the Analysts and Investors presentation on the financial results (standalone and consolidated) of the Company for the quarter and financial year ended 31st March, 2023.

This is for your information and record.

Thanking you,
Yours faithfully,
For **PPAP Automotive Limited**

Pankhuri Agarwal
Company Secretary & Compliance Officer



PPAP Automotive Limited

TAKING CHALLENGES, TOGETHER

Investor presentation – May 2023



Safe Harbour



This presentation and the accompanying slides (the “Presentation”), which have been prepared by **PPAP Automotive Limited (the “Company”)**, have been prepared solely for information purposes and do not constitute any offer, recommendation or invitation to purchase or subscribe for any securities, and shall not form the basis or be relied on in connection with any contract or binding commitment whatsoever. No offering of securities of the Company will be made except by means of a statutory offering document containing detailed information about the Company.

This Presentation has been prepared by the Company based on information and data which the Company considers reliable, but the Company makes no representation or warranty, express or implied, whatsoever, and no reliance shall be placed on, the truth, accuracy, completeness, fairness and reasonableness of the contents of this Presentation. This Presentation may not be all inclusive and may not contain all of the information that you may consider material. Any liability in respect of the contents of, or any omission from, this Presentation is expressly excluded.

This presentation contains certain forward-looking statements concerning the Company’s future business prospects and business profitability, which are subject to a number of risks and uncertainties and the actual results could materially differ from those in such forward-looking statements. The risks and uncertainties relating to these statements include, but are not limited to, risks and uncertainties regarding fluctuations in earnings, our ability to manage growth, competition (both domestic and international), economic growth in India and abroad, ability to attract and retain highly skilled professionals, time and cost over runs on contracts, our ability to manage our international operations, government policies and actions regulations, interest and other fiscal costs generally prevailing in the economy. The Company does not undertake to make any announcement in case any of these forward-looking statements become materially incorrect in future or update any forward-looking statements made from time to time by or on behalf of the Company.



Financial Highlights



Key Highlights



FY23 Performance

- The standalone revenue grew by 20.4% to Rs 492.3 crores against corresponding period last year on account of supplying parts to newer models across OEMs
- The company witnessed an EBITDA growth of 16.7% to Rs 45.6 crores on a YoY basis due to improved capacity utilisation. EBITDA margins stood at 9.3% against 9.5% during same period last year
- The Parts contributed 93.4% of the total revenues while Tools & Others contributed 6.6% of the revenues
- The capacity utilization stood at 76%
- During the quarter, PPAP had begun supplying parts to newly launched vehicles of marquee OEMs such as:
 - Hyundai's **New Verna**
 - Tata's **Safari**
 - Honda's **City MMC**
- The Company has been awarded for under various categories such as:
 - **Manufacturing Excellence** by MSIL
 - **Overall Performance** by MSIL
 - **Target Accomplished in Quality** by Honda Motors
 - **Best Cost Performance Award** by Toyota
 - **Gold Award in QCC** by Toyota
 - **Best Kaizen Award** in Delivery by Toyota
 - **Appreciation Award** from Hyundai

Management Commentary



Commenting on the results and performance for Q4 & FY23, Mr. Ajay Kumar Jain, Chairman & MD of PPAP Automotive Ltd said:

“FY23 is marked as the first normalized year post Covid, witnessing a significant rebound in the overall economy. We are delighted to report a revenue growth of 20.4% on a YoY basis to Rs 492.3 crore in FY23 as against Rs 409.1 crore in FY22. PAT grew by 48.4% to Rs 6.8 crore in FY23 as compared to Rs 4.6 crore in FY22.

On a quarterly basis, revenues increased by 10.2% to Rs 127.1 crore in Q4FY23 as compared to Rs 115.4 crore during Q4FY22. However, EBITDA declined by 7.5% over last year due to rise in employee costs owing to increase in manpower as part of ongoing reorganization activity.

We anticipate FY24 to be a year of reckoning due to multiple tailwinds in the automobile industry as well as the positive additions from new initiatives started by the company. The increase in capacity utilization coupled with the tariff revision from the customers will put the company on a sound footing to grow in the coming years.

The Board of Directors has decided to declare a final dividend of Rs 0.5 to reward the shareholders which leads to a cumulative dividend of Rs 1.5 for FY23”

Key Highlights - Standalone

Yearly Performance

Revenue

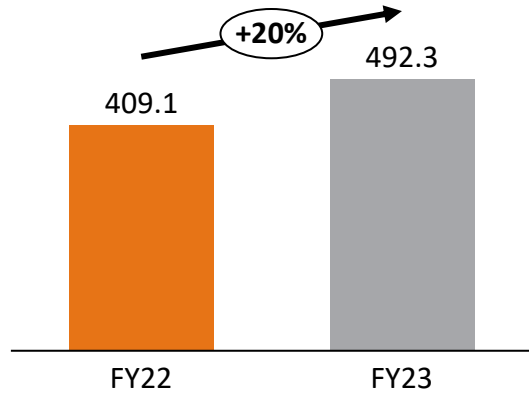

EBITDA

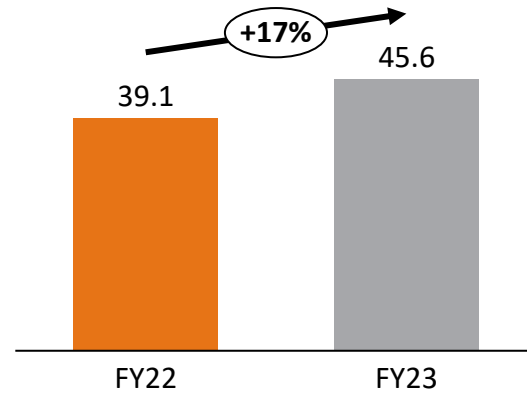

PAT

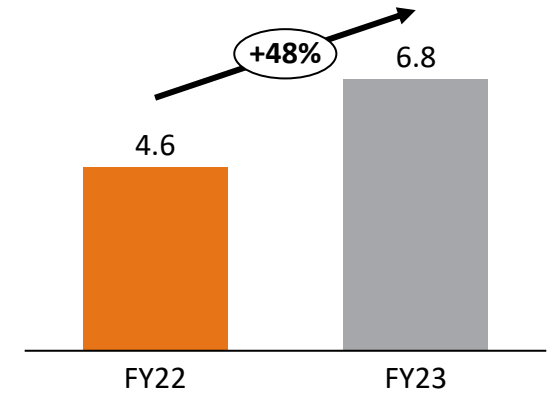

Quarterly Performance

Revenue

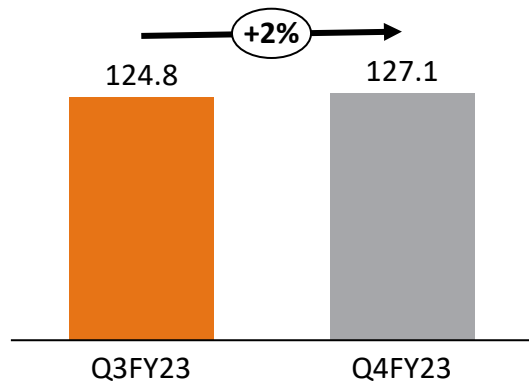

EBITDA

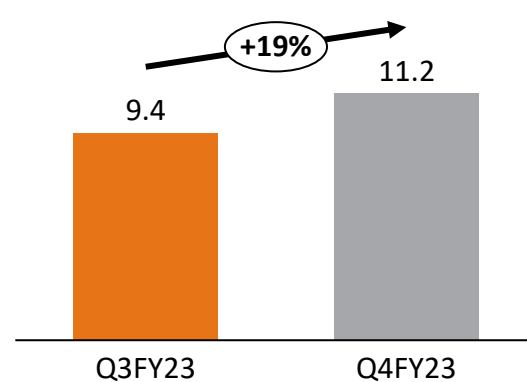

PAT

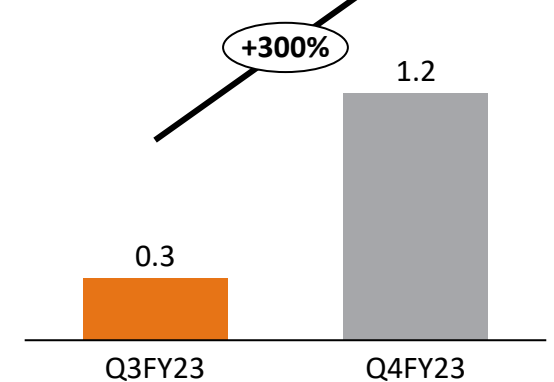

INR Cr



Segmental Breakup



FY22

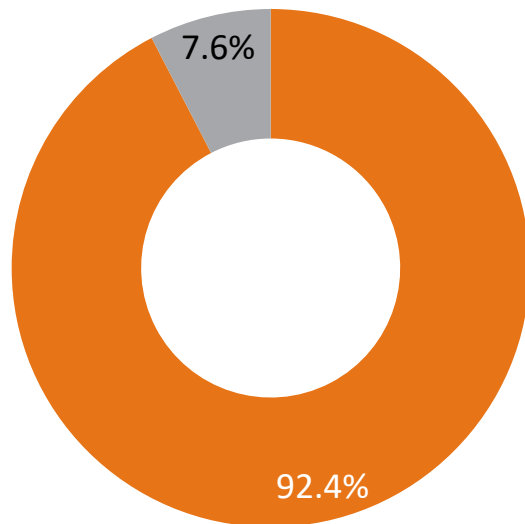

Q4FY22

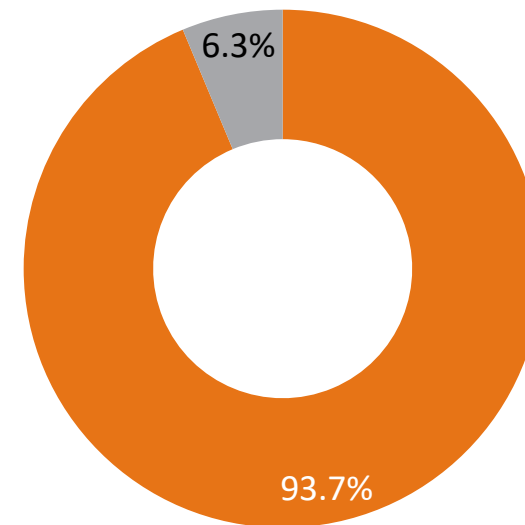

FY23

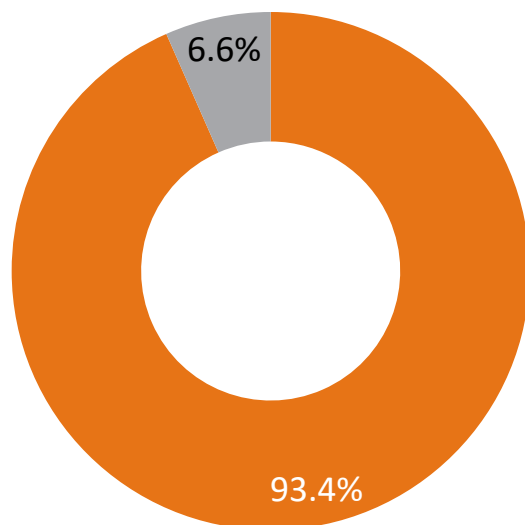

Q4FY23

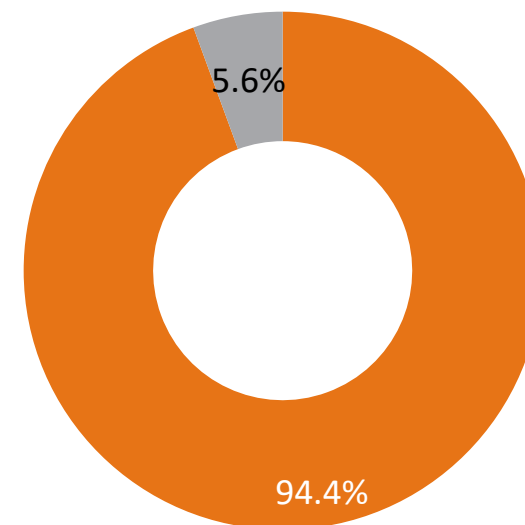

Parts Tools & Others



Standalone P&L – Q4 & FY23



Particulars (INR Cr)	Q4 FY23	Q4 FY22	Y-o-Y (%)	Q3 FY23	Q-o-Q (%)	FY23	FY22	Y-o-Y (%)
Revenue from operations	127.1	115.4	10.2%	124.8	1.9%	492.3	409.1	20.4%
COGS	77.0	70.0		78.0		300.8	247.1	
Gross Profit	50.1	45.4	10.3%	46.8	7.0%	191.5	162.0	18.2%
Gross Profit Margin	39.4%	39.3%		37.5%		38.9%	39.6%	
Employee Expenses	20.9	17.7		20.4		79.0	69.6	
Other Expenses	18.0	15.6		17.0		66.9	53.3	
EBITDA	11.2	12.1	-7.5%	9.4	18.9%	45.6	39.0	16.7%
EBITDA Margin	8.8%	10.5%		7.5%		9.3%	9.5%	
Other Income	1.1	0.7		0.8		3.3	2.0	
Depreciation	7.7	7.1		7.3		29.5	29.0	
Finance Cost	3.0	1.8		2.6		10.3	6.0	
Profit before Tax	1.5	3.9		0.3		9.0	6.1	47.5%
Tax expenses	0.3	1.0		0.1		2.2	1.5	
Profit for the year	1.2	2.9	-58.7%	0.3	359.9%	6.8	4.6	48.4%
PAT Margins	0.9%	2.5%		0.2%		1.4%	1.1%	
EPS	0.86	2.08		0.19		4.86	3.28	

Standalone Balance Sheet



Liabilities (INR Cr)	Mar-23	Mar-22
Equity		
Equity Share capital	14.0	14.0
Other Equity	302.5	298.8
Non Controlling Interest	0.0	0.0
Total Equity	316.5	312.8
Financial liabilities		
(i) Borrowings	67.2	72.4
(i) Lease liabilities	0.3	0.7
(ii) Other Financial liabilities	0.2	0.2
Provisions	5.8	6.3
Deferred tax liabilities (Net)	7.9	7.1
Total Non Current Liabilities	81.3	86.6
Financial liabilities		
(i) Borrowings	55.3	19.4
(ii) Trade Payables	62.2	46.9
(iii) Other financial liabilities	5.6	5.8
(iv) Lease liabilities	0.5	0.5
Provisions	1.0	0.8
Other current liabilities	19.6	17.5
Current tax liabilities (Net)	0.0	0.0
Total Current Liabilities	144.2	90.9
Total Equity and Liabilities	542.0	490.3

Assets (INR Cr)	Mar-23	Mar-22
Non Current Assets		
Property, Plant and Equipment	292.6	261.4
Capital work-in-progress	8.9	20.8
Other Intangible Asset	0.9	1.1
Investment Property	7.5	8.8
Intangible assets Under Development	1.7	0.0
Right of Use Asset	0.8	1.1
Financial Assets		
(i) Investments	65.0	63.0
(ii) Loans	0.0	0.0
(iii) Other financial assets	2.4	3.7
Deferred Tax Assets (net)	0.0	0.0
Other non-current assets	9.4	10.3
Total Non Current Assets	389.3	370.2
Current Assets		
Inventories	58.1	42.9
Financial Assets		
Investments	4.5	2.7
(i) Trade receivables	61.9	52.2
(ii) Cash and cash equivalents	0.4	0.2
(iii) Other bank balances	0.1	0.1
(iv) Loans	14.8	7.5
(v) Other financial assets	1.8	1.8
Current Tax Assets(Net)	1.1	1.2
Other current assets	10.0	11.5
Total Current Assets	152.7	120.1
Total Assets	542.0	490.3



Standalone Cash Flow



Particulars (INR Cr)	Mar-23	Mar-22
Net Profit Before Tax	9.0	6.1
Adjustments for: Non Cash Items / Other Investment or Financial Items	36.5	32.5
Operating profit before working capital changes	45.5	38.7
Changes in working capital	-3.9	5.2
Cash generated from Operations	41.6	43.9
Direct taxes paid (net of refund)	-2.1	-3.4
Net Cash from Operating Activities	39.6	40.5
Net Cash from Investing Activities	-49.9	-70.2
Net Cash from Financing Activities	10.5	29.0
Net Increase in Cash and Cash equivalents	0.2	-0.8
Add: Cash & Cash equivalents at the beginning of the period	0.2	1.0
Cash & Cash equivalents at the end of the period	0.4	0.2



Consolidated P&L – Q4 & FY23



Particulars (INR Cr)	Q4 FY23	Q4 FY22	Y-o-Y (%)	Q3 FY23	Q-o-Q (%)	FY23	FY22	Y-o-Y (%)
Revenue from operations	132.3	122.6	7.9%	127.1	4.1%	511.1	421.9	21.1%
COGS	82.3	75.5		78.8		313.6	255.8	
Gross Profit	49.9	47.1	6.0%	48.3	3.4%	197.5	166.1	18.9%
Gross Profit Margin	37.8%	38.4%		38.0%		38.6%	39.4%	
Employee Expenses	21.9	18.8		21.4		82.9	72.2	
Other Expenses	19.1	16.2		17.9		70.6	55.2	
EBITDA	8.9	12.1	-26.4%	9.0	-1.4%	43.9	38.6	13.9%
EBITDA Margin	6.7%	9.9%		7.1%		8.6%	9.1%	
Other Income	0.5	0.3		0.1		1.4	1.0	
Depreciation	8.1	7.3		7.7		31.1	29.5	
Finance Cost	3.4	2.0		2.9		11.7	6.5	
Profit before Tax	-2.6	1.7		-4.1		-5.1	0.1	
Tax expenses	-0.3	0.8		-0.4		0.8	0.9	
Profit for the year	-2.3	0.9	-	-3.7	-	-5.9	-0.8	-
PAT Margins	-1.7%	0.7%		-2.9%		-1.2%	-0.2%	
EPS	-1.63	0.61		-2.62		-4.25	-0.56	

Consolidated Balance sheet



Liabilities (NR Cr)	Mar-23	Mar-22
Equity		
Equity Share capital	14.0	14.0
Other Equity	280.7	289.9
Non Controlling Interest		0.0
Total Equity	294.7	303.9
Financial liabilities		
(i) Borrowings	79.9	78.9
(ii) Lease liabilities	0.3	0.9
(iii) Other Financial liabilities	0.0	0.1
Provisions	6.0	6.4
Other non current Liability	0.0	0.0
Deferred tax liabilities (Net)	5.1	6.0
Total Non Current Liabilities	91.3	92.2
Financial liabilities		
(i) Borrowings	70.9	29.2
(ii) Trade Payables	63.3	48.6
(iii) Other financial liabilities	6.4	6.4
(iv) Lease liabilities	0.6	0.8
Provisions	1.0	0.9
Other current liabilities	19.8	17.7
Current tax liabilities (Net)	0.0	0.0
Total Current Liabilities	161.9	103.5
Total Equity and Liabilities	548.0	499.5

Assets (NR Cr)	Mar-23	Mar-22
Non Current Assets		
Property, Plant and Equipment	309.7	273.9
Capital work-in-progress	9.0	20.8
Other Intangible Asset	8.3	8.8
Intangible assets Under Development	1.7	0.7
Right of Use Asset	0.9	1.6
Financial Assets		
(i) Investments	37.3	42.9
(ii) Loans		0.0
(iii) Other financial assets	4.6	5.1
Deferred Tax Assets (net)	0.0	0.0
Other non-current assets	10.2	10.3
Total Non Current Assets	381.7	364.2
Current Assets		
Inventories	76.1	56.1
Financial Assets		
Investments	4.5	2.7
(i) Trade receivables	65.1	55.9
(ii) Cash and cash equivalents	0.8	0.4
(iii) Other bank balances	0.1	0.1
(iv) Loans	0.1	0.0
(v) Other financial assets	2.1	1.8
Current Tax Assets(Net)	1.1	1.2
Other current assets	16.4	17.2
Total Current Assets	166.3	135.4
Total Assets	548.0	499.5

Consolidated Cash Flow



Particulars (INR Cr)	Mar-23	Mar-22
Net Profit Before Tax	-5.1	0.1
Adjustments for: Non Cash Items / Other Investment or Financial Items	49.0	37.7
Operating profit before working capital changes	43.8	37.8
Changes in working capital	3.4	-6.2
Cash generated from Operations	47.3	31.6
Direct taxes paid (net of refund)	2.3	3.6
Net Cash from Operating Activities	44.9	28.0
Net Cash from Investing Activities	-56.2	-70.9
Net Cash from Financing Activities	11.7	42.0
Net Increase in Cash and Cash equivalents	0.4	-0.9
Add: Cash & Cash equivalents at the beginning of the period	0.4	1.3
Cash & Cash equivalents at the end of the period	0.8	0.4



Company Overview

Business – at a Glance



Aftermarket Business

ELDIS Components Distributors Private Limited

- Development and sales of spare parts, accessories for after market
- 100% owned subsidiary of PPAP
- PAN India distribution network for offline sales
- e-commerce network for online sales through own website and e-commerce portals
- Focus on domestic and international market



Automotive Parts Business

PPAP Tokai India Rubber Pvt Ltd



- Core competence in developing Automotive Body Sealing systems and Interior and Exterior Injection molded parts.
- All products are engine agnostic products
- Enhancing per car contribution by adding more products and increasing the customer base in all segments (PV / 2 W / CV / Tier 1)
- Focusing on developing dedicated parts for Electric vehicles
- Global Level development of value-added products through in house design and technology development capabilities



Commercial Tool Business

- Development of Plastic Injection tools up to 1.5m * 1.0m
- Established in 2020 as a separate profit center
- Focus on development of injection mold for Automotive, White Goods, Medical, Electrical and other related Industries
- Global Level facility with Excellence in Tool design and Manufacturing capabilities



Li-ion Battery Business

PPAP Technology Limited

- Development of Li-Ion Battery pack solutions
- 100% owned subsidiary of PPAP
- Focus on Mobility (2 Wheeler and 3 Wheeler) and Storage applications
- Inhouse design and development capabilities and best in class Manufacturing facility



Industrial Product Business

- Extension of core competence of Plastic and Rubber processing to neighboring industries other than Automotive
- Development Application Engineering products
- Focus on various industries – Packaging, White Goods, Household, Construction
- Focus on domestic and international market

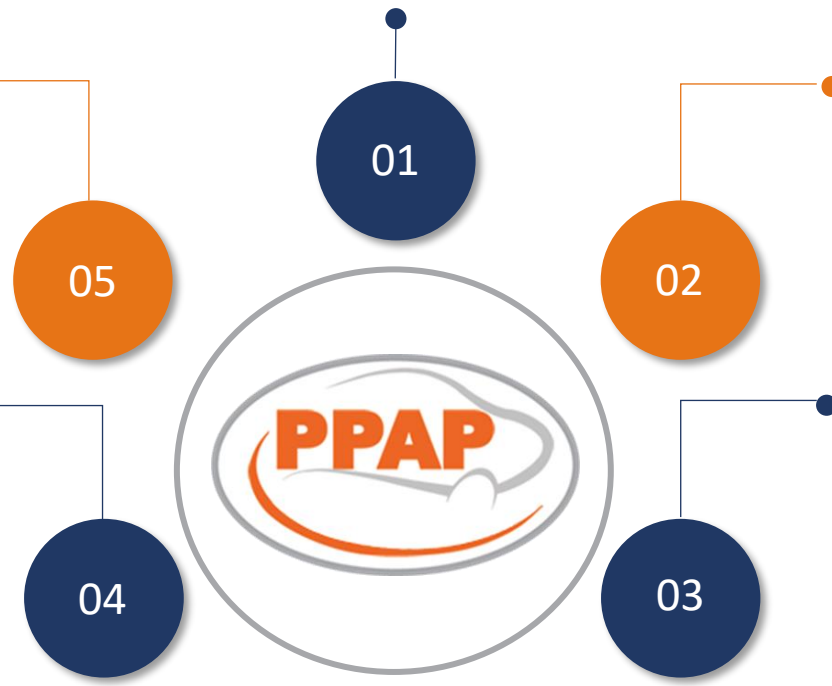

Company Ethos



Vision Statement

To be

our customer's

No. 1 supplier



Mission Statement

To be a global level excellence company,
with an inspiring work culture,
for serving our customers and our society,
by exceeding the expectations,
of all our stakeholders



Our Values

- Trustworthiness
- Mutual Respect
- Creativity
- Co-operation
- Excellence

Journey Towards Excellence...

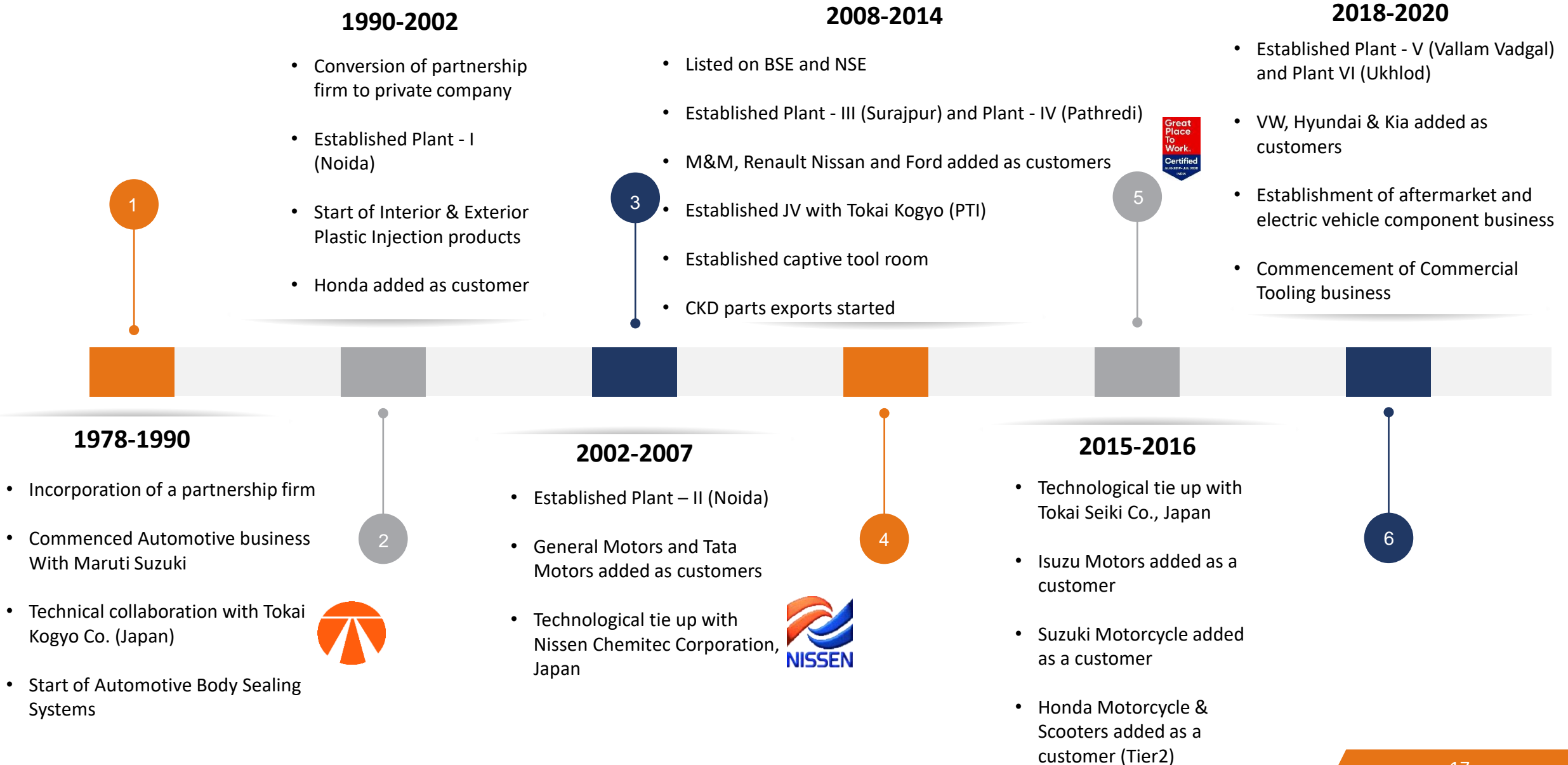

Board of Directors



Ajay Kumar Jain : Chairman & Managing Director

- Bachelor of Commerce from Shri Ram College of Commerce, Delhi University
- Associated with the Company since inception with experience of over 45 years in polymer processing industry and over 30 years in the automotive industry
- President of Toyota Kirloskar Supplier Association



Bhuwan Kumar Chaturvedi : Independent Director

- B.E. (Mech.) from I.I.T. Roorkee and M.B.A. from IIM, Ahmedabad
- Has a rich and diverse top management experience in the field of automobile, auto components, engineering, etc.
- Associated with Tata Motors, Eicher and Hindustan Motors
- President of Tractor Manufacturers Association & Member of CII National Council



Pravin Kumar Gupta : Independent Director

- A Fellow Member of the Institute of Chartered Accountants of India
- Managing Partner of K.S. Gupta Co., Chartered Accountants (Est.: 1955) with over 35 years of experience
- He has in depth knowledge and experience in the field of Corporate Finance, Taxation, Accounts and Audit



Deepak Kumar Sethi : Independent Director

- B.E. (Mech.) from Delhi College of Engineering & M.B.A. from IIM, Ahmedabad
- Work experience of over 40 years primarily in automotive sector. He has worked with Maruti Suzuki for over 38 years
- He was deputed as whole time Director of Suzuki Powertrain India Ltd, and Maruti Suzuki as Executive Director of Supply Chain and Quality Assurance



Celine George : Independent Director

- PGDM in Business Economics from Delhi University, PGDIM from IMI Delhi and Chevening Gurukul Scholar from London School of political science & Economics
- Associated with ONGC, TCS, Cairn Energy, Max healthcare
- She has over 30 years of experience in the areas of Leadership, Business Transformation and HR



Vinay Kumari Jain : Non-Executive Director

- Bachelor of Science from Delhi University
- Founding partner of our Company
- Associated with the business since inception
- Work experience of over three decades. She possess a deep understanding of automotive business



Abhishek Jain : CEO & Managing Director

- Bachelor of Science in Industrial Engineering from Purdue University, USA
- Work experience of over 15 years
- Chairman of North region Honda Suppliers Club
- Coordinator Zone 2 Automotive Component Manufactures Association Northern Region



Operating Locations...

The Company's state of the art manufacturing facilities are strategically located across the PVs automotive hubs in Northern, Southern and Western India

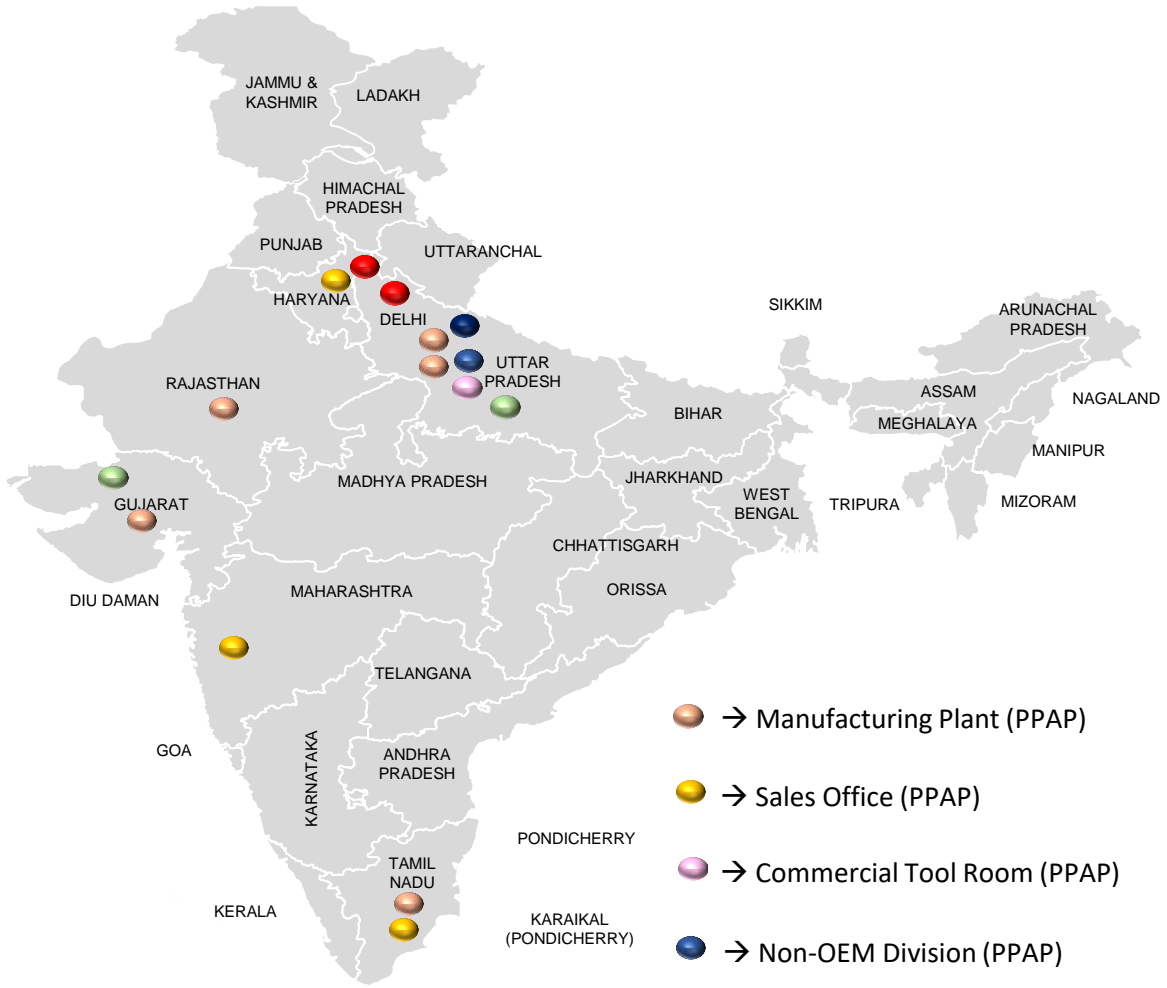

Note – Maps not to scale. All data, information, and maps are provided “as is” without warranty or any representation of accuracy, timeliness or completeness

Manufacturing Facilities...

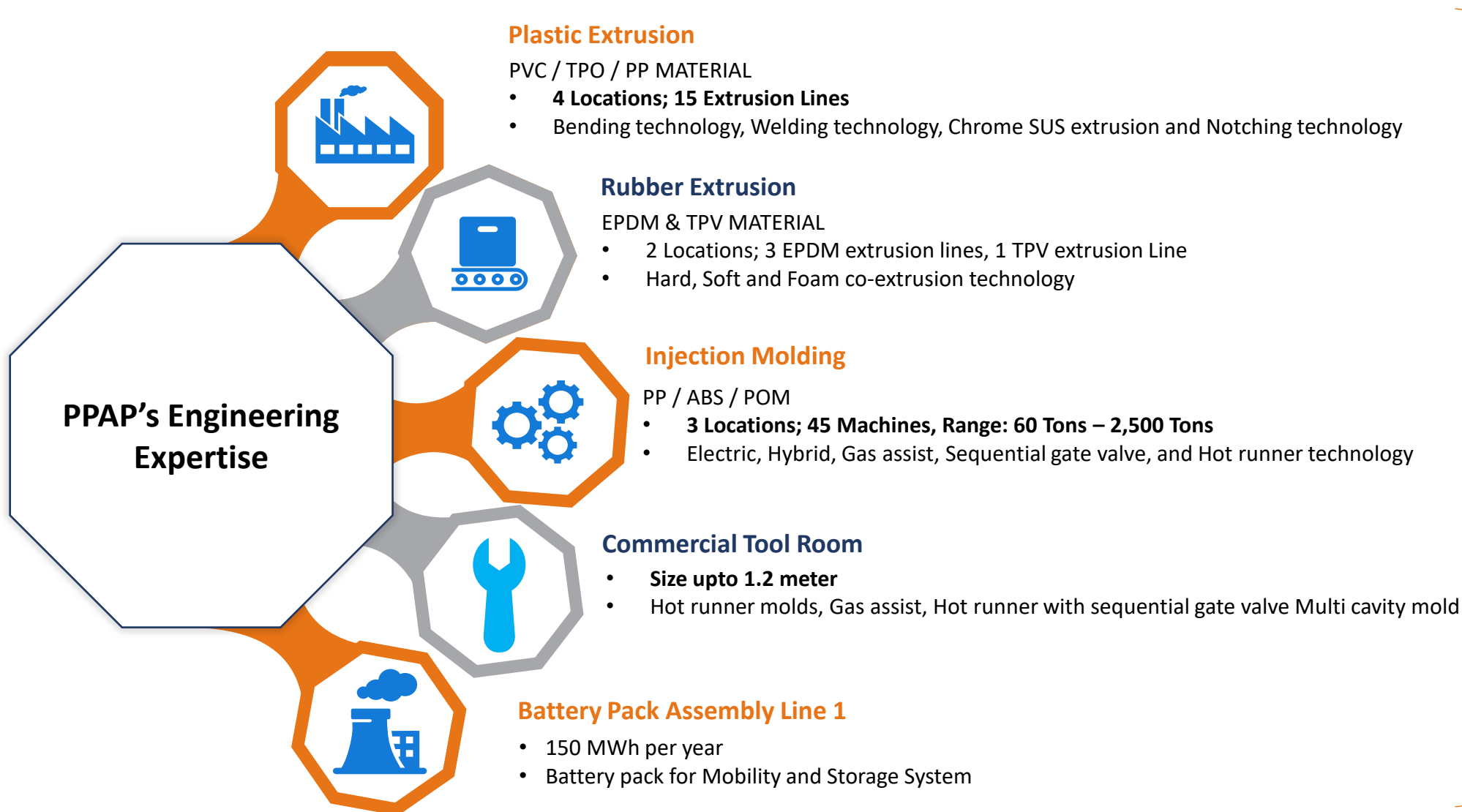

Part & Tool Design
Manufacturing
Tool
Testing & Validation

Passenger Vehicle Products

PPAP offers a diverse range of products that are applicable to both EV and non-EV vehicles

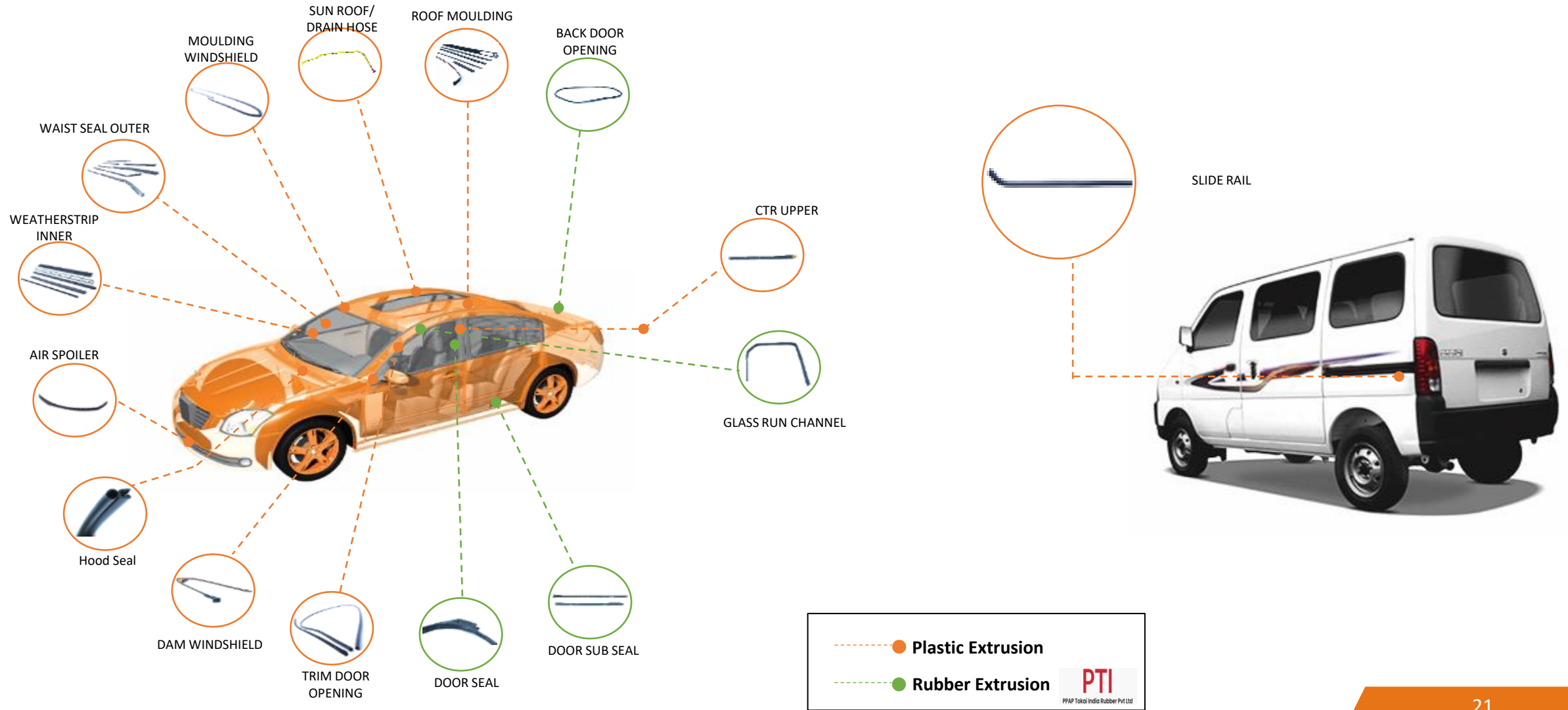

Passenger Vehicle Products

PPAP offers a diverse range of products that are applicable to both EV and non-EV vehicles



Commercial Vehicle Product



--- Injection Moulding



Two Wheeler Products



PPAP offers a diverse range of products that are applicable to both EV and non-EV vehicles



EV Components – High Growth Market

PPAP intends to manufacture a variety of electric vehicle components in order to meet the growing demand for EVs

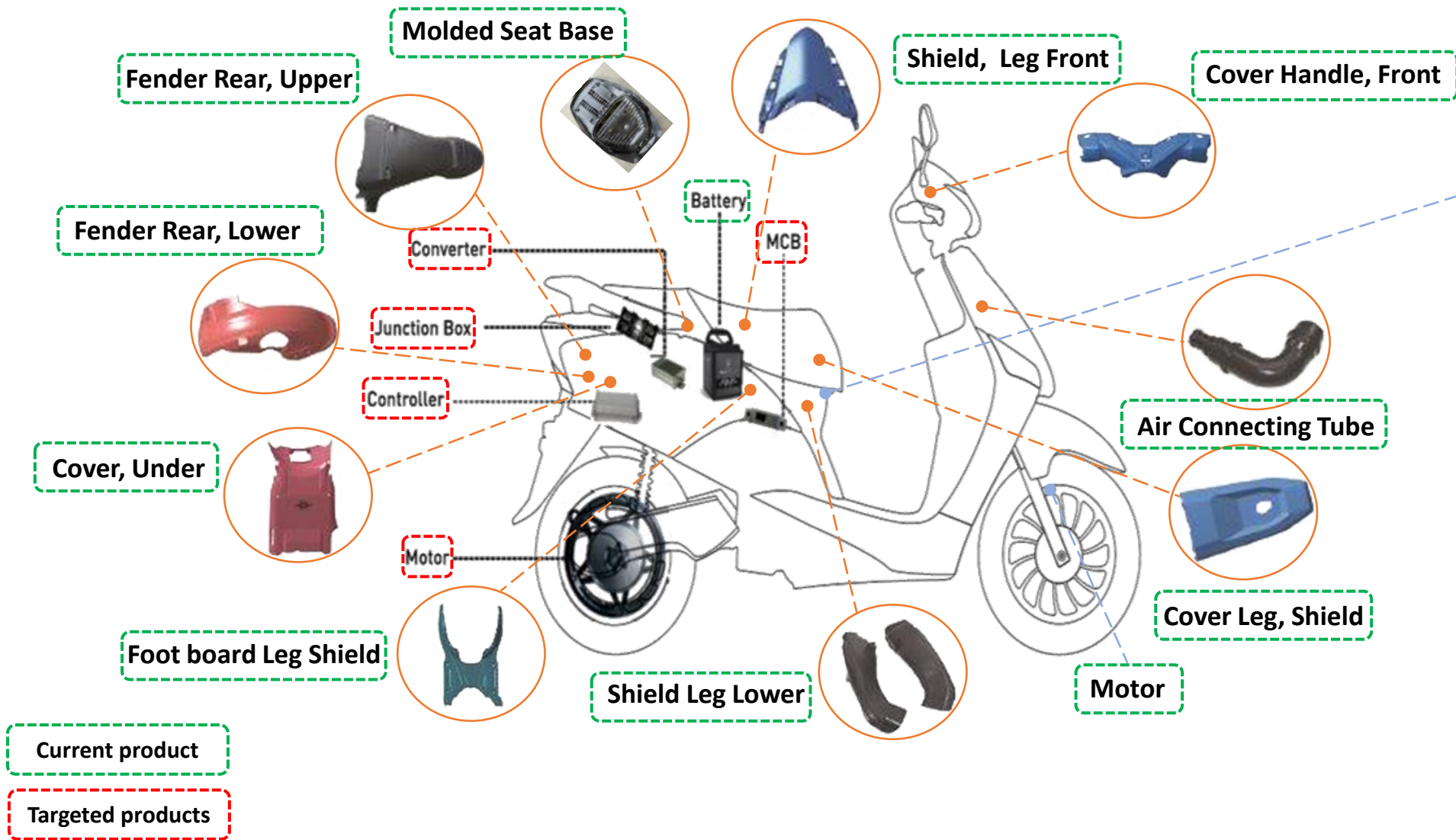

Battery Pack for Electric Vehicles



Diversified Product Mix



Plastic Injection Tools

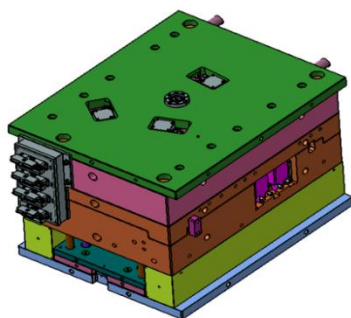
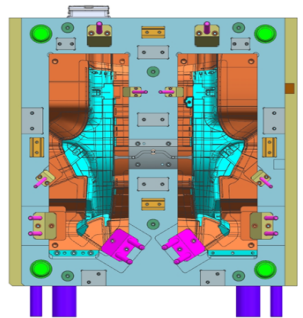
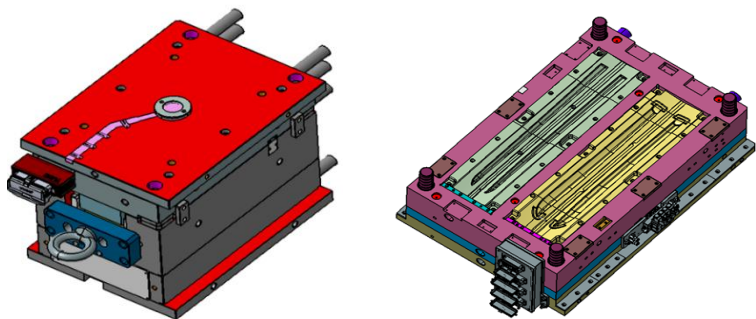

Tonnage – Upto 850 Tons
Size – 1500 (L) x 1000 (W) x 850 (H)
Mould Weight – Upto 8 Ton



Battery Pack for Back up power



Application :



Solar Street Light



Mobile Towers



UPS

The battery packs are used in multiple products for providing back up power



Pail Containers



Containers for storing fertilizers, paints and lubricants

Aftermarket – A Large Opportunity

- The Company has ventured into development of parts and accessories for aftermarket.
- The products are sold through the wholly owned subsidiary Elpis Components Distributors Private Limited
- Currently, this segment contributes 3% of revenue and is expected to increase to 10% by FY24

Distribution Network

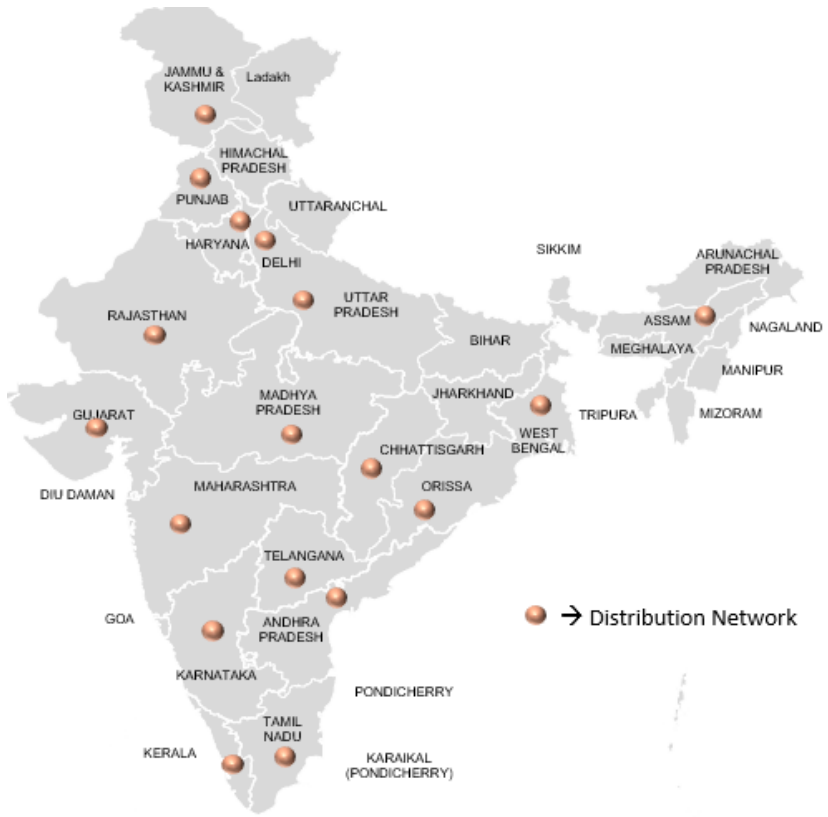

Car Accessories



- Interior accessories – Phone holder, Rear tray, charger sockets, Perfumes
- Range of cleaning products

Shopelpis.com

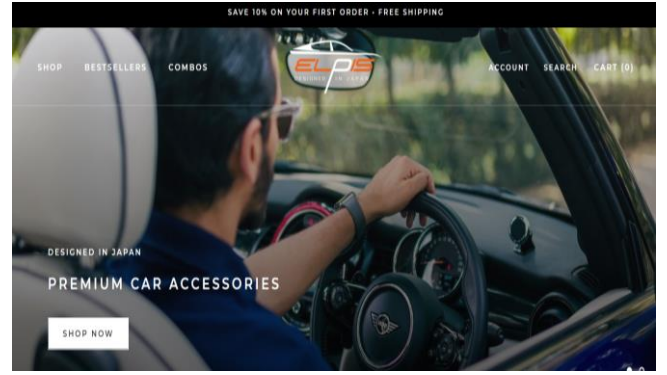

Amazon.com

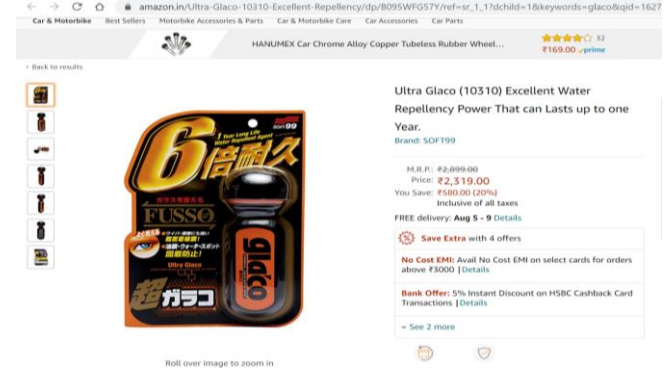



Esteemed Clientele

Passenger Vehicle



Two Wheeler



Battery Packs – EV Two Wheelers



Battery Packs – Storage System



Commercial Vehicle



Pail Containers



Tooling





Growth Roadmap – Explore, Expand & Excel



Strengthen and grow Automotive Parts business

- Development of value-added parts that will command higher prices and contribute to higher margins
- Increase per car value for existing customers and continue to add new customers
- Future ready processes with manufacturing excellence and digitization

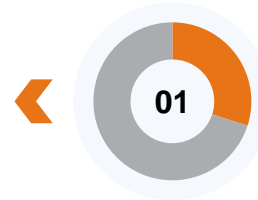

Unlocking hidden potential for tooling business

- Develop plastic injection tooling business as a profit center
- Explore opportunities in Automotive, White Goods and Electrical segments

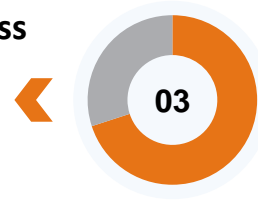

Develop product portfolio for Electric Vehicles

- Develop customers making Electric Vehicles for the existing product range (Body Sealing Products and Interior and Exterior Injection Products)
- Develop special products focusing on 2-Wheeler and 3-Wheeler requirements (like Battery Pack, motor controllers etc)

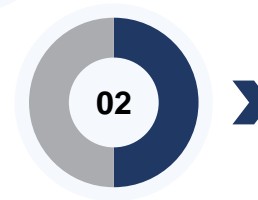
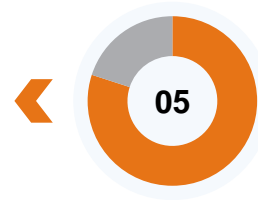

Market Place Enhancement

- Explore new market avenues for existing products
- Develop new products focusing on after market
- Develop after market customers through distribution partners and direct online sales channels

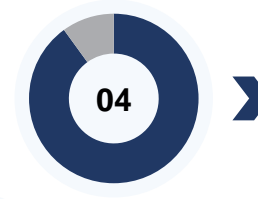

Diversification in the neighbouring industries

- Explore opportunities to promote core competence of the company in neighboring industries (Extrusion and Injection Molding)
- Develop value added products for various sectors like Packaging, Medical, Railways, Construction etc...

Why Trust PPAP... at a glance

01

Continuous improvement of operational efficiency

- Cost sensitive working culture
- International benchmarking
- Implementation of TPS & TBP (Toyota Production System & Toyota Business Practices)
- Focus on Human Development – Development of Mind, Body and Intellect
- Optimize use of resources

02

Portfolio approach to margin-rich blended product mix

- The Company has a portfolio approach to building a healthy mix of premium-priced value added products and budget-priced mould parts
- The Company's product mix is carefully blended to ensure PPAP is able to make healthy overall margins at a portfolio level

03

Organic growth complemented by adding new clients and geographies

- The Company presently caters to marquee OEMs such as Maruti Suzuki, Honda, Hyundai, Tata etc.
- Continuously explore and add new customers, while consistently expanding its per car share within the existing OEMs organically
- Developing value added products through inhouse Research and Technical Development capabilities
- Operations closer to the customer

04

Sound financials giving headroom to fund its growth

- A strong financial discipline coupled with the ability to generate regular free cash flows, allows PPAP to adequately fund its growth organically
- Low debt ratios
- Focus on improvement of return ratios
- Focus on "Every Paisa Counts"

ESG Initiatives

Environment

- PPAP is dedicated to reducing the environmental footprint through an efficient and process-oriented approach
- PPAP has been taking initiatives for reducing energy consumption and GHG emissions by installing rooftop solar and introducing various energy efficient technology
- Focus on waste management and water resource management



Social

- PPAP is committed to constantly improve employee development in the skill & talent management cycle from employment, growth and retention through training & user-friendly technology
- Promotes gender diversity and has hired women at shop floor as well as Corporate office
- CSR activities done through Vinay & Ajay Jain Foundation in the field of Environment, education and healthcare



Robust Governance Framework

Governance

- PPAPs philosophy for governance aims to achieve the highest standards of corporate governance, accountability, sustainability and compliance of all the laws in the letter and spirit
- PPAP strongly believes that effective and good corporate governance practices build a strong foundation of trust and confidence, attracting human capital, leading to sustainable and superior performance
- There are various committees that play a crucial role in the governance structure of the Company and have been constituted to deal with specific areas and activities which concern the Company
- PPAP has established a risk management framework that enables regular and active monitoring of business activities to identify, assess and mitigate potential internal or external risks
- The Company has a code of conduct for all employees, including the Board and senior management personnel. All members of the Board and Senior Management personnel have affirmed compliance with the said code of conduct





**Historical
Financials**





Standalone P&L



Particulars (INR Cr)	FY23	FY22	FY21	FY20
Revenue from operations	492.3	409.1	321.2	360.0
COGS	300.8	247.1	182.6	195.9
Gross Profit	191.5	162.0	138.5	164.1
Gross Profit Margin	38.9%	39.6%	43.1%	45.6%
Employee Expenses	79.0	69.6	61.2	66.1
Other Expenses	66.9	53.3	43.6	47.3
EBITDA	45.6	39.0	33.7	50.7
EBITDA Margin	9.3%	9.5%	10.5%	14.1%
Other Income	3.3	2.0	2.6	0.7
Depreciation	29.5	29.0	26.3	25.7
Finance Cost	10.3	6.0	3.7	2.6
Profit before Tax	9.0	6.1	6.3	23.1
Tax expenses	2.2	1.5	1.5	3.8
Profit for the year	6.8	4.6	4.8	19.3
PAT Margins	1.4%	1.1%	1.5%	5.3%
EPS	4.9	3.3	3.5	13.8

Standalone Balance sheet



Liabilities (INR Cr)	Mar-23	Mar-22	Mar-21	Mar-20
Equity				
Equity Share capital	14.0	14.0	14.0	14.0
Other Equity	302.5	298.8	295.8	290.2
Non Controlling Interest	0.0	0.0	0.0	0.0
Total Equity	316.5	312.8	309.8	304.2
Financial liabilities				
(i) Borrowings	67.2	72.4	42.3	12.0
(ii) Other Financial liabilities	0.2	0.2	0.0	0.0
Provisions	5.8	6.3	7.3	9.5
Other non current Liability	0.3	0.0	0.0	0.0
Deferred tax liabilities (Net)	7.9	7.1	7.0	7.0
Total Non Current Liabilities	81.3	86.6	56.6	28.5
Financial liabilities				
(i) Borrowings	55.3	19.4	7.3	9.9
(ii) Trade Payables	62.2	46.9	47.8	41.6
(iii) Other financial liabilities	5.6	5.8	7.7	4.2
(iv) Lease liabilities	0.5	0.5	0.0	1.0
Provisions	1.0	0.8	0.8	1.0
Other current liabilities	19.6	17.5	13.5	17.0
Current tax liabilities (Net)	0.0	0.0	0.7	0.2
Total Current Liabilities	144.2	90.9	77.8	73.8
Total Equity and Liabilities	542.0	490.3	444.2	406.5

Assets (INR Cr)	Mar-23	Mar-22	Mar-21	Mar-20
Non Current Assets				
Property, Plant and Equipment	292.6	261.4	230.6	221.7
Capital work-in-progress	8.9	20.8	20.1	7.9
Other Intangible Asset	7.5	8.8	8.9	8.5
Investment Property	0.9	1.1	0.0	0.0
Intangible assets Under Development	1.7	0.0	0.2	0.0
Right of Use Asset	0.8	1.1	0.0	0.0
Financial Assets				
(i) Investments	65.0	63.0	55.3	50.8
(ii) Loans	0.0	0.0	1.8	2.1
(iii) Other financial assets	2.4	3.7	3.0	2.4
Deferred Tax Assets (net)	0.0	0.0	0.0	0.0
Other non-current assets	9.4	10.3	11.0	8.7
Total Non Current Assets	389.3	370.2	330.6	302.0
Current Assets				
Inventories	58.1	42.9	41.8	48.8
Financial Assets				
Investments	4.5	2.7	0.0	0.0
(i) Trade receivables	61.9	52.2	61.9	41.1
(ii) Cash and cash equivalents	0.4	0.2	1.0	2.1
(iii) Other bank balances	0.1	0.1	0.1	2.9
(iv) Loans	14.8	7.5	0.5	0.4
(v) Other financial assets	1.8	1.8	0.5	0.5
Current Tax Assets(Net)	1.1	1.2	0.0	0.0
Other current assets	10.0	11.3	7.6	8.7
Total Current Assets	152.7	119.3	113.6	104.5
Total Assets	542.0	490.3	444.2	406.5



Standalone Cash Flow



Particulars (INR Cr)	Mar-23	Mar-22	Mar-21	Mar-20
Net Profit Before Tax	9.0	6.1	6.3	23.1
Adjustments for: Non Cash Items / Other Investment or Financial Items	36.5	31.5	27.0	27.8
Operating profit before working capital changes	45.5	38.7	33.3	50.9
Changes in working capital	-3.9	5.2	-2.2	-2.5
Cash generated from Operations	41.6	43.9	31.2	48.4
Direct taxes paid (net of refund)	-2.1	-3.4	-1.1	-12.2
Net Cash from Operating Activities	43.4	40.5	30.1	36.2
Net Cash from Investing Activities	-49.9	-70.2	-49.4	-29.2
Net Cash from Financing Activities	10.5	29.0	18.3	-5.4
Net Increase in Cash and Cash equivalents	4.1	-0.8	-1.1	1.7
Add: Cash & Cash equivalents at the beginning of the period	0.2	1.0	2.1	0.4
Cash & Cash equivalents at the end of the period	4.3	0.2	1.0	2.1



Consolidated P&L



Particulars (INR Cr)	FY23	FY22	FY21	FY20
Revenue from operations	511.1	421.9	322.2	359.5
COGS	313.6	255.8	183.0	195.2
Gross Profit	197.5	166.1	139.2	164.3
Gross Profit Margin	38.6%	39.4%	43.2%	45.7%
Employee Expenses	82.9	72.2	62.2	66.2
Other Expenses	70.6	55.2	44.1	47.4
EBITDA	43.9	38.6	32.9	50.7
EBITDA Margin	8.6%	9.1%	10.2%	14.1%
Other Income	1.4	1.0	2.1	0.6
Depreciation	31.1	29.5	26.5	25.7
Finance Cost	11.7	6.5	3.8	2.6
Profit before Tax	-5.1	0.1	3.2	22.0
Tax expenses	0.8	0.9	1.1	3.8
Profit for the year	-5.9	-0.8	2.1	18.2
PAT Margins	-1.2%	-0.2%	0.7%	5.1%
EPS	-4.25	-0.6	1.5	13.0

Consolidated Balance sheet



Liabilities (INR Cr)	Mar-23	Mar-22	Mar-21	Mar-20
Equity				
Equity Share capital	14.0	14.0	14.0	14.0
Other Equity	280.7	289.9	292.2	289.2
Non Controlling Interest	0.0	0.0	0.0	0.0
Total Equity	294.7	303.9	306.2	303.2
Financial liabilities				
(i) Borrowings	79.9	78.9	44.6	12.0
(ii) Lease liabilities	0.3	0.9	0.0	0.0
(iii) Other Financial liabilities	0.0	0.1	0.0	0.0
Provisions	6.0	6.4	7.3	9.5
Other non current Liability	0.0	0.0	0.0	0.0
Deferred tax liabilities (Net)	5.1	6.0	6.7	7.0
Total Non Current Liabilities	91.3	92.2	58.5	28.5
Financial liabilities				
(i) Borrowings	70.9	29.2	7.6	9.9
(ii) Trade Payables	63.3	48.6	47.9	41.9
(iii) Other financial liabilities	6.4	6.4	7.9	4.3
(iv) Lease liabilities	0.6	0.8	0.0	0.0
Provisions	1.0	0.9	0.8	1.0
Other current liabilities	19.8	17.7	13.6	17.0
Current tax liabilities (Net)	0.0	0.0	0.7	0.1
Total Current Liabilities	161.9	102.7	78.5	74.1
Total Equity and Liabilities	548.0	499.5	443.2	405.8

Assets (INR Cr)	Mar-23	Mar-22	Mar-21	Mar-20
Non Current Assets				
Property, Plant and Equipment	309.7	273.9	234.9	221.7
Capital work-in-progress	9.0	20.8	20.1	8.4
Other Intangible Asset	8.3	8.8	9.0	8.5
Intangible assets Under Development	1.7	0.7	0.2	0.0
Right of Use Asset	0.9	1.6	0.0	0.0
Financial Assets				
(i) Investments	37.3	42.9	46.4	47.9
(ii) Loans		0.0	1.8	2.1
(iii) Other financial assets	4.6	5.1	3.0	2.4
Deferred Tax Assets (net)	0.0	0.0	0.0	0.0
Other non-current assets	10.2	10.3	10.7	8.7
Total Non Current Assets	381.7	364.2	326.1	299.7
Current Assets				
Inventories	76.1	56.1	45.0	49.6
Financial Assets				
Investments	4.5	2.7	0.0	0.0
(i) Trade receivables	65.1	55.9	60.4	40.0
(ii) Cash and cash equivalents	0.8	0.4	1.3	3.2
(iii) Other bank balances	0.1	0.1	0.2	2.9
(iv) Loans	0.1	0.0	0.5	0.4
(v) Other financial assets	2.1	1.8	1.7	0.5
Current Tax Assets(Net)	1.1	1.2	0.0	0.0
Other current assets	16.4	17.2	8.1	9.6
Total Current Assets	166.3	135.4	117.2	106.1
Total Assets	548.0	499.5	443.3	405.8

Consolidated Cash Flow



Particulars (INR Cr)	Mar-23	Mar-22	Mar-21	Mar-20
Net Profit Before Tax	-5.1	0.1	3.2	22.0
Adjustments for: Non Cash Items / Other Investment or Financial Items	49.0	37.7	28.6	28.7
Operating profit before working capital changes	43.8	37.8	31.9	50.7
Changes in working capital	3.4	-6.2	-4.4	-2.7
Cash generated from Operations	47.3	31.6	27.5	48.0
Direct taxes paid (net of refund)	2.3	3.6	-1.1	-12.2
Net Cash from Operating Activities	44.9	28.0	26.4	35.9
Net Cash from Investing Activities	-56.2	-70.9	-48.9	-27.5
Net Cash from Financing Activities	11.7	42.0	20.6	-5.6
Net Increase in Cash and Cash equivalents	0.4	-0.9	-1.9	2.8
Add: Cash & Cash equivalents at the beginning of the period	0.4	1.3	3.2	0.4
Cash & Cash equivalents at the end of the period	0.8	0.4	1.3	3.2



For further information, please contact

Company :



CIN: L74899DL1995PLC073281

Ms. Pankhuri Agarwal
investorservice@ppapco.com

www.ppapco.in

Investor Relations Advisors :

SGA Strategic Growth Advisors

CIN: U74140MH2010PTC204285

Mr. Aakash Mehta / Mr. Rahul Agarwal
aakash.s.m@sgapl.net / rahul.agarwal@sgapl.net
+91 98706 79263 / +91 98214 38864

www.sgapl.net