



Rane Engine Valve Ltd.

Registered Office:
" Maithri "
132, Cathedral Road,
Chennai 600 086.
India.
CIN : L74999TN1972PLC006127

Tel : 044 - 2811 2472
Fax : 044 - 2811 2449
URL : www.ranegroup.com

//Online submission//

REVL/SE/017/2024-25

May 16, 2024

BSE Limited Listing Centre Scrip Code: 532988	National Stock Exchange of India Ltd. NEAPS Symbol: RANEENGINE
--	---

Dear Sir / Madam,

Sub: Earnings Presentation – Audited Financial Results for the year ended March 31, 2024

Ref: Our letter no. REVL/SE/016/2024-25 dated May 14, 2024

This is with reference to the aforementioned letter intimating Earnings Conference Call scheduled on **Friday, May 17, 2024 at 15:00 hours (IST)**, inter alia, to discuss the audited financial results for the year ended March 31, 2024. We enclose herewith copy of the Earnings presentation proposed to be made thereat, to the analyst and investors.

The presentation, audio / video recordings (if any) and transcript are being made available as per the prescribed timelines on the investor information section website of the Company at the web-link <https://ranegroup.com/investors/rane-engine-valve-limited/>.

We request you to take the above on record and note the compliance with SEBI (Listing Obligations and Disclosure Requirements) Regulations, 2015 (SEBI LODR).

Thanking you,

Yours faithfully,

For **Rane Engine Valve Limited**

S Anand
Secretary

Encl: a/a

Rane Group

Earnings Presentation | Q4 FY24

Table of Contents



Q4 FY24 Financial & Operational Performance

Rane Group Overview



Rane Group

Q4 FY24 Financial & Operational Performance



To become the Preferred Trusted Supplier of Safety & Critical Auto Components

Strategic pillars of growth

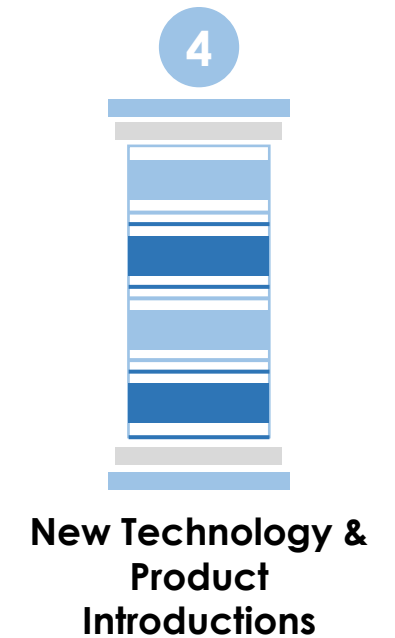
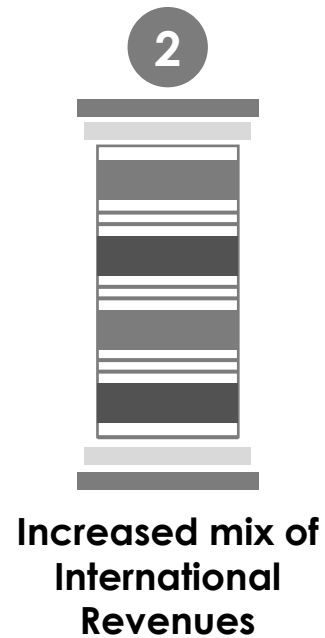

Business Drivers

- › **92%+ of revenue comes from powertrain agnostic products**
- › **Continued dominance on domestic market across major products**
- › **Increasing export mix for steering & linkages, valve train components and occupant safety products**
- › **Renewed focus on Aftermarket segment leveraging group level synergy**
- › **Continuous new product introductions leveraging strong in-house engineering capabilities**
- › **Increasing efficiencies across manufacturing facilities through operational excellence and digitalization.**

RANE BRAKE LINING

- Won Rs. 8 Cr order from various domestic customers
- Won orders worth Rs. 1.2 Cr from International aftermarket customers
- Won order worth Rs. 2 Cr from Railways

RANE (MADRAS)

- Won Rs. 82 Cr order for R&P from domestic PV customers and Rs. 71 Cr from International customers
- Won Rs. 23 Cr order for RCB from domestic CV customer
- Won Rs. 3 Cr order from domestic customers for various steering and suspension components

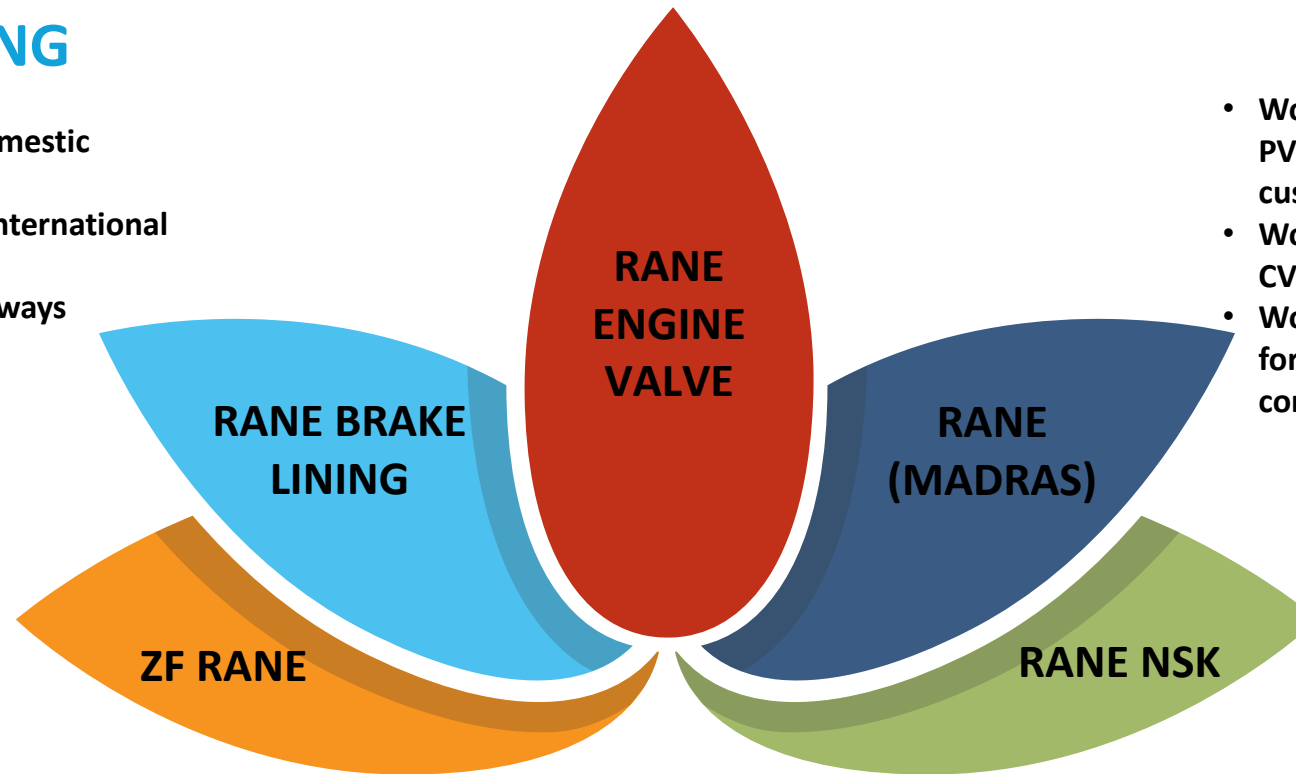

ZF RANE

- Won Rs. 17 Cr order for steering gear from domestic MHCV customer
- Won orders worth Rs. 7 Cr from domestic CV customers for EV application

RANE ENGINE VALVE





- Won Rs. 7 Cr order from domestic customer for UV model

RANE NSK

- Won new business worth Rs. 250 Cr for EPS from domestic customer for UV model
- Won Rs. 7.4 Cr order for Steering Column from domestic customer for M&HCV and LCV model

Won new business won worth Rs. 480 Cr during Q4 FY24

We continue to target higher than the industry growth

Industry Performance Review (Q4 FY24)	 Passenger Vehicle	 commercial Vehicle	 Farm Tractor	 2-Wheeler
Production YoY Growth# in %	10%	0%	-16%	26%
Rane Group Sales Growth YoY in % (India OEM)	11%	1%	-34%	16%
Rane Group Revenue Split * (India OEM)	64%	27%	4%	3%
	<ul style="list-style-type: none"> Higher growth than the industry driven by higher growth on served models 	<ul style="list-style-type: none"> Higher share of business and higher growth with served models/customers 	<ul style="list-style-type: none"> Higher drop is mainly due to higher drop in volumes on the served platforms 	<ul style="list-style-type: none"> Lower growth is due to EOP of supplies to select model in the segment

* Other segments such as Rail, Defence, Stationary Engines and 3-Wheeler contribute around 2%

Market Commentary

- The PV segment experienced record-high sales, propelled by improved vehicle availability and significant contributions from the SUV segment
- Drop in M&HCV segment and pre-buy in Q4FY23 resulted in muted performance of CV segment
- The drop in Farm tractor segment is due to erratic weather conditions which adversely affected agricultural output and income.

Group Aggregate Sales (Q4 FY24)

Group Aggregate Sales (Rs cr.)

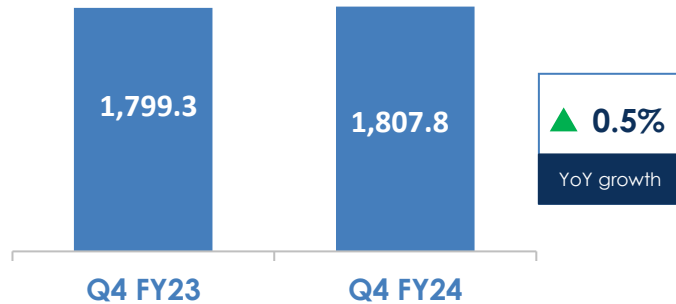

- › Sales increased by 0.5% from Rs. 1,799.3 Cr in Q4 FY23 to Rs. 1,807.8 Cr in Q4 FY24
- Revenue from Indian OE customers grew by 5% supported by strong growth in passenger vehicle segment
- Revenues from International customers decreased by 14% predominantly on account of divestment of LMCA business. On an organic basis it declined by 1%.
- Revenue from Indian aftermarket segment increased by 6%

Group Aggregate Sales (Q4 FY24)

BY PRODUCT (%)

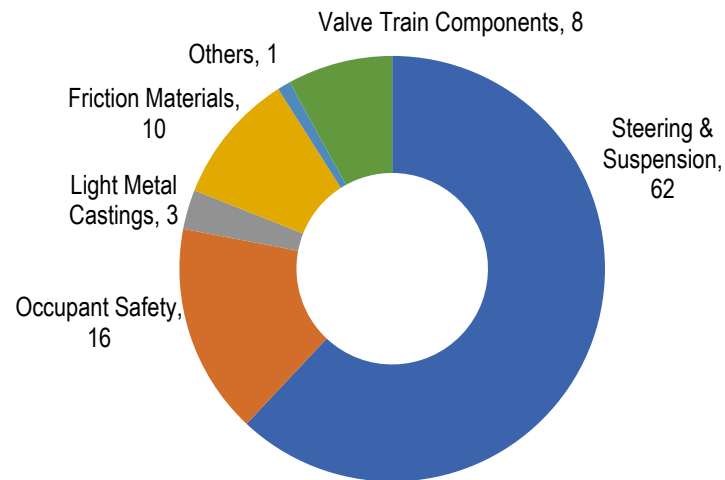

BY MARKET (%)

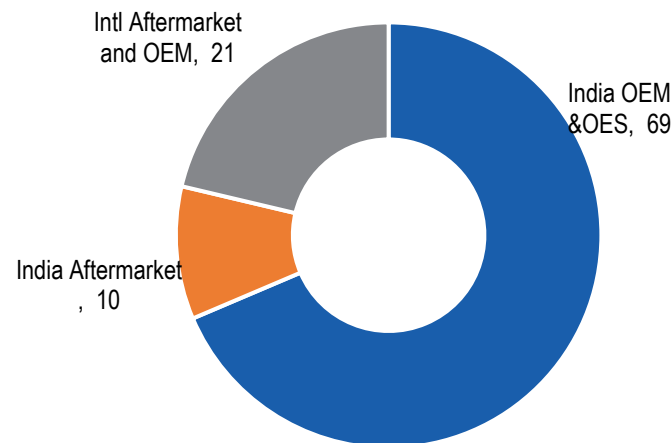

BY VEHICLE SEGMENT (%)

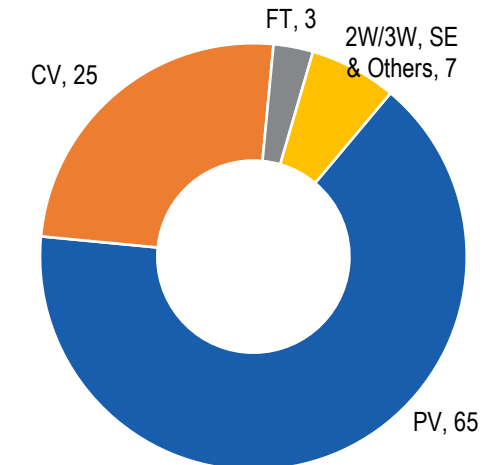

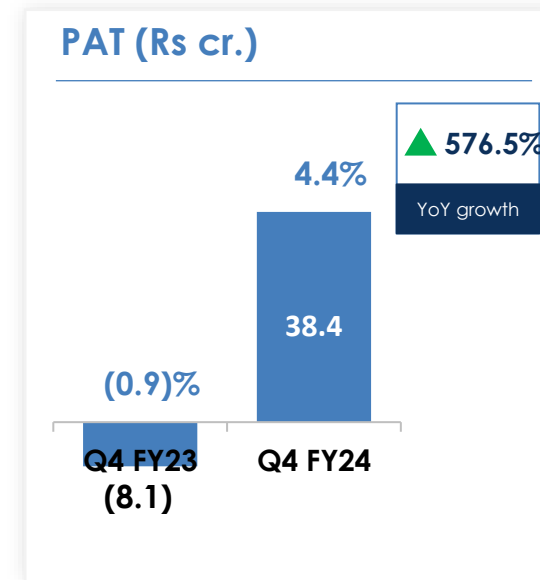
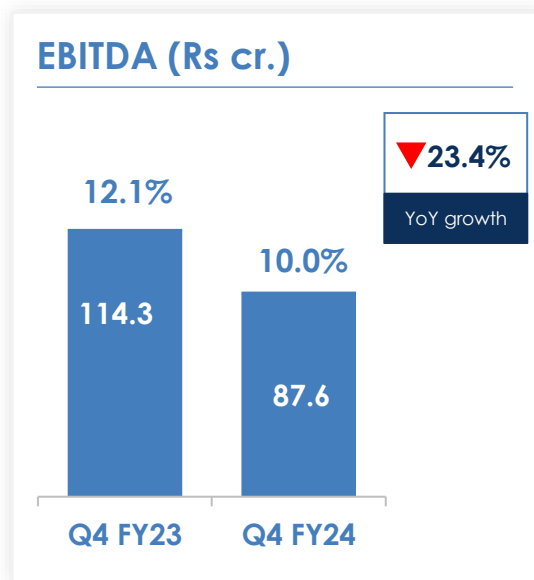
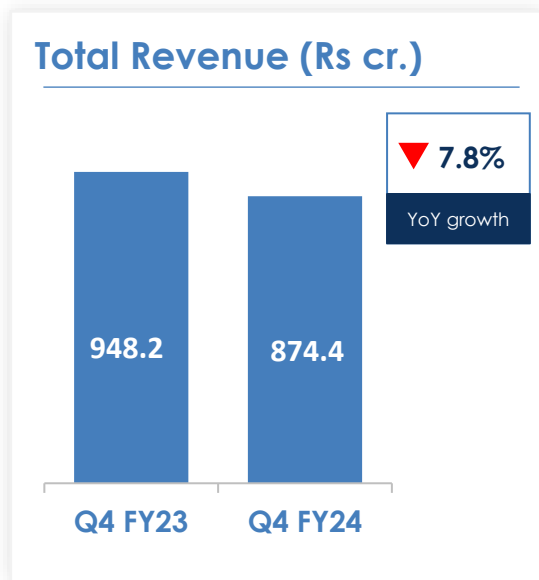

- › **Total Revenue decreased by 7.8% from Rs. 948.2 Cr in Q4 FY23 to Rs. 874.4 Cr in Q4 FY24**
- › **EBITDA decreased by 23.4% from Rs. 114.3 Cr in Q4 FY23 to Rs. 87.6 Cr in Q4 FY24**
- EBITDA margin decreased by 204 bps mainly due to certain one-off provisions and forex gain in Q4 FY'23.
- › **PAT increased by 576.5% from a loss of Rs.8.1 Cr in Q4 FY23 to a profit of Rs. 38.4 Cr in Q4 FY24**
- In Q4 FY'23 there was an exceptional expenses of Rs. 36.3 Cr in the share of Profit from JV / Associate entities
- Exceptional expenses of Rs. 7.02 Cr in Q4 FY'24 towards merger related expenses and customer claim (Rs. 11.03 Cr in Q4 FY'23 towards VRS and impairment provision)

Particulars	FY' 24	FY' 23
Debt : Equity	0.91	1.06
ROCE	12.50%	12.73%
EPS (Rs.)	86.67	43.61
DPS	25.00	17.00
BV(Rs.)	634.66	565.74

Rane (Madras) Limited

Q4 FY24 Financial & Operational Performance

Business Drivers

- › Challenging demand environment in India due to decline in the farm tractor segment
- › Drop in off-take of steering products in select export geographies

Operational Highlights

- › RML Puducherry won Best Prize for using Advanced Quality Control Tools in the 36th National Level Quality Circle Competition conducted by CII

Business Split (Q4 FY24) – RML India

BY MARKET (%)

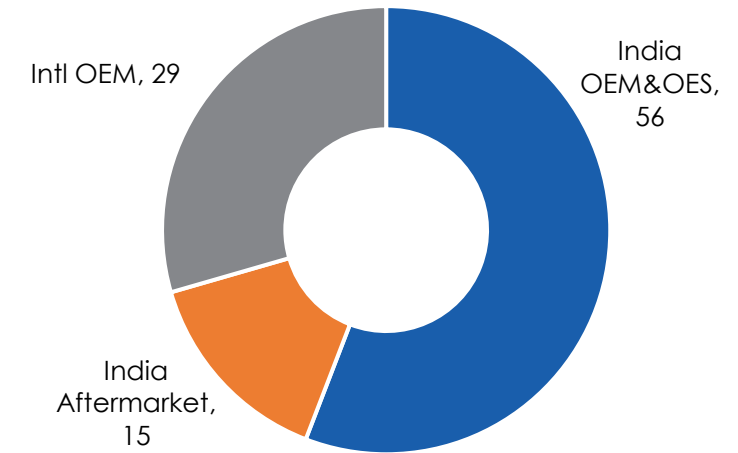

BY VEHICLE SEGMENT (%)

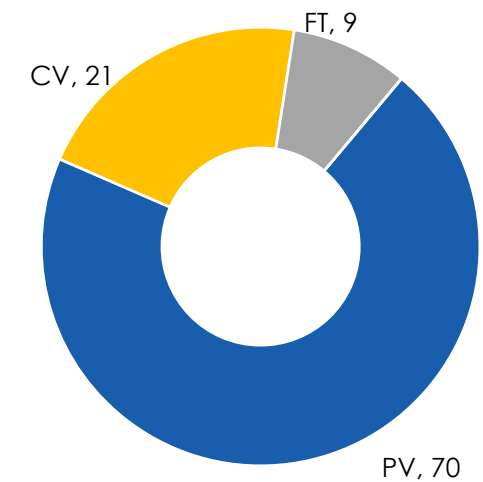

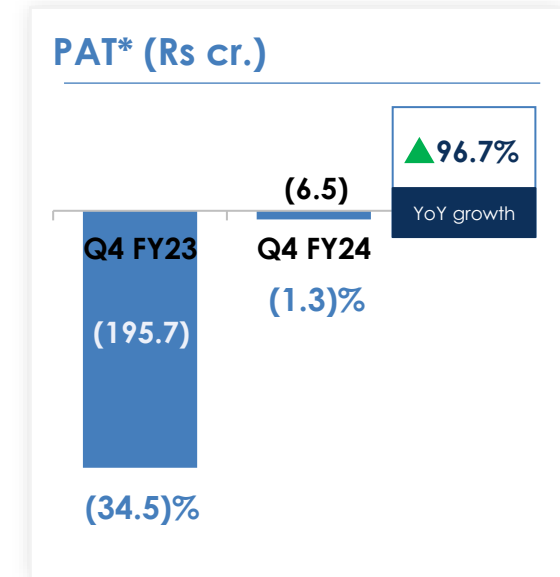
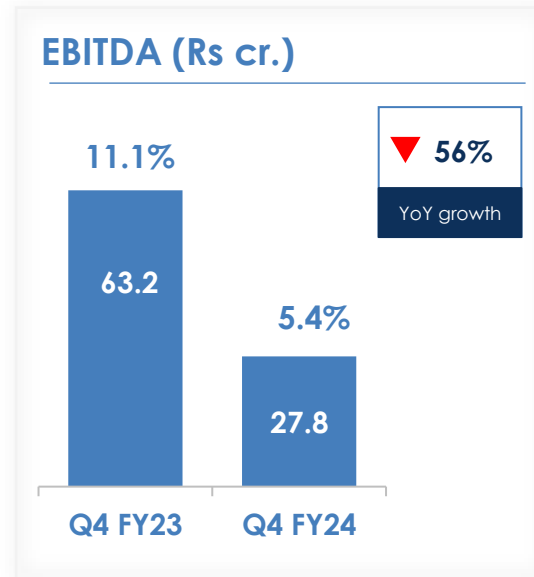
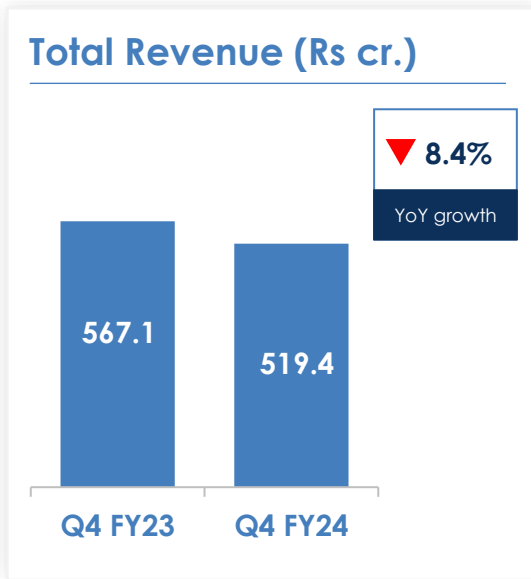

› **Total Revenue decreased by 8.4% from Rs. 567.1 Cr in Q4 FY23 to Rs. 519.4 Cr in Q4 FY24**

- Sales to Domestic OE customers dropped by 9% mainly due to drop in volume in M&HCV and Farm Tractor segment.
- Export Sales declined 10%. Lower off-take of steering products particularly in the ATV segment.
- Sales to Indian Aftermarket customers grew by 1%.

› **EBITDA decreased by 56% from Rs. 63.2 Cr in Q4 FY23 to Rs. 27.8 Cr in Q4 FY24. EBITDA Margin declined by 579 bps due to**

- Lower absorption of fixed cost due to sales drop, certain one-off provisions and forex gain in Q4 FY'23.

› **PAT increased by 96.7% from a loss of Rs. 195.7 Cr in Q4 FY23 to loss of Rs. 6.5 Cr in Q4 FY24**

- Exceptional expenses of Rs. 1.6 Cr in Q4 FY'24 towards merger related expenses (Rs. 223.3 Cr in Q4 FY'23 towards impairment of investment)

Particulars	FY' 24	FY' 23
Debt : Equity	2.68	2.12
ROCE	11.94%	20.14%
EPS (Rs.)	9.15	-77.80
BV(Rs.)	160.61	151.88

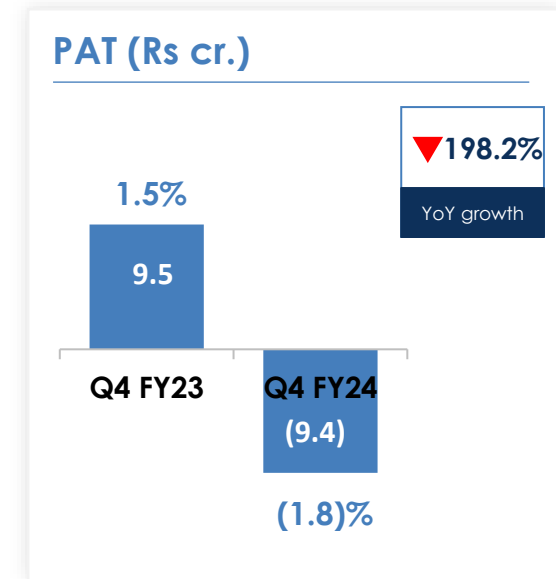
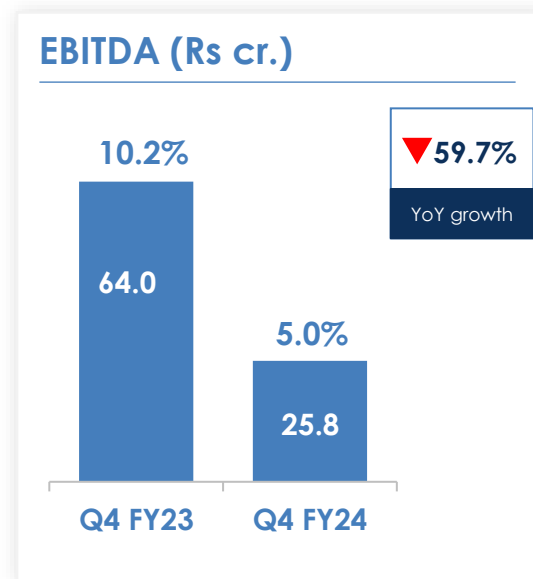
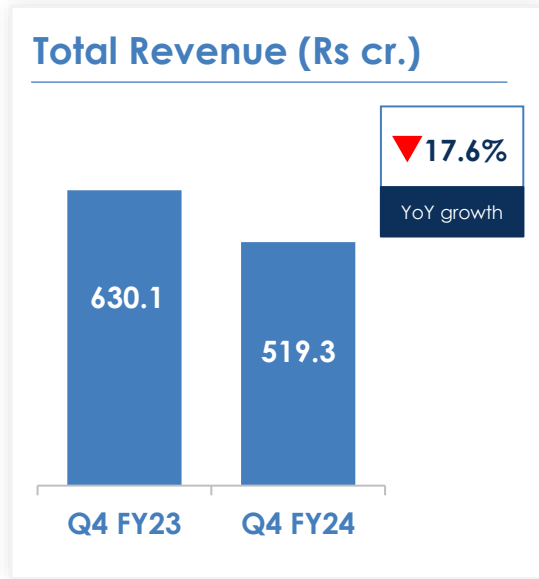

- › Total Revenue decreased by 17.6% from Rs. 630.1 Cr in Q4 FY23 to Rs. 519.3 Cr in Q4 FY24
- › EBITDA decreased by 59.7% from Rs. 64.0 Cr in Q4 FY23 to Rs. 25.8 Cr in Q4 FY24
- › PAT decreased from profit of Rs. 9.5 Cr in Q4 FY23 to a loss of Rs. 9.4 Cr in Q4 FY24

Particulars	FY' 24	FY' 23
Debt : Equity	2.74	2.72
ROCE	7.05%	11.53%
EPS (Rs.)	1.85	18.46
BV(Rs.)	157.32	148.52



Rane Engine Valve Limited

Q4 FY24 Financial & Operational Performance

Business Drivers

- › 41% of revenue generated from EV insulated segment
- › Improved financial performance driven by sales growth and better operational performance

Operational Highlights

- › Achieved highest sales for the quarter and fiscal year.
- › REVL Trichy received appreciation award for Best Kaizen implementation from Toyota Industries Engine India (TIEI)

Business Split (Q4 FY24)

BY MARKET (%)

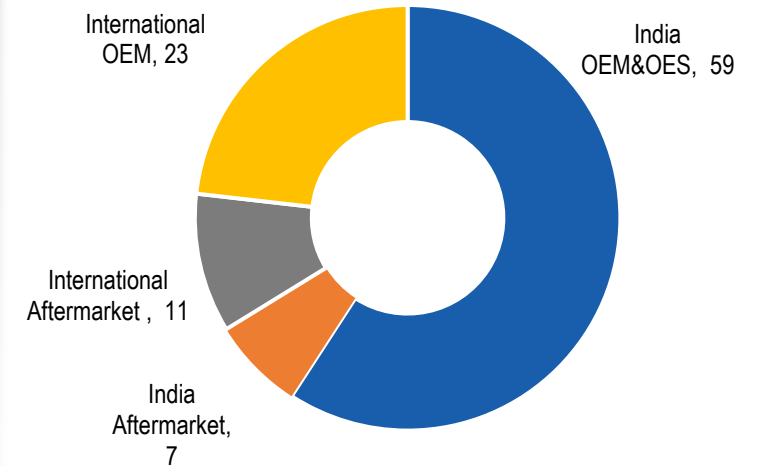

BY VEHICLE SEGMENT (%)

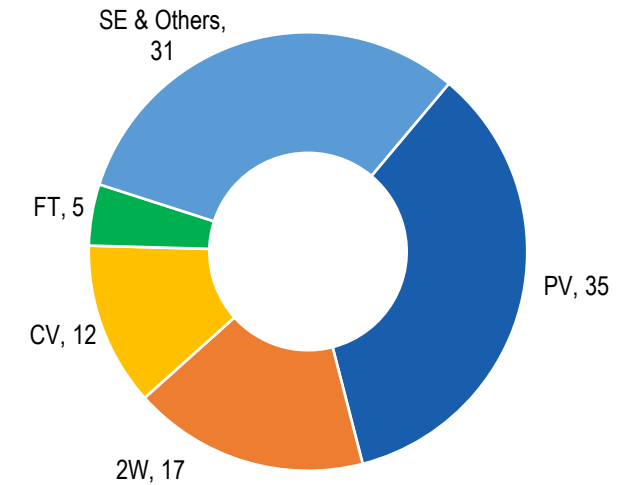

Total Revenue (Rs cr.)

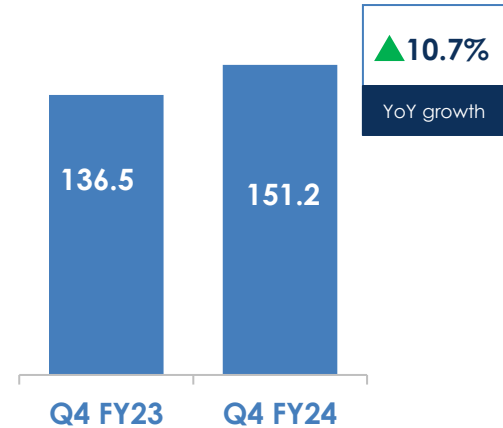

EBITDA (Rs cr.)

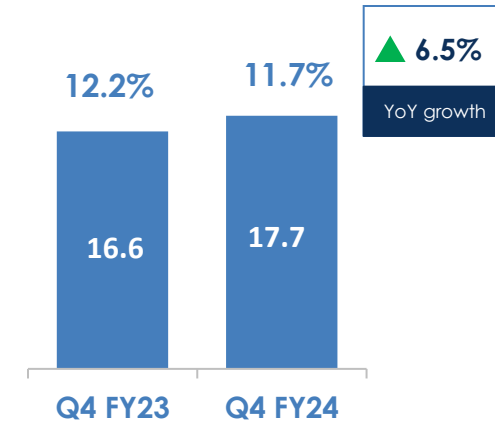

PAT (Rs cr.)

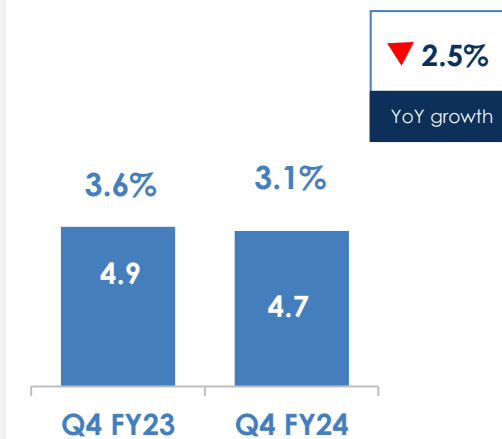

› **Total Revenue increased by 10.7 % from Rs. 136.5 Cr in Q4 FY23 to Rs. 151.2 Cr in Q4 FY24**

- Sales to India OE customers grew by 14% supported by strong off-take from Passenger Vehicle and Two Wheeler customers.
- Export Sales remained flat with 1% growth.
- Sales to Indian Aftermarket customers grew by 28%

› **EBITDA increased by 6.5% from Rs. 16.6 Cr in Q4 FY23 to Rs. 17.7 Cr in Q4 FY24**

- EBITDA margin declined by 46 bps due to adverse product mix.

› **PAT decreased from Rs. 4.9 Cr in Q4 FY23 to Rs. 4.7 Cr in Q4 FY24**

- Exceptional expenses of Rs. 4.2 Cr in Q4 FY'24 towards merger related expenses and customer claim (Rs. 1.99 Cr in Q4 FY'23 towards customer claim)

Particulars	FY' 24	FY' 23
Debt : Equity	1.01	1.30
ROCE	14.80%	8.10%
EPS (Rs.)	15.93	-0.09
DPS	5.00	-
Dividend payout (%)	32%	-
BV(Rs.)	167.00	148.47



Rane Brake Lining Limited

Q4 FY24 Financial & Operational Performance

Business Drivers

- › Market leader in Passenger Vehicle segment and increased penetration in two wheeler segment
- › Dominant presence in Aftermarket segment, which accounts for 40% of sales
- › Expanding the International Aftermarket segment

Operational Highlights

- › Achieved highest sales for the quarter and fiscal year.
- › Received Gold award from ACMA for Sustainable Business under Large Category
- › RBL Pondicherry has been certified as the Capable Supplier of Endurance Technologies Limited
- › RBL Pondicherry received Excellence in Technology Upgradation award from Endurance Technologies Limited

Business Split (Q4 FY24)
BY MARKET (%)

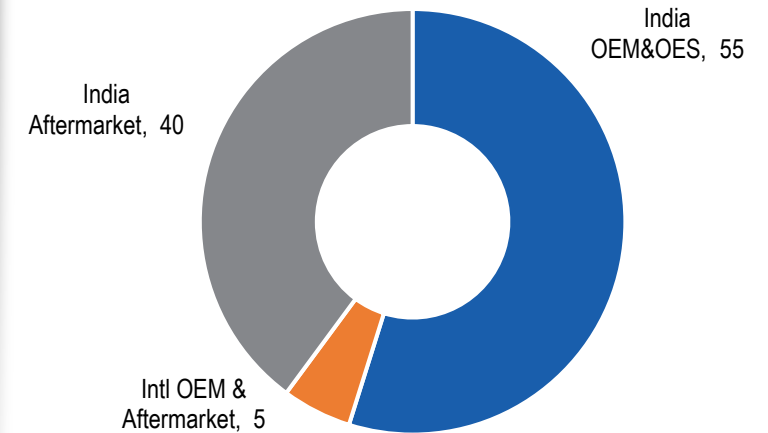

BY VEHICLE SEGMENT (%)

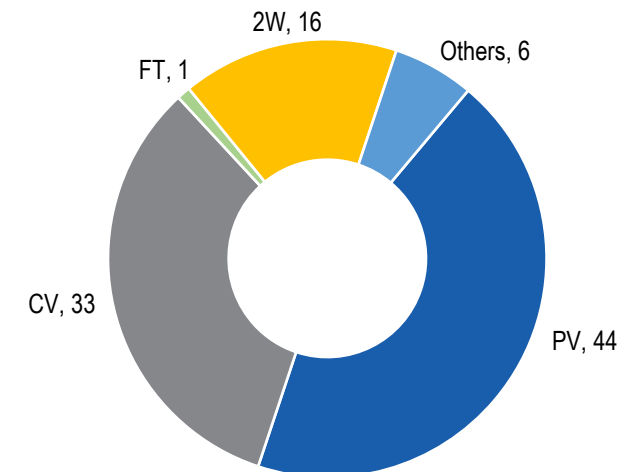

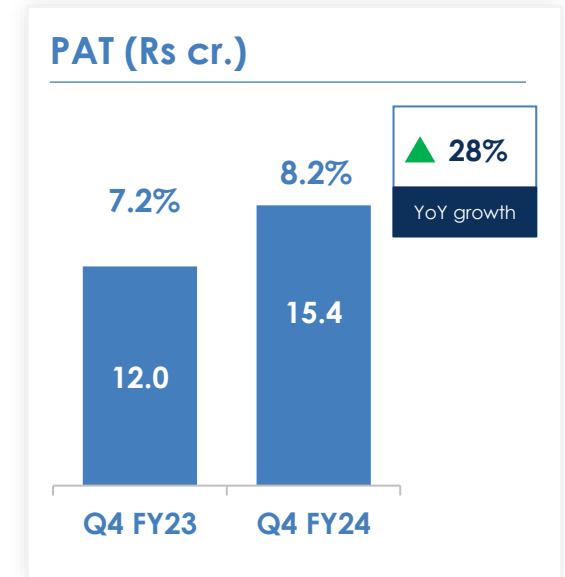
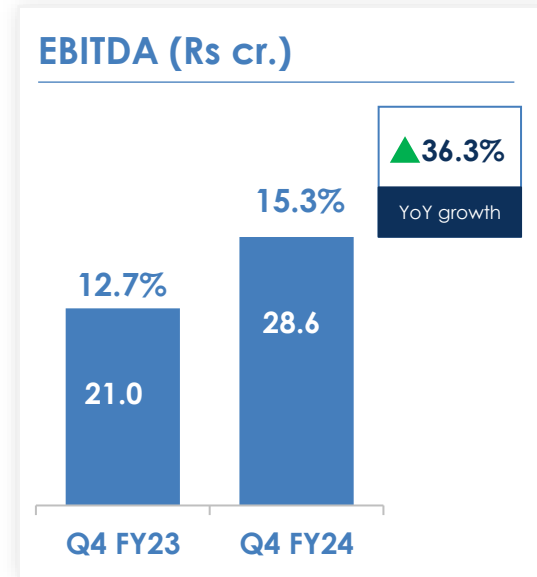
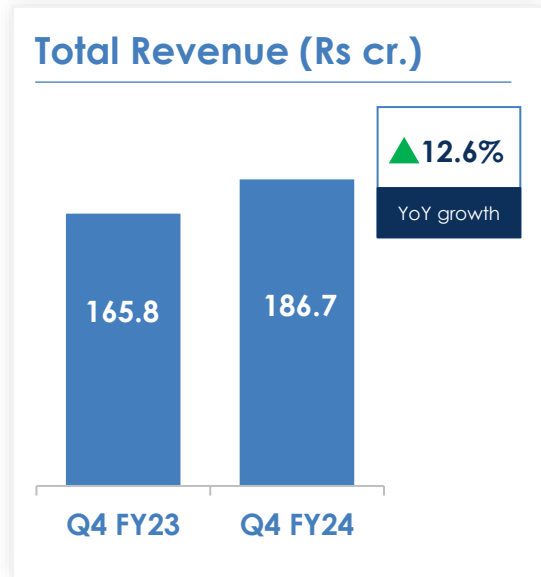

› **Total Revenue increased by 12.6% from Rs. 165.8 Cr in Q4 FY23 to Rs. 186.7 Cr in Q4 FY24**

- Sales to OE customer grew 18%, which was driven by strong sales to Two wheeler and Passenger vehicle segment.
- Sales to Aftermarket customers grew 6%

› **EBITDA increased by 36.3% from Rs. 21 Cr in Q4 FY23 to Rs. 28.6 Cr in Q4 FY24**

- EBITDA margin improved by 267 bps mainly driven by lower material prices and favourable forex. Operational improvement initiatives and energy savings initiatives helped to mitigate inflationary pressures on other operational costs.

› **PAT increased by 28% from Rs. 12 Cr in Q4 FY23 to Rs. 15.4 Cr in Q4 FY24**

- Exceptional expenses of Rs. 1.22 Cr in Q4 FY'24 towards merger related expenses

Particulars	FY' 24	FY' 23
Debt : Equity	-	-
ROCE	19.72%	17.07%
EPS (Rs.)	52.11	43.29
DPS	30.00	25.00
Dividend payout (%)	58%	58%
BV(Rs.)	363.63	337.88



ZF Rane Automotive India Private Limited

Q4 FY24 Financial & Operational Performance

Business Drivers

- › Sluggish M&HCV market impacted the growth of steering division
- › Increased preference for safety features helped demand from domestic customers for occupant safety products

Operational Highlights

- › Acquired the steering wheels manufacturer TRW Sun Steering Wheels Private Limited
- › Won the Runner up award in the National level Supplier Samrat competition conducted by Ashok Leyland

Business Split (Q4 FY24)

BY MARKET (%)

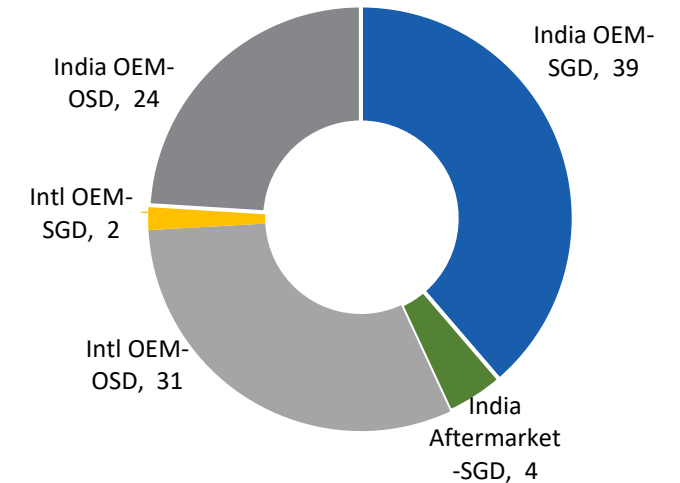

BY VEHICLE SEGMENT (%)

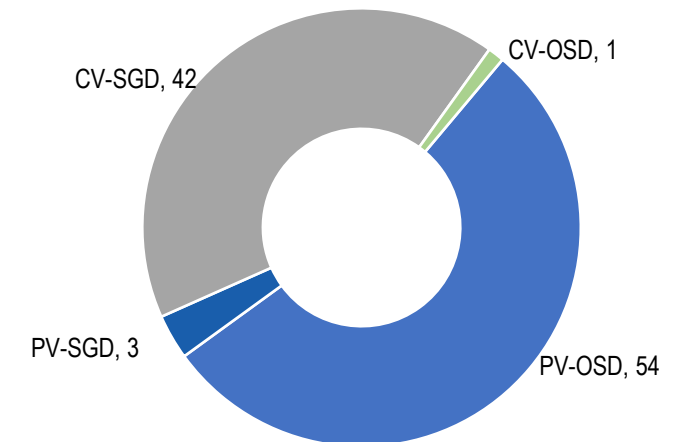

Total Revenue (Rs cr.)

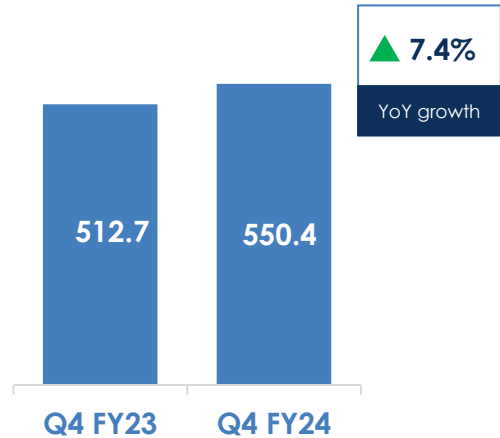

EBITDA (Rs cr.)

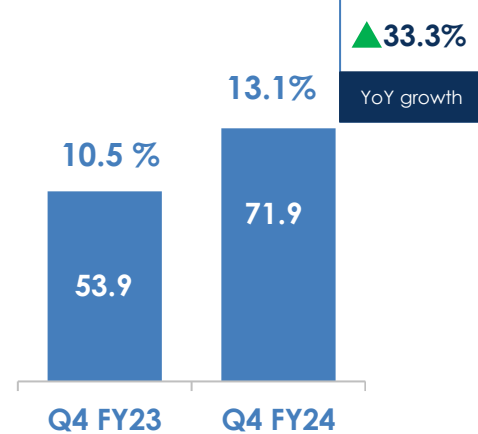

PAT (Rs cr.)

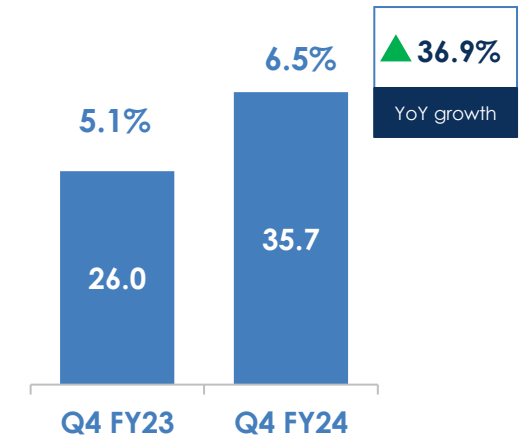

› **Total Revenue increased by 7.4% from Rs. 512.7 Cr in Q4 FY23 to Rs. 550.4 Cr in Q4 FY24**

- Revenue from steering gear products decreased 1% due to sluggish MHCV market
- Revenue from occupant safety systems grew 13% supported by strong offtake from domestic customers

› **EBITDA increased by 33.3% from Rs. 53.9 Cr in Q4 FY23 to Rs. 71.9 Cr in Q4 FY24**

- EBITDA margin improved mainly due to one-off gain

› **PAT increased by 36.9% from Rs. 26.0 Cr in Q4 FY23 to Rs. 35.7 Cr in Q4 FY24**

Particulars	FY' 24	FY' 23
Debt : Equity	1.15	0.65
ROCE	14.88%	17.48%
EPS (Rs.)	122.27	111.27
DPS	83.75	77.00
Dividend payout (%)	69%	70%
BV(Rs.)	606.52	563.04



Rane NSK Steering Systems Private Limited

Q4 FY24 Financial & Operational Performance

Business Drivers

- › Favorable growth in served models with the key customer

Operational Highlights

- › Received Certificate of Appreciation from Suzuki Motor Gujarat for Superior Performance in the field of Quality Performance (Zero Defect)

Business Split (Q4 FY24)

BY MARKET (%)

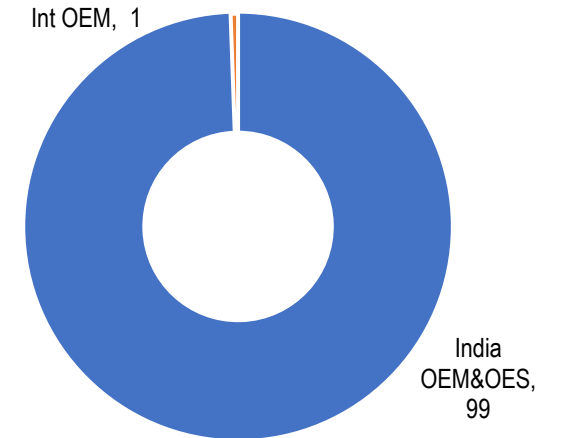

BY VEHICLE SEGMENT (%)

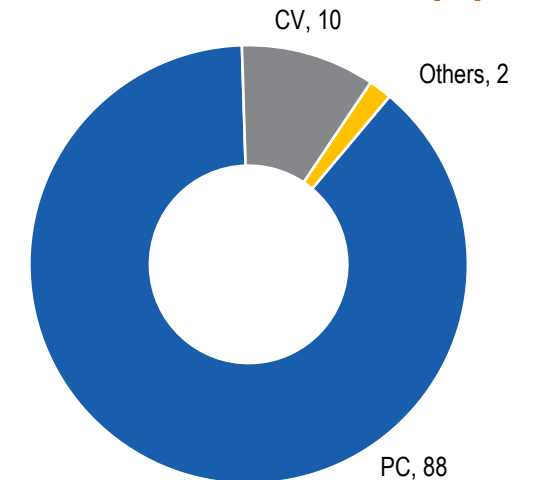

Total Revenue (Rs cr.)



EBITDA (Rs cr.)

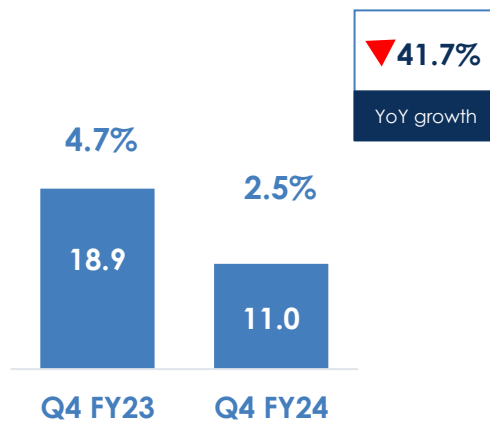

PAT (Rs cr.)

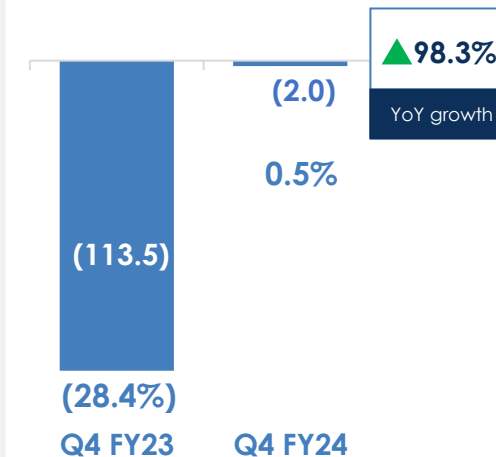

- › **Total Revenue increased by 11.7% from Rs. 400.2 Cr in Q4 FY23 to Rs. 447.1 Cr in Q4 FY24**
 - The growth is driven by higher growth on served models
- › **EBITDA decreased by 41.7% from Rs. 18.9 Cr in Q4 FY23 to Rs. 11.0 Cr in Q4 FY24**
 - Adverse mix impacted the profitability
- › **PAT improved from loss of Rs. 113.5 Cr in Q4 FY23 to loss of Rs. 2.0 Cr in Q4 FY24**
 - Exceptional expenditure of Rs. 74 Cr in Q4 FY'23 towards warranty provision.

Particulars	FY' 24	FY' 23
Debt : Equity	24.42	92.16
ROCE	6.62%	18.11%
EPS (Rs.)	5.86	-55.37
BV(Rs.)	7.44	1.86



Rane Group

About Us



Founded in 1929 and headquartered in Chennai, Rane Group is one of the preferred OE manufacturer and supplier for global auto majors



The Group serves a variety of industry segments: Passenger Vehicles, Commercial Vehicles, Farm Tractors, Two-wheelers, Three-wheelers, Railways and Stationary Engines



Manufactures Steering and Suspension systems, Friction materials, Valve train components, Occupant safety systems and Light metal casting products.

REVENUE BY MARKET (%)

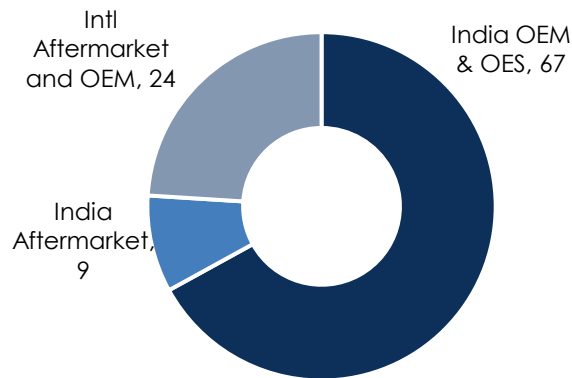

REVENUE BY VEHICLE SEGMENT (%)

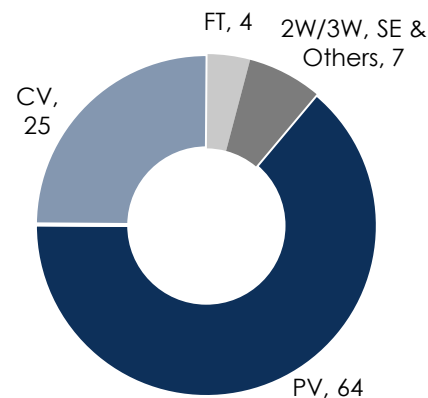

GROUP SALES OF INR 7,199 CR (~USD 870 MN)

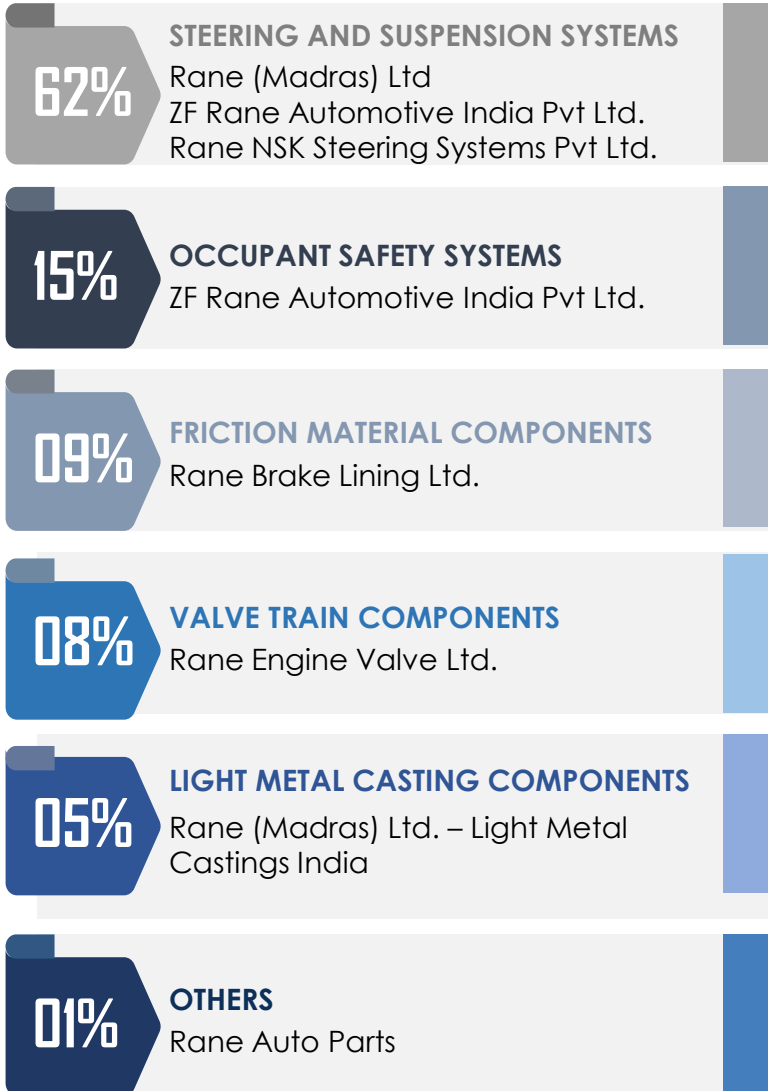

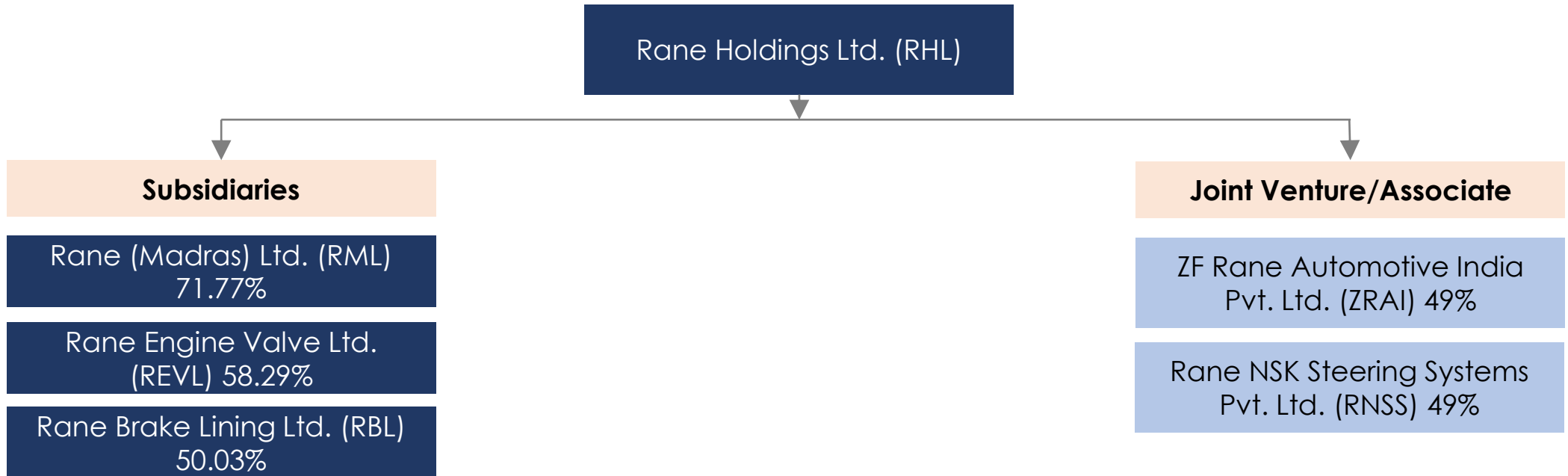

 Listed

Share holding as on 31 March 2024

- Market leader in steering gear and steering linkage products in India. We have started catering to hydraulic products such as HSU and steering cylinders.
- Best in class manufacturing facilities at Chennai, Mysore, Puducherry and Pant Nagar.
- End to end testing facilities in house to validate the products' functional, endurance and environmental parameters.

PRODUCTS

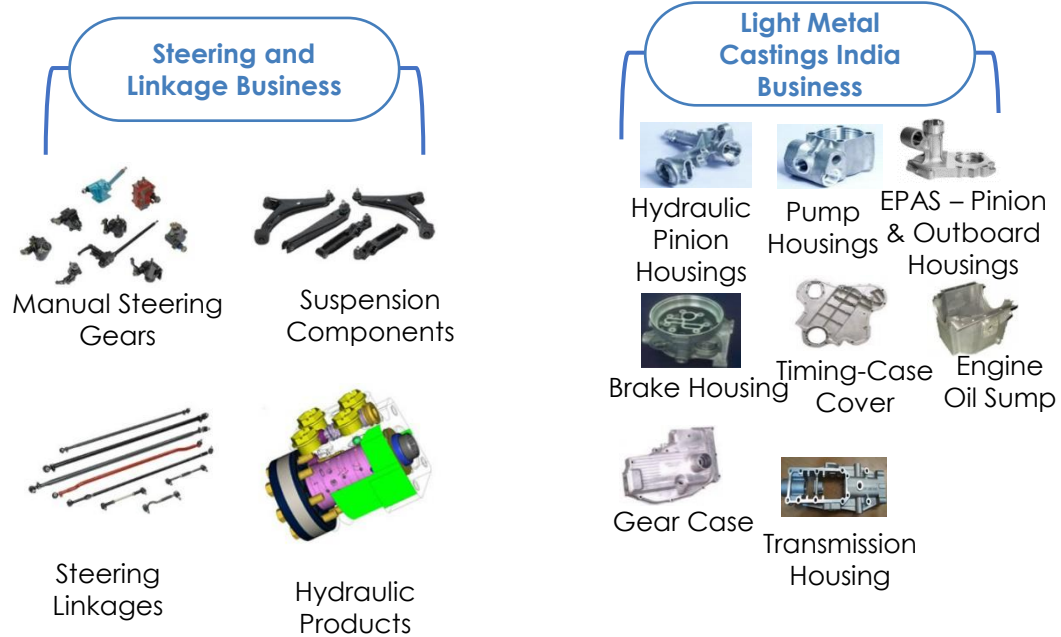

MANUFACTURING PLANT

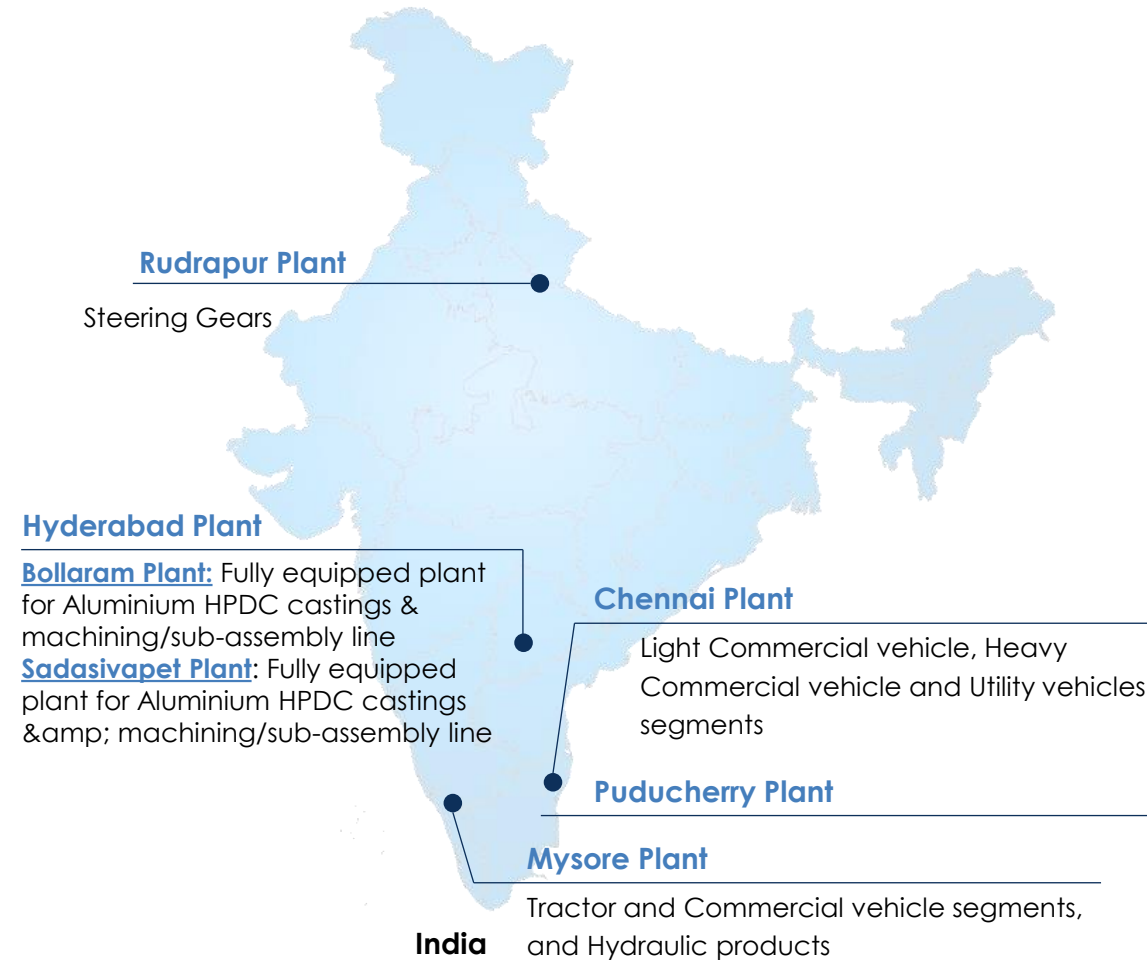

- Incepted In 1959, REVL manufactures valves and valve train components for various engine applications
- Non Automotive applications such as power generation, marine, defence, locomotive, etc.
- Comprehensive test laboratory for material characterisation, simulated test rigs and engine dynamometer test facility.

PRODUCTS

Engine Valves



Valve Guides



Mechanical Tappets



MANUFACTURING PLANT



Hyderabad Plants (2)

Small Valves for 2W and PC
Medium Valves for PC, Industrial and CV

Tumakuru Plant

Medium Valves for CV and Farm Tractors
Large & Extra Large Valves for Industrial, Power Generation and Marine Applications

Chennai Plant

Small Valves for 2W and PC
Medium Valves for Tractors and PC Guides, Tappets

Trichy Plant

Small & medium Valves for 2W, PC and CV

- Established in 1964, RBL is a leader in Friction Products across OEM segments and supplies products to over 15 countries
- Technical collaboration with Nisshinbo Brakes Inc. and TMD Friction
- Library of widely tested and approved formulations to suit diverse market / customer requirements.
- State-of-the-art R&D center equipped with full scale inertia dynamometer, static mu-measurement and NVH study rig.

PRODUCTS

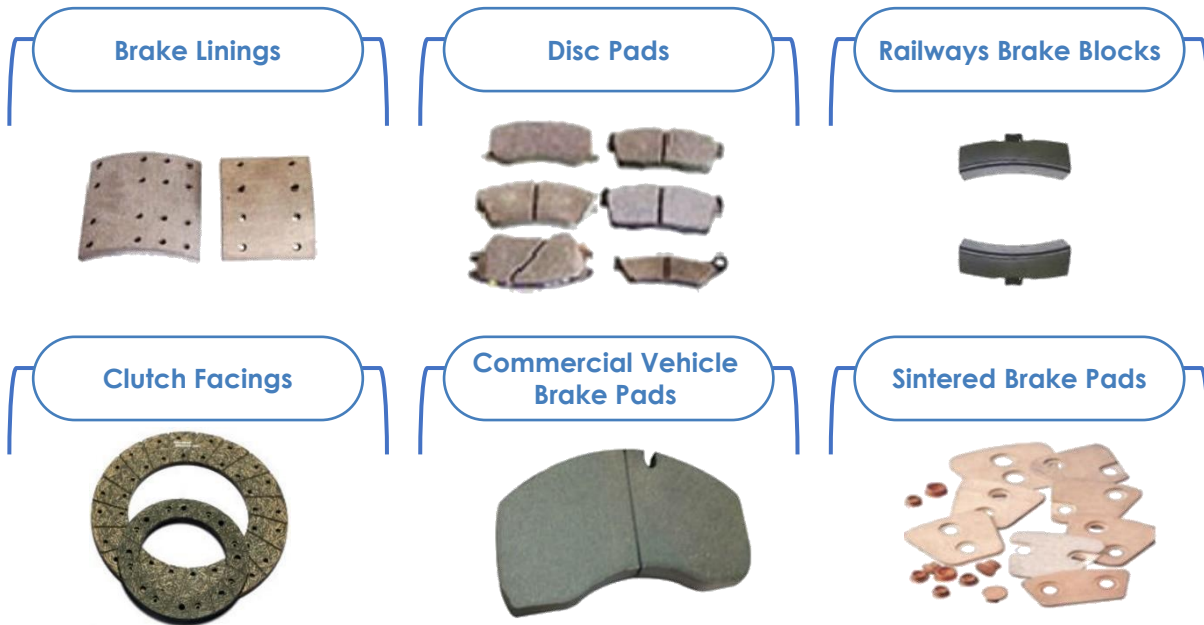

MANUFACTURING PLANT

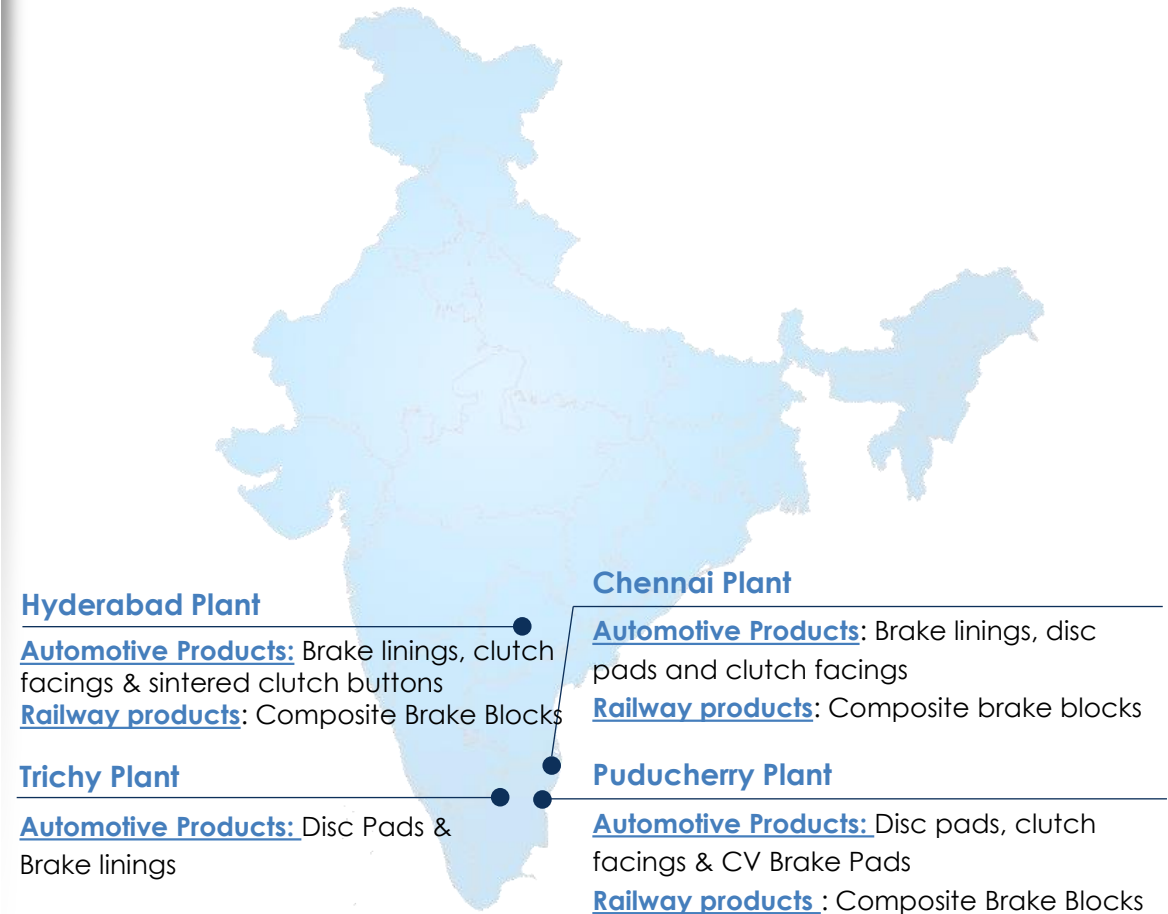

Joint venture partnership with ZF Group, Germany.

Steering Gear Division

- Design, Development and Application capability for complete Hydraulic Power Steering system for all vehicles.
- Advanced design tools for 3D modeling, simulation, FE analysis and CFD.
- State-of-the-art testing facilities for strength, environment, noise, fatigue and durability tests to meet global standards

Occupant Safety Division

- Product range includes different types of airbags and latest seatbelt technologies, Retractor and Anchor pretensioners, Emergency Locking Retractor (ELR), Load Limiters, Child Restraint Seat Belt, Driver Airbag, Passenger Airbag, Side Airbag and Curtain Airbags.
- Extensive testing facilities for seat belts include Extraction and Retraction Force Testing Machine, Retractor Durability Tester, Hot & Cold Chamber, Salt spray chamber, ELR functional tester.
- Equipped with Test lab to carry out testing as per National (IS/AIS), International (ECE/EEC/GS/VSCC), customer specifications and COP testing

PRODUCTS

Steering Gear Division



Occupant Safety Division



MANUFACTURING PLANT

Rudrapur Plant

Steering Gears and Pumps

Chennai Plant (4)

Pump and Power Rack & Pinion division, Occupant Safety Products

Tiruchirapally Plant (3)

Fully integrated gear, Occupant Safety Products

- Joint venture partnership with NSK, Japan.
- State-of-art R&D test lab for validation of steering columns.
- Manufacturing facilities across four locations in Chennai, Bawal, Rudrapur & Ahmedabad.
- Design & Development capability for solid & energy absorbing columns. Development and application capability for EPS.
- Driver comfort, Passenger safety, Ergonomics and NVH requirements are kept as targets while designing steering system.
- Comprehensive test laboratory for extensive research about column performance characteristic validation, strength and durability validation and NVH requirements.
- Design team includes CAD & CAM application experts and software analysts.

PRODUCTS



MANUFACTURING PLANT

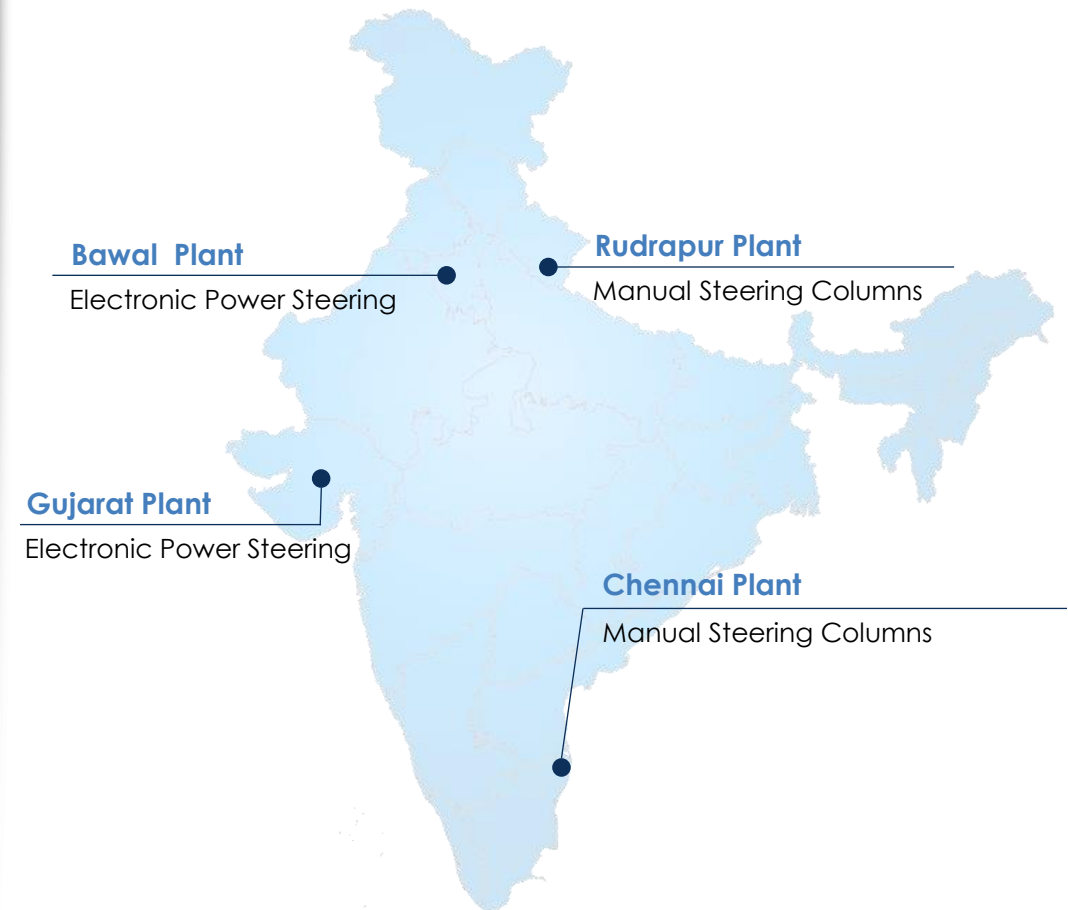

Light Metal Casting Products

Pinion Housing

Engine Timing Case Cover

Outboard Housing

Valve train Components

Engine Valves

Occupant Safety Systems

Seat Belts

Airbags

Friction Materials

Brake Lining

Disc Pad

Upper Control Arm

Stabilizer Link

Lower Control Arm

Steering & Suspension Systems

Suspension Ball Joint

Outer Ball Joint

Inner Ball Joint

Power Steering Pump

Rack & Pinion steering gear
-Mechanical
-Hydraulic

Electric Power Steering Columns

Rane (Madras)

- › Manual Steering Gears
- › Steering Linkages
- › Suspension Components
- › Light Metal Casting Products

Rane Engine Valve

- › Engine Valves

Rane Brake Lining

- › Brake Linings
- › Disc Pads

Rane NSK Steering Systems

- › Electric Power Steering Systems

ZF Rane Automotive India Pvt Ltd.

- › Hydraulic Power Steering systems
- › Seat Belts
- › Airbags

Steering & Suspension Systems

-  Manual Steering Column
-  Power Steering Gear
-  Power Steering Pump
-  Manual RCB Steering Gear
-  Drag Link Assembly
-  Tie Rod Assembly
-  Hydraulic Cylinder (Twin/multi front axle trucks)

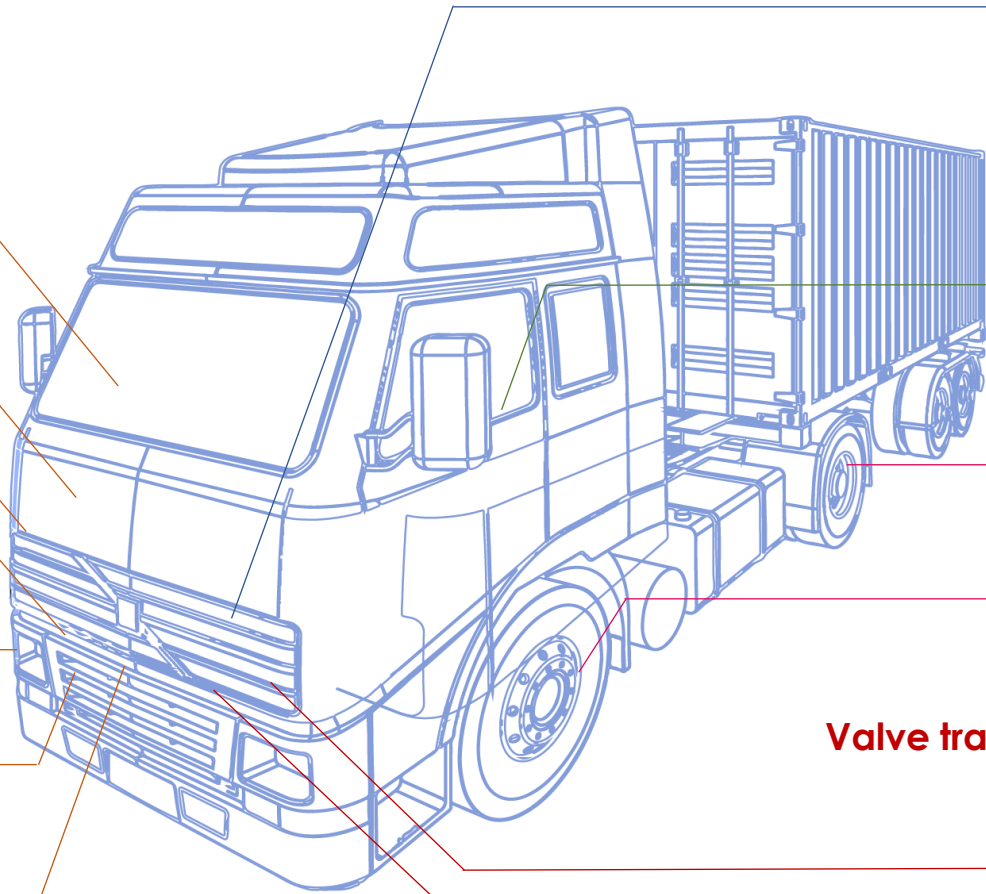

Light Metal Casting Products

Hydraulic Pump Housing



Occupant Safety Systems

Seat Belts



Friction Materials

Brake Lining

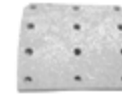

Disc Pad



Valve train Components

Valve Guides



Engine Valves



Rane (Madras)

- › Manual Steering Gears
- › Steering Linkages
- › Hydraulic Cylinders
- › Light Metal Casting Products

Rane Engine Valve

- › Engine Valves
- › Valve Guides

Rane Brake Lining

- › Brake Linings
- › Brake Pads

Rane NSK Steering Systems

- › Manual Steering Column

ZF Rane Automotive India Pvt Ltd.

- › Hydraulic Power Steering Systems
- › Seat Belts

Steering & Suspension Systems



Manual Steering /
Column
Manual RCB
Steering Gear



Hydrostatic
Steering Unit



Power Steering
Gear



Drag Link Assembly



Tie Rod Assembly

Hydraulic
Cylinder



Friction Materials

Clutch Facings



Brake Lining

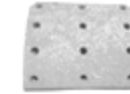

Light Metal Casting Products

Timing Case Covers



Seat Belts



Valve train components

Valve Guides



Engine Valves



Rane (Madras)

- › Manual Steering Gears
- › Steering Linkages
- › Hydraulic Cylinders
- › Hydrostatic Steering Unit
- › Light Metal Casting Products

Rane Engine Valve

- › Engine Valves
- › Valve Guides

Rane Brake Lining

- › Brake Linings
- › Clutch Facings

Rane NSK Steering Systems

- › Manual Steering Column

ZF Rane Automotive India Pvt Ltd.

- › Hydraulic Power Steering systems
- › Seat Belts

Friction Materials

Disc pad

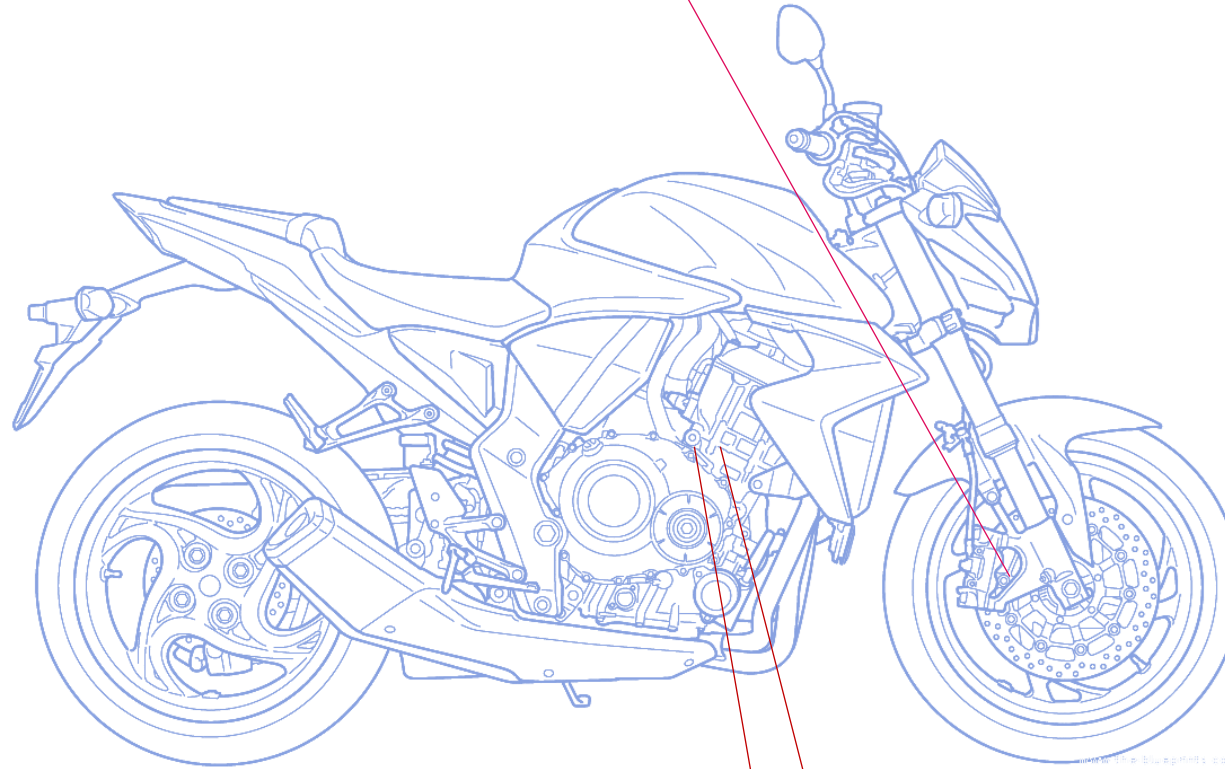

Rane Brake Lining

- › Disc Pads

Rane Engine Valve

- › Engine Valves
- › Valve Guides

Valve train Components

Valve Guides



Engine Valves



Rane Group Product Range for Other Applications

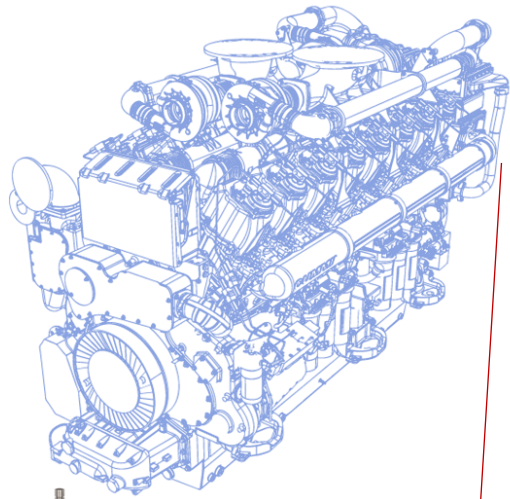

Engine Valves / Valve Guides

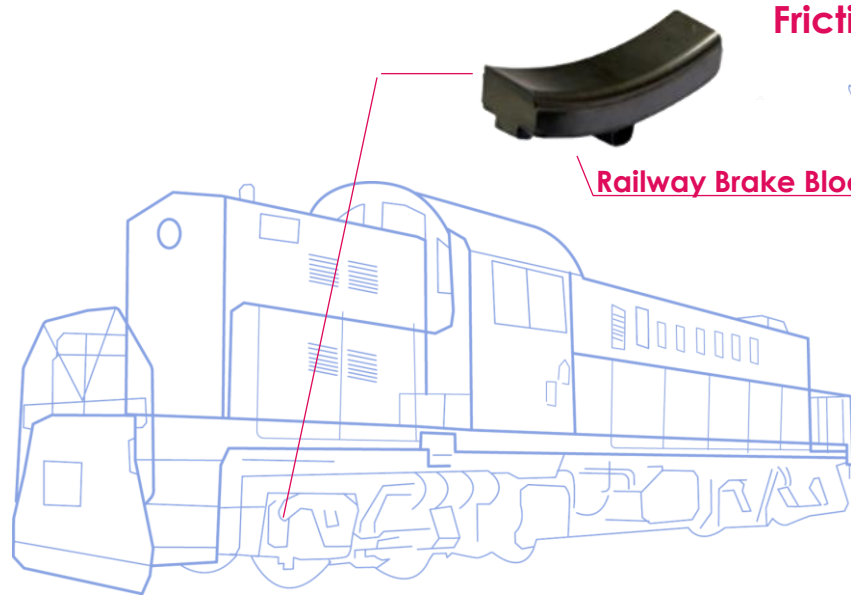
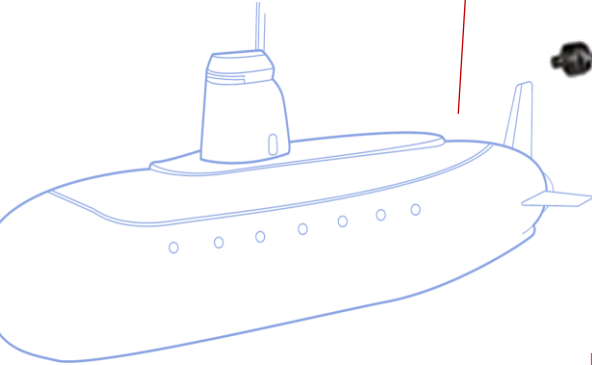

Railway Brake Block

Friction Materials



Sintered Brake Pads

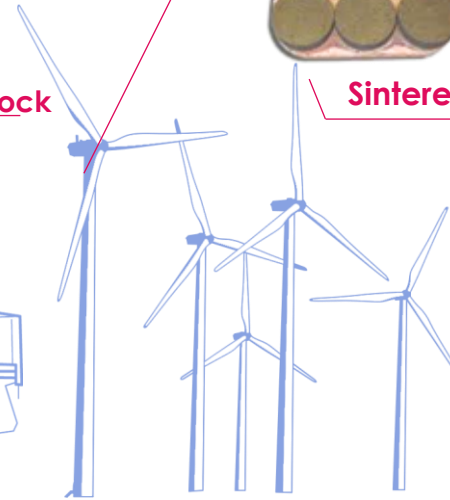

Suspension Ball Joint

Outer Ball Joint

Inner Ball Joint

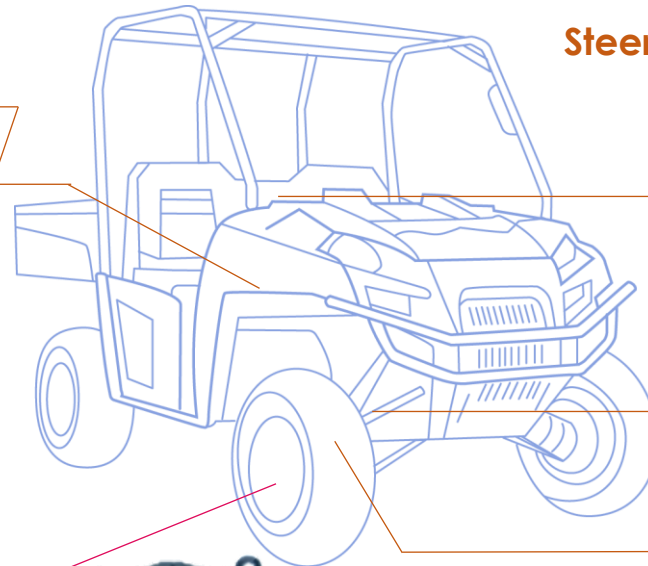

Steering & Suspension Systems



Steering Shafts



Rack & Pinion steering gear -Mechanical



Stabilizer link

Friction Materials

Disc pad



Rane (Madras)

- › Manual Steering Gears
- › Steering Linkages
- › Light Metal Casting Products

Rane Engine Valve

- › Engine Valves
- › Valve Guides

Rane Brake Lining

- › Sintered Brake Pads
- › Railway Brake Block

Rane NSK Steering Systems

- › Steering Shafts

An illustrious journey of over 80 years from distributor of automobile and auto components to winner of Deming prize for manufacturing

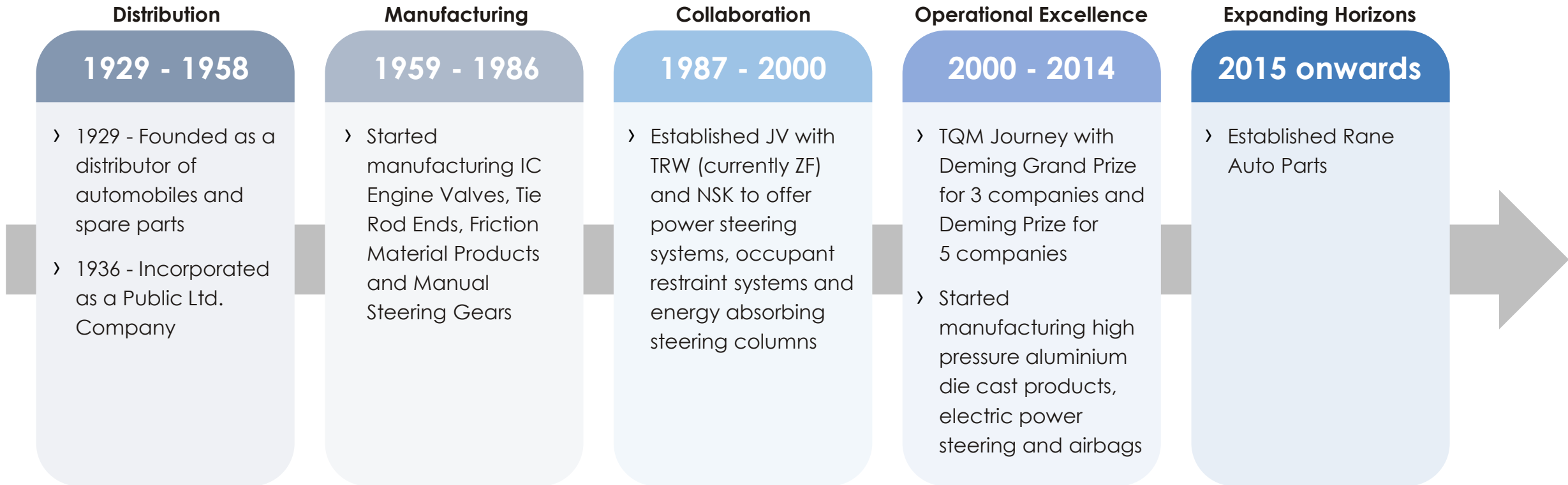



30+ Serve customers in 30+ countries

27 Manufacturing locations across India

Customer Locations Manufacturing Locations Sales Offices

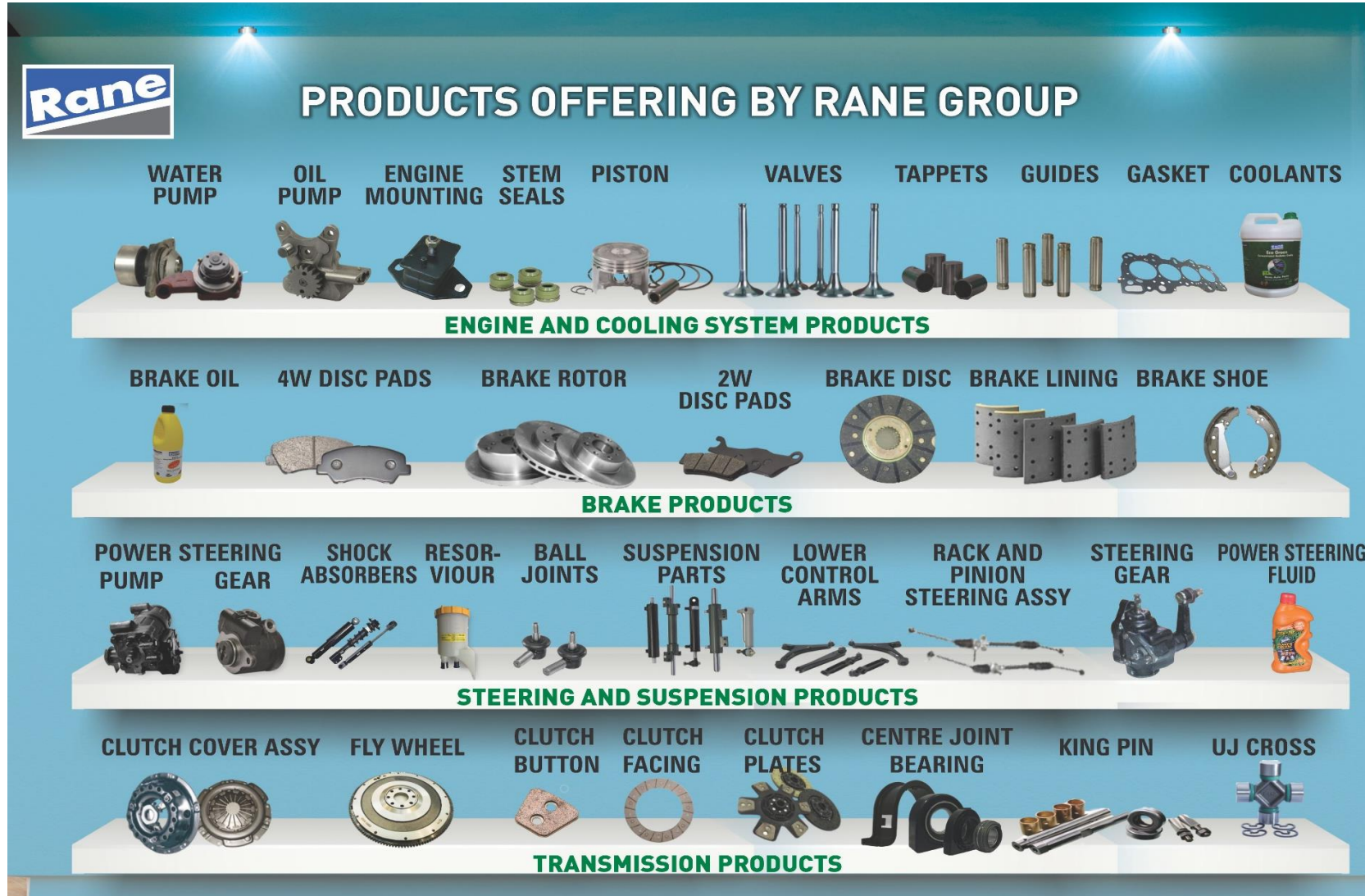

Rane

PRODUCTS OFFERING BY RANE GROUP

ENGINE AND COOLING SYSTEM PRODUCTS

- WATER PUMP
- OIL PUMP
- ENGINE MOUNTING
- STEM SEALS
- PISTON
- VALVES
- TAPPETS
- GUIDES
- GASKET
- COOLANTS

BRAKE PRODUCTS

- BRAKE OIL
- 4W DISC PADS
- BRAKE ROTOR
- 2W DISC PADS
- BRAKE DISC
- BRAKE LINING
- BRAKE SHOE

STEERING AND SUSPENSION PRODUCTS

- POWER STEERING PUMP
- SHOCK ABSORBERS
- RESOR-VIOUR
- BALL JOINTS
- SUSPENSION PARTS
- LOWER CONTROL ARMS
- RACK AND PINION STEERING ASSY
- STEERING GEAR
- POWER STEERING FLUID

TRANSMISSION PRODUCTS

- CLUTCH COVER ASSY
- FLY WHEEL
- CLUTCH BUTTON
- CLUTCH FACING
- CLUTCH PLATES
- CENTRE JOINT BEARING
- KING PIN
- UJ CROSS

Increasing Group's brand presence in aftermarket through enhanced product portfolio and wider market reach

Strong CAE Capabilities – Design, Analysis & Simulation Software

230 R&D Engineers

42 Functional Test Rigs

26 Strength Test Rigs

62 Durability Test Rigs

33 Environmental Test Rigs

10 Noise Test Rigs



Hydraulic Power Steering Systems and Occupant Safety Systems



Energy Absorbing Steering Columns and Electric Power Steering



Brake Linings, Discs Pads and Clutch Facings

We create and deliver value to our customers

Passenger Vehicle



Commercial Vehicle



Farm Tractor



Two/Three-Wheeler



Other Applications



INDIA



INTERNATIONAL

‘Customer at the core’ remains our priority on the goal to sustainable growth and profitability



Rane Group

Customer	Award Category
Mahindra & Mahindra	Business Partner of the year – Automotive Division
Ki Mobility Solutions	Partnership of Excellence



Rane (Madras)

Customer	Award Category
Volvo Eicher	New Product Development Award
Nexteer TAFE	Perfect Quality Award Best Supplier & Benchmark Award
Maruti Suzuki	Superior Performance Award, Special Support
SML Isuzu	New Product Development Award
Tata Motors	Award for Exceptional Support, Best Supplier – Demand Fulfillment
Toyota Industries	Best Target Achieved Supplier Award
Polaris	Supplier of Excellence
Daimler India	Reliable Partner & Achieving 100% in delivery



Rane Engine Valve

Customer	Award Category
Groupe Renault	Quality & Customer Satisfaction
John Deere India	Quality Appreciation Award
Volvo Eicher	Quality & Delivery excellence
Renault Nissan	Quality & Customer Satisfaction
Hyundai	Appreciation Award
Cummins India	Superior Quality Award



ZF Rane

Customer	Award Category
Ashok Leyland	Best Performance in Business Alignment-Gold
Isuzu Motors	Most Improved Supplier Award
Tata Motors	Best Supplier Award, Efficiency Award, Best in Class Award
Volvo Eicher	Best Supplier in NPD, Supply Chain, Uptime Excellence
Daimler India	Quality Appreciation Award
Renault Nissan	Best Supplier in Field Quality



Rane Brake Lining

Customer	Award Category
Brakes India	Best Supplier - Friction
Ashok Leyland	After Market Support Award
Foundation Brake	Business Excellence Award
Endurance	Gold Award for Quality Best Supplier Award, Consistent Vendor Rating Performance Award Capable Supplier Excellence in Technology upgradation



Rane NSK

Customer	Award Category
Maruti Suzuki	Efforts in Vendor Import Localisation
Honda Cars	Award for best reduction in CO2
Volvo Eicher	Quality Excellence
Daimler India	Best Technology Support

Rane Values

- › Provide superior products and maintain market leadership
- › Pursue excellence
- › Achieve the highest standard of ethics and integrity

Rane Approach

- › Build strong connections with customers to understand their challenges
- › Strategic investments to improve quality and productivity
- › TQM way of working
- › Emphasis on 'First-time right' policy

Rane Credentials

- › Modern manufacturing facilities with IATF 16949 certification
- › State-of-the-art product development and validation capabilities
- › Deming Grand Prize for 3 Rane companies
- › Deming Prize for 5 Rane companies



- › Technology collaboration with top global players



ZF Group, Germany
Hydraulic Power Steering Systems and Occupant Safety Systems



NSK, Japan
Energy Absorbing Steering Columns and Electric Power Steering



Nisshinbo Brake Inc., Japan
Brake Linings, Disc Pads and Clutch Facings

Value Proposition

- › Superior products driven by execution excellence
- › Trusted partner with shorter development lead times
- › Agile manufacturing process and scalable facilities
- › Provide system-level solutions with deep understanding of customer needs
- › With enhanced R&D capabilities, we provide light-weighting, improved safety and performance

**LONG TERM PARTNER OF CHOICE TO LEADING
AUTOMOTIVE COMPANIES AND TIER 1 SUPPLIERS**

An exciting workplace founded on the principles of values, fairness and transparency that:



Provides challenging assignments

Encourages learning

Enhances career opportunities



- › **Organisation Development Excellence Award** for the exceptional practices on **Leadership Development** by Transcendence, Tata Institute of Social Sciences (TISS), 2019
- › Recognized by International Federation of Training and Development Organizations in Best HRD practice category, 2018
- › Award for **Talent Management** from the Employer Branding institute, Singapore, 2012 & 2014
- › Significant Achievement in **HR Excellence**, CII, 2012



Certified as a **Great Workplace** by the Great Place to Work institute, 2023



Systems approach to deliver H&S to our employees

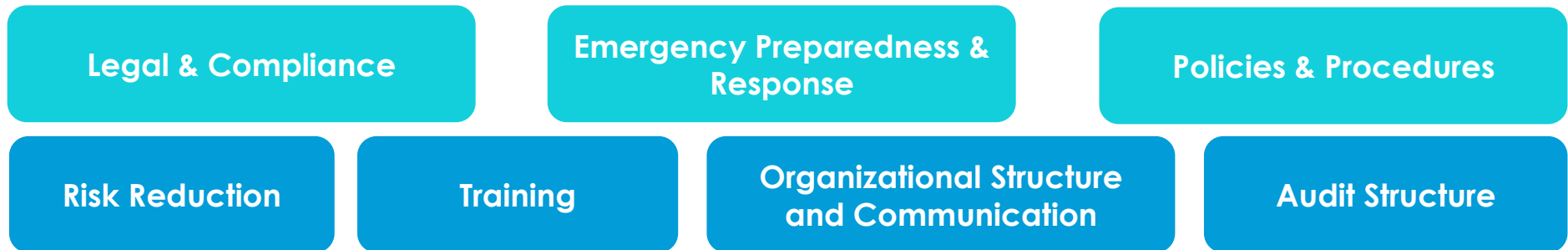

We create value through sustainable operations and optimal resource utilisation

Dimensions of Sustainability at Rane Group

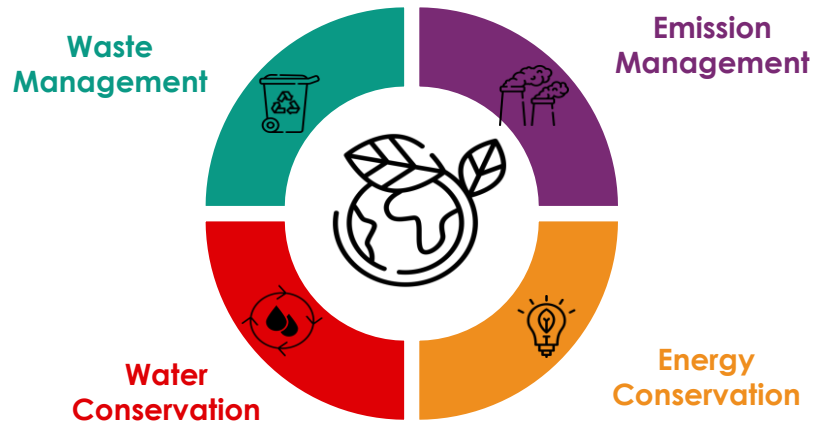

Recognition in Sustainability Excellence

- Rane Brake Lining - Puducherry won the CII National Award for Excellence in Energy Management
- Rane Brake Lining - Trichy received second prize for Environment Protection and Management by the Government of Tamil Nadu
- Rane NSK Steering Systems – Chennai won the CII National Award for Excellence in Energy Management
- Various facilities are certified by US green building council

Water Conservation

Water Positive is achieved through Rain Water Harvesting and Water Conservation Techniques



Energy Conservation



58.5 lakhs units
of power saved on
annualised basis in FY24



4,211 MT Tons
Reduction of Eq. Co2 emission

Transitioning to renewable energy



36% of power demand
met by Renewable Energy

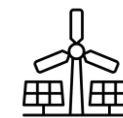

Reduction of 45,233 MT of Eq. Co2 savings compared to power from traditional sources

- › Rane Foundation (RF) is a **public charitable trust** founded by Rane's promoters in the year 1967
- › RF is the **main arm for Rane's Corporate Social Responsibility (CSR) initiatives** and is exclusively funded by the Rane companies
- › Initiatives are focused on **education, healthcare, environment and community development**

Rane Polytechnic



Education

- › Institution Development - Rane Polytechnic, Rane Vidyalaya
- › Vocational Training & Skill Development
- › Awareness programs



Healthcare

- › Nutrition program
- › Health camps
- › Medical infrastructure & aid



Environment

- › Plantation drives
- › Infrastructure for sustainability
- › Natural resource preservation



Community Development

- › Providing amenities & sanitation
- › Improving quality of life
- › Rural infrastructure development program

Rane Vidyalaya



Thank You

For further information, please contact:

investorservices@ranegroup.com or diwakar.pingle@in.ey.com

Rane Corporate Centre

"Maithri" 132, Cathedral Road,
Chennai - 600 086, India
www.ranegroup.com

Glossary of Abbreviations

Abbreviation	Expansion	Abbreviation	Expansion
ACMA	Automotive Component Manufacturers Association	NPD	New Product Development
AMP	Advanced Machining Processes	OE	Original Equipment
ATV	All-Terrain Vehicle	OEM	Original Equipment Manufacturer
bps	Basis point, 100 bps equal to 1%	OES	Original Equipment Supplier
BV	Book Value per share	OSD	Occupancy Safety Division
CII	Confederation of Indian Industry	PC	Passenger Car
CNG	Compressed Natural Gas	PV	Passenger vehicle
Cr	Crores	R&D	Research and development
CV	Commercial Vehicle	RBL	Rane Brake Lining Limited
ELR	Emergency Locking Retractor	REVL	Rane Engine Valve Limited
EOP	End of production	RHL	Rane Holdings Limited
EPS	Earnings per share / Electronic power steering	RML	Rane (Madras) Limited
EV	Electric vehicle	RNSS	Rane NSK Steering Systems Pvt Limited
FT	Farm Tractors	SCV	Small Commercial vehicle
FY	Financial Year	SE	Station Engine
HPDC	High Pressure Die Casting	SGD	Steering Gear Division
HR	Human Resource	TPM	Total Productive Maintenance
Intl	International	US	United States
JV	Joint Venture	USD	United States Dollar
LCV	Light Commercial Vehicles	UV	Utility Vehicle
LMCA	Light Metal Casting Inc., America	VRS	Voluntary Retirement Scheme
Ltd	Limited	YoY	Year-on-Year
M&HCV	Medium & Heavy Commercial Vehicles	ZRAI	ZF Rane Automotive India Pvt limited
M&M	Mahindra and Mahindra	2W/3W/4W	Two Wheeler/Three Wheeler/Four Wheeler

This presentation may contain certain forward looking statements concerning Rane's future business prospects and business profitability, which are subject to a number of risks and uncertainties and the actual results could materially differ from those in such forward looking statements. The risks and uncertainties relating to these statements include, but not limited to risks and uncertainties regarding fluctuations in earnings, our ability to manage growth, competition (both domestic and international), economic growth in India and the target countries for exports, ability to attract and retain highly skilled professionals, government policies and action with respect to investments, fiscal deficits, regulations etc., interest and other fiscal costs generally prevailing in the economy. The company does not undertake to make any announcement in case any of these forward looking statement become materially incorrect in future or update any forward looking statements made from time to time by or on behalf of the Company.