



Date: November 10, 2017

To, BSE Limited The Corporate Relationship Department, P J Towers, Dalal Street, Mumbai - 400 001. BSE Security Code: 533162	To, National Stock Exchange of India Limited Listing Department "Exchange Plaza" Bandra Kurla Complex Bandra (E), Mumbai – 400 051 NSE Trading Symbol: HATHWAY
---	--

Subject: Intimation of "Investor Presentation of the Company"

Dear Sir/Madam,

Please find enclosed the Investor Presentation setting out an overview of the Company. This information shall simultaneously be uploaded on the website of the Company i.e. www.hathway.com

This is for your information.

Thanking you,

FOR HATHWAY CABLE AND DATACOM LIMITED

AJAY SINGH

Head Corporate Legal, Company Secretary and Chief Compliance Officer

FCS: 5189

Encl: As Above

Hathway Cable & Datacom Limited

805/806, "Windsor", Off C.S.T.Road, Kalina, Santacruz (E), Mumbai - 400 098.

Regd. Off.: "Rahejas", 4th Floor, Corner of Main Avenue & V.P. Road, Santacruz (W), Mumbai - 400 054.

Email : info@hathway.net, Website : www.hathway.com

CIN No. L64204MH1959PLC011421

Hathway Cable and Datacom Limited

Investor Presentation – November 2017

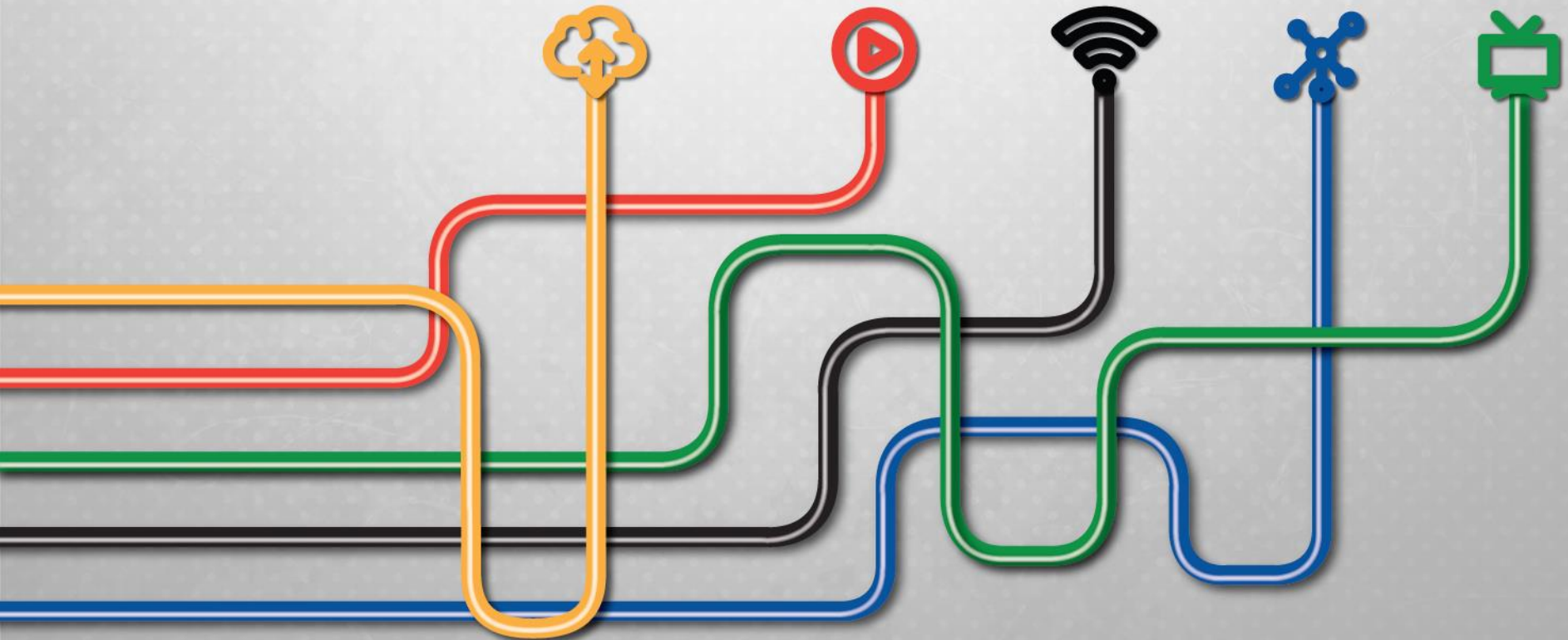

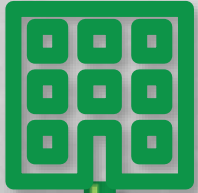

Company Overview

- Hathway Cable & Datacom Limited (Hathway) promoted by Raheja Group, is one of the largest Multi System Operator (MSO) & Cable Broadband service providers in India today.
- The company's vision is to be a single point access provider, bringing into the home and work place a converged world of information, entertainment and services.
- Hathway is listed on both the BSE and NSE exchanges and has a current market capitalisation of approximately INR 32.6 Bn as on 9th November, 2017.

Consolidated Revenue* (INR Mn) & EBITDA Margin (%)

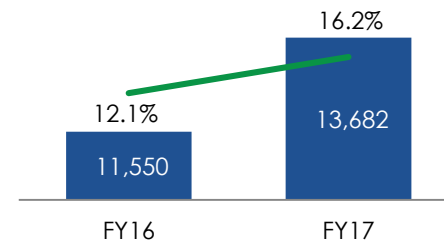

Broadband

- Hathway holds a PAN India ISP license and is the first cable television services provider to offer broadband Internet services
- Approximately 4.8 Mn two-way broadband homes passed
- Total broadband Subscribers – 0.7 Mn
- High-speed cable broadband services across 12 cities (4 metros and 3 mini metros)
- More than 52% share of the total MSO cable broadband market in India

Cable Television

- One of India's largest MSO, across various regions of the country and transmitting the same to LCOs or directly to subscribers
- Extensive network connecting 7.5 Mn cable television households and 7.2 Mn digital cable subscribers
- Offers cable television services across 350 cities and major towns
- 15 in-house channels and 10 Value Added Service (VAS) channels

FY17 Operational Revenue Break-up

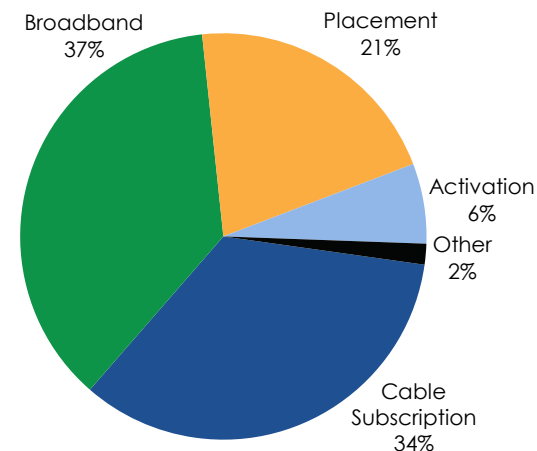

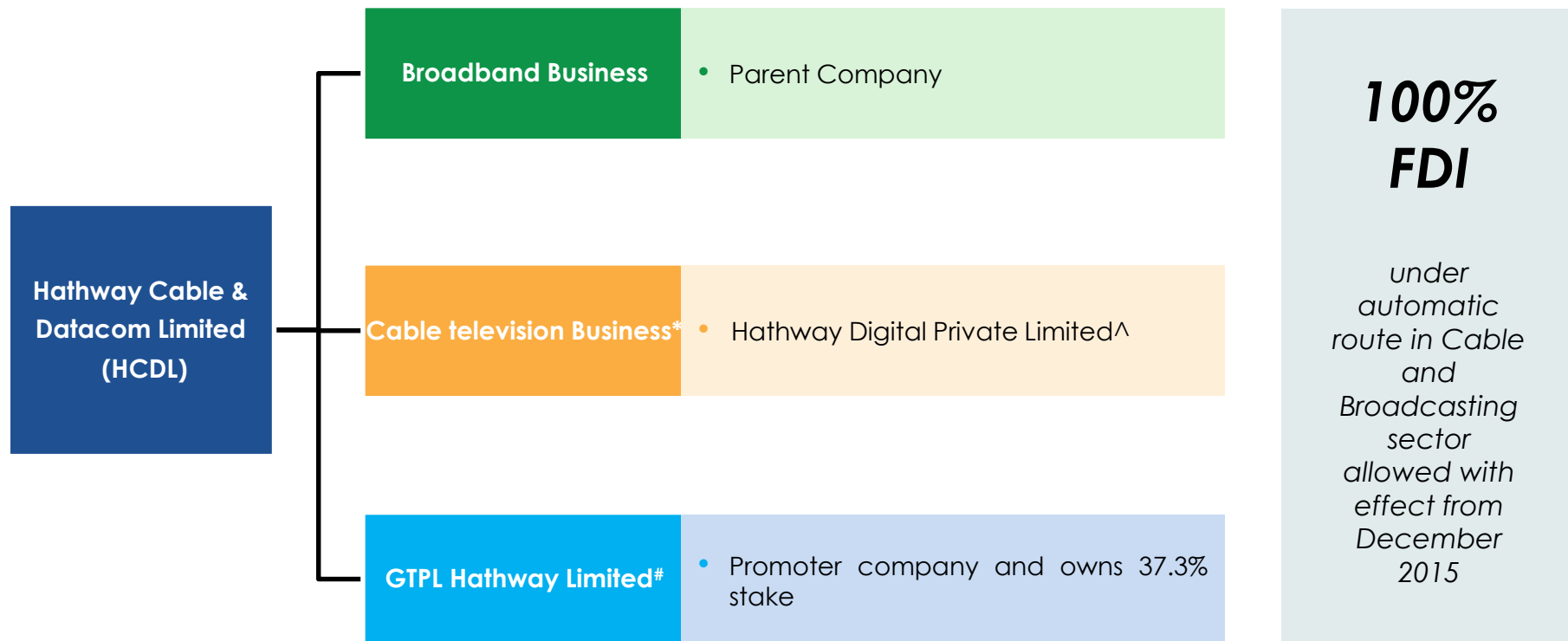



Objective

Build Value for all stakeholders in the Value chain

Differentiated customer experience



Trendsetter in broadband industry on speed, GBs, Price & Value For Money equation



Leverage broadband and Cable Television presence to give differentiated content, services and applications

Investment for growth



Increase broadband subscriber base by increasing penetration in existing geographies



Leverage Cable Television network for Broadband business for accelerating sub growth

Transform costs



Cost Leadership

- Shared services model
- Automation
- Centralization / outsourcing



- Best in class consumer/LCO user interface in Cable Television industry
- New tariff order optimize content cost

Broadband



53.2%

YoY Annual Revenue growth
INR 4,955 Mn



16.8%

3 Year CAGR in ARPU Growth
INR 717



33.9%

3 Year CAGR of Broadband homes passed and presence in 12 cities (4 metros and 3 mini metros)
4.8 Mn



28.6%

3 Year CAGR of Broadband subscribers
0.7 Mn



200 MBPS

Maximum speed offered to its customers
Average of 60 MBPS



Upto 1 TB

Data offered with average consumption of
98 GB
Per month / per subscriber

Cable TV



24%

YoY Annual Revenue growth of CATV Subscription
INR 4,728 Mn



7.5 Mn

Cable Universe in 13 states



96%

% of Digital Cable subscribers
7.2 Mn STBs



350+

Presence in cities and major towns



31,000 Kms

Fibre cable network



193K

HD Subscribers

Board members

Sridhar Gorthi

Chairman & Independent Director

Rajan Raheja

Non-executive Director

Akshay Raheja

Non-executive Director

Viren Raheja

Non-executive Director

Vinayak Aggarwal

Non-executive Director

Sasha Mirchandani

Independent Director

Devendra Shrotri

Independent Director

Ameeta Parpia

Independent Director

Rajan Gupta

Managing Director

Experienced management team with strong track record

Rajan Gupta – *Managing Director* – IIM Bangalore alumni with over 20 years of experience in blue chip companies. Worked with Asian Paints, Coca Cola and Tata Tele Services in leadership role.

Vineet Garg – *CFO* – Chartered Accountant with over 23 years of experience in organisations like Idea Cellular, Loop Mobile, Tata Teleservices and Reliance Communications. Worked in leadership roles in areas of revenue assurance, system design, process reengineering and finance & controllership.

Rajaraman S – *COO – Video Business* – Chartered Accountant with over 19 years of experience of which 15 years have been spent in the Media and Entertainment space with leading global media companies like 21st Century Fox, NBCU.

Vivekanand Tripathi – *CIO* – Professional experience of 17 years with organizations like Infosys, Max Life, Aegon Life Insurance covering industries like IT and Insurance.

Ajay Singh – *Head-Legal, Company Secretary & Chief Compliance Officer* – A Company Secretary and MBA (Finance) with professional experience of 22 years across sectors like Telecom, ICT, Manufacturing and Real Estate. Worked across areas such as legal, secretarial, finance, treasury operations, project and risk management.

Ruzbeh Jaorewalla - *CTO, West & North* – Industry veteran with more than 30 years of experience specialising in setting up and managing headends and networks for Cable TV & Broadband. Actively involved in setting up the first dish antenna in the country for receiving satellite transmission for Cable TV networks. Earlier worked with Business India Television & Star TV.

S.Naga Kishore - *CTO, South & East* – B.E. in Electronics and Telecommunications and an MBA with extensive experience of over 25 years with organizations like Tata Teleservices Ltd, Idea cellular. Proficient in wireless, transmission and wire line technologies and diversified functions like planning, implementation, operations and customer service management.

Sarathy.KK – *Chief Customer Service Head* – An MBA with professional experience of 24 years having worked in organisations like RPG Enterprises, Bharti Airtel, and Tata Teleservices, specialising in areas of Collections, Call Centre Management, Process Reengineering and Quality, using Six Sigma standards.

Key Milestones

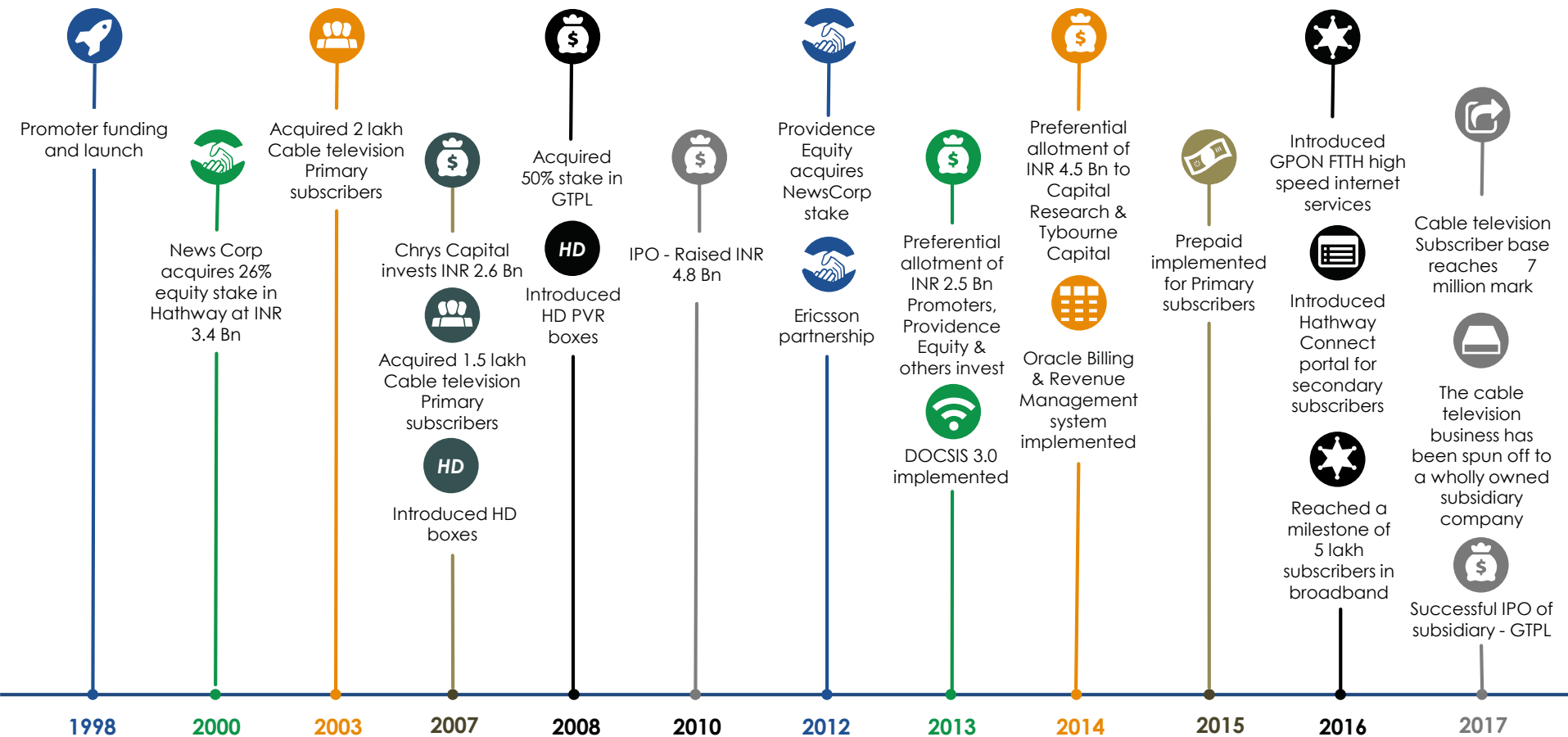

Strong market share in important regional cable markets in India

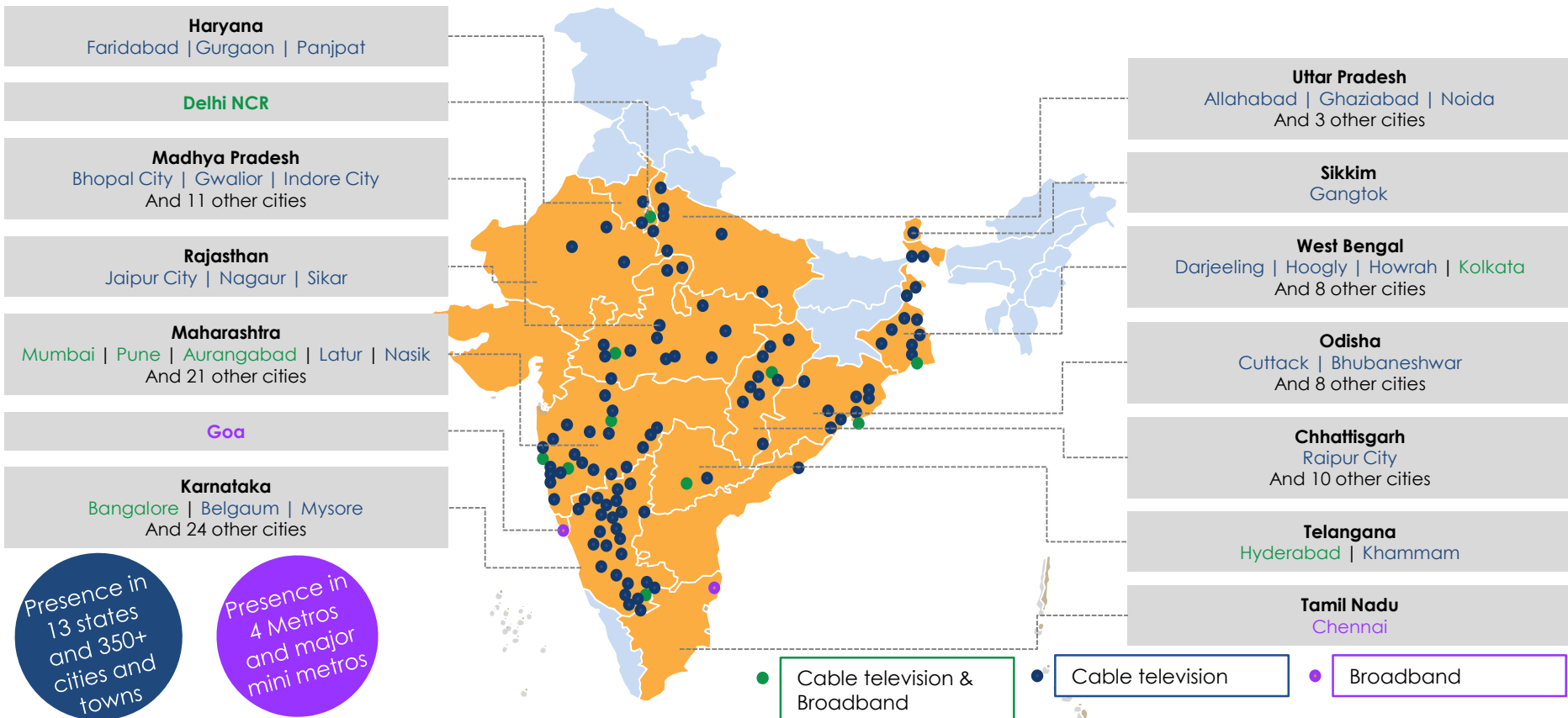

Presence in 13 states and 350+ cities and towns

Presence in 4 Metros and major mini metros

- Cable television & Broadband
- Cable television
- Broadband

Advanced technology and equipment provided by leading technology vendors

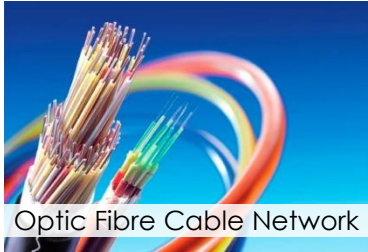

Optic Fibre Cable Network

- Overground: 27,000 Kms
- Leased: 4,000 Kms
- Underground: 500 Kms



Digital Headends

- 6 Primary Headends and 7 Secondary Headends



GPON Technology

- Broadband speed upto 1 Gbps
- Passive Network (No Power)
- VoD, OTT capabilities

Leading Technology Vendors

STBs (SD & HD)



Head-ends/
Compression



Modems



GPON



CAS







NOC & OSS



ERP & Billing
System



Awards and Accolades

Year	8 Times	2011	2013	2015	2015	2016	2016	2017
Organized by	Indian Telly Awards	Star News Brand Excellence Awards	Euromoney	Aavishkar Media Group	Economic Times Best Tech Brand Award	Aavishkar Media Group	LACP Vision Awards	Aavishkar Media Group
Category	Quality Cable TV and Broadband Internet Services	Brand Excellence in Digital Products for Internet Services	Best Managed Media Companies in Asia	Most Outstanding MSO Broadband Service Provider And Best MSO of the Year	Contributing Significantly to the growth of Digital Cable Television in the country	Best MSO for Broadband Business And Most Outstanding National MSO	Silver Award for Excellence in Annual Report development in its Industry	Best MSO for Broadband Business
Award								

Strong Market Share in regional cable markets in India

GUJARAT

#1
MSO in Gujarat

67%
Market Share

~4.2 Mn
Box seeded

Cable television
& Broadband
services

KOLKATA & HOWRAH

#2
MSO in Kolkata
& Howrah

24%
Market Share

~1.9 Mn
Box seeded in
West Bengal

Cable TV
services

GPL Code
NSE: GPL
BSE: 540602

HCDL Holds
37.3% stake in
GPL

Key Highlights

Q2-FY18

Present in 189+ towns across 10 states

Cable Subscriber Universe

8.3 Mn

Digital Cable Subscribers

7.1 Mn

In Phase III / IV areas

4.8 Mn

Broadband Homes Passed

1.2 Mn

Total Broadband Subscribers

0.3 Mn

Key Financials (Ind-As) (INR in Mn)

FY17
Conso

FY17
Standalone

H1-FY18
Standalone

Revenue from
Operations

INR 9,417

INR 6,380

INR 3,617

EBITDA

INR 2,404

INR 2,002

INR 1,155

Profit for the Year

INR 400

INR 401

INR 267

Advanced technology and equipment provided by leading technology vendors



Optic Fibre Cable Network

- Overground: 5,406 KMs
- Underground: 600 KMs
- Leased: 3,480 KMs



Digital Headends

- Main: 2 headends
- Support: 4 Headends



GPON Technology

- Seamless connectivity
- Higher broadband speed
- VoD, OTT capabilities

Leading Technology Vendors



Comparable Revenue (INR in Mn)

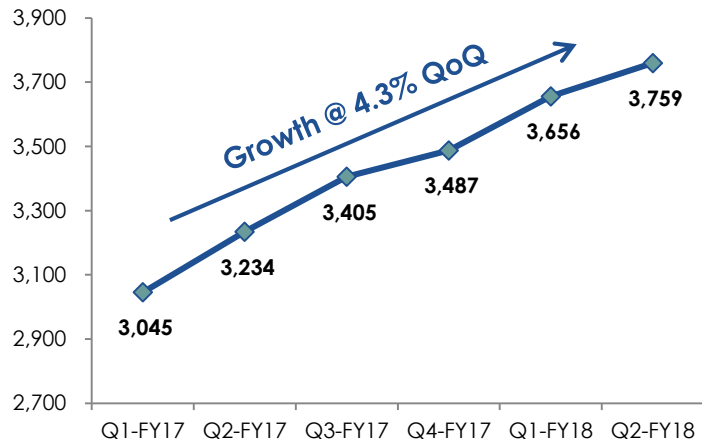

Comparable EBITDA (INR Mn)

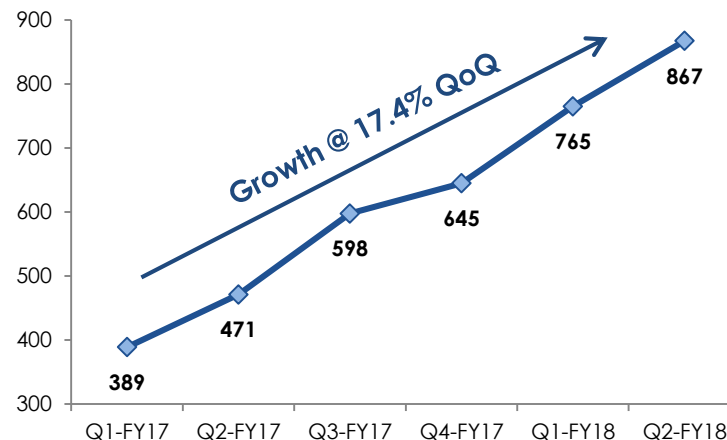

Hathway Cable and Datacom Limited (HCDL) opts to disclose only the standalone results to the stock exchanges as mandated under the SEBI (Listing Obligations and Disclosure Requirements) Regulations. In view of the transfer of CATV Biz to Hathway Digital Private Limited (HDPL), management of HCDL presented the above clubbed numbers of HCDL and HDPL merely to facilitate a high-level comparison of quarterly numbers to its board. The clubbed numbers of HCDL and HDPL are based on the standalone financial statements of each of HCDL and HDPL respectively. The numbers of HCDL have been reviewed by its audit committee and statutory auditors. The numbers of HDPL have been approved by its board. No material deviation is expected in the clubbed numbers.



Broadband Business

- Hathway holds a "Category-A" PAN India ISP license and was the first cable television services provider to offer broadband Internet services.
- The company is India's largest cable broadband services provider, with ~ 4.8 Mn two-way broadband enabled homes.
- Broadband subscribers comprise of domestic households and corporate subscribers.
- The Broadband segment is a completely B2C where Hathway manages the entire value chain – from marketing, sales, customer service, billing and collection, call centre and technical compliance.
- Hathway holds 52% market share of the total MSO cable broadband market in India.
- Hathway pioneered the launch of high-speed 50 MBPS plans in India, using DOCSIS-3.0 technology in partnership with CISCO and upto 200 MBPS plans using FTTH technology in partnership with ZTE.
- The Marketing campaign of Hathway led by "R Madhavan".

Consolidated Broadband Revenue (INR Mn)

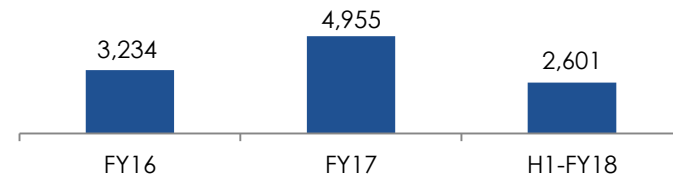

Consolidated Homes Passed & Subscribers

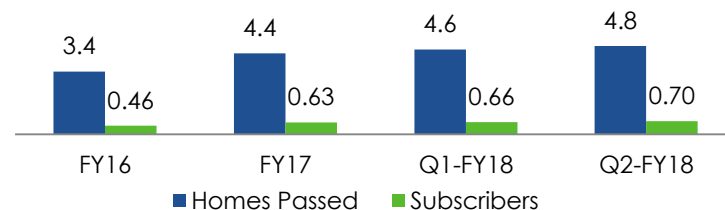

Consolidated ARPU (INR)

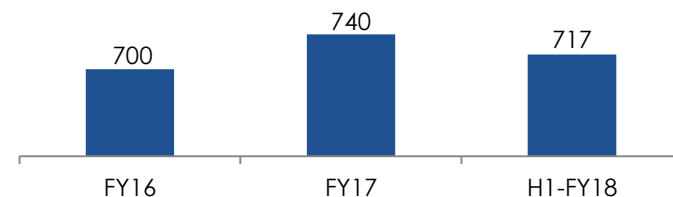

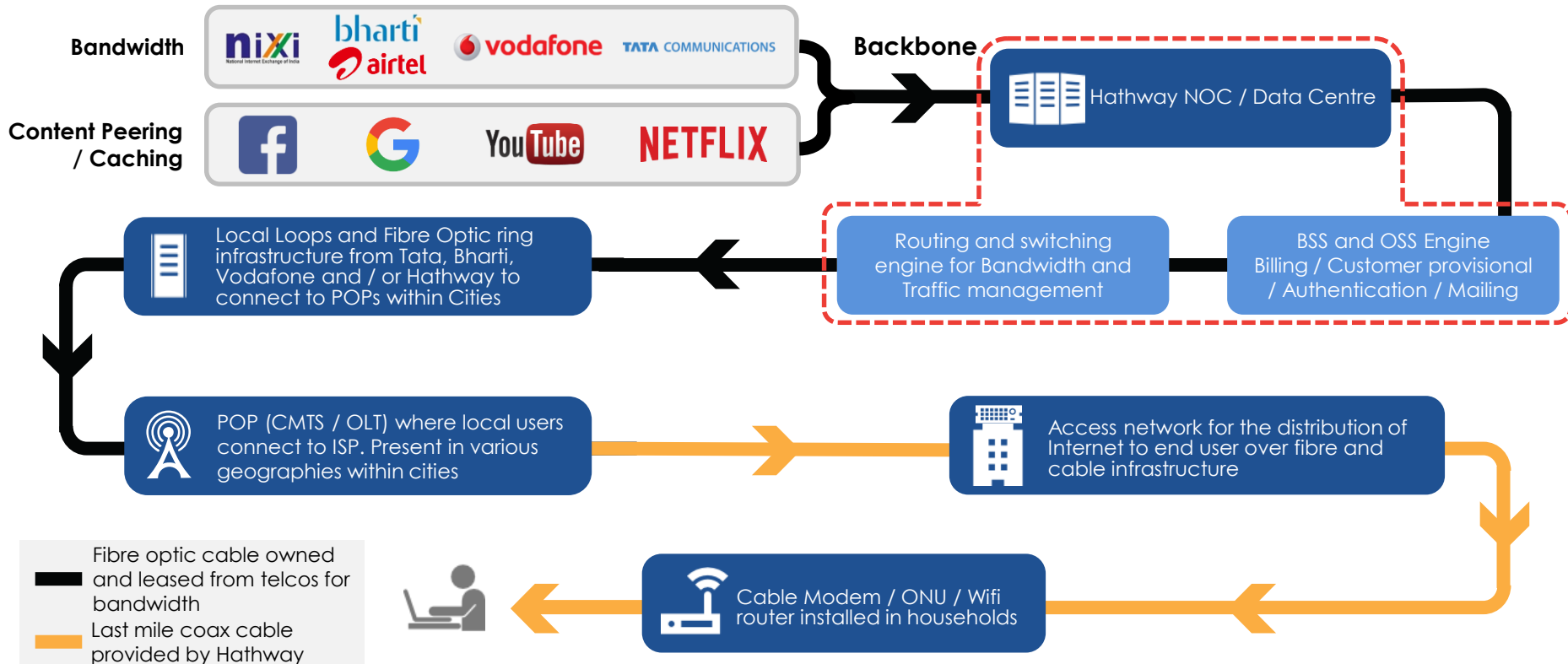

NAP – Network Access Point	POP – Point of Presence	CMTS - Cable Modem Termination System	NOC - Network Operations Centre
OLT – Optical Line Transmitter	ONU – Optical Node Unit	BSS – Business Support System	OSS – Operational Support System



Technology / Infrastructure

- DOCSIS 3.0 and 3.1 – pioneers in launching high-speed 100 Mbps broadband.
- GPON Fibre to home – capability to offer speeds upto 1 Gbps
- 4.8 million “Home Pass” in major metros.
- Adoption of Oracle billing & revenue management system ERP and other customer interface.



LCO partnership

- Excellent coordination between Broadband and Cable on ground teams, co-creating expansion plans.



Customer / Service

- R Madhavan as brand ambassador
- Partnering with various content providers, education portals and other lifestyle improvement players
- Self care app “Hathway Broadband” has been launched to provide customer to access their data usage pattern, billing cycle and make online payments
- In Partnership with Microsoft 1 TB cloud storage being given free to all yearly pay term consumers.



Content Tie up

- Collaborative venture between Hathway and Yupp TV providing a host of customer centric services



Final Output

Maximum speed is up to
200 Mbps

Subscribers increased from
0.42 Mn in 2013 to
0.70 Mn in Q2-FY18

ARPU increased from
INR 350 in 2013 to
INR 717 in Q2-FY18

Monthly ARPU
>INR 770 from
new subscribers

Average monthly usage
per subscriber has
increased from **30 Gb**
in FY16 to **98 Gb** in
Q2-FY18

Revenue (INR)

Particulars	INR / Unit	%
Consumer Price	826	118%
GST	126	18%
NET REVENUE	700	100%

Cost (INR)

Particulars	INR / Unit	%
Break-up of Cost		
Bandwidth and leaseline cost	63	9%
Commission	70	10%
Call centre and Network maintenance	21	3%
Marketing & Advertisement	21	3%
Fixed Cost	245	35%
TOTAL COST	420	60%

Particulars	INR / Unit	%
EBITDA	280	40%

Investment per Subscriber (INR)

Particulars	INR / Unit
Cost per Home Pass	600
Penetration	20%
Home Pass capex per subscriber	3,000
Last mile Capex (Per subscriber)	1,300
CPE (Wi Fi Modem)	1,600
NOC Capex	1,600
Capital Cost per subscriber	7,500

Payback period = ~28 months

Capital cost/ EBITDA per unit

Assumption:
Home pass capex per subscriber penetration is 20%

Quarterly HCDL Income Statement



Income statement (INR Mn)	Q2-FY18	Q1-FY18	Q-o-Q Growth	H1-FY18
Subscription Broadband	1,311	1,290	2%	2,601
Other Non operational income [#]	59	9	556%	68
Total Income	1,370	1,299	5%	2,669
Employee Cost	105	89	18%	194
Other Expenses	667	710	-6%	1,377
Total Expenditure	772	799	-3%	1571
EBITDA	598	500	20%	1,098
EBITDA %	44%	38%	600 bps	41%
Depreciation / Amortization	243	226	8%	469
Finance Cost	202	172	17%	374
PAT before exceptional item	153	102	50%	255
Add: Exceptional Items - Profit on offloading of GTPL Shares	-	171	NA	171
PAT	153	273	-44%	426
FX (Gain) / Loss	13	2	NA	15
Other Comprehensive Income / (Loss) (Net of Tax)	-	-3	NA	-3
Total Comprehensive Income	140	274	-49%	414

* Q2 FY17 financials are not added as these numbers are not comparable. [#]Non-operational income includes Rs. 4 Crores dividend received from GTPL Hathway Limited.

Half Yearly HCDL Balance Sheet

Statement of Assets and Liabilities (INR Mn)	Standalone	
	As on 30.09.17	As on 31.03.17
1. Shareholder's Funds		
a. Equity Share Capital	1,661	1,661
b. Other Equity	8,528	8,114
Sub Total – Shareholder's funds	10,189	9,775
2. Non-current liabilities		
a. Borrowings	5,451	5,862
b. Other Financial and non-current Liabilities	176	192
Sub Total – Non – current liabilities	5,627	6,054
3. Current liabilities		
a. Trade Payables	383	473
b. Other Financial Liabilities	3,536	3,539
c. Provisions and other current Liabilities	1,360	1,173
Sub Total – Current liabilities	5,279	5,185
TOTAL – EQUITY AND LIABILITIES	21,095	21,014
1. Non-current assets		
a. Property, Plant, Equipment & Tangibles	7,456	6,886
b. Investments	10,897	8,332
c. Loans & other financial assets	324	290
d. Other non-current assets	634	670
Sub Total – Non – current assets	19,311	16,178
2. Current assets		
a. Inventories	208	201
b. Trade Receivables	318	242
c. Cash and Cash equivalents	23	138
d. Loans & other financial assets	532	3,492
e. Current Tax Assets (Net)	270	234
f. Other Current Assets	433	529
Sub Total –Current assets	1,784	4,836
TOTAL - ASSETS	21,095	21,014



Cable Television

- Hathway offers its cable television services across 350+ cities and major towns, operating in geographical regions which constitute important markets for advertisers and broadcasters.
- Hathway is one of India's largest Multi System Operator (MSO), operating on several head ends across various regions of the country and directly downloading content from broadcasters and transmitting the same to LCOs or directly to subscribers.
- Hathway has a total digital base of 7.2 Mn subscribers - out of this, the company has 0.35 Mn primary subscribers and remaining 6.9 Mn secondary subscribers managed through LCOs.
- It has been one of the early proponents and adopters of digitisation, and one of its early beneficiaries.
- The company also generates revenue through advertisement spots on In-House channels and various STB Properties.
- Hathway has won 17 awards including Best MSO of the year and Outstanding MSO providing "Technology and Service" under Distribution sector, by the Avishkar Media Group.

Consolidated Total Cable television Revenue (INR Mn)

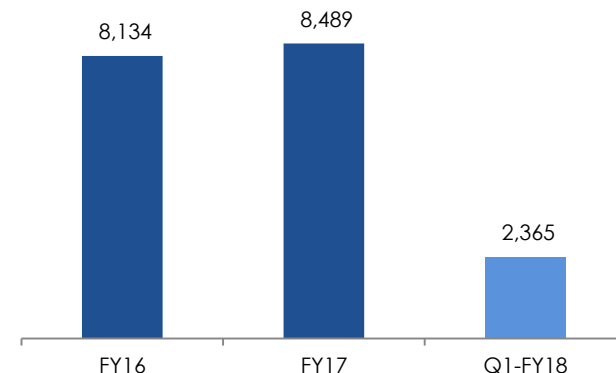

Consolidated FY17 Total Cable television Revenue Breakup (INR Mn)

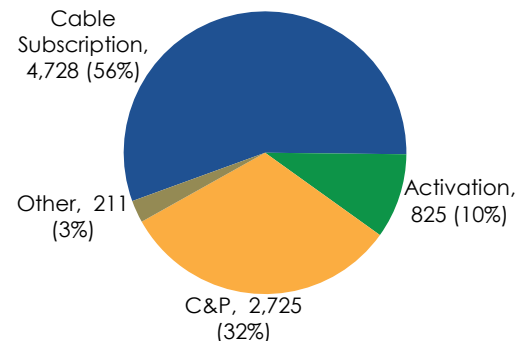

Cable television Subscribers (Mn)

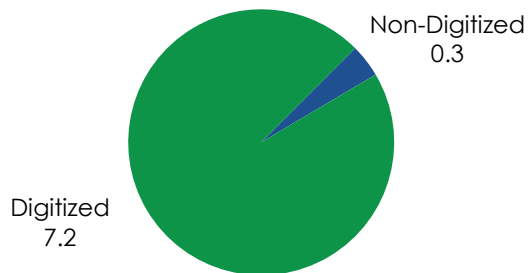

Cable television STBs (Mn)

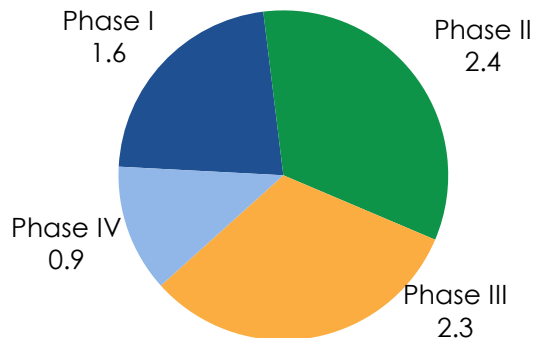

Cable television Exit ARPU (INR)

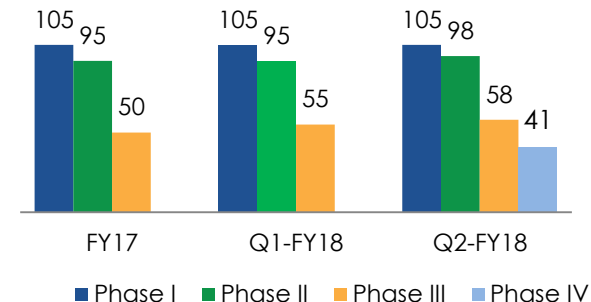

Dominant Market Share in Key Geographies

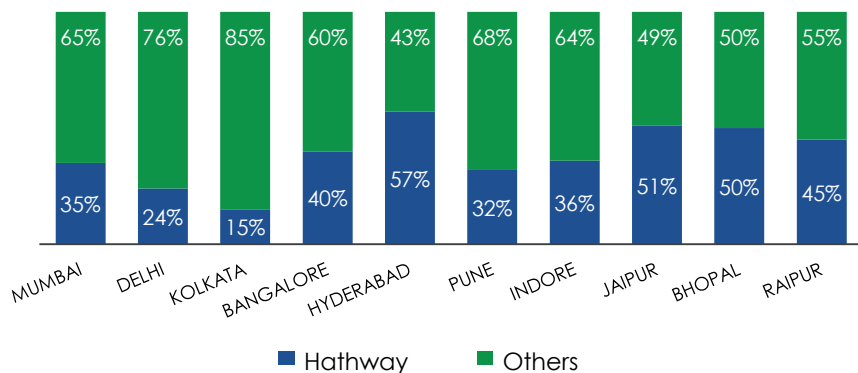

HD Subscribers ('000)

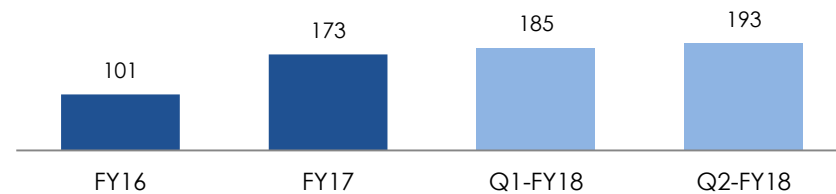

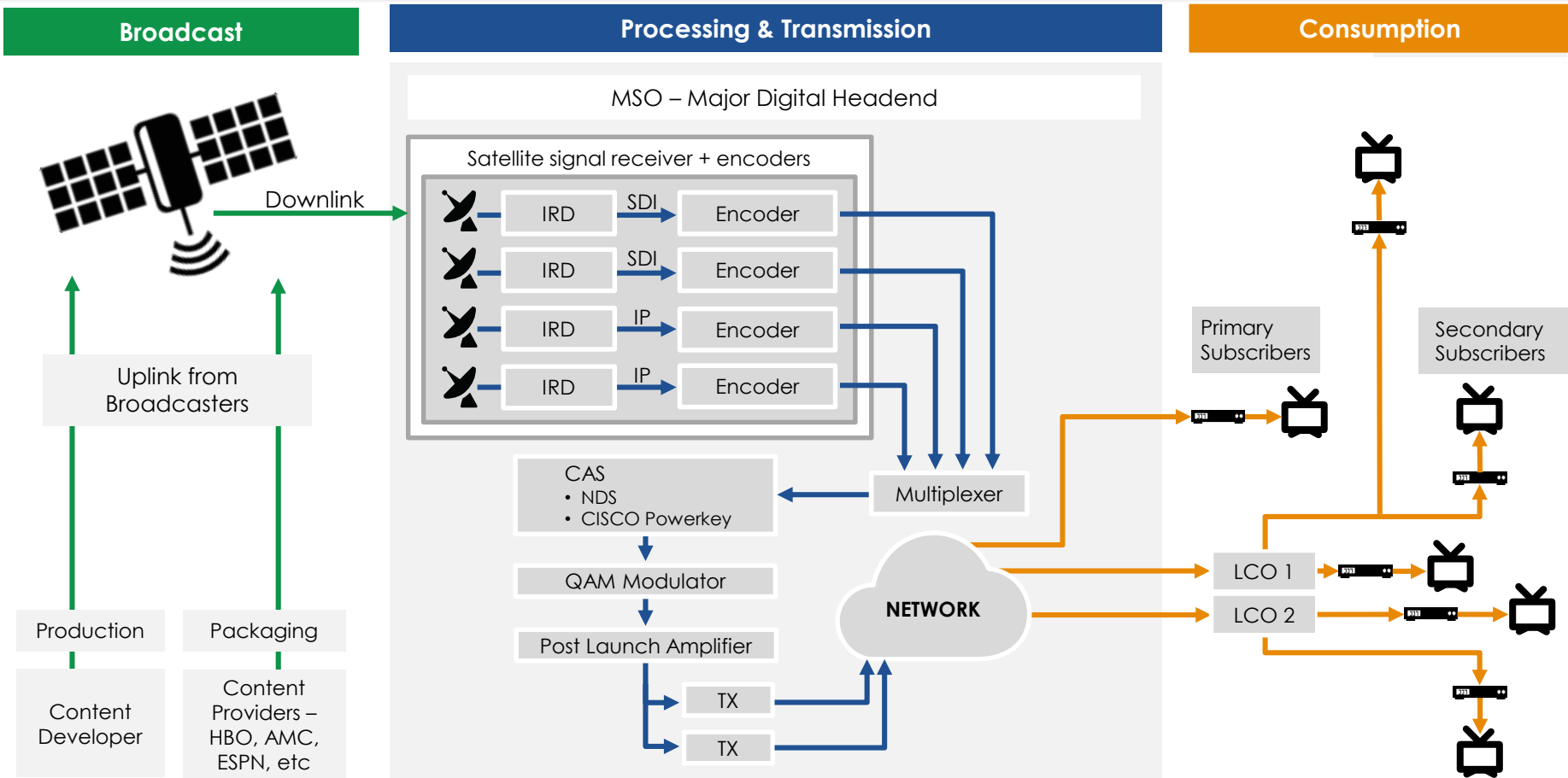



Technology / Infrastructure

- Hathway Connect enables LCOs to manage their network independently & transparently.
- Subscribers can access their accounts on the Mobile app as well as web platform.
- Regional head-end base architecture provides feed from 6+ headends across the country.
- Centralized Conditional Access System (CAS) from CISCO (NDS) and STBs by Skyworth.



LCO partnership

- Providing training and support to LCOs.
- Uniform commercial policies
- Strong relationships.



Customer / Service

- Offering innovative packages as per regions served.
- Enhanced content offering – 50+ HD channels.
- Pre-paid services for primary subscribers.
- Unique electronic programme guide (EPG).



Hathway's Existing channel Portfolio

- | <u>In-house Channels</u> | <u>VAS Channels</u> |
|--------------------------|---------------------|
| • DJ Channel | • Ibaadat |
| • Hathway movies | • Insync |
| • Hathway entertainment | • Comedywalas |
| (12 other channels) | • Yipee |
| | (6 other channels) |

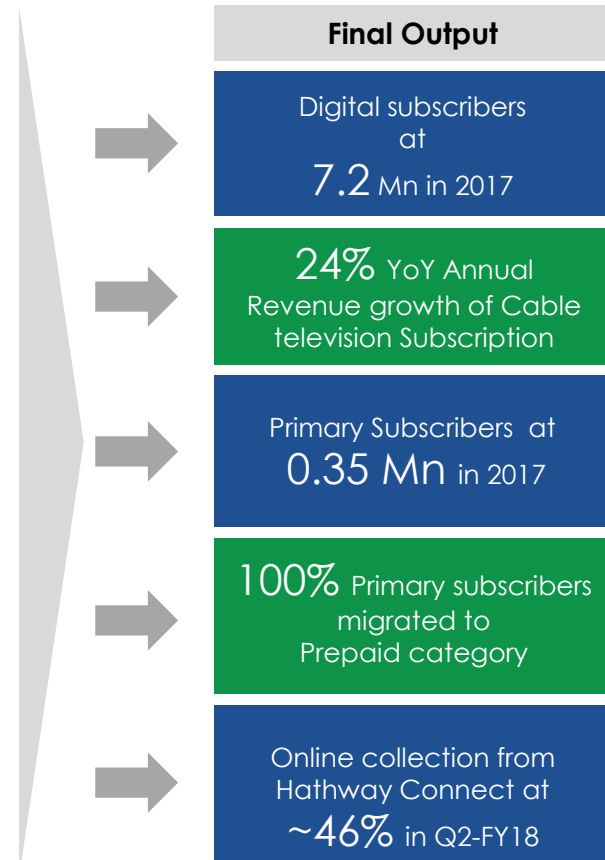

Present Scenario Estimate

Particulars	Phase I & II	Phase III & IV
	INR / Unit	INR / Unit
Consumer Price	295	170
GST *	45	25
NET REVENUE	250	145
MSO Economics		
Share to MSO	100	50

Cost (INR)

Particulars	INR / Unit	INR / Unit
Net Content Cost	48	28
Customer Service	5	5
Fixed Over Heads	35	25
Particulars		
EBITDA	12	(8)

TRAI's new tariff order

- TRAI's proposed regulatory changes on tariff may drive structural change in the entire value chain (Broadcaster – Distributor – Consumer).
- **Broadcasters** with strong franchise will benefit from higher subscription and ad revenue.
- **Distributors'** business model will be largely de-risked, given stable revenue (distribution charge from consumers and content commission from broadcasters) and content cost becoming pass-through.
- **Content producers** will benefit, given broadcasters' increase thrust to create 'pull content' to attract viewers.

Key impediments

- On-ground execution remains the herculean task of customizing channels for each subscriber, customised packaging will have to be done by distributors to ensure smooth transition.
- Revenue sharing arrangements between MSO-LCOs needs to be ironed out.
- Push-back from broadcasters may result in elongated legal tussles, delaying its implementation or may result in significant alteration to regulations.

De-risked business model = Steady revenues from consumers / broadcasters + limited fixed overheads (content cost to be pass through) + higher bargaining power with broadcasters

Key Provisions

- Distributors can charge a maximum INR 130 (ex taxes) per sub per month as network capacity fee
- Maximum amount of INR 20 per sub per month for each additional lot of 25 SD FTA channels
- Broadcasters are permitted to offer a minimum of 20% distribution commission
- In case of arriving at a SIA, MSO and LCO share of service charges, network capacity fee and distribution fee shall be split in the ratio of 55:45

Impact on MSO

- Allows for complete pass through of pay channel costs from broadcasters directly to end subscribers
- Network capacity fee is expected to contribute to distributor's revenue
- Mechanism in place to settle fee-share related disputes with LCOS

Particulars	Present	New Tariff order
Content, Carriage & Placement	<p>Bundled Price for bouquet of channels with discount up to 90% on a-la-carte RIO Price of individual channels.</p> <p>Arbitrary increase in price of Content every year.</p> <p>Carriage & Placement - Negotiated based on DPO market share & market relevance for the broadcaster.</p>	<p>Channels will be offered at a-la-carte price (MRP) decided by Broadcaster, bouquet of channels will be sum total of a-la-carte price at nominal discount.</p> <p>DPO will get margin on MRP any increase in price will be passed on to consumer.</p> <p>Carriage payouts are prescribed.</p>
Customer Price	DPO decides Consumer Price, due to bundled deal, all channels are passed on the consumer with limited packages, resulting in wide variance in consumer price.	Consumer price prescribed as network access fees & Pay channel priced at MRP. This bring symmetry of consumer price across Platforms.
Cost	Bundled pricing results in limited packaging option. DPO can manage operation with basic SMS generally with couple of tariff plans.	Requires sophisticated SMS to manage high volume of al-a-carte choice to all subscribers. This may have cost implication to DPO who do not have required systems.
Cost of Swap of a STB*	Fixed cost model encourage subsidy on incremental STBs.	Variable cost model will be deterrent to subsidy on STBs.

Quarterly HDPL Income Statement



Income statement (INR Mn)	Q2-FY18	Q1-FY18	Q-o-Q Growth	H1-FY18
Subscription CATV	1,401	1,325	6%	2,726
Placement	740	702	5%	1,442
Activation	258	242	7%	500
Other operating income	50	96	-48%	146
Total Income	2,449	2,365	4%	4,814
Pay Channel Cost	1,385	1,352	2%	2,737
Employee Cost	219	214	2%	433
Other Expenses	514	527	-2%	1,041
Total Expenditure	2,118	2,093	1%	4,211
EBITDA	331	272	22%	603
EBITDA %	14%	12%	200 bps	13%

* Q2 FY17 financials are not added as these numbers are not comparable.



Financials

Historical Income Statement as per Ind-AS

Income statement (INR Mn)	FY17	FY16	Y-o-Y	FY17	FY16	Y-o-Y
	Standalone			Consolidated		
Cable television Subscription	4,515	3,842	17.5%	4,728	3,804	24.3%
Broadband Revenue	4,803	3,066	56.6%	4,955	3,234	53.2%
Placement	2,714	3,220	-15.7%	2,725	3,220	-15.4%
Activation	825	618	33.5%	825	834	-1.1%
Other Income	448	463	-3.2%	449	458	-2.0%
Total income	13,305	11,209	18.7%	13,682	11,550	18.4%
Pay Channel Cost	4,185	3,692	13.4%	4,717	4,336	8.8%
Employee Cost	865	796	8.7%	932	862	8.1%
Other Expenses	5,651	4,801	17.7%	5,823	4,961	17.4%
Total expenditure	10,701	9,289	15.2%	11,472	10,159	12.9%
EBITDA	2,604	1,920	35.6%	2,210	1,391	58.8%
EBITDA margin %	19.6%	17.1%	250 Bps	16.2%	12.1%	410 Bps
Depreciation	3,008	2,545	18.2%	3,058	2,589	18.1%
Finance cost	1,103	895	23.2%	1,108	898	23.3%
Exceptional items	34	363	-90.6%	7	174	-95.9%
Share of Profit/(Loss) of Associates	-	-	-	30	110	NA
PBT	-1,541	-1,883	NA	-1,933	-2,380	NA
Tax	-	-	-	-3	-3	0.0%
PAT	-1,541	-1,883	NA	-1,930	-2,377	NA
PAT margin %	-11.6%	-16.8%	520 Bps	-14.1%	-20.6%	650 Bps
Other comprehensive income/ (loss)	-3	-28	NA	-3	-29	NA
Total comprehensive income	-1,538	-1,911	NA	-1,927	-2,405	NA
EPS	-1.86	-2.27	NA	-2.32	-2.86	NA

Historical Balance Sheet as per Ind-AS

Statement of Assets and Liabilities (INR Mn)	Standalone FY17	FY16	Consolidated FY17	FY16
A. Equity and Liabilities				
1.Shareholder's Funds				
a. Share Capital	1,661	1,661	1,661	1,661
b. Reserves and Surplus	8,114	9,652	7,293	9,227
Sub Total – Shareholder's funds	9,775	11,313	8,954	10,888
2. Minority Interest	-	-	9	12
3. Current & Non-current liabilities				
a. Long-term and Short-term borrowings	6,286	11,695	10,650	11,727
b. Trade payables – Long & Short	473	1,466	1,763	1,777
c. Other Liabilities	4,480	8,906	12,762	9,144
Sub Total – Current & Non – current liabilities	11,239	22,067	25,175	22,648
TOTAL – EQUITY AND LIABILITIES	21,014	33,380	34,138	33,548
B. Assets				
1. Non-current assets				
a. Fixed Assets	6,730	16,295	16,896	16,541
b. Goodwill and other intangible Asset	156	934	1,869	1,806
c. Long term loan and advances	109	317	9	245
d. Other non-current assets	9,183	10,286	8,915	9,217
Sub Total – Non – current assets	16,178	27,832	27,689	27,809
2. Current assets				
a. Trade Receivables	242	2,931	3,451	2,859
b. Cash and bank balances	138	272	509	416
c. Other current assets	4,456	2,345	2,489	2,464
Sub Total –Current assets	4,836	5,548	6,449	5,739
TOTAL - ASSETS	21,014	33,380	34,138	33,548

Standalone Revenue (INR Mn)

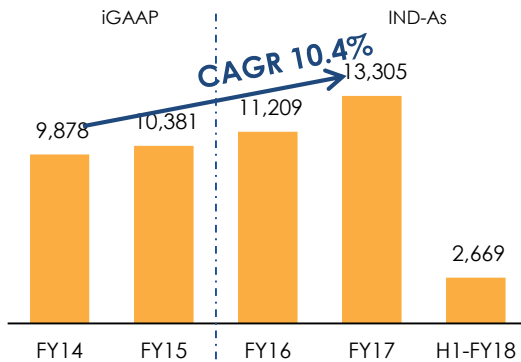

Standalone EBIDTA & Margins (INR Mn)

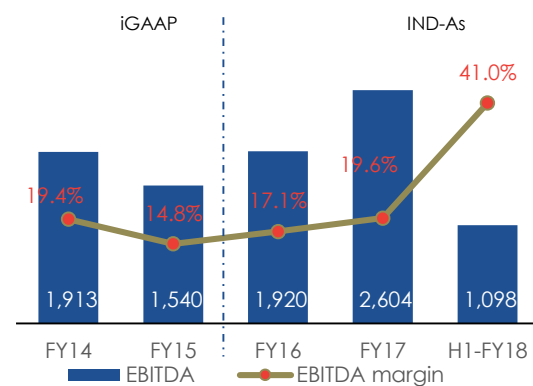

Consolidated Revenue (INR Mn)

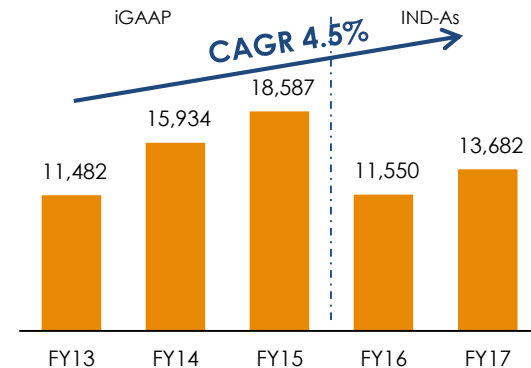

Standalone Network (INR Mn)

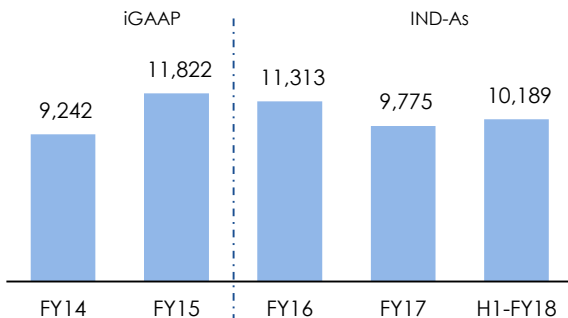

Standalone Gross Additions of FA (INR Mn)

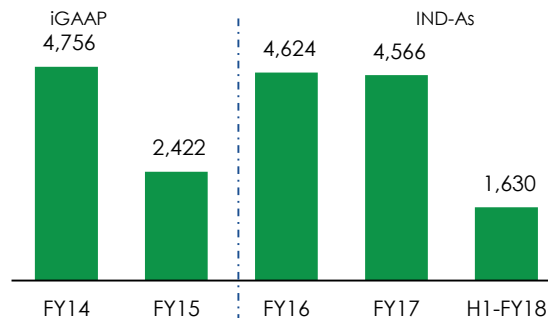

Consolidated EBIDTA & Margins (INR Mn)

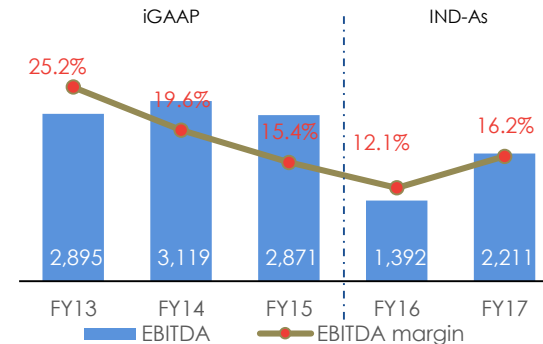

Share Price Performance

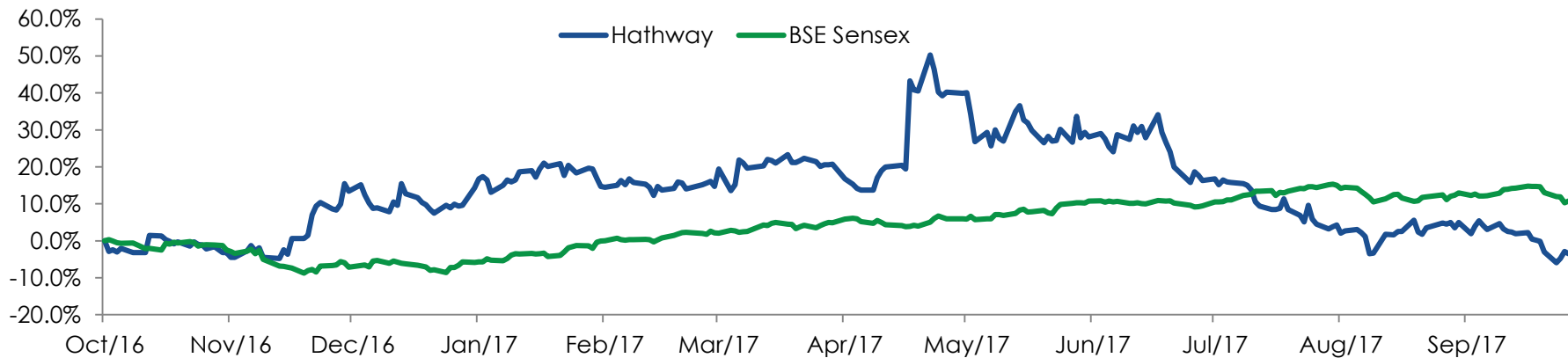

Price Data (30th SEPTEMBER, 2017)

INR

Face Value	2.0
Market Price	30.55
H/L (INR)	49.5/26.8
Market Cap (INR Mn)	25,372
Equity Shares Outstanding (Mn)	830.5

Shareholding Pattern (30th September, 2017)

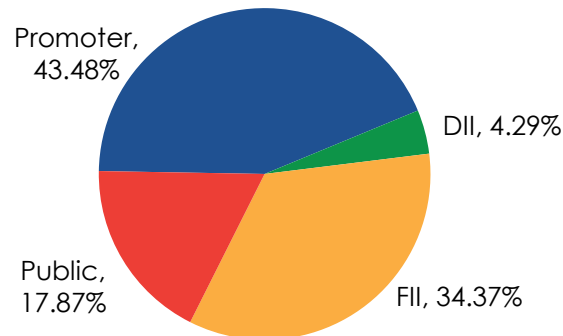

Hathway Cable and Datacom Ltd Disclaimer:

The information contained in this presentation is only current as of its date. All actions and statements made herein or otherwise shall be subject to the applicable laws and regulations as amended from time to time. There is no representation that all information relating to the context has been taken care off in the presentation and neither we undertake any obligation as to the regular updating of the information as a result of new information, future events or otherwise. We will accept no liability whatsoever for any loss arising directly or indirectly from the use of, reliance of any information contained in this presentation or for any omission of the information. The information shall not be distributed or used by any person or entity in any jurisdiction or countries were such distribution or use would be contrary to the applicable laws or Regulations. It is advised that prior to acting upon this presentation independent consultation / advise may be obtained and necessary due diligence, investigation etc may be done at your end. You may also contact us directly for any questions or clarifications at our end. This presentation contain certain statements of future expectations and other forward-looking statements, including those relating to our general business plans and strategy, our future financial condition and growth prospects, and future developments in our industry and our competitive and regulatory environment. In addition to statements which are forward looking by reason of context, the words 'may, will, should, expects, plans, intends, anticipates, believes, estimates, predicts, potential or continue and similar expressions identify forward looking statements. Actual results, performances or events may differ materially from these forward-looking statements including the plans, objectives, expectations, estimates and intentions expressed in forward looking statements due to a number of factors, including without limitation future changes or developments in our business, our competitive environment, telecommunications technology and application, and political, economic, legal and social conditions in India. It is cautioned that the foregoing list is not exhaustive This presentation is not being used in connection with any invitation of an offer or an offer of securities and should not be used as a basis for any investment decision

Valorem Advisors Disclaimer:

Valorem Advisors is an Independent Investor Relations Management Service company. This Presentation has been prepared by Valorem Advisors based on information and data which the Company considers reliable, but Valorem Advisors and the Company makes no representation or warranty, express or implied, whatsoever, and no reliance shall be placed on, the truth, accuracy, completeness, fairness and reasonableness of the contents of this Presentation. This Presentation may not be all inclusive and may not contain all of the information that you may consider material. Any liability in respect of the contents of, or any omission from, this Presentation is expressly excluded. Valorem Advisors also hereby certifies that the directors or employees of Valorem Advisors do not own any stock in personal or company capacity of the Company under review.

For further details, please feel free to contact our Investor Relations Representatives:



Mr. Anuj Sonpal
Valorem Advisors

Tel: +91-22-3006-7521 / 22 / 23 / 24

Email: hathway@valoremadvisors.com



Thank You

APRU	Average revenue per user
CAS	Conditional access system
DTH	Direct-to-home
DVR	Digital video recorder
DTT	Digital terrestrial TV
xDSL	Digital subscriber lines
FTA	Free-to-air TV
FTTx	Fiber-to-the-x, which refers to broadband network architecture that used optical fiber to provide last mile high-speed internet communication
LCO	Local cable operator
MSO	Multi-system cable operator
OTT	Over-the-top
PPV	Pay-per-view
STB	Set-top boxes
SVOD	Subscription-based video-on-demand, delivered via open (i.e. OTT) networks
TVOD	Transaction-based video-on-demand
UHD	Ultra-high definition TV
VAS	Value-added services
VOD	Video-on-demand